



HAL
open science

UWB SAW sensors and tags

Marc Lamothe, Victor Plessky, Jean-Michel Friedt, Sylvain Ballandras

► **To cite this version:**

Marc Lamothe, Victor Plessky, Jean-Michel Friedt, Sylvain Ballandras. UWB SAW sensors and tags. Acoustics 2012, Apr 2012, Nantes, France. hal-00811040

HAL Id: hal-00811040

<https://hal.science/hal-00811040>

Submitted on 23 Apr 2012

HAL is a multi-disciplinary open access archive for the deposit and dissemination of scientific research documents, whether they are published or not. The documents may come from teaching and research institutions in France or abroad, or from public or private research centers.

L'archive ouverte pluridisciplinaire **HAL**, est destinée au dépôt et à la diffusion de documents scientifiques de niveau recherche, publiés ou non, émanant des établissements d'enseignement et de recherche français ou étrangers, des laboratoires publics ou privés.



ACOUSTICS 2012

UWB SAW sensors and tags

M. Lamothe, V. Plessky, J.-M. Friedt and S. Ballandras

femto-st, 26 chemin de l'épitaphe, Equipe CoSyMa, 25000 Besançon, France

marc.lamothe@femto-st.fr

The radio Ultra Wide Band (UWB) technology brings many benefits with respect to the classical narrowband approaches such as extremely low power of emitted EM signals especially attractive for sensors for the medical world. For the SAW RFID tags and sensors the use of ultra wide frequency bands allows to get large number of codes on the chip and/or radically reduce the chip size. We have developed a prototype UWB SAW sensor device operating in a frequency range from 200 MHz to 400 MHz. The experimentally observed compressed pulse is about 5 ns long, which corresponds to theoretical expectations. Using LFM signals allows to get record low losses in the sensor and simplifies the signal processing algorithms. Delay time between compressed peaks is used to extract the temperature with a resolution better than 0.1°C. The sensor can have ID function due to different positions of reflectors and/or different dispersion of the LFM transducer. Remote interrogation with extremely low average power of μW level radiated by the “reader” is demonstrated.

1 Introduction

Nowadays RFID tags and remotely controlled sensors become omnipresent. Truly passive sensors and RFID tags based on Surface Acoustic Wave (SAW) technology can be interrogated at the distance up to 10m with radiated EM power of only about 10mW [1]. They operate on the following basic principles (Fig.1). A transceiver radio sends an interrogation signal which supplies energy to a passive sensor. The sensor is made of a piezoelectric transducer which converts electric energy into acoustic energy of SAW. The sensors architecture builds a response in form of reflected acoustic signal which contains such information as an identification number and/or a measured physical quantity. Arriving back to the transducer, this acoustic response is again converted to an electric signal sent by the same antenna (monostatic configuration) to the reader device where the information is deciphered.

Typically such systems use industry, scientific frequency bands (ISM) for which no license is required for operation with limited power levels in most of countries. The use of frequency bands is strictly regulated by governments and by international agreements on frequency allocations. The popular ISM bands are used by numerous communication systems which may interfere with remotely controlled sensors and RFID readers also using these bands.

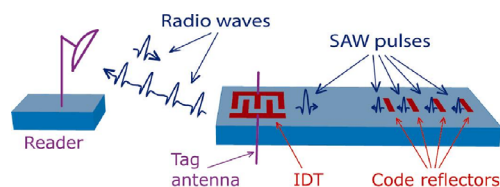

Figure 1: Operating principle of SAW RFID tag (*Ref: unknown source*).

The semiconductor FRID systems based on IC chips operate also in ISM bands and in order to reach the reading distance of a few meters they must radiate 4W to 10W of continuous EM power. That level of radiation can be incompatible, e.g., with medical applications demanding constant monitoring of a patient. Moreover, the narrow band systems are particularly sensitive to the environment in which they are used. The Ultra Wide Band (UWB) technology provide many attractive features [1,2,3] which we propose to use for SAW tags and sensors in this work to solve some of these problems.

Wider frequency spectrum B allows encoding more information, according to the Shannon formula (C is the information Capacity, S -signal power, N -noise power):

$$C = B \times T \times \log_2 \left(1 + \frac{S}{N} \right) \quad (1)$$

In SAW devices the delay time T is limited to a few μs because of propagation loss and the limited chip size. In 2.45 GHz ISM band we can use $B = 80$ MHz. There information capacitance of SAW tag is about 100-200 bit. But if we could use the frequency band B a few times wider, which is allowed by the UWB standards, the number of codes of SAW-tags could be radically increased, or decrease their size decreased, reducing the delay T . The UWB pulses can be much shorter in time and that results in smaller distance between reflectors and/or greater number of reflectors for coding the tag response.

Moreover, the signal processing can be partly performed within the tag - we can allocate a part of information capacitance for this purpose. In this case the tag is interrogated not directly by a short pulse but a much longer wide band pulse which can be compressed afterwards to a short signal of $\frac{1}{B}$ duration. With this approach the interrogation signal is modified by the tag and the response received by the reader is different from the initial interrogation signal, while the environmental echoes are not modified and remain copies of the interrogation pulse. The reader can discriminate the response of the tags from other parasitic reflections and the system becomes more robust to noise produced by the environment. Recently, standards appeared in the USA and Europe for UWB systems used for the commercial applications, which allocate frequencies and regulate power levels [4]. The standards demand drastically low level of the radiated power. For the USA standard, the power must not exceed -41.3 dBm/ MHz for some applications at frequencies >2 GHz suitable for SAW tags and sensors.

If the band $B=500$ MHz (2.0 GHz to 2.5 GHz) is used, the information capacitance of the SAW tag is increased many times compared narrowband devices and we need the same technology of optical photolithography to manufacture such devices as for SAW tags operating in 2.45 GHz ISM band.

To avoid technological difficulties in production of 2.5 GHz devices for the moment we have chosen to develop a UWB prototype temperature sensor operating in a lower frequency bands 200 MHz to 400 MHz but retaining the approaches of the UWB signal processing within the tag.

2 UWB signals in SAW-tags/ sensors

The information contained in a SAW sensor or tag is coded and transmitted to the reader with reflections from the mirrors. The better the time position of the reflections is known, the more precise the information delivered by the sensor is. The transducer is used to convert the electrical signal into an acoustic signal and vice-versa. The UWB approach allows operating with very narrow cross-correlation pulses thus in-

creasing the precision of the measured physical values.

2.1 Standard sensors

In standard SAW-tags and delay line sensors the duration of unit pulse $\frac{1}{B}$ corresponds to the used frequency band. That is every pulse carries 1 bit of information (if signal to noise ratio is about 1, $B \cdot T \approx 1$). Figure 2 illustrates such a delay line sensor. The difference of delays between reflected signals can be used for measurement of the temperature or other physical effects influencing propagation condition between these 2 reflectors, while cancelling the influence of the radio channel between the reader and the sensor. If the signal is strong more precise measurements can be obtained comparing the phase of the reflected signals. The phase and the amplitude of the responses can also be used for coding the ID number in SAW tags, however most often the pulse positioning coding scheme is used [5], wherein the whole time delay is subdivided into number of the time slots roughly equal to $\frac{1}{B}$, so that one response occupies in time domain one slot. One reflector can occupy a slot in a group of slots (usually 4 to 16 slots in group). The reader "knows" that it must find only one, the most strong, response in each group. Two or more reflectors with fixed position are used for calibration purposes, establishing a scale of slot positions independent of the temperature variations of delays. This coding scheme is now commonly accepted, because of simple and robust deciphering algorithm. However, the signals reflected by environment objects, such as walls are not distinguishable from the responses of reflectors. Therefore usually the initial delay of about $1 \mu s$ is introduced to guarantee that the environmental echoes die out to the time of arrival of the first response from the first reflector. That increases the length of device by 2 mm. Also, the narrower band is used, the longer is the duration of the interrogation pulses and, correspondingly the minimal slot size for one reflector. That makes the chip size of the device too long - around 6mm. In practical readers the interrogation in frequency domain is often a preferred option. The reader measures the reflected power remotely (similar to a frequency-sweep network analyzer) and all signal processing is done afterwards. Theoretically it is equivalent to using the pulses as described above, but practical realization is easier and cheaper for narrow band amplifiers and other electronic components.

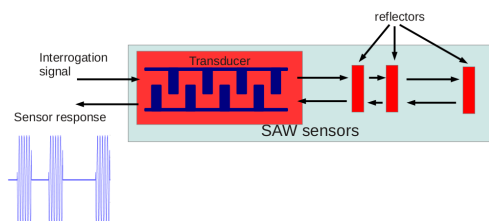

Figure 2: Standard sensors response.

2.2 UWB sensors

In the UWB tags and sensors, we use wide band dispersive transducer with $B \cdot T \gg 1$, $B \cdot T$ is about 100 in our case with Linear Frequency Modulation (LFM), which means that the transducer impulse response is a rather long pulse with duration T about 100 times longer than minimal time slot $\frac{1}{B}$

for a given frequency band. However, such pulse can always be compressed to the size of about $\frac{1}{B}$ on time scale (Figure 3), using "matched to a signal" filtering technique [6]. For example, to get the compressed electric pulses at the output the pulse incident in the InterDigit Transducer (IDT) must be inverted in time the impulse response of this IDT. At some moment of time all the sinusoids of the potential wave in the incident SAW will overlap ideally correctly the electrode structure, giving the δ function type of response. Its duration at -3 dB level is about $\frac{1}{B}$ [6]. For physical illustration of the device operation we can imagine that the dispersive LFM transducer is interrogated by ideally matched LFM signal (with an opposite sign of dispersion) and generates very short ($\frac{1}{B}$ long) SAW pulse with propagates to the reflectors, then after being partially reflected returns back and propagates along the IDT generating LFM response pulse. In the beginning of interrogation pulse (Fig.3) we generate low frequencies, while in the response pulse first high frequencies will come: the response pulse is inverted in time. The short SAW pulse is reflected by the reflector so reflectors positions are coded with pulse. The narrower the pulse, the more accurate the reflector position is known.

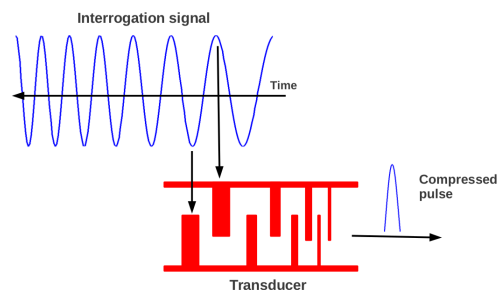

Figure 3: The interrogation signal compresses by IDT.

3 Prototype design

We have designed and manufactured two different prototypes with LFM interdigital transducers to study experimentally all main characteristics of such signal compression and to see main parameters demanding the optimization.

3.1 First prototype

The first prototype (Fig.4) is a two ports device. The input transducer is a dispersive LFM transducer (150 electrodes periods which sweeps frequency from 200 MHz to 400 MHz) to generate LFM SAW as an impulse response and the wideband output IDT with constant period transducer (only 3 electrodes for centre frequency 300 MHz). This first prototype allows direct measurement of the impulse response of the long IDT and thus the LFM pulse can be visualized and studied in details.

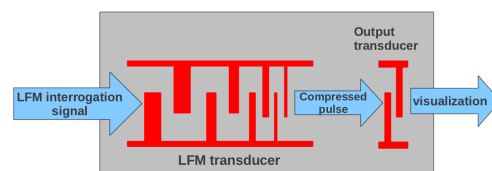

Figure 4: Two ports device prototype.

The Linear Frequency Modulation of the transducer follow this formula:

$$\omega = 2 \cdot \pi \cdot \left(f_0 - \frac{B}{T} \cdot t \right) \quad (2)$$

Wherein ω - is an instant frequency of the signal at the given moment of time t , f_0 - is the beginning frequency, B -band of the signal and T - its duration.

3.2 Second prototype

The second prototype (Fig.5) is a one port device. Its input and also output transducer is connected to the same dispersive LFM IDT. Three identical reflectors are situated in the acoustic channel to produce reflected responses which can be used for coding ID number, or to measure the temperature. Each reflector is composed of three open electrodes. The variation of the time delay between pulses produced by the reflectors can give the temperature information.

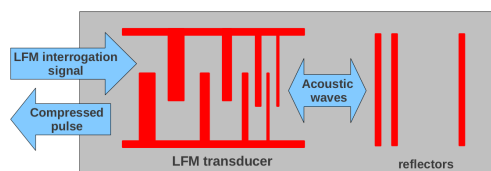

Figure 5: One port device prototype.

4 Building the compressed pulse

We first study both theoretically and experimentally the two ports prototype device to better understand the dispersive IDT characteristics. The device characteristics were obtained with the FEM/BEM simulation software FEMSAW and were measured with the networks analyzer.

4.1 Measurement and building the interrogation signal

The transducer finger periods vary linearly from 400 MHz to 200 MHz (counting from the side oriented to the 2nd IDT), but as the wave velocity on the free substrate surface is not exactly the same as on the surface with the electrodes, a phase shift from ideal LFM signal can appear. The optimum interrogation signal is not exactly an ideal linear FM chirp with frequencies from 200 MHz to 400 MHz because of this phase shift. However, we can use the impulse response in time domain which includes all said effects. The device was designed with sufficient delay between the 2 IDTs, so that we can separate and visualize experimentally the response of the LFM IDT (Fig.6). When the chirp signal is time-gated we can use it for simulation of the interrogation process. For that we first normalize its amplitude to a unit (like that we can see real loss level of the compressed signal) and reverse it in time (in order to create the perfect "matched-to-signal" filtering [6]) to obtain the optimum compressed pulse.

4.2 2-port device interrogation

So we have both simulated and measured transfer function $S_{12}(f)$ of the 2-port device. Transforming it into the

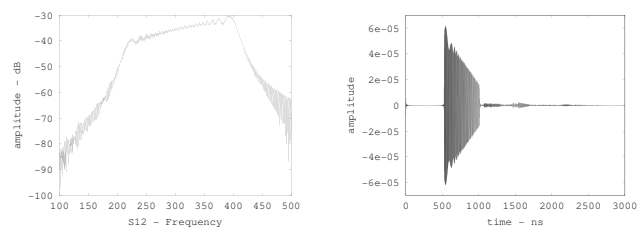

Figure 6: Extraction of the signal generated by the LFM transducer

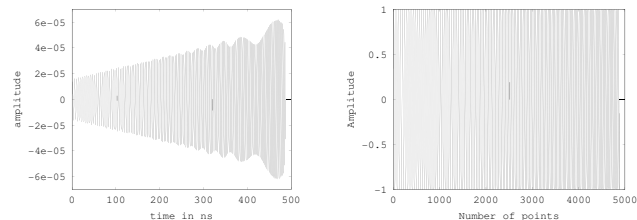

Figure 7: Reversion and normalization of the signals in the time domain

time domain and inverting the impulse response in time is obtained the signal ideally matched to the transducer, which can be used for the device interrogation. For that the transfer function $S_{12}(f)$ of our device is multiplied with the spectrum of the interrogation signal (in the frequency domain) and the result is reconverted into the time domain using IFFT.

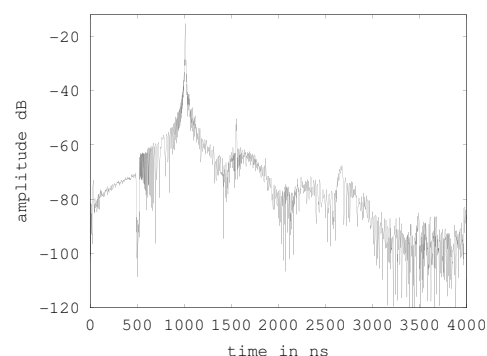

Figure 8: Compressed pulse with dB scale

The results (Fig. 8) obtained from simulated spectra and from the measured spectra are very similar. The compressed pulse amplitude is -16 dB for the simulation and the signal duration at the -3 dB is 4.7ns. For the measured spectrum we have the compressed pulse amplitude which varies between -15 dB and -18 dB with a compression to 4.8 ns. The signal compression and its amplitude are close to expected and the losses are low despite that there are only three electrodes which collect the energy of the compressed pulse on the second transducer.

5 Temperature measurements

Having characterized the transfer function of the IDT, we can try to use the second prototype (one ports devices) to measure the temperature. The second prototype comprises three reflectors (two responses are sufficient to measure the temperature). The three reflectors will reflect three com-

pressed pulses. The expansion of the substrate material, (128°-LiNbO_3) under the effect of temperature induces and a SAW velocity dependence on the temperature, changes the time delay between the echoes. Operations performed below were made with device characteristics measured with the networks analyzer. The interrogation signal was simulated as ideal LFM pulse with nominal delay $T = 500\text{ ns} \times 2$ and frequency band $B=200\text{ MHz}$, not really optimized to our experimental device.

5.1 Measurement of delays

The compressed pulses (Fig.10) are very narrow which simplifies exact determination of their position.

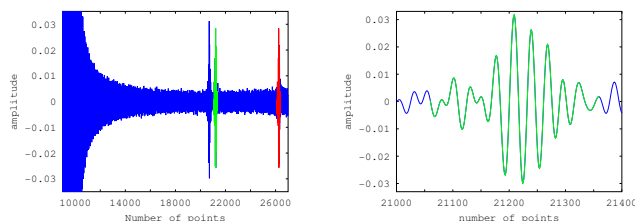

Figure 9: The three pulses: green colour marks is the second pulse, red- the third pulse

The goal is to find the temporal distance as accurately as possible between the second and third pulse. We accurately (Fig.10) superimposed second and third pulses, which give an accuracy of 10 fs for strong signals.

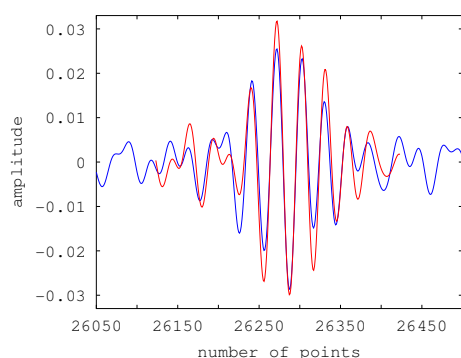

Figure 10: Superimposed second on third signals.

5.2 Experimental measurement of temperature with wired sensor

The sensor has been subjected to increasing and decreasing ramps ranging from -5° C to 130° C with a step of 5° C . The sensor was placed in an oven, and a network analyzer measured its $S_{11}(f)$ spectrum. All the processing steps described above were used to obtain the temperature information. Magenta curve is the climatic chamber reference sensor (Pt100). Blue curve is the prototype sensor. The blue curve is not exactly superimposed on the magenta curve across all the temperature range because the lithium niobate has slightly non linear dependence of the delay time on temperature. The effect of the nonlinearity will be corrected by the reader algorithm. The important result is that each level (increasing or decreasing, no hysteresis) measure always the same temperature with an accuracy of 0.2° C .

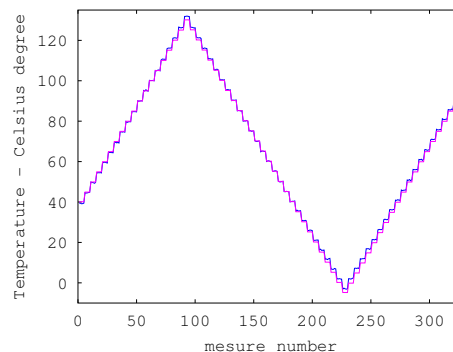

Figure 11: Magenta curve is for an oven reference sensor, blue curve corresponds to the sensors prototype.

6 Remote interrogation

There are many different ways to interrogate the sensors remotely. The popular method consists to interrogate the sensor like it does any networks analyzer, that is to measure remotely the reflection parameter. This approach is often realized for SAW-tag interrogation [7]. This approach gives excellent sensitivity and, correspondingly, long reading distance, but the reader is relatively slow. In our case of UWB signals, the approach is applicable and the only difference would be in post- processing of the signals. Basically it would be the same procedure as described above but instead of wired measurement of the $S_{12}(f)$ we would do it remotely.

It is also possible to interrogate the sensor with short pulses. In our case we can interrogate the sensor with a specific chirp signal frequency of which sweeps the frequency range 200 MHz to 400 MHz.

This method should provide very fast measurements but requires the development of an UWB - LFM radar. Instead we used a function signal generator (Tektronix AWG7122B Arbitrary Waveform Generator). The device allows to generate an interrogation signal of an arbitrary form, for example to use measured and inversed in time impulse response of the 2-port device, or generate ideal LFM signal, that is we can physically realize the interrogation process and pulse compression instead of mathematical processing of $S_{11}(f)$ responses with Fourier transformations to the time domain and vice-versa.

This method is less good than the first one because it requires the use of broadband amplifiers and so will be more sensitive to noise.

6.1 Remote interrogation setup

The setup presented in Fig.14 was used for the remote interrogation of the 1-port device. The function generator generates two signals. The first one is a chirp signal to interrogate the sensor and the second one is a controlling signal which is sent on a switch, either in reception or interrogation mode. The switch (ZASWA-2-50dr+) toggles the single port sensor in reception mode, when connected to the function generator, and transmit mode when connected to the oscilloscope. The oscilloscope displays the signal generated by the sensor (Fig. 16, three pulses). The amplifiers are not represented in the Figure.

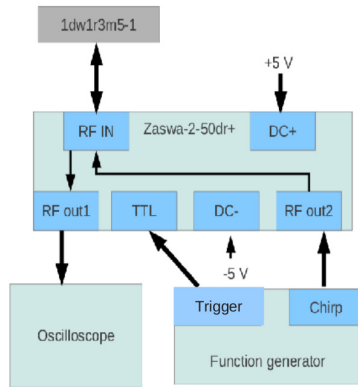

Figure 12: Sensors (1dw1r3m5-1) remote interrogation principle

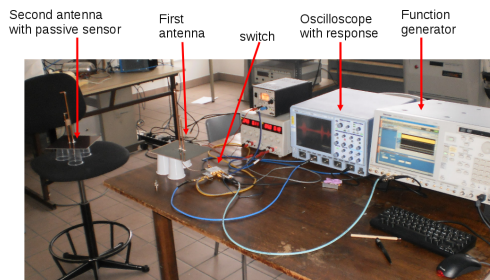

Figure 13: Remote interrogation

6.2 Measurement results for 1 meter distance

The interrogation signal lasts $1\mu\text{s}$ and has a power of about 100mW . The pulse observed is an average of 64 measurement per second. The average power thus supplied to antenna is in range of $10\mu\text{W}$. ($100\text{mW} \cdot 1\mu\text{s} \cdot \frac{64}{1\text{s}} = 0.1 \cdot 10^{-6} \cdot 64 = 6.4 \cdot 10^{-6} = 6.4\mu\text{W}$).

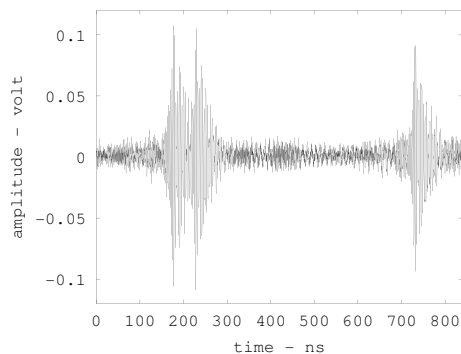

Figure 14: Remote interrogation - response pulses

We have not found commercial broadband antennas operating between 200 MHz to 400 MHz. Therefore we have built home made antennas which are rather poorly optimized [8]. The antennas have the bandwidth closer to 100 MHz instead of optimal 200 MHz, thus reducing the frequency spectrum of transmitted and received signals. This can be one of the reasons why the echoes have not achieved good time compression. However the responses are clearly seen with record low average interrogation power.

7 Conclusion

The designed prototype of UWB SAW sensors demonstrate high accuracy temperature measurements for wired sensors, and reliable signal measurements for remote interrogation with extremely low average power supplied to antenna. Further improvements are expected for optimized sensor designs, interrogation signals matched to IDTs and improved antennas. Interrogation in frequency domain (measuring returned power remotely) will further increase the sensor accuracy and the reading distance. For SAW-tags, extremely narrow compressed signals open possibility of radical increase of the code capacitance and radical reduction of chip size of the device.

8 Acknowledgments

The work is performed in the frame of “2010 Chaîre d’Excellence” project from the French National Research Agency (ANR).

References

- [1] V. Plessky, L. Reindl, “Review on SAW RFID tags”, *IEEE Trans. On UFFC*, V.57, No 3, 654-668 (2010)
- [2] D. Porcino, W. Hirt, “Ultra-wideband radio technology: potential and challenges ahead”, *IEEE Communications Magazine* 41, 66 (203)
- [3] S. Harma, V. Plessky, “Surface Acoustic Wave RFID Tags”, *Development and Implementation of RFID Technology*, Book edited by: Cristina TURCU ISBN 978-3-902613-54-7, 554 (February 2009) I-Tech, Vienna, Austria
- [4] G. Breed, “A summary of FCC rules for ultra wideband communications”, *High Frequency Electronics* 4, 42-44 (2005)
- [5] V. Plessky, S. N. Kondratiev, R. Stierlin, and F. Nyreler, “SAW tags: new ideas”, in *Proc. 1995 IEEE Ultrasonics Symposium*, 117-120 (1995)
- [6] D. Morgan, “Surface acoustic wave filters, second edition”, *Amsterdam: Elsevier*, 220-222 (1991)
- [7] L. Reindl, G. Scholl, T. Ostertag, H. Scherr, U. Wolff, F. Schmidt, “Theory and application of passive SAW radio transponders as sensors”, *IEEE Trans. Ultrason., Ferroelect., Freq. Contr.*, vol. 45, 1281-1292 (Sep. 1998)
- [8] R. Clarke, R. Karunaratne, C. Schrader, R. Kwok, “Ultra-Wideband Antenna”, (2004)