



HAL
open science

Automatic recognition of the components of a Hybrid FE-SEA model

Louis Kovalevsky, Robin S Langley

► **To cite this version:**

Louis Kovalevsky, Robin S Langley. Automatic recognition of the components of a Hybrid FE-SEA model. Acoustics 2012, Apr 2012, Nantes, France. hal-00810923

HAL Id: hal-00810923

<https://hal.science/hal-00810923>

Submitted on 23 Apr 2012

HAL is a multi-disciplinary open access archive for the deposit and dissemination of scientific research documents, whether they are published or not. The documents may come from teaching and research institutions in France or abroad, or from public or private research centers.

L'archive ouverte pluridisciplinaire **HAL**, est destinée au dépôt et à la diffusion de documents scientifiques de niveau recherche, publiés ou non, émanant des établissements d'enseignement et de recherche français ou étrangers, des laboratoires publics ou privés.



ACOUSTICS 2012

Automatic recognition of the components of a Hybrid FE-SEA model

L. Kovalevsky and R.S. Langley

University of Cambridge, Engineering Department, Trumpington street, cb21pz Cambridge,
UK
lk315@cam.ac.uk

The hybrid finite element/statistical energy analysis (FE/SEA) method [1,2] is a vibro-acoustic analysis approach based on a non-parametric model of uncertainty. It allows the prediction of the ensemble mean and variance of the response of a complex built-up system across a large range of frequencies, with a small number of degrees-of-freedom, and without the use of Monte-Carlo simulations. This approach considers the structure as an assembly of fully deterministic components, modelled using FE, and highly random components, which are modelled with SEA, and a diffuse field reciprocity relation is used to effect coupling between the components. The main difficulty of this method is the choice of the different components. The work presented here addresses this issue. The aim is to develop an algorithm that can automatically recognise the SEA and FE components in a hybrid model based on a relatively coarse-mesh finite element model.

1 Introduction

In the design of engineering structures that are sensitive to manufacturing imperfections (for example, cars from a production line) it is ideally required to predict the statistics of the response across the ensemble of manufactured systems. This is particularly true for the high frequency response, where the manufacturing imperfections are commensurate with the length scale of deformation producing a high sensitivity to uncertainty.

Standard analysis techniques for acoustics and vibration, such as the Finite Element Method (FE) and the Boundary Element Method (BEM), are well suited to the analysis of the response of a system in the low frequency range. However, as the frequency increases, the number of degrees of freedom required to capture the dynamic behaviour of the system components rises, producing large computational times, even without accounting for uncertainty. These considerations have led to the development of alternative analysis methods which account for uncertainties while also requiring a reduced number of degrees of freedom in the high frequency range. One such method is Statistical Energy Analysis (SEA), a probabilistic method based on the analysis of vibrational energy flow within the system. The applicability of the SEA method is usually limited to higher frequencies because of the underlying assumptions, specifically that each structural component is sufficiently random and that the coupling between subsystems (i.e. different regions of the system) is sufficiently weak. Between the respective ranges of validity of FE and SEA there is a "mid-frequency" region, and much research effort has been directed at the development of efficient analytical methods that can be applied in this range.

Over the last decade a hybrid finite element (FE)/statistical energy analysis (SEA) method based on non-parametric modelling of uncertainty has been developed. This method provides an efficient way of combining the strength of the two well established techniques, and allows the prediction of the ensemble mean and ensemble variance response of complex built-up structures across a broad frequency range. Within this approach the structure is considered as an assembly of fully deterministic components, modelled via FE, and highly random components, described with SEA, and the coupling of the two methods is achieved via the diffuse field reciprocity relation. The hybrid FE-SEA method is available in the commercial software package VA ONE. In recent years many industrial users have applied VA ONE to a variety of vibro-acoustic problems (aerospace,

automotive, etc.) validating the approach against experimental results and showing good prediction accuracy. But the main difficulty of the method is the choice of the different subsystems and the master system.

The aim of this work is to develop an automatic method whereby the subsystems and the master system in a hybrid model can be identified from a finite element model. This problem has previously been addressed for purely SEA models by Totaro and Guyader [3] and by Gagliardini et al [4], and the algorithms that have been employed are described briefly below.

(i) The method of Totaro and Guyader [3] consists of applying an excitation to the structure (typically a point load) and then calculating the energy density at a grid of points over the structure at a number of frequencies within a specified band. A rectangular energy matrix is then constructed in which the rows correspond to the grid points and the columns correspond to the frequencies. Each entry of the matrix is given by the energy density of the relevant grid point at the relevant frequency, minus the average of the grid point energies at that frequency (i.e. the deviation of the grid point energy density from the mean). This matrix is then multiplied by its transpose to yield a square symmetric matrix with dimension equal to the number of frequencies. The eigenvalues and eigenvectors of this matrix are found, and ranked in order of decreasing eigenvalue. The energy matrix is then post multiplied by the eigenvector matrix, and the resulting matrix is called the "PCP" matrix: the ij th entry of this matrix refers to the i th grid point, and the numerical value is equal to the scalar product of the frequency dependency of the energy at this point with the j^{th} eigenvector. The aim of the method is then to "cluster" the grid points into groups that have a similar dependency on the first few eigenvectors (i.e. groups with similar rows in the PCP matrix). These clusters are then identified as the SEA subsystems. The above description refers to only one excitation point, but the method is normally extended by calculating the PCP matrix for a number of excitation points, and then producing a combined matrix by representing each matrix as a set of columns in a larger matrix. Physically this method identifies subsystems by looking for grid points that display a similar dependency on frequency.

(ii) The method of Gagliardini et al [4] is based on selecting a number of grid points on the finite element model and then computing the modulus squared Green's function between each pair of grid points, averaged over a specified frequency band. The resulting functions are expressed as the entries of a matrix. An iterative algorithm

is then employed to try and identify groups of grid points in the system that are strongly coupled to each other but weakly coupled to other groups. The authors state “unfortunately the optimization process may never converge, and some of the points may remain definitely unstable. Further work is required to identify robust convergence criteria.” Although the method has a clear physical basis, it appears that it can be complicated and numerically expensive to apply.

In what follows the aim is to develop an identification method which is conceptually simple and relatively numerically efficient and stable.

2 Identification method

2.1 Definition and properties of the \mathbf{A} matrix

Given a finite element model of the system, the modes of the system can be computed and then projected onto a grid of points distributed over the model, and the set of Green’s functions between any two points i and j can then be written in the form :

$$g_{ij}^{kl} = \sum_n \frac{i\omega\phi_{in}^k\phi_{jn}^l}{-\omega^2 + \omega_n^2(1+i\eta)} = (\Phi^k H \Phi^l)_{ij} \quad (1)$$

where g_{ij}^{kl} is the velocity in direction k at point i caused by a point load applied in direction l at point j . The term ϕ_{in}^k represents the value of mode n in direction k at node i , and ω_n is the n th natural frequency. It is implied in Eq. (1) that the damping is proportional with loss factor η , although this assumption can be changed if required. The entries of the matrices employed in the final part of equation (1) are readily deduced. A matrix \mathbf{A} is now defined as :

$$A_{ij} = \frac{1}{\Delta} \int_{\Delta} \sum_{k,l=1}^3 |g_{ij}^{kl}|^2 d\omega \quad (2)$$

which represents the modulus squared Green’s function averaged over force and response directions and over a frequency band Δ .

The following approach is based on the premise that a system comprised of “perfect” *uncoupled* SEA subsystems would have an \mathbf{A} matrix with the structure

$$\mathbf{A} = \begin{bmatrix} A_1 & 0 & \dots & \dots \\ 0 & A_2 & \dots & \dots \\ \vdots & \vdots & \ddots & \vdots \\ \vdots & \vdots & \dots & A_n \end{bmatrix} \quad (3)$$

where each entry of the sub-block \mathbf{A}_j is identical, i.e.

$$\mathbf{A}_j = \begin{bmatrix} a_j & a_j & a_j & a_j \\ a_j & a_j & a_j & a_j \\ a_j & a_j & a_j & a_j \\ a_j & a_j & a_j & a_j \end{bmatrix} \quad (4)$$

Equation (3) and (4) imply that the response of each subsystem is homogeneous, regardless of which point in the subsystem is subjected to excitation. The matrix \mathbf{A}_j has only one non-zero eigenvalue, and the corresponding eigenvector has identical entries. The matrix \mathbf{A} therefore has n non-zero eigenvalues, and the corresponding eigenvectors have the form

$$\begin{bmatrix} 1 \\ 0 \\ \vdots \\ 0 \end{bmatrix}, \begin{bmatrix} 0 \\ 1 \\ \vdots \\ 0 \end{bmatrix}, \dots, \begin{bmatrix} 0 \\ 0 \\ \vdots \\ 1 \end{bmatrix} \quad (5)$$

In such a “perfect” system, the spatial domain of the subsystems can readily be identified by examining the eigenvectors associated with the non-zero eigenvalues (note that, depending on the grid numbering scheme, the matrix \mathbf{A} may be shuffled and it may be non-trivial to identify the subsystems from \mathbf{A} itself). If the system is “non-perfect”, then each sub-block of \mathbf{A} will have non-constant values, and couplings between the sub-blocks will occur. Nonetheless, a similar eigenvalue/eigenvector structure would be expected: i.e. there should be a limited number of large eigenvalues, corresponding to the number of subsystems, and the associated eigenvectors should be approximately homogeneous and localized to a particular subsystem.

2.2 Identification of the significant eigenvectors

The above reasoning suggests that the subsystems in a model can be identified from the appropriate eigenvectors of the matrix \mathbf{A} . The question is then how to identify these eigenvectors. In [5], it is shown that the best ranking is obtained by :

- (i) ranking the eigenvectors of \mathbf{A} according to the modulus of the mean value of the eigenvector entries (having scaled each eigenvector to have a unit norm). An eigenvector is then retained in the analysis if the modulus of the mean value is greater than $N\%$ of that of the highest ranked eigenvector. Typically N is set at around 10%.
- (ii) reranking the retained eigenvectors according to a parameter m_j defined as

$$m_j = \max \left\{ \frac{1}{4} \sum_j (x_j + |x_j|)^2, \frac{1}{4} \sum_j (x_j - |x_j|)^2 \right\} \quad (6)$$

Step (i) identifies eigenvectors which tend to be localised to particular regions of the system, while step (ii) helps to reject localised eigenvectors which are oscillatory, and therefore not similar to those in equation (5).

2.3 Identification of the components of a hybrid FE/SEA model

Two different strategies could be used to identify the components of a hybrid model using the eigenvectors selected using the ranking process described in section 2.2. The first strategy presented in [5] is:

Strategy A:

```

1  retain the top M re-ranked eigenvectors such
   as  $m_j > m$ ;
2  for each node
3    find the eigenvector  $e$  with the greatest
   modulus at this grid point;
4    if the value of the eigenvector at the grid
   point is less than a small  $X\%$  of its maximum
   entry
5      assign this node to the master system;
6    else
7      assign this node to the subsystem  $e$ ;
8    endif
9  endfor

```

The alternative strategy is:

Strategy B:

```

1  stop=0; e=1;
2  while stop=0
3    find the list of nodes for which the value
   of modulus of the eigenvector  $e$  is the
   greater than  $X\%$  of its maximum entry;
4    remove from this list any node already
   assigned to a subsystem;
5    if the list is not empty
6      assign all the nodes in the list to the
   subsystem  $e$ ;
7      e=e+1;
8    else
9      stop=1;
10   endif
11  endwhile

```

As can be seen, the identification based on strategy A requires three parameters N , M and X , whereas the one based on strategy B requires only two parameters N and X . The parameter M could be sought as an *a priori* input of the number of SEA components. In practice, M is set up such that all the retained eigenvectors have a value of m_j higher than a given value m , and a reasonable value for m is 0.8. This value depends on the problem considered. Strategy B might be more robust in the sense that the number of subsystems is automatically identified, since the algorithm stops as soon as an eigenvector is not associated with a subsystem.

3 Numerical examples

In this section the two different identification strategies are compared on two examples of increasing complexity.

3.1 Plate-stiffener structure

This example structure, shown in Figure 1, is made from aluminium, and the stiffeners are 5cm high and 10mm thick; the system is simply supported over the two shorter ends. The structure has 337 modes below 2kHz, and the A matrix has been computed over the frequency band 1.5kHz to 2kHz, with frequency averaging being performed by

considering 100 distinct frequencies. A loss factor of 0.1 has been applied in the forced response calculations.

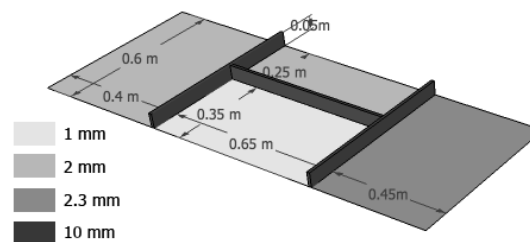

Figure 1: Plate-stiffener structure

The results of the identification, obtain with the strategy B, are presented in Figure 2. As can be seen, the results are consistent with expectations in the sense that each distinct panel is identified as a subsystem, and the master system is limited to the stiffeners.

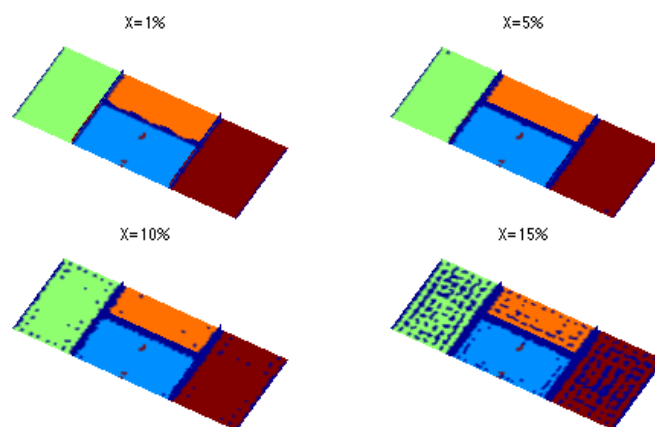

Figure 2: Identified components for $X=1, 5, 10$ and 20%

Figure 3 shows the measure m_j versus the rank of the eigenvector of the matrix A according to the modulus of the mean value. On this figure, one can also see the number of modes selected according to the value N (defined in section 2.2). Moreover, the red dots correspond to the eigenvectors used in strategy B. Therefore, for any value of m between 0.65 and 0.82, and any value of N between 5% and 20%, the strategies A and B lead the same set of eigenvectors. One can remark a group of eigenvectors with an m_j value equal to 1; these eigenvectors are localized in one element and are a numerical artefact due to the relatively coarse FE mesh used.

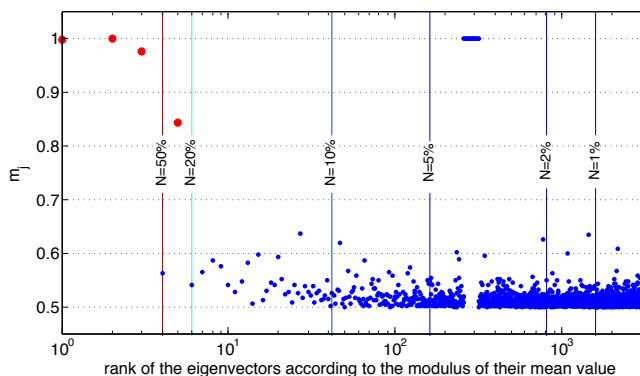

Figure 3: Measure m_j versus the rank of the eigenvector of the matrix A according to the modulus of their mean value

3.2 Aircraft section

The aircraft section structure considered as the second example is shown in Figure 4. The exterior shell is connected to the frame by a rigid connection. The interior shell is mounted on the frame by 12 isolators. The whole FE model employed to compute the modes of vibration has 51150 degrees of freedom. The system has 217 modes of vibration below 500Hz, and the identification algorithm was run for the frequency range 250 to 500 Hz, with 250 distinct frequencies in the frequency average calculation. The loss factor was set to 0.1 in the forced response calculations.

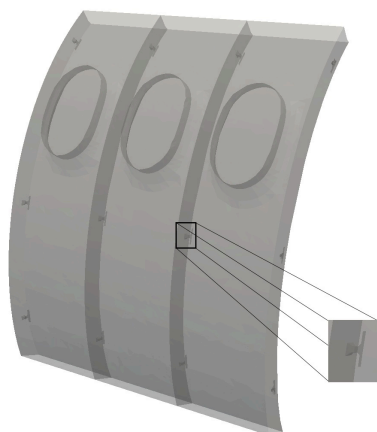

Figure 4: View of the aircraft section

The figure 5 shows the measure m_j versus the rank of the eigenvectors according to the modulus of the mean value. As can be seen, in this example it is difficult to isolate a group of eigenvectors with high m_j values. Moreover, contrary to the previous example, the parameter N has a great importance in the selection of the eigenvectors. In this case, N is chosen to retain all of the eigenvectors. Finally, the red dots in the figure correspond to the eigenvectors used in strategy B.

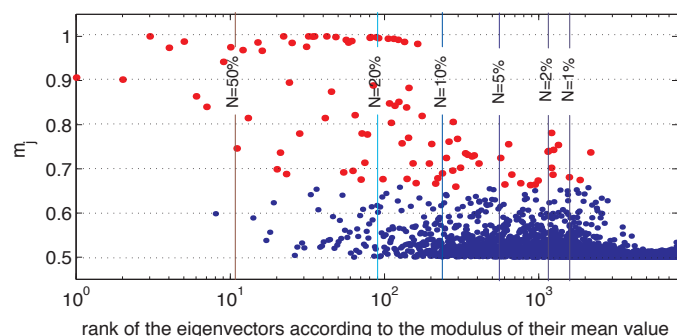

Figure 5: Measure m_j versus the rank of the eigenvector of the matrix A according to the modulus of their mean value

The subsystems identified using algorithm A (described in section 2.3) for $X=10\%$ and algorithm B are shown respectively in Figures 6 and 7. The identification of the master system (colored in black in Figures 6 and 7) is

compatible with the stiffness of the different components; the master system should include the connection area between the stiffener and the skin (interior and exterior), the exterior glass windows, and the area of the skins around the three windows. As can be seen, in this example strategy B gives a “cleaner” master system. As mentioned previously, the algorithm automatically selects the number of eigenvectors to be employed.

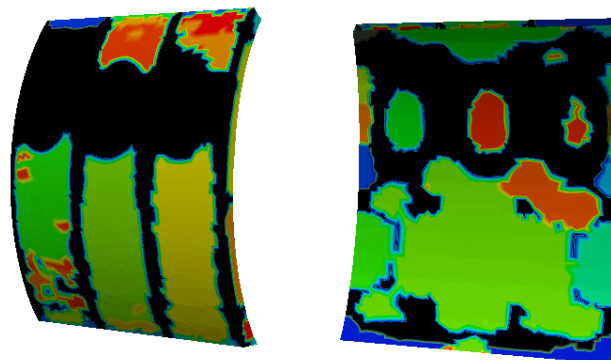

Figure 6: resulting master system (black) and SEA subsystem (color) using the algorithm A with $M=0.7$ and $X=10\%$

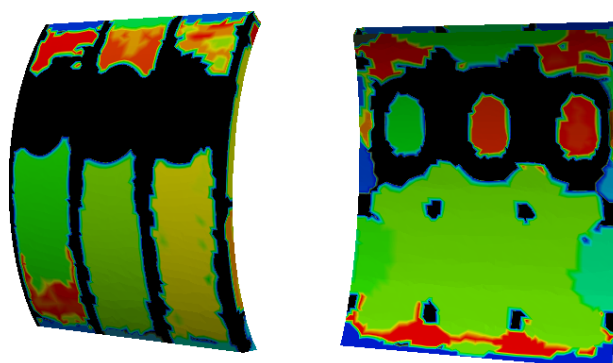

Figure 7: resulting master system (black) and SEA subsystem (color) using the algorithm B with $X=10\%$

The identification of the SEA subsystems is not as clean as in the previous example. For the exterior skin (where around six subsystems would be expected, above and below the windows and between the stiffeners) the algorithm found more than eleven subsystems, with some of them interlaced. The decomposition of the interior skin is less easy to predict a priori. Three possibilities might be imagined: six subsystems similar to the outer skin; two subsystems, representing a single subsystem above the windows and one below the windows; one single subsystem. The computed results show closest resemblance to the final possibility.

The resulting identification could be used as a guide in creating a hybrid FE-SEA model, rather than a method of automatically generating a model. Furthermore, the results obtained from the identification algorithm can be simplified by the application of a suitable post-processing method. This operation is based on the proposition that the SEA subsystems have to be simply connected. Therefore the idea is, first, to consider that the master system has been properly identified, and then, to decompose the complementary part of the structure into simply connected domains, each of which represents an SEA subsystem. The

result of such an operation is shown on figure 8 using the result of the strategy B. As can be seen, the resulting decomposition is much cleaner than the original version.

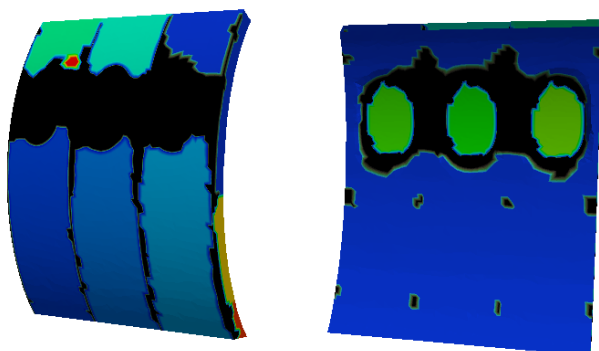

Figure 8: post processing of the identified subsystem using strategy B

4 Conclusion

The suggested selection algorithm is very promising as it gives a clear identification of the master system of the potential hybrid model. The identification of the SEA subsystems seems also to be promising but further tests on a wider range of structures are warranted. The method is significantly simpler than previous algorithms and has the scope for further development – for example, scaling of the A matrix, or the use of alternative methods of eigenvector selection and component identification, or using the A matrix to identify the equivalent SEA matrix.

Acknowledgments

The authors gratefully acknowledge the ITN Marie Curie project GA-214909 "MID-FREQUENCY - CAE Methodologies for Mid-Frequency Analysis in Vibration and Acoustics".

References

- [1] P.J. Shorter and R.S. Langley, Vibro-acoustic analysis of complex systems, *Journal of Sound and Vibration*, 288, 669-700, (2005).
- [2] R.S. Langley and V. Cotoni, Response variance prediction for uncertain vibro-acoustic system using a hybrid deterministic-statistical method, *Journal of the Acoustical Society of America*, 122, 3445-3463, (2007).
- [3] N. Totaro and J.L. Guyader. SEA substructuring using cluster analysis: the MIR index. *Journal of Sound and Vibration*, 290, 264-289. (2006).
- [4] L. Gagliardini, L. Houillon, G. Borello and L. Petrinelli (2005), Virtual SEA-FEA-based modeling of mid-frequency structure-borne noise. *Sound and Vibration*, 22-28, (2005).
- [5] R.S. Langley and L. Kovalevsky, Automatic recognition of the components of a hybrid FE-SEA model from a finite element model. *Proceeding at NOVEM 2012 conference*. (2012).