



HAL
open science

Advanced control for modifying the acoustic impedance at the diaphragm of a loudspeaker

Romain Boulandet, Hervé Lissek, Etienne Rivet

► To cite this version:

Romain Boulandet, Hervé Lissek, Etienne Rivet. Advanced control for modifying the acoustic impedance at the diaphragm of a loudspeaker. Acoustics 2012, Apr 2012, Nantes, France. hal-00810907

HAL Id: hal-00810907

<https://hal.science/hal-00810907>

Submitted on 23 Apr 2012

HAL is a multi-disciplinary open access archive for the deposit and dissemination of scientific research documents, whether they are published or not. The documents may come from teaching and research institutions in France or abroad, or from public or private research centers.

L'archive ouverte pluridisciplinaire **HAL**, est destinée au dépôt et à la diffusion de documents scientifiques de niveau recherche, publiés ou non, émanant des établissements d'enseignement et de recherche français ou étrangers, des laboratoires publics ou privés.



ACOUSTICS 2012

Advanced control for modifying the acoustic impedance at the diaphragm of a loudspeaker

R. Boulandet, H. Lissek and E. Rivet

Ecole Polytechnique Fédérale de Lausanne, EPFL STI IEL LEMA, 1015 Lausanne,
Switzerland
romain.boulandet@epfl.ch

The treatment of low-frequency sound fields can be addressed efficiently through acoustic impedance control. The diaphragm of electroacoustic transducers is used as refracting surface that controls the reaction of some boundaries of the sound field. The general idea is to absorb the incident sound energy or to contain it, simply by altering the transducer dynamics in a controlled fashion. Usual techniques operate either by feedback control of acoustic variables (sound pressure or velocity) or by connecting some electrical load at the transducer terminals. The paper focuses on how to transform a direct-radiating electrodynamic loudspeaker in an active electroacoustic resonator. Through the use of sensors and controller, it is discussed how to achieve broadband sound absorption at the transducer diaphragm. The phase compensation technique is also introduced as a convenient way to overcome a practical issue that may arise in some cases, taking the form of an over-reflective behavior of the diaphragm. For illustrative purposes, computed results and measurements obtained in impedance tube are provided to show the performance of a controlled loudspeaker in terms of acoustic absorption capability and stability.

1 Introduction

This research is part of an effort to improve the acoustics in the listening rooms, especially when the usual passive soundproofing means are not satisfying. Increasingly often, rooms must accommodate various activities (theater, concert, conference, etc.) with very different acoustic requirements, and sometimes conflicting [1, 2]. In the case of instrumental music for instance, it is better to promote sound reflection on the walls and therefore the natural reverberation of the room, while for other activities involving speech (theaters, conference, etc.) the inverse would be preferable. Current needs are therefore development of efficient and versatile soundproofing means in order to absorb, or reflect, part of the incident acoustic energy. Ideally, the use of wall coverings that could change at will the sound environment to suit activity would offer great promise for improving listening quality in multi-purpose rooms.

The paper focuses on how to transform an electrodynamic loudspeaker in an active electroacoustic resonator [3]. By involving sensors and control system, it is discussed how to achieve broadband sound absorption at the transducer diaphragm. The phase compensation technique is also introduced as a convenient way to overcome a practical issue that may arise in some cases, taking the form of an over-reflective behavior of the diaphragm. For illustrative purposes, computed results and measurements obtained in impedance tube are provided to show the performance of a controlled loudspeaker in terms of acoustic absorption capability and system stability.

2 Electroacoustic resonators

2.1 Governing equations

For small displacements and below the first modal frequency of the diaphragm, the generalized governing equations of a direct-radiator electrodynamic loudspeaker system can be obtained after Newton's second law and Kirchoff's circuit law [4]. With the use of Laplace transform, the characteristic equations of the transducer can be expressed as

$$\begin{aligned} SP(s) &= \left(sM_{ms} + R_{ms} + \frac{1}{sC_{mc}} \right) V(s) - BLI(s) \\ E(s) &= (sL_e + R_e)I(s) + BLV(s) \end{aligned} \quad (1)$$

where $P(s)$ is the driving sound pressure acting on the transducer diaphragm, $V(s)$ is the diaphragm velocity, $I(s)$ the driving current and $E(s)$ is the voltage applied at the electrical terminals (cf. Fig. 1). For the model parameters, S is

the effective piston area, Bl is the force factor of the transducer (product of B , the magnetic field amplitude and l , the length of the wire in the voice coil), M_{ms} and R_{ms} are the mass and mechanical resistance of the moving body, R_e and L_e are the dc resistance and the inductance of the voice coil, respectively.

Here, $C_{mc} = (1/C_{ms} + \rho c^2/V_b)^{-1}$ is the equivalent mechanical compliance accounting for both the flexible edge suspension and spider of the loudspeaker C_{ms} and the enclosure, where ρ and c are the density and celerity of air and V_b is the volume of the enclosure. The coupling term $BLI(s)$ is the Laplace force induced by the current circulating through the coil, and $BLV(s)$ is the back electromotive force induced by the motion of the coil within the magnetic field. Table 1 summarizes the small signal parameters of the low-range Monacor SPH-300TC loudspeaker used in the experiments.

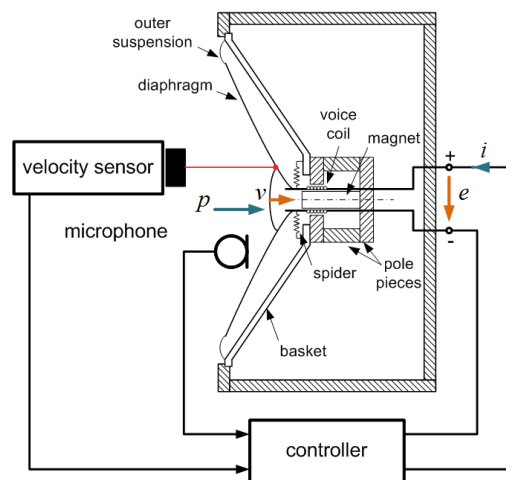

Figure 1: Schematic of an electrodynamic loudspeaker under feedback control.

The nature of applied voltage e has to be specified in order to provide a complete description of the loudspeaker system. When applying feedback control the amplifier from which the voice coil is actuated is commonly described as a Thévenin equivalent source

$$E(s) = E_g(s) - Z_L(s)I(s) \quad (2)$$

where E_g is an auxiliary source voltage and Z_L is its internal impedance. In case of a simple feedback control of sound pressure and diaphragm velocity, Eq. (2) can be reduced to

$$E(s) = \Gamma_p P(s) - \Gamma_v V(s) \quad (3)$$

where Γ_p and Γ_v are proportional gains.

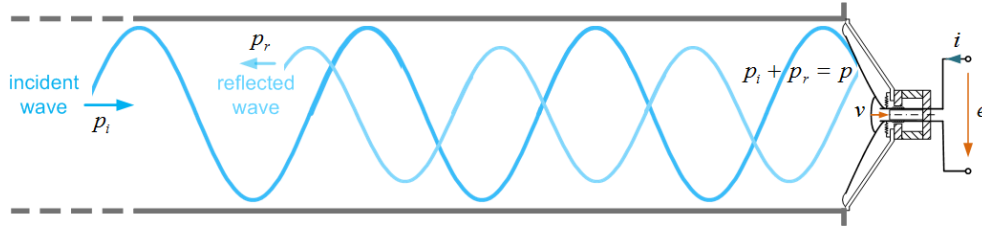

Figure 2: Sound wave propagating in a semi-finite duct that is ended by a loudspeaker. The signal p_i is the incident sound wave from a source at infinity and p_r is the wave reflected at the diaphragm.

2.2 Direct control of acoustic impedance

Let us consider an unplugged loudspeaker at one end of a semi infinite duct where plane waves propagate as depicted in Fig. 2. When subjected to a surrounding sound field the diaphragm will oscillate in sympathy with incident sound waves. The resulting sound pressure acting on the diaphragm can be written as

$$p = p_i + p_r = (1 + r)p_i = \frac{2Z_s}{Z_s + Z_c} p_i \quad (4)$$

where p_i and p_r are the amplitude of incident and reflected sound waves, respectively, r is the reflection coefficient, $Z_s = p/v$ is the specific acoustic impedance of the diaphragm and $Z_c = \rho c$ is the characteristic impedance of air.

After some further manipulations, the total pressure at the transducer diaphragm can be expressed as

$$p + \rho c v = 2p_i \quad (5)$$

Equation (5) identifies a straightforward relationship between incident sound waves, driving sound pressure, and resulting velocity at the diaphragm. In order to provide perfect sound absorption, i.e. $r = 0$, the relationship between the driving sound pressure and resulting diaphragm velocity should be

$$v = \frac{p}{\rho c} \quad (6)$$

If the diaphragm velocity can be controlled to satisfy Eq. (6), then $p = p_i$ and incident sound waves do not see impedance mismatch (or discontinuity) at the interface with air. There is impedance matching at the diaphragm, resulting in acoustic absorption.

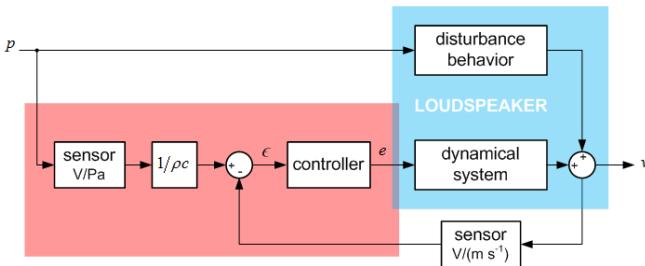

Figure 3: Block diagram of a loudspeaker considered as a dynamical system under control. The controlled variable v is the diaphragm normal velocity, the driving sound pressure p is considered as a disturbance, ϵ is the control error and the manipulated variable e is the applied voltage.

From a control perspective, the condition for acoustic impedance matching can be reformulated as an error signal $\epsilon(t)$ to be minimized by a controller, and written as

$$\epsilon(t) = \frac{p(t)}{\rho c} - v(t) \quad (7)$$

where $p(t)/\rho c$ is a time-varying reference (set point), and $v(t)$ is the measured process output, as depicted in Fig. 3. Taking the Laplace transform of Eq. (7) and identifying with (Eq. 3) we deduce that the controller gains should be such that

$$\frac{\Gamma_v}{\Gamma_p} = \rho c \quad (8)$$

in view of achieving optimal sound absorption.

2.3 Acoustic absorption capability

A closed form expression for the specific acoustic admittance at the transducer diaphragm can always be derived after Eqs. (1-2) regardless of the voltage applied across its electrical terminals [5]. Normalizing relative to the characteristic impedance of the medium ρc , the specific acoustic admittance ratio can be expressed as

$$y(s) = \rho c \frac{V(s)}{P(s)} \quad (9)$$

This dimensionless parameter reflects the motion (response) of the diaphragm that is caused by acoustic pressure. By combining Eqs. (1) and Eq. (3), the generalized velocity response of the transducer diaphragm to any surrounding sound field can be expressed as

$$y(s) = \rho c S \frac{Z_e(s) + Bl \Gamma_p}{Z_m(s) Z_e(s) + (Bl)^2 + Bl \Gamma_v} \quad (10)$$

where $Z_e(s) = R_e + sL_e$ is the blocked electrical impedance and $Z_m(s) = sM_{ms} + R_{ms} + 1/(sC_{mc})$ is the mechanical impedance. The corresponding reflection coefficient under normal incidence can be derived after

$$r(s) = \frac{1 - y(s)}{1 + y(s)} \quad (11)$$

and the extraction of the magnitude $|r(\omega)|$ of $r(s)$, where $s = j\omega$, yields the sound absorption coefficient $\alpha(\omega)$

$$\alpha(\omega) = 1 - |r(\omega)|^2 \quad (12)$$

which defines the ratio of the acoustic power absorbed by the transducer diaphragm relative to the incident sound power.

2.4 System stability

In order to anticipate stability issues, the Routh criterion is applied to the denominator of Eq. (10). The necessary condition for stability is that all poles have negative real parts. After developing Eq. (10), it comes

$$\Gamma_v > -\frac{R_{ms} L_e}{Bl C_{mc}} \left(\frac{L_e}{M_{ms} R_e + R_{ms} L_e} + R_e \right) - Bl \quad (13)$$

3 Control design

This section discusses active techniques for modifying the acoustic impedance at the loudspeaker diaphragm. The main goal is to control the diaphragm velocity response in order to adapt the acoustic impedance of the loudspeaker to the characteristic impedance of air. To that purpose the system is supposed to behave as a positive real system, i.e. with ability to dissipate acoustic energy. From a control design perspective, the general objective is to specify control settings that

1. meet the desired control bandwidth over which the transducer diaphragm is supposed to have prescribed behavior,
2. ensure that the diaphragm velocity follows the time-varying reference as accurately and as fast as possible,
3. make the closed loop as insensitive as possible relative to change in the transducer parameters,
4. guarantee the stability of the closed-loop system.

Generally speaking, strict adherence to all requirements over the entire audio-frequency range is limited by the technological design of the transducer. In the following, the general structure of feedback control applied to a loudspeaker is introduced by focusing the discussion on the intake of control theory for developing an active electroacoustic resonator.

3.1 Applying proportional gains

By applying feedback gains on acoustic variables, some unexpected behavior in the diaphragm velocity response may arise in the frequency range of interest [3, 5]. For instance, an over-reflective behavior can be observed when the gain Γ_p exceeds a certain bound (see Fig. 6, case D). To be consistent with a real positive system, the phase shift between the driving sound pressure and the diaphragm velocity response must alternate between $\pm \pi/2$. Otherwise, the diaphragm will reflect more acoustic energy than it received. In order to correct such undesired behavior, or to provide greater versatility, we shall now consider complementary ways to control the loudspeaker dynamics.

3.2 Introducing the lead-lag compensators

A lead-lag compensator is a component in a control system that improves an undesirable frequency response. It is commonly used to meet specifications on the steady-state accuracy and phase margin, or to improve the gain crossover frequency and closed-loop bandwidth [6]. In the context of acoustic impedance matching, the primary function of a lead compensator is to provide to the uncompensated loudspeaker a sufficient phase-lead so as to offset the excessive phase shift caused by proportional gains. The general architecture of a loudspeaker under feedback control and phase compensation is depicted in Fig. 4. Sensor sensitivity is suppressed for the sake of understanding. The specific structure of the phase-lead compensator is given by

$$C_{\text{lead}}(s) = K_1 \alpha \frac{\tau_1 s + 1}{\alpha \tau_1 s + 1} \quad \text{and} \quad 0 < \alpha < 1 \quad (14)$$

where K_1 is a gain, τ_1 is a time constant and α is an adjustment factor.

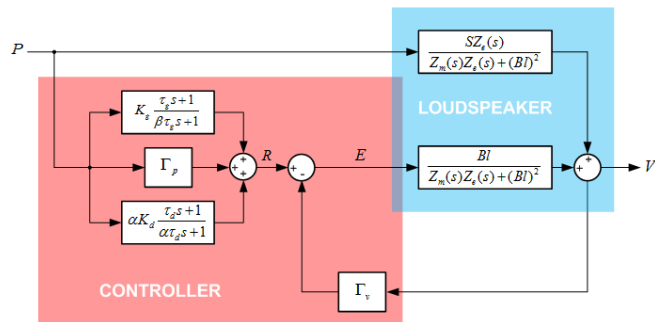

Figure 4: Block diagram of a loudspeaker under direct control of acoustic impedance and phase compensation.

The role of the lag compensator is to provide attenuation in the high-frequency range to allow sufficient phase margin to the system. The specific structure of the phase-lag compensator is given by

$$C_{\text{lag}}(s) = K_2 \frac{\tau_2 s + 1}{\beta \tau_2 s + 1} \quad \text{with} \quad \beta \geq 1 \quad (15)$$

where K_2 is a gain, τ_2 is a time constant and β is an adjustment factor.

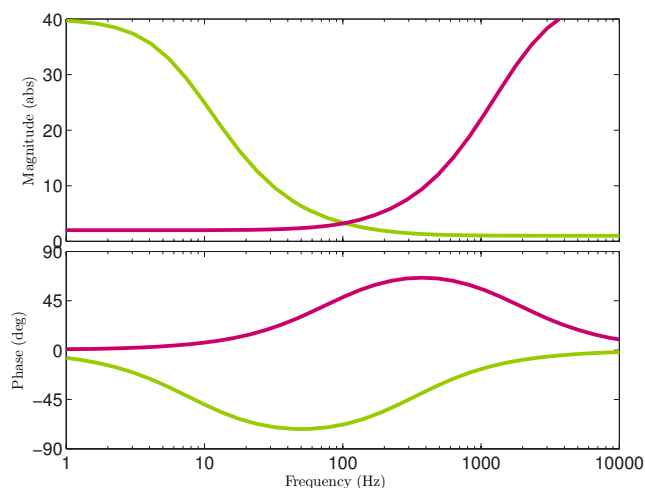

Figure 5: Magnitude and phase plot for typical lead (pink) and lag (green) compensators.

Table 1: Small signal parameters of the Monacor SPH-300TC.

Parameter	Notation	Value	Unit
dc resistance	R_e	6.3	Ω
Voice coil inductance	L_e	1	mH
Force factor	Bl	10.3	N A^{-1}
Moving mass	M_{ms}	68	g
Mechanical resistance	R_{ms}	3.24	$\text{N m}^{-1} \text{s}$
Mechanical compliance	C_{ms}	0.85	mm N^{-1}
Effective area	S	495	cm^2
Natural frequency	f_0	24	Hz

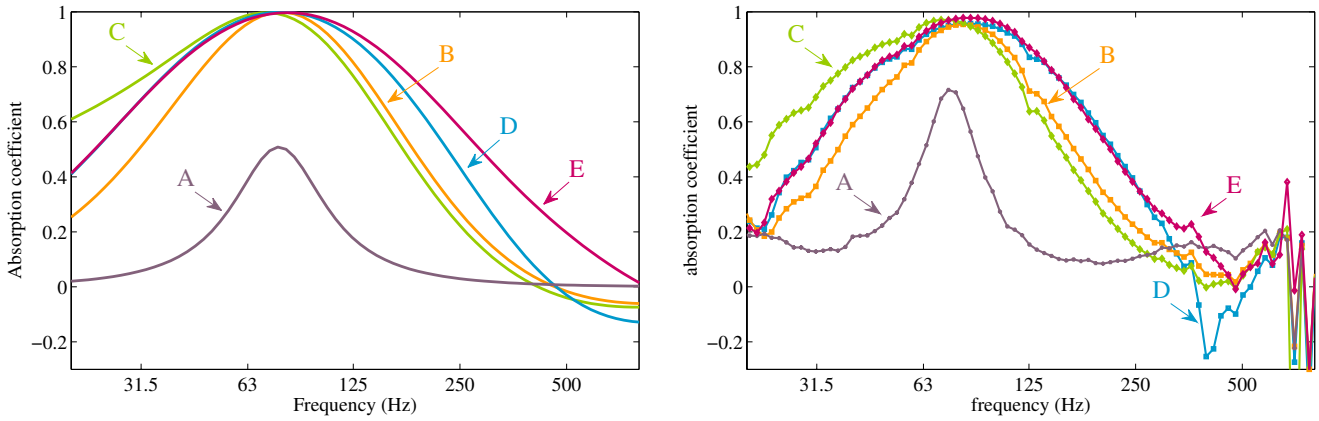

Figure 6: Absorption coefficient for various control settings. Computed results are shown at the top, and measured data are shown at the bottom.

Table 2: Control settings used for simulation and experimental evaluation.

Topology	Case	Feedback gains		Phase lead parameters			Phase lag parameters		
		Γ_p [V Pa ⁻¹]	Γ_v [V m ⁻¹ s]	K_1 [V Pa ⁻¹]	α	τ [s]	K_2 [V Pa ⁻¹]	β	τ_2 [s]
No control	A	-	-	-	-	-	-	-	-
Proportional gains only	B	0.024	10	-	-	-	-	-	-
With lag compensator	C	0.024	10	-	-	-	0.024	40	0.0005
Proportional gains only	D	0.048	20	-	-	-	-	-	-
With lead compensator	E	0.048	20	0.048	0.08	0.005	-	-	-

4 Results and discussion

4.1 Experimental setup

The experimental assessment of acoustic performances under normal plane wave incidence is processed after ISO 10534-2 standard [7], as depicted in Fig. 7. Three holes located at positions $x_1 = 0.8$ m, $x_2 = 0.46$ m and $x_3 = 0.35$ m from the electroacoustic resonator are the receptacles of 1/2" microphones (Norsonic Type 1225 cartridges mounted on Norsonic Type 1201 amplifier), sensing sound pressure $p_1 = p(x_1)$, $p_2 = p(x_2)$ and $p_3 = p(x_3)$. The transfer function $H_{12} = p_2/p_1$ and $H_{13} = p_3/p_1$ are processed through a Pulse Bruel and Kjaer multichannel analyzer. The motional feedback is processed through a Polytec OFV-505/5000 laser velocimeter (sensitivity of $\sigma_v = 50$ V m⁻¹ s. The sound pressure is sensed with an external PCB 130D20 microphone (sensitivity of $\sigma_p = 47.5$ mV Pa⁻¹), located at 5 mm of the diaphragm and slightly off-center at a height of 3.2 cm from the duct wall. The control system is implemented on a digital field programmable gate array (FPGA) CompactRIO platform.

4.2 Performance assessment

Applying a feedback control of acoustic quantities is a straightforward way to achieve a target acoustic impedance value over a desired bandwidth. As shown in Fig. 6, measured data confirm that the condition for creating optimal sound absorption is to achieve a constant ratio $\Gamma_v/\Gamma_p = \rho c$ for the feedback gains (cases B and D). The larger the gains while maintaining a constant ratio and the larger the control bandwidth. However, an over-reflective behavior of the loud-

speaker diaphragm occurs when the gain Γ_p exceeds a certain bound (see case D). It causes the electroacoustic resonator to respond as a positive real system, i.e. the real part of the specific acoustic impedance is positive while the phase between driving pressure and diaphragm velocity response alternate between $\pm \pi/2$. By varying the phase lead-lag control parameters the transducer behavior can be changed significantly. Introducing a phase lead compensator helps to get rid of the over-reflective behavior of the loudspeaker diaphragm in the frequency range of interest (case E). Adding a phase lag compensator increases the control bandwidth in the low frequency domain (case C). As clearly shown in Fig. 8, stability margins of the closed-loop system can be significantly improved when using a phase compensator in the control system.

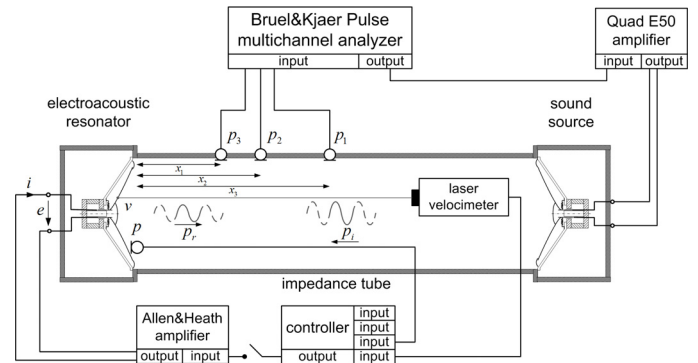

Figure 7: Schematics of the experimental setup.

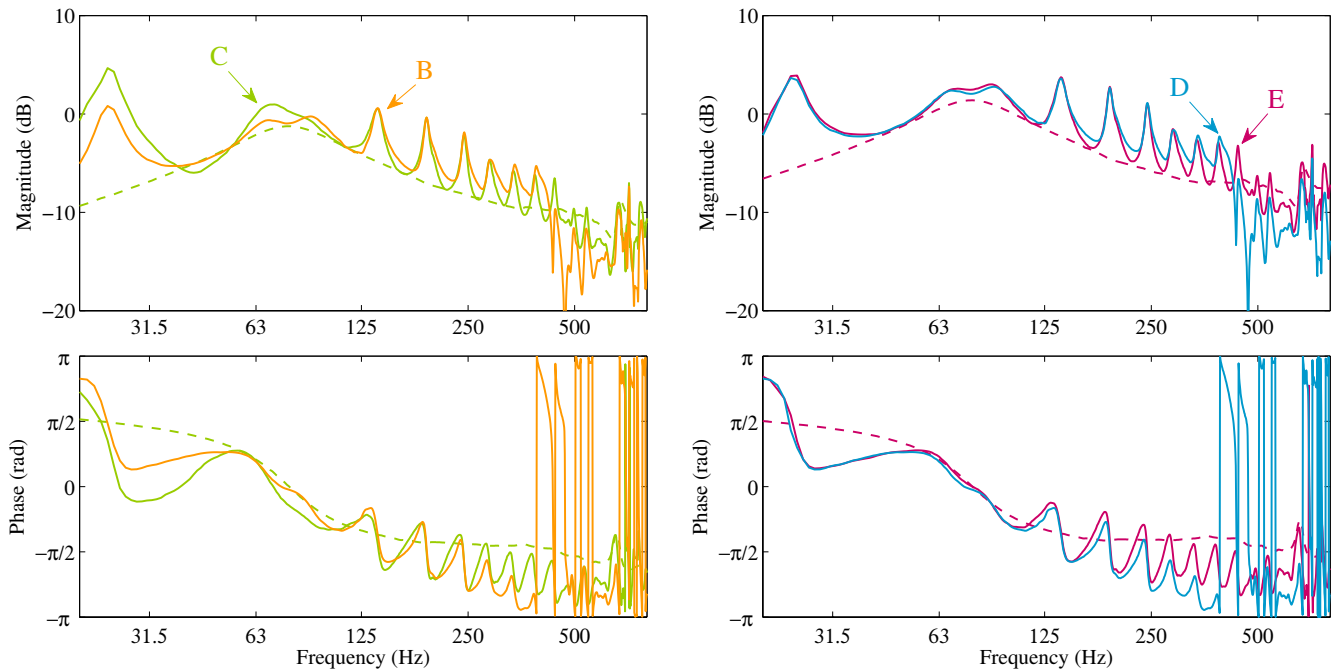

Figure 8: Open-loop gain measured with proportional control only (cases B and D) and when adding a phase lag (case C) and phase lead (case D) compensator. Data measured in impedance tube are shown in plain line and data measured in free field (anechoic room) are shown in dashed line.

5 Conclusion

Active control of a loudspeaker is addressed in this paper via an active electrical source connected at the terminals. By sending back a control voltage proportional to the sensed acoustic variables, the diaphragm acoustic impedance can be matched to the characteristic impedance of air, i.e. $Z_c = \rho c$. It results an optimal sound absorption, specifically in the low-frequency range where the usual passive soundproofing means are ineffective or their embodiment would become almost impractical. The classical control approach has been used to implement control strategies and specify the system performances in terms of control bandwidth and system stability. More elaborate controllers including lead-lag compensators are also introduced with a view of further improving control bandwidth, stability margins and versatility. Computed results are confirmed with data measured in impedance tube under normal plane wave incidence. Routh's criterion and open-loop gain measurements have been discussed in order to anticipate stability issues. Although it is not possible to draw general conclusions, these tools provide some working guidelines in order to implement tunable electroacoustic resonators in actual situations properly.

6 Acknowledgments

This work was supported by the Swiss National Science Foundation under Research Grant No. 200021-116977 and 200020-132869.

References

- [1] H. Kuttruff, *Room acoustics*, Spon Press, 5th edition, (2009).
- [2] T. J. Cox, P. D'Antonio, *Acoustic absorbers and diffusers: Theory, design and application*, Taylor and Francis, 2nd edition, (2009).
- [3] R. Boulandet, *Tunable electroacoustic resonators through active impedance control of loudspeakers*, PhD Thesis, École Polytechnique Fédérale de Lausanne, (2012).
- [4] M. Rossi, *Audio*, Presses Polytechniques et Universitaires Romandes, (2007).
- [5] H. Lissek, R. Boulandet, R. Fleury, *Electroacoustic absorbers: bridging the gap between shunt loudspeakers and active sound absorption*, *J. Acoust. Soc. Am.*, **129**(5), (2011).
- [6] K. Ogata, *Modern Control Engineering*, Prentice Hall Inc., 3rd edition, (1997).
- [7] ISO 10534-2: Acoustics - Determination of sound absorption coefficient and impedance in impedance tubes - Part 2: Transfer-function method, *International Standard Organisation*, (1998).