



HAL
open science

Efficiency of an acoustic table screen between two work stations in open plan offices

Isabelle Schmich, Christophe Rougier, Philippe Jean, Patrick Chevret

► **To cite this version:**

Isabelle Schmich, Christophe Rougier, Philippe Jean, Patrick Chevret. Efficiency of an acoustic table screen between two work stations in open plan offices. Acoustics 2012, Apr 2012, Nantes, France. hal-00810595

HAL Id: hal-00810595

<https://hal.science/hal-00810595>

Submitted on 23 Apr 2012

HAL is a multi-disciplinary open access archive for the deposit and dissemination of scientific research documents, whether they are published or not. The documents may come from teaching and research institutions in France or abroad, or from public or private research centers.

L'archive ouverte pluridisciplinaire **HAL**, est destinée au dépôt et à la diffusion de documents scientifiques de niveau recherche, publiés ou non, émanant des établissements d'enseignement et de recherche français ou étrangers, des laboratoires publics ou privés.



ACOUSTICS 2012

Efficiency of an acoustic table screen between two work stations in open plan offices

I. Schmich^a, C. Rougier^a, P. Jean^a and P. Chevret^b

^aCentre Scientifique et Technique du Bâtiment, 24 rue Joseph Fourier 38400 Saint Martin d'Hères

^bINRS, Rue du Morvan, CS 60027, 54519 Vandœuvre Les Nancy, France
isabelle.schmich@cstb.fr

Several solutions have been proposed to improve the acoustic comfort of users in open plan offices. One of them consists in the installation of a small absorbing screen between two face to face work stations. The height of this table screen is variable. Nowadays, it is difficult to accurately predict the efficiency of this kind of installation. A typical case of an office work station has been modelled and different heights of the table screen have been investigated through simulation. Two simulation methods have been compared: The first one (ICARE software developed at CSTB) uses asymptotic methods and is based on beam tracing including edge diffraction. The second method (MICADO 3D software developed at CSTB) uses the resolution through the Boundary Element Method where the Green function is optimized by the use of a source image technique. The simulation results show the insertion loss for the table screen and allows the determination of the most efficient height for the protection between two work stations. Finally, the simulation results are compared to measurements done in a semi-anechoic room by INRS.

1 Introduction

Workers in open plan offices often complain about the noise. The noise of the closest seated person is the most intrusive, for example if making a telephone call. A very common attempt to solve this consists of introducing a sound absorbing partition between two face to face work stations.

The purpose of this study is to evaluate the acoustical efficiency of screens of varying heights placed between two working desks facing each other in an open plan office. Due to the dimension of the open plan office room, the scene can be reduced to a double baffle problem (floor plus ceiling) including the desks.

2 Studied configurations

A double office desk (looking like a ping-pong table where the net is replaced by a plane screen of varying height) has been considered (see Figure 1).

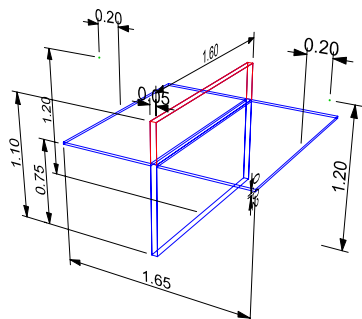

Figure 1: perspective view of the studied office desk.

The height of the absorbing screen between the source and receiver has been varied in steps of 10 cm from no screen (0.77 m) to a total height of 1.60 m.

For the simulation studies one source position at a height of 1.20 m and the mean value of a sphere made of 6 receivers (the size of a head) at 1.20 m to reduce modal effects have been used.

4 different cases have been studied:

- Case 1: Reflective floor without ceiling
- Case 2: Carpeted floor with a reflecting ceiling (plasterboard) at 2.70 m
- Case 3: Carpeted floor with an absorbing ceiling at 2.70 m (Eurocoustic Tonga 40 mm)
- Case 4: Carpeted floor with an absorbing ceiling at 2.70 m (Ecophon Master A 40 mm)

3 Simulations

Simulations have been carried out with three different calculation methods. For all calculations the geometric model is identical. As will be seen later, each calculation method uses its own input format for the absorption coefficients. Therefore, some observed differences might be due to the absorption coefficient conversions.

3D BEM calculations

3D BEM computation has the advantage of being very accurate. On the other hand, as the calculation time increases to the power 6 of the frequency, it is very difficult to achieve high frequencies. In this study, 20 frequencies per third octave band have been used for a frequency range of 50 to 3000 Hz.

The calculations of the acoustical insulation of the partitions placed between office desks have been done with the MICADO3D software developed by CSTB [1]. Since the desks are placed in an open office, therefore of large dimensions, it can be assumed that the floor and the ceiling are of infinite extent. Prior to this study, MICADO3D could only consider infinite rigid baffles or symmetry axes along x and/or y and/or z and only one per axis. Thus, it was impossible to model the floor and ceiling as two parallel baffles.

Therefore, the first simulations included a room modelled as a box having very absorbent vertical walls (normal absorption of 99.9 %). The floor and ceilings are of finite extent. The size of the room significantly influences the calculation time. It is easily understood that it would be very advantageous to reduce the model to only the desks.

The case of a domain bounded by two parallel baffles (herein called a strip) was, prior to this study, only programmed for the special case of a layer ground where the vibrating surface was in the plane of the top baffle [2]. For this study, the source image technique used to model the case of a vibrating tyre lying on the top surface of an asphalt strip has been generalized. The use of a Green function computed by means of the image source technique allows an important reduction of computation time. In addition, it must be noted that the y symmetry of the problem has been used.

The source image model uses the plane wave reflection coefficient based on the knowledge of the normal impedance. The proposed model has been fully validated by comparison with the former approach consisting in a room with an absorbent wall (see Figure 2).

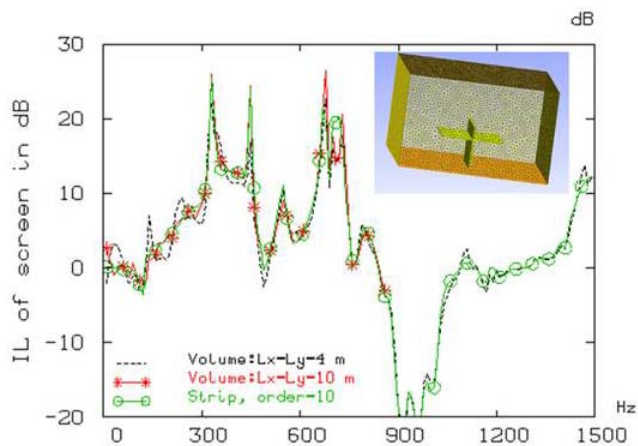

Figure 2: Validation of the strip method with MICADO3D for a screen of 1.10 m in height.

ICARE calculations

ICARE is beam-tracing software giving FRFs (Frequency Response Function) taking into account phase and interferences. It gives sound pressure level predictions, even with diffraction [3]. In this study, beams are shot from a point source to each of the 6 receivers (see Figure 3). Preliminary calculations of the desk have shown that in comparison with MICADO3D results taken as a reference it is better to take into account Capolino and Albani scattering coefficients [4] along with double edge scattering rather than simple edge diffraction with UTD coefficients (see Figure 5). For these calculations, a source with flat spectrum has been used. The screen is then modelled in ICARE by double edge diffraction in the following (see Figure 4). Convergence tests on sound pressure level lead us to choose a reflection order of 5 and a maximum of 2 diffracted contributions.

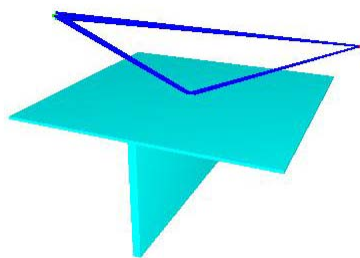

Figure 3: View of the rays between the source and the different receivers on the desk without partition.

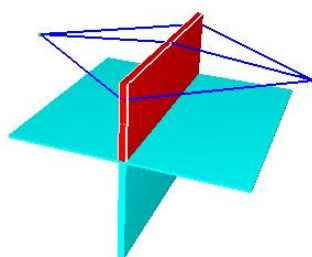

Figure 4: View of the paths between the source and the different receivers on the desk with screen

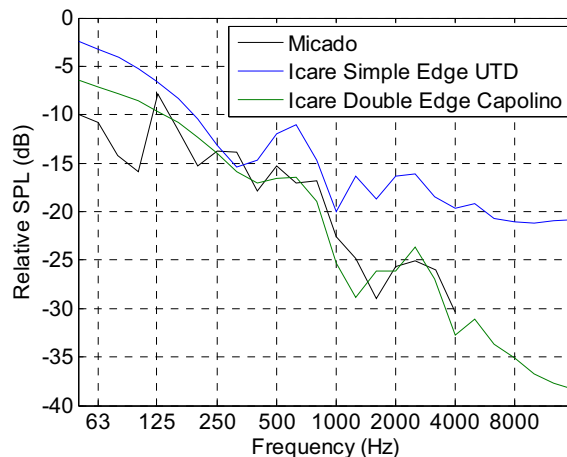

Figure 5: Simple edge UTD diffraction compared with double edge Capolino & Albani diffraction.

The ICARE software can handle diffuse absorption coefficients as well as complex impedances Z_n . The following section describes the absorption coefficients chosen and the relationships between absorption coefficients used for calculations and measurements. All ICARE computations have been made using the complex impedance Z_n .

RAYPLUS calculations

RAYPLUS is ray-tracing software developed at INRS for prediction in workshops [5]. It can handle all the main acoustic phenomena such as specular reflection off the walls and off the interior elements (screens, volumes), atmospheric absorption, absorption by the walls and by the elements inside the room and edge diffraction. Basically, the model is based on an energetic description of the sound field which does not take in account the phase differences between the paths at the receiver. Despite this restriction, it is possible to accommodate complex situations, a priori without any limitation on the dimensions, shape, or layout of the rooms.

4 Absorption coefficients

To be as close as possible to reality, different types of materials have been used. The floor is either rigid or carpeted. The desk is assimilated to be made of 20 mm thick particle board. The screen in the middle of the desk is assumed to be absorptive except for the measurements where it is made of the same material as the desk. The ceiling is either reflective, absorptive as a Eurocoustic Tonga 40 mm, or absorptive as an Ecophon Master A 40 mm. All normal absorption coefficients (α_n) used are given in Figure 6. The normal impedances used have been calculated from α_n .

Generally, the floor (carpet) and the ceiling (absorbing panels) are characterised by diffuse absorption coefficients α_d . A first problem arises from the fact that the 3D-BEM approach describes surfaces by a normalized impedance Z_n , which is easily related to an absorption coefficient for normal incidence α_n , see Eq. (1).

$$Z_n = \frac{1 + R_n}{1 - R_n}, \text{ with } R_n = \sqrt{1 - \alpha_n} \quad (1)$$

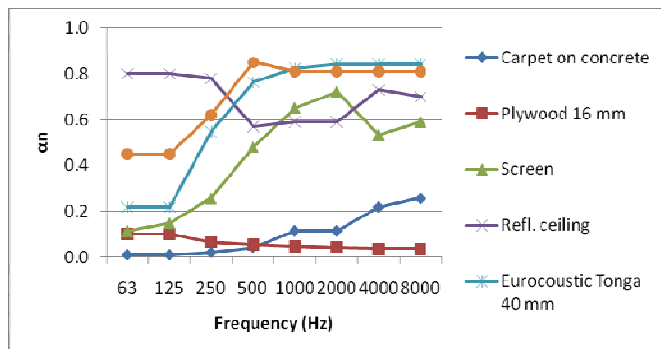

Figure 6: Normal incidence α_n coefficients used in BEM3D.

Relating α_d and α_n is, however, a tricky problem. The approximate formula given by Morse and Ingard [6] gives the relation between Z_n and α_d which gives good results for rather hard surfaces [2] even when only keeping the first term, see Eq. (2). In our case, it appears that computation results with ICARE using Z_n calculated from Eq. (2) fit well with those using α_d even with absorptive surfaces in the model (ceiling, screen). The relation between α_d and α_n is then found by putting Eq. (2) into Eq. (1).

$$Z_n = 8/\alpha_d \quad (2)$$

5 Real-scale model measurement

At INRS a real scale model has been constructed and measured in a semi-anechoic chamber which has been equipped with a removable aluminium structure. This structure is suspended above the floor by means of a hoist enabling its height to be adjusted. The structure is made up of a grid of tensioned cables for supporting boards that are easy to put in place as the tests require. Absorbent structures can also be suspended from the cables so as to represent conditions close to a real environment (e.g. when a plenum space is present). In this paper, a reflective structure was chosen, with plaster boards being installed on the grid of cables. 6 boards having a thickness of 13 mm were juxtaposed to form a total area of 18 m² (3.6 m x 5 m) above the desk. The reflection coefficient was measured in situ. An illustration of the installation is shown on Figure 7.



Figure 7: View of the measurement set-up with a reflective ceiling and a screen height of 1.10 m

For case 2, no carpet has been used in the measurement set-up. A rigid floor was used instead.

Sound source

For the tests, a source with a compression chamber was set up. The main purpose of the source was to generate an omnidirectional field, at a point and of level sufficiently high relative to the background noise in the frequency band delimited by the octave bands 125 Hz and 8000 Hz. The compression chamber was extended by a flexible PVC pipe having a diameter of 3 cm and a thickness of 4 mm. An image of the source is presented in Figure 8.



Figure 8: View of the sound source used for the real-scale measurements

6 Results

The results are shown in terms of insertion loss in third octave bands of the screen compared to the case without screen.

Case 1: Reflective floor without ceiling

Figure 9 shows the results for the Sound Pressure Level of case 1 with and without partition for a screen with a height of 1.60 m without ceiling. As the SPL for the calculations of the office desk without screen always shows a strong negative peak, it can be deduced that it is due to the interference of a “ground effect”. As it will be seen later, this negative peak around 1000 Hz is found again for the insertion loss.

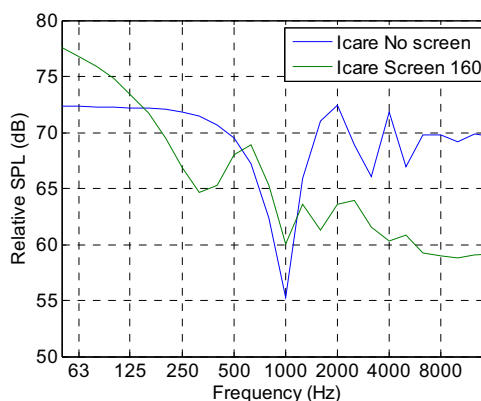

Figure 9: Relative SPL for case 1 without ceiling

Figure 10 shows the results for case 1 for a reflective floor without ceiling in third octave bands. The frequency evolution of the insertion loss for all heights is very similar between the measurements and the simulations done with ICARE and MICADO3D. As expected for asymptotic methods, the simulations with ICARE are less accurate in low frequencies. This is especially the case when the partition between the work stations is low.

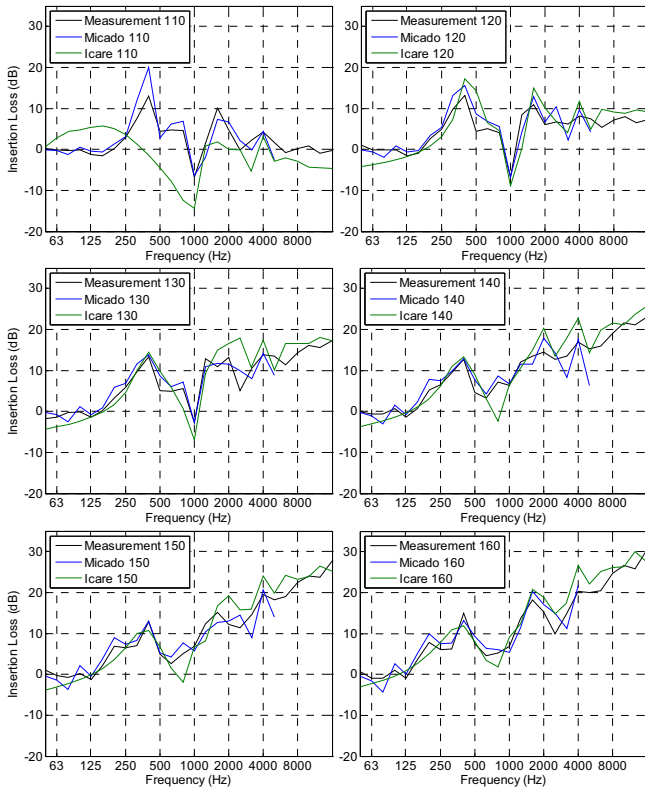

Figure 10: Case 1 - Insertion loss in third octave bands for different heights of the screen: ICARE, MICADO3D and Measurements.

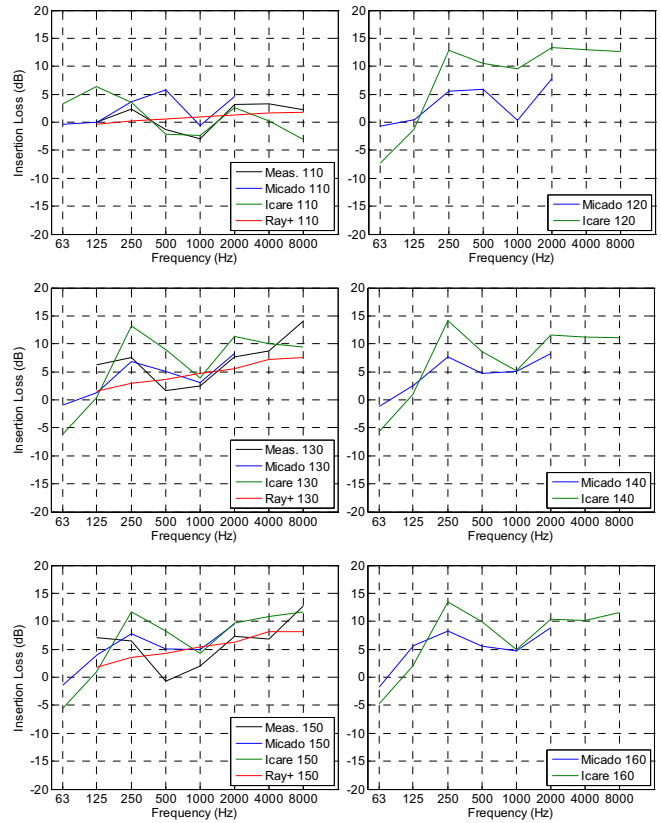

Figure 11: Case 2 - Insertion loss in octave bands for different heights of the screen: ICARE, MICADO3D and Measurements.

Case 2: Carpeted floor with a reflecting ceiling

Figure 11 shows the results for case 2 for an absorbing carpeted floor with a reflective ceiling (plaster board) in octave bands. The general frequency evolution of the insertion loss for the different simulation methods and the measurements are similar above 1000 Hz. The interferences are mostly located at the same frequencies. It has to be noted that because RAYPLUS is based on an energetic calculation the results can only show the tendency and not the interferences. In low frequencies the MICADO3D gives good results with an exception for the 500 Hz octave band. This might be due to an inaccurate absorption coefficient at this frequency band. In general, the differences of the curves could be explained by the fact that the differences in the absorption coefficients used in the simulations and measurements have a non negligible effect.

Case 3: Carpeted floor with an absorbing ceiling I

Figure 12 shows the simulation results with ICARE and MICADO3D for case 3 for an absorbing carpeted floor with an absorbing ceiling (Eurocoustic Tonga 40 mm) in third octave bands. Except for the screen height of 1.10 m, the frequency evolution of the insertion loss is quite similar, even if ICARE seems to overestimate the different interference peaks which is characteristic for asymptotic methods.

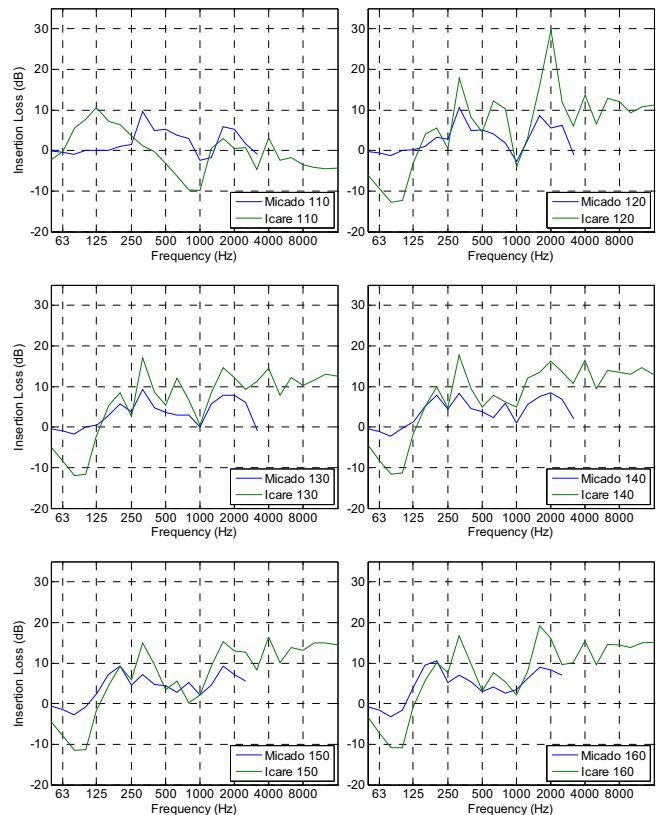

Figure 12: Case 3 - Insertion loss in third octave bands for different heights of the screen: ICARE and MICADO3D.

Case 4: Carpeted floor with an absorbing ceiling II

Figure 13 shows the simulation results for case 3 for an absorbing carpeted floor with an absorbing ceiling (Ecophon Master A 40 mm) in third octave bands. Again the insertion loss of both methods has a similar frequency evolution for a screen height above 1.20 m. ICARE seems to overestimate the peaks. It can be seen that increasing screen heights from 1.30 m on seem not to change the results of the insertion loss.

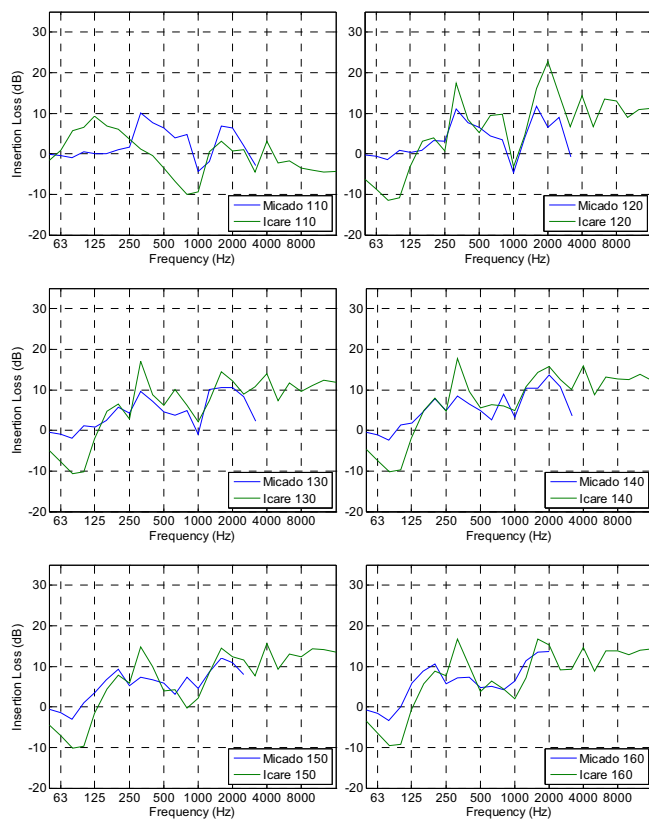

Figure 13: Case 4 - Insertion loss in third octave bands for different heights of the screen: ICARE and MICADO3D.

5 Conclusion

Different cases of an office desk in an open plan office have been studied. The insertion loss due to a partition between two work stations has been evaluated.

Simulations have been done with different methods: 3D BEM, beam-tracing and ray-tracing with an energetic approach.

In order to accelerate the 3D BEM calculations the double baffle problem has been successfully introduced into the MICADO3D software.

Different diffraction methods are implemented in ICARE and have been compared. It seems that the Capolino method with a thick screen providing double edge diffraction gives the best results.

For the case without ceiling the comparison of ICARE, MICADO3D and the measurements give very good results. Differences occur for the case with a reflective ceiling. These differences might be due to the problem of using the right absorption coefficients in the simulation models. Nevertheless, the general frequency evolution of the insertion loss is given for all used simulation methods. In

the case of absorptive ceilings, MICADO3D and ICARE give the same positions of the interferences. ICARE seems to overestimate the different interference peaks which is characteristic for asymptotic methods.

From this study, the optimum screen height seems to be at 1.30 m as the insertion loss between work stations does not improve by using higher partitions.

Still, more work needs to be done to be able to conclude on the comparison between the different simulation methods. Especially, in order to improve the results, the used absorption coefficients should be as similar as possible between the different models. Special care will be given to the measurement of the absorption coefficients to be used in the different simulation models.

In the future, real-scale measurements of the Ecophon Master A 40 mm absorptive ceiling are planned.

Acknowledgments

The authors like to thank the active members of the AFNOR standardisation group S30D who initiated this study by their curiosity and technical questions.

References

- [1] P. Jean, "A multi domain BEM approach. Application to outdoor sound propagation and tyre noise." *Procc. Euronoise*, Tampere, Finland (2006).
- [2] P. Jean, J. F. Rondeau, A Simple Decoupled Modal Calculation of Sound Transmission Between Volumes, *Acta Acustica united with Acustica*, Vol. 88: 924 – 933, (2002)
- [3] M. Vermet at al., "Using asymptotic methods to compute diffracted pressure by curved surfaces", *Procc. ICTCA conference*, Dresden, Germany (2009).
- [4] N. Noe, M. Vermet, "Application de l'acoustique géométrique à la simulation de la réflexion et de la diffraction par des surfaces courbes", *Procc. of 10ème Congrès Français d'Acoustique*, Lyon, France (2010).
- [5] Ondet, A. M. and Barbry, J. L "Modeling of sound propagation in fitted workshop using ray tracing," *J. Acoust. Soc. Am.*, 85(2): 787-796, (1989).
- [6] P. M. Morse, K. U. Ingard: *Theoretical acoustics*. p.580. Mc Graw-Hill, New-York (1968).