



HAL
open science

Fault Diagnosis Based on Fuzzy Observers for Wind Energy Conversion Systems

Elkhatib Kamal, Abdel Aitouche, Mireille Bayart

► **To cite this version:**

Elkhatib Kamal, Abdel Aitouche, Mireille Bayart. Fault Diagnosis Based on Fuzzy Observers for Wind Energy Conversion Systems. International Conference on Renewable Energy and Eco-Design in Electrical engineering:, Mar 2011, Lille, France. pp.1-8. hal-00804062

HAL Id: hal-00804062

<https://hal.science/hal-00804062>

Submitted on 24 Mar 2013

HAL is a multi-disciplinary open access archive for the deposit and dissemination of scientific research documents, whether they are published or not. The documents may come from teaching and research institutions in France or abroad, or from public or private research centers.

L'archive ouverte pluridisciplinaire **HAL**, est destinée au dépôt et à la diffusion de documents scientifiques de niveau recherche, publiés ou non, émanant des établissements d'enseignement et de recherche français ou étrangers, des laboratoires publics ou privés.

Fault Diagnosis Based on Fuzzy Observers for Wind Energy Conversion Systems

Elkhatib KAMAL†, Abdel AITOUICHE†† and Mireille BAYART†

LAGIS FRE CNRS 3033,
Lille University Nord, France

†Polytech-Lille, Rue Paul Langevin, 59655, Villeneuve d'Ascq, France

Tel: +33(0)320 434 650 – Fax: +33(0)320 337 189– e-mail: elkhatib.ibrahim@polytech-lille.fr

††HEI, 13 rue de Toul, 59046, Lille Cedex, France

Tel: +33(0)328 384 822 – Fax: +33(0)328 384 804 email: abdel.aitouche@hei.fr

Abstract

This paper addresses the design of fault diagnosis for Wind Energy Conversion System (WECS). In this approach, the residual signal is generated by a fuzzy observer which is based on Takagi-Sugeno (TS) fuzzy models based on Lyapunov function. The approach presented takes into account the stability and design of non-linear fuzzy inference systems based also on TS fuzzy models. The paper derives the necessary conditions for the assignability of eigenvalues to a region in the s -plane and the necessary conditions to guarantee the stability of fuzzy models. The problem is solved via the Linear Matrix Inequalities (LMI) method. The proposed TS observer is used for detection and isolation of faults which can affect a TS model. The proposed methodology is illustrated by estimating the speed of blades, speed of generator and the diagnosis fault of WECS.

1. Introduction

Wind power is a kind of renewable energy and plays an important role in the future energy supply. Without question, the safe operation of control system which is the center of wind turbine is essential to ensure the running of the unit. However, wind turbine usually works under the bad environment. The gearbox and bearing failure [1]-[3] and various sensor faults often occur, such as sensor bias fault, sensor constant gains and so on. Wind generators are also inaccessible since they are situated on extremely high towers, which are normally 20 m or greater in height. When fault occurs it will seriously affect the engineering quality and cause great economic losses. Consequently the use of advanced fault detection, isolation and accommodation methods could improve the reliability of the turbine, even though, for some faults, it might result in production with limited power. Alternatively condition monitoring is used to monitoring some mechanical components such as gear box etc,[4]. This allows for early detection of the degeneration of the generator health, facilitating a proactive response, minimizing downtime, and maximizing productivity [5]-[7]. Recently, the fault mode behavior, protection and fault tolerant control of WECS have been covered in a large number of papers [8]-[15]. Reference [8] an observer based scheme to detect sensor faults in the pitch system

was presented. A parity equations based scheme for fault detection on wind turbines was presented in [9]. An unknown input observer was proposed for detection of sensor faults around the wind turbine drive train in [10]. Fault detection of electrical conversion systems can be found e.g. in [11]. References [12]-[15] present fault diagnosis of wind turbine control system based on artificial neural network. Also many current papers studied the fault tolerant control of electrical drive [16]-[18] or the fault detection and diagnosis of rotating machinery [19],[20]. Field programmable gate array (FPGA)-based real-time power converter failure diagnosis for fault tolerant WECS with electrical machine has never been presented in [21]. Reference [22] shows current Sensor fault-tolerant control for WECS with double feed back induction generator.

In this paper fuzzy logic is combined with the model-based method to formulate the so-called fuzzy observers. The main idea is to use the Takagi-Sugeno fuzzy model [18]. The idea of the TS model approach is to apprehend the global behaviour of a system by a set of local models, each of them characterizing the behaviour of the system in a particular zone of operation. The local models are then aggregated by means of an interpolation mechanism. So under the fuzzy logic observer scheme, a number of local linear observers are designed and the state estimation is given by a fuzzy fusion of local observer outputs. The diagnostic signal - a residual is the difference between the estimated and actual system outputs. Although all local observers are stable, the global observer is not necessary stable (i.e. the state estimation may not be converge). In this paper, the linear matrix inequality approach is used to analyze the global stability of the fuzzy observer and some measures to achieve global stability are presented.

The paper is organized as follows: In Section 2, the general structure of the Takagi-Sugeno fuzzy model and fuzzy controller are presented. The concept and structure of fuzzy observers and residual generation are presented in Section 3. Section 4 shows stability analysis for the proposed algorithm. Section 5 present System description and fault specifications. In section 6 the fuzzy observer for the described system is presented. Section 7

presents simulation of the wind turbine. Finally, concluding remarks are made in section 8 followed by the list of appendix and references.

2. Takagi-Sugeno Fuzzy PLANT Model and Nonlinear Controller

2.1. Takagi-Sugeno Fuzzy Plant Model

The TS fuzzy plant model describes the dynamic property of a nonlinear plant through fuzzy rules that have linear systems as the consequent parts. The inferred system is expressed as a weighted sum of a number of linear sub-systems [23]-[25]. Let r be the number of fuzzy rules describing the nonlinear plant. The i^{th} rule is of the following format,

Plant Rule i :

IF $f_1(x(t))$ is N_1^i AND ...AND $f_\psi(x(t))$ is N_ψ^i

$$\begin{aligned} \text{Then } \dot{x}(t) &= A_i x(t) + B_i u(t) \\ y(t) &= C_i x(t) \end{aligned} \quad (1)$$

Where $x(t) \in R^{nx1}$ is the state vector, $u(t) \in R^{mx1}$ is the input vector, $y(t) \in R^{gx1}$ is the output vector.

$A_i \in R^{nxn}$, $B_i \in R^{nxm}$, $C_i \in R^{gxn}$ and $D_i \in R^{gxm}$ are constant system matrices. $f_1(x(t))$, ..., $f_\psi(x(t))$

are the premise variables, N_α^i is a fuzzy term of rule i corresponding to the function $f_\alpha(x(t))$, $\alpha = 1, \dots, \psi$, $i = 1, 2, \dots, r$ and ψ is a positive integer. Given the input vector $u(t)$, the global state and output of the system are inferred as follows:

$$\dot{x}(t) = \sum_{i=1}^r \mu_i(f(t)) [A_i x(t) + B_i u(t)] \quad (2)$$

$$y(t) = \sum_{i=1}^r \mu_i(f(t)) C_i x(t) \quad (3)$$

where

$$\mu_i(f(t)) = \frac{h_i(x(t))}{\sum_{i=1}^r h_i(x(t))}, \quad h_i(x(t)) = \prod_{\alpha=1}^{\psi} N_\alpha^i(x(t))$$

$\mu_i(f(t))$ is the grade of membership of the premise variable $f(t)$, or the tensor product of grade of memberships, if $f(t)$ is a vector. The membership grade function $\mu_i(f(t))$ satisfies the following constraints

$$0 \leq \mu_i(f(t)) \leq 1, \quad \sum_{i=1}^r \mu_i(f(t)) = 1 \quad \forall i = 1, 2, \dots, r$$

2.2. Nonlinear Controller

In the Parallel Distributed Compensation (PDC) design [25], each control rule is designed from the corresponding rule of a TS fuzzy model. The designed fuzzy controller shares the same fuzzy sets with the fuzzy model in the premise parts. For the fuzzy model (1) we construct the following fuzzy controller via the PDC. It is supposed that the fuzzy system (1) is locally controllable. A state-feedback by linear matrix Inequalities (LMI) is used to design

controller for each subsystem.

Controller Rule j^{th} :

IF $g_1(x(t))$ is M_1^j AND ...AND $g_\Omega(x(t))$ is M_Ω^j

$$\text{Then } u(t) = -G_j x(t) \quad (4)$$

Where M_β^j is a fuzzy term of rule j corresponding to the function $g_\beta(x(t))$, $\beta = 1, \dots, \Omega$, $j = 1, 2, \dots, c$ and

Ω is a positive integer. $G_j \in R^{mxn}$ is feedback gains vectors of rule j and c is the number of rules. Then, the final output of the fuzzy controller is

$$u(t) = -\sum_{j=1}^c m_j(g(t)) G_j x(t) \quad (5)$$

where

$$0 \leq m_j(g(t)) \leq 1, \quad \sum_{i=1}^c m_j(g(t)) = 1 \quad \forall j = 1, 2, \dots, c \quad (6)$$

$$m_j(g(t)) = \frac{q_j(x(t))}{\sum_{j=1}^c q_j(x(t))}, \quad q_j(x(t)) = \prod_{\beta=1}^{\Omega} M_\beta^j(g(t)) \quad (7)$$

From Eq. (2), and Eq. (5), the fuzzy control system is given by:

$$\dot{x}(t) = \sum_{i=1}^r \sum_{j=1}^c \mu_i(f(t)) m_j(g(t)) (A_i - B_i G_j) x(t) \quad (8)$$

3. Fuzzy Observer Model and Residual Generation

3.1. TS Fuzzy Observers

This section presents fuzzy observer design methodologies involving state estimation for TS fuzzy models. In practice, all of states are not fully measurable, it is necessary to design a fuzzy observer in order to implement the fuzzy controller (5). For the fuzzy observer design, it is assumed that the fuzzy system model (1) is locally observable. As in all observer designs, fuzzy observers [26] are required to satisfy

$$x(t) - \hat{x}(t) \rightarrow 0 \quad \text{as } t \rightarrow \infty$$

Where $\hat{x}(t)$ is the estimated state vector by fuzzy observers. This condition guarantees that the steady-state error between $x(t)$ and $\hat{x}(t)$ converges to 0. As in the case of controller design, the PDC concept is employed to arrive at the following fuzzy observer structures:

Observer Rule i:

IF $f_1(x(t))$ is N_1^i AND ...AND $f_\psi(x(t))$ is N_ψ^i

$$\begin{aligned} \text{Then } \dot{\hat{x}}(t) &= A_i \hat{x}(t) + B_i u(t) + L_i (y(t) - \hat{y}(t)) \\ \hat{y}(t) &= C_i \hat{x}(t) \quad i=1, 2, \dots, r \end{aligned} \quad (9)$$

Where $L_i (1, 2, \dots, r)$ are observation error matrices. $y(t)$ and $\hat{y}(t)$ are the final output of the fuzzy system and the fuzzy observer respectively. The fuzzy observer has the linear state observer's laws in

its consequent parts. For design of augmented system, we present LMI-based designs for an augmented system containing both the fuzzy controller and observer. The dependence of the premise variables on the state variables makes it necessary to consider two cases for fuzzy observer design:

3.1.1. Case A

$f_1(x(t)), \dots, f_\psi(x(t))$ do not depend on the state variables estimated by a fuzzy observer. The overall state estimation is a non-linear combination of individual local observer outputs. Then the overall observer dynamic is given by

$$\dot{\hat{x}}(t) = \sum_{i=1}^r \mu_i(x(t)) [A_i \hat{x}(t) + B_i u(t) + L_i (y(t) - \hat{y}(t))] \quad (10)$$

$$\hat{y}(t) = \sum_{i=1}^r \mu_i(x(t)) C_i \hat{x}(t) \quad (11)$$

We use the same weight $h_i(x(t))$ defined in section 2.1 as that of the i^{th} rule of the fuzzy models. The structure of the fuzzy observer as shown in Fig.1.

According Eq.(4), Eq.(5) and estimated state we obtain the following fuzzy controller:

Controller Rule i:

IF $g_1(x(t))$ is M_1^j AND ...AND $g_\Omega(x(t))$ is M_Ω^j

$$\text{Then } u(t) = -G_j \hat{x}(t) \quad j=1, 2, \dots, c \quad (12)$$

Then, the inferred output of the fuzzy controller is given by:

$$u(t) = -\sum_{j=1}^c m_j(g(t)) G_j \hat{x}(t) \quad (13)$$

By respectively substituting (13) into (2) and (10), and let $e(t) = x(t) - \hat{x}(t)$ we obtain the following system representations:

$$\dot{x}(t) = \sum_{i=1}^r \sum_{j=1}^c \mu_i m_j ((A_i - B_i G_j) x(t) + B_i G_j e(t)) \quad (14)$$

$$\dot{e}(t) = \sum_{i=1}^r \sum_{j=1}^c \mu_i m_j (A_i - L_i C_j) e(t) \quad (15)$$

Therefore, the augmented systems are represented as follows:

$$\dot{x}_a(t) = \sum_{i=1}^r \sum_{j=1}^c \mu_i m_j K_{ij} x_a(t) \quad (16)$$

$$\text{where } x_a(t) = \begin{bmatrix} x(t) \\ e(t) \end{bmatrix}, K_{ij} = \begin{bmatrix} A_i - B_i G_j & B_i G_j \\ 0 & A_i - L_i C_j \end{bmatrix}$$

A sufficient condition that guarantees the stability of the fuzzy system is obtained in terms of Lyapunov's direct method. The augmented system described by Eq. (16) is globally asymptotically stable if there exists a common positive definite matrix P such that

$$K_{ii}^T P + P K_{ii} < 0 \quad (17)$$

$$\left(\frac{K_{ij} + K_{ji}}{2} \right)^T P + P \left(\frac{K_{ij} + K_{ji}}{2} \right) < 0 \quad \forall i, j \quad (18)$$

3.1.2. Case B

$f_1(x(t)), \dots, f_\psi(x(t))$ depend on the state variables estimated by a fuzzy observer. So we use $f(\hat{x}(t))$ instead of $f_1(x(t))$ because $\hat{x}(t) \neq x(t)$

The fuzzy observers for Case B are of the following forms, instead of Eq.(10).

$$\dot{\hat{x}}(t) = \sum_{i=1}^r \mu_i(\hat{x}(t)) [A_i \hat{x}(t) + B_i u(t) + L_i (y(t) - \hat{y}(t))] \quad (19)$$

$$\hat{y}(t) = \sum_{i=1}^r \mu_i(\hat{x}(t)) C_i \hat{x}(t) \quad (20)$$

Accordingly, instead of Eq.(13), the PDC fuzzy controller becomes

$$u(t) = -\sum_{j=1}^c m_j(\hat{g}(t)) G_j \hat{x}(t) \quad (21)$$

We use the same weight $h_i(x(t))$ as that of the i^{th} rule of the fuzzy models and the property of

$$\sum_{i=1}^r \mu_i = \sum_{j=1}^c m_j = \sum_{i=1}^r \sum_{j=1}^c \mu_i m_j$$

Then the augmented systems are obtained as follows:

$$\dot{x}_a(t) = \sum_{i=1}^r \sum_{j=1}^c \sum_{k=1}^c \mu_i (f(t)) m_j (\hat{g}(t)) m_k (\hat{g}(t)) K_{ijk} x_a(t) \quad (22)$$

$$\text{where } K_{ijk} = \begin{bmatrix} A_i - B_i G_k & B_i G_k \\ S_{ijk}^1 & S_{ijk}^2 \end{bmatrix}$$

$$S_{ijk}^1 = (A_i - A_j) - (B_i - B_j) G_k + L_j (C_k - C_i)$$

$$S_{ijk}^2 = (A_i - L_j C_k) - (B_i - B_j) G_k$$

also the augmented system described by Eq.(22) is globally asymptotically stable if there exists a common positive definite matrix P such that

$$K_{ijj}^T P + P K_{ijj} < 0 \quad (23)$$

$$\left(\frac{K_{ijk} + K_{ikj}}{2} \right)^T P + P \left(\frac{K_{ijk} + K_{ikj}}{2} \right) < 0 \quad \forall i, j, k$$

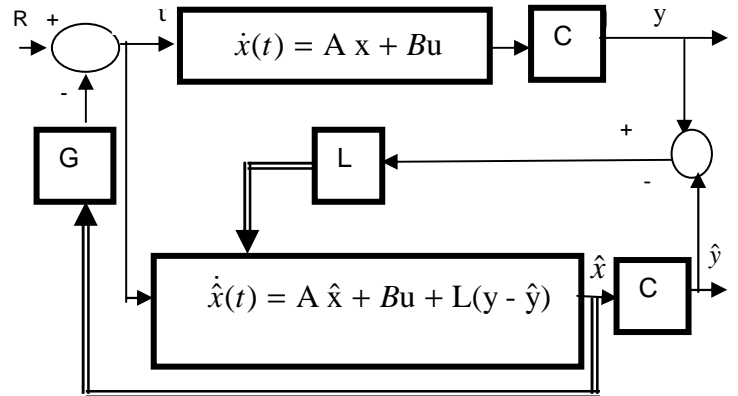

Figure 1: Fuzzy Observer Structure

3.2. Residual Generation

Once the state and/or output are estimated, the diagnostic signal residual, can be generated by the comparison of measured and estimated outputs.

$$\text{Residual: } r(t) = y(t) - \hat{y}(t) \quad (25)$$

$$\|r(t)\| \begin{cases} \leq Th & \text{Normal} \\ \geq Th & \text{Fault} \end{cases} \quad (26)$$

Where Th is the threshold value

4. Stability Analysis For The Proposed Algorithm

For the fuzzy control system of (16) the sufficient stability condition is summarized by the following *Lemma*: The fuzzy control system of (16) is guaranteed to be globally asymptotically stable if the gains of the nonlinear controller of (13) are chosen as,

$$\begin{cases} q_j(x(t) = x_a(t)^T \left(\sum_{i=1}^r \mu_i Q_{ij} - Q_m \right) x_a(t) & \text{when } x(t) \neq 0 \\ q_j(x(t) = \frac{1}{c} & \text{when } x_a(t) \neq 0 \quad \text{for } j = 1, 2, \dots, c \end{cases} \quad (27)$$

and there is a common solution of P for the following LMI,

$$\begin{cases} Q_m > 0 \\ \sum_{k=1}^c Q_{ik} - c Q_m > 0 & \text{for all } i = 1, 2, \dots, r \end{cases} \quad (28)$$

where

$$Q_m = -(K_m^T P + P K_m) \quad \text{for } i = 1, 2, \dots, r; \quad j = 1, 2, \dots, c,$$

$$Q_{ij} = -(K_{ij}^T P + P K_{ij})$$

$K_m \in R^{n \times n}$ is a stable matrix to be designed.

$Q_m \in R^{n \times n}$ is a symmetric positive definite matrix

and $Q_{ij} \in R^{n \times n}$ is a symmetric matrix.

Lemma governs the way of designing the gains of the nonlinear controller of (13). The number of linear matrix inequalities is reduced to $r+1$, instead of $r(r+1)/2$ as stated in [27].

5. System Description and Specification of Faults

5.1. System Description

WECS illustrated by Fig.2. This system comprises of wind turbine, a drive train and induction generator (IG). The IG turbine are the most important part of this system and hence its reliability should be guaranteed. The possible faults in this system include the generator speed sensor and rotational speed of the turbine. The residual signal generated by the observer in this system is used as alarm signal for fault diagnosis

The dynamics of the system can be characterized by the following equations [28]:

$$\dot{x}(t) = A(x)x(t) + Bu(t) + W_I, \quad y(t) = c x(t) \quad (29)$$

Where

$$A(x) = \begin{bmatrix} \frac{k(\omega_t \omega_t - f_T)}{J_T} & 0 & -\frac{1}{J_T} \\ 0 & \frac{f_G}{J_G} & \frac{1}{J_G} \\ d + \frac{k(k \omega_t - f_T)}{J_T} & \frac{k}{J_G} f_G & (\frac{k}{J_T} - \frac{k}{J_G}) \end{bmatrix}$$

$$u(t) = \begin{bmatrix} T_{G,ref} \end{bmatrix}, \quad B = \begin{bmatrix} 0 & -\frac{1}{J_G} & \frac{k}{J_G} \end{bmatrix}^T,$$

$$c = \begin{bmatrix} 1 & 0 & 0 \\ 0 & 1 & 0 \end{bmatrix} \quad \text{and } x(t) = \begin{bmatrix} \omega_t & \omega_G & T_G \end{bmatrix}^T$$

u is the input vector, V is the wind speed and x is state vector. w_I is the wind disturbance and is defined by

$$w_I^T = [\chi \cdot V \quad 0 \quad 0], \quad (30)$$

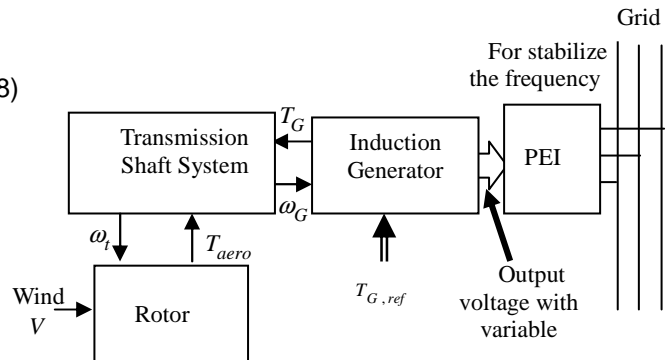

Figure 2: Structural diagram of wind power system

where, $\chi = 0.1$ represents the variance of random component of wind variation. ω_G is the rotational speed of the generator. J_T and J_G are the moments of inertia of the turbine and generator respectively. f_T and f_G are the friction coefficient of the shaft at the rotor and generator sides. d is the damping coefficient. k is the stiffness coefficient. T_G is the electromagnetic torque. $T_{G,ref}$ is the reference electromagnetic torque. The aerodynamic coefficient of the system are defined by

$$k_{\omega} = \frac{-1}{2} \rho \pi L^5 \frac{C_p}{\lambda^3}, \quad T_{aero} \text{ is aerodynamic torque}$$

Eq.(29) indicates that the terms A and B are matrices denoting the nominal model of the system; $\{A, B\}$ is controllable, the matrix A is not fixed, but change as

functions of state variables, thus making the model nonlinear [29]. The used system parameters are shown in Table 1 [28]. In this paper, this system is described by a TS fuzzy representation with the angular speed ω_t as the premise variable

Rule i^{th} : IF ω_t is N_1^i

$$\begin{aligned} \text{Then } \dot{x}(t) &= A_i x(t) + B_i u(t) + w_I, \\ y(t) &= c x(t) \quad \text{For } i=1, 2 \end{aligned} \quad (31)$$

Table 1: System parameters

Rated power	600 [kW]
The radius of the turbine L	35 [m]
Air density ρ	1.225 [kg /m3]
Rated wind speed	12.35 [m/s]
Cut-in speed	4 [m/s]
Cut-out speed	25 [m/s]
The stiffness coefficient k	16.8570 N.ms/rad
The shaft damping d	3324.2 N.ms/rad
The generator inertia J_G	63.857 kg.m2
The turbine inertia J_T	82988 kg.m2
The friction coefficient f_T	0.3071 kg.m /s
The friction coefficient f_G	399.1060 kg.m /s

where N_1^i is a fuzzy term of rule i . The degree of

membership function for state ω_t is depicted in Fig.3.

Then, the system dynamics is described by

$$\dot{x}(t) = \sum_{i=1}^2 \mu_i(x(t)) [A_i x(t) + B_i u(t) + w_I] \quad (32)$$

where $x(t) \in R^{3 \times 1}$, $u(t) \in R^{1 \times 1}$, w_I are the state vectors, the control input, and the disturbance signal, respectively. Where

$$A_1 = \begin{bmatrix} -0.1995 & 0 & -1.205 * 10^{-5} \\ 0 & 6.51 & 0.01566 \\ 3321 & 101.3 & -0.2536 \end{bmatrix}$$

$$A_2 = \begin{bmatrix} -0.0083 & 0 & -1.205 * 10^{-5} \\ 0 & 6.51 & 0.01566 \\ 3324.1 & 101.3 & -0.2536 \end{bmatrix}$$

$$B_1 = B_2 = \begin{bmatrix} 0 & -0.01566 & 0.2538 \end{bmatrix}^T \quad (33)$$

5.2. Sensor Fault Detection and Isolation

The objective of this part is to generate residuals that reflect the faults acting on the system (32). An ideal residual signal should remain zero in the fault-free case and non-zero when fault occurs. Once a fault has been detected, it must be estimated. The fault estimation will specify the type of fault, its duration, its amplitude and eventually its probable evolution. In the literature, there are several fault detection techniques. They are

generally based on the change detection of the average and the variance. In this FDI study, we will not deal with the detection thresholds of residuals. We will confine ourselves only to the detection and localization of sensor. In order to identify the sensor fault, we consider that the output vector $y(t)$ is corrupted by the sensor fault Δy . Then the system (30) becomes:

$$\begin{aligned} \dot{x}(t) &= \sum_{i=1}^2 \mu_i(x(t)) [A_i x(t) + B_i u(t) + w_I] \\ y(t) &= c x(t) + \Delta y \end{aligned} \quad (34)$$

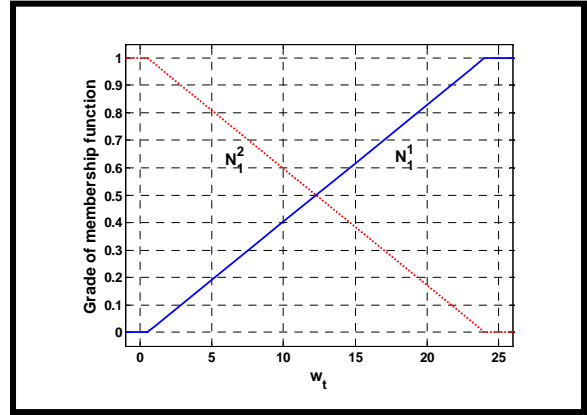

Figure 3: Membership Functions of State ω_t

5.3. Fault Specification

The three faults considered for the generator speed sensor are: proportional error, fixed output, and no output [30]. These faults are modeled separately in the next subsections.

5.3.1. Proportional Error on Generator Speed Sensor

A proportional error on the generator speed sensor changes the sensor gain as shown below.

$$\omega_{G,mes}(k) = (1 + \alpha_{pe}(k)) \omega_G(k) + v_{\omega_g}(k) \quad (35)$$

Where $\omega_{g,mes}(k)$ is the generator speed measurements [rad/s]. α_{pe} determines the proportional error[,] and is given by $\alpha_{pe} \in [-0.1 \quad 0.1]$. $(1 + \alpha_{pe}(k))$ is sensor gain. $v_{\omega_g}(k)$ is a zero mean Gaussian distributed noise

sequence with variance $\sigma_{\omega_g}^2(k)$. The fault can either be a result of a faulty configuration of a sensor or be incipient faults.

5.3.2. Fixed Output From Generator Speed Sensor

A fixed output from the generator speed sensor is an abrupt fault, which can happen at any time resulting in the following measurement equation.

$$\omega_{G,mes}(k) = \omega_{G,mes}(k_f) \quad \forall k > k_f \quad (36)$$

5.3.3. No Output From Generator Speed Sensor

No output from a generator speed sensor results in the same changes in the measurement equation as a fixed output does. In contrast to a fixed output the control system is notified when no output is received from the sensor. The three faults are also considered for the blade rotor speed sensor.

6. Fuzzy Observer Model For The Described Systems

Firstly we can easily checked that the following necessary conditions are satisfied: $i \in \{1, 2, 3\}$, $j \in \{1, 2\}$ Rank $(A_i, C(j, :)) = 3$. The fuzzy observer is designed to estimate the system output and generate the residual signal. Three TS observers are designed as shown in Fig. 4, the first is based on the turbine rotational speed $y_1 = \omega_t$, the second is based on the generator speed $y_2 = \omega_G$ and the last is based on the two outputs ω_t and ω_G .

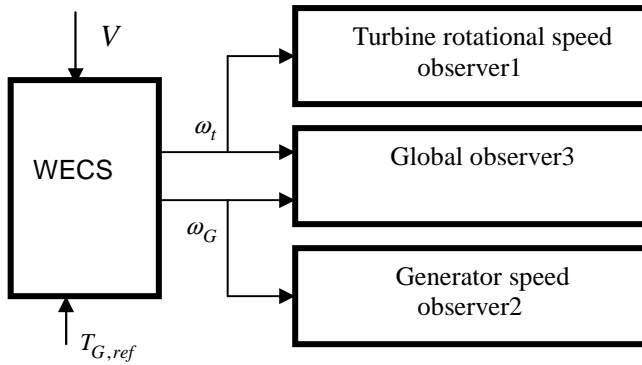

Figure 4: Block diagram of the WECS observer-based FDI

The sensor fault detection and localization is based on the analysis of the residuals $r_{yik} = y_i - \hat{y}_{i,k}$ $k \in \{1, 2, 3\}$, $i \in \{1, 2\}$ generated by three observers (Fig.4) which depend on two inputs $T_{G,ref}$ and V applied to the system (29). The turbine rotational speed observer1 and the generator speed observer2 use respectively only one output ω_t and ω_G . The global observer3 uses two outputs ω_t and ω_G .

In this way, the following residual signals are generated:

$$\begin{aligned} \Delta y_1 &= \Delta \omega_t = r_t = \omega_t - \hat{\omega}_t \\ \Delta y_2 &= \Delta \omega_G = r_G = \omega_G - \hat{\omega}_G \end{aligned} \quad (37)$$

7. Simulations and Results

According to Eq. (35), Fig.5 shows the proportional error of the generator speed sensor in the rated wind speed that represents sensor failure between $t=40s$ and $t=50s$.

7.1 FDI Using Global Observer3 and Generator Speed Observer2

The simulation results of the fault detection and isolation based on the observer3 and the observer2 are illustrated by the Fig.6 and Fig.7 with the initial conditions $(\omega_t(0) \ \omega_G(0) \ T_G(0)) = (0.35 \ 0.3 \ 0)$ and $(\hat{\omega}_t(0) \ \hat{\omega}_G(0) \ \hat{T}_G(0)) = (2 \ 10 \ 1)$. The residuals $(\omega_t - \hat{\omega}_t)$ and $(\omega_G - \hat{\omega}_G)$, $i = 1, 2$ show that there are sensor failures without being able to locate them since the corresponding observers depend on the faulty output $y_2 = \omega_G$

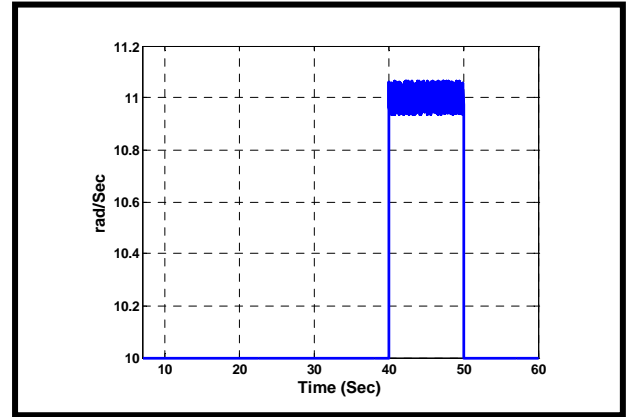

Figure 5: Proportional error on the generator speed sensor $\Delta y_2 = \Delta \omega_G$

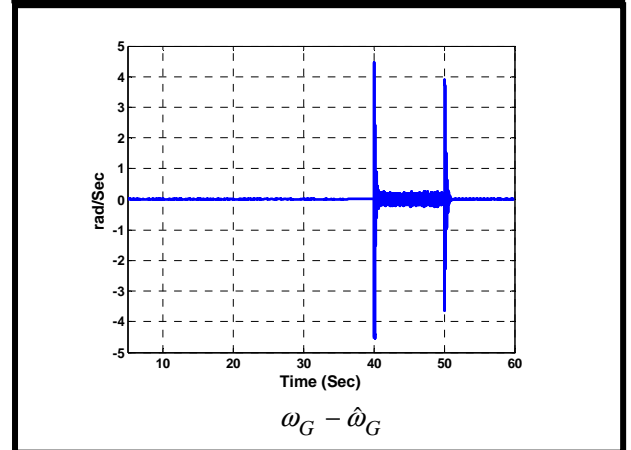
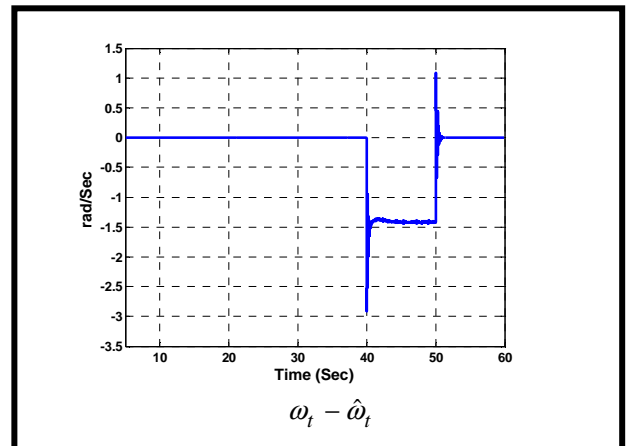

Figure 6: Sensor fault detection and isolation using observer2

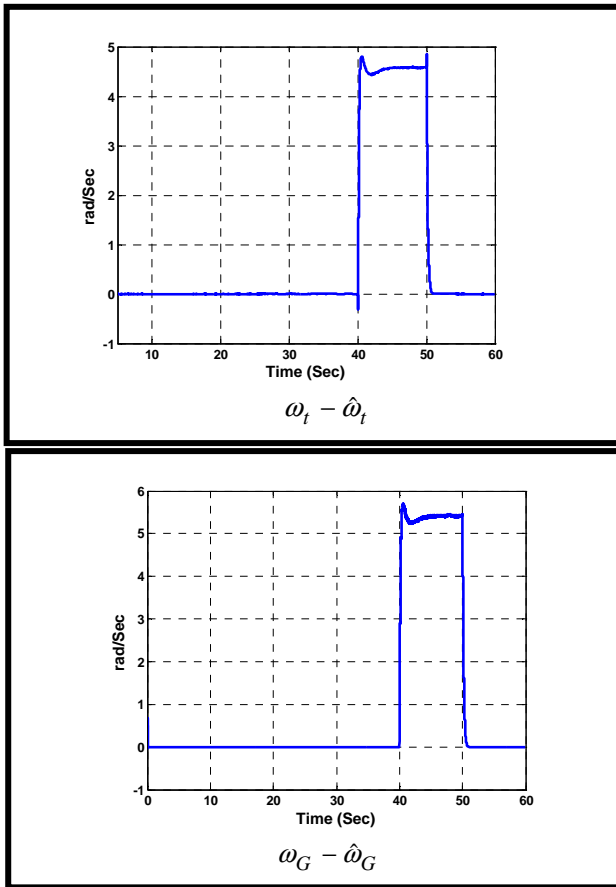

Figure 7: Sensor fault detection and isolation using observer3

7.2 FDI Using Turbine Rotational Speed Observer1.

The simulation results of the fault detection and isolation based on the observer1 are illustrated by the Fig.8. The residuals $(\omega_t - \hat{\omega}_t)$ and $(\omega_G - \hat{\omega}_G)$ generated by the observer1 allow to detect and locate the fault sensor on the generator speed output ω_G . Thus the fault detection and localization is possible by these three observers

8. Conclusion

In this paper, based on a TS fuzzy model representation, the design of fault diagnosis is proposed. The synthesis conditions lead to the resolution of an LMI problem. Moreover, the estimation of the residual signals for wind energy conversion systems is considered. The proposed observer is then used for state estimation and for detection and isolation of faults which can affect WECS models. The fuzzy observer used in this paper is based on the combination of the TS fuzzy model and the idea of PDC. The effectiveness of the proposed methodology is illustrated by estimating the generator speed and faults of wind energy conversion systems. It can be concluded that the fuzzy observer is an effective tool to generate residual signals for WECS fault diagnosis. The scope of application of this work extends to all WECS with parametric uncertainties and possible faults.

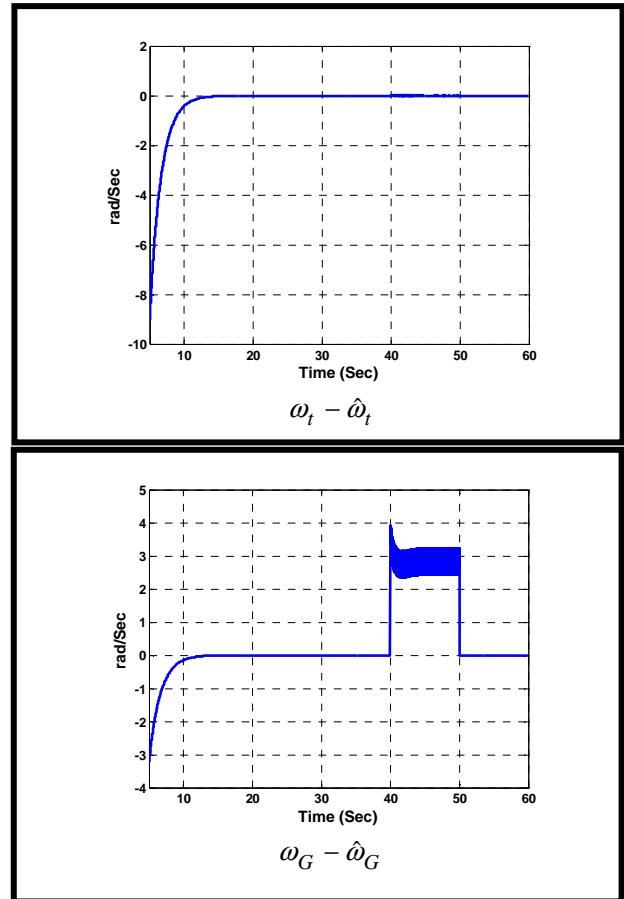

Figure 8: Sensor fault detection and isolation using observer1

References

- [1] X. Yao, C. Guo, M. Zhong, Y. Li, G. Shan, and Y. Zhang, "Wind Turbine Gearbox Fault Diagnosis Using Adaptive Morlet Wavelet Spectrum", Intelligent Computation Technology and Automation, 2009. ICICTA '09. Second International Conference, vol.2, pp. 580- 583, 2009.
- [2] C. Changzheng, S. Changcheng, and Z.Yu, "Fault Diagnosis for Large-scale Wind Turbine Rolling Bearing Using Stress Wave and Wavelet Analysis", Proceedings of the Eighth International Conference vol.3, pp. 2239-2244, 2005.
- [3] S. Yang; W.Li, and C. Wang, "The intelligent fault diagnosis of wind turbine gearbox based on artificial neural network", Condition Monitoring and Diagnosis, 2008. CMD 2008. International Conference, pp. 1327-1330, 2008.
- [4] Z. Hameeda, Y. Honga, Y. Choa, S. Ahnb, and C. Song, "Condition monitoring and fault detection of wind turbines and related algorithms: A review", Renewable and Sustainable Energy Reviews, vol.13, no.1, pp. 1-39, 2009.
- [5] Y. Amirat, M.E.H. Benbouzid, E. Al-Ahmar, B. Bensaker, S. Turri, "A brief status on condition monitoring and fault diagnosis in wind energy conversion systems", Renewable and Sustainable Energy, pp.2629-2636, 2009.

- [6] Y. Amirat, M.E.H. Benbouzid, B. Bensaker, and R. Wamkeue, "Condition monitoring and fault diagnosis in wind energy conversion systems", In: Proceedings of the IEEE IEMDC, pp. 1434–439, 2007.
- [7] Y. Amirat, M.E.H. Benbouzid, B. Bensaker, and R. Wamkeue, "Condition Monitoring and fault Diagnosis in Wind energy conversion System: A Review", IEEE International Electric Machines & Drives Conference, IEMDC, pp. 1434 - 1439, 2007.
- [8] X. Wei, M. Verhaegen, and T. van den Engelen, "Sensor fault diagnosis of wind turbines for fault tolerant", In Proceedings of the 17th World Congress The International Federation of Automatic Control, pp.3222–3227, Seoul, South Korea, July 2008.
- [9] C. Dobrila and R. Stefansen, "Fault tolerant wind turbine control. Master's thesis, Technical University of Denmark, Kgl. Lyngby, Denmark, 2007.
- [10] P. F. Odgaard, J. Stoustrup, R. Nielsen, and C. Damgaard, "Observer based detection of sensor faults in wind turbines", In Proceedings of European Wind Energy Conference 2009, Marseille, France, March 2009.
- [11] P. Poure, P. Weber, D. Theilliol, and S. Saadate, "Fault-tolerant power electronic converters", Reliability analysis of active power filter. In P. Weber, editor, Proc. IEEE International Symposium on Industrial Electronics ISIE, pp. 3174-3179, 2007.
- [12] H. Guolian, J. Pan, W. Zhentao, and Z. Jianhua, "Research on Fault Diagnosis of Wind Turbine Control System Based on Artificial Neural Network", Proceedings of the 8th World Congress on Intelligent Control and Automation, Jinan, China, pp. 4875-4879, 2010.
- [13] Li Peng, and Liu Lei "The Application and Research of the Intelligent Fault Diagnosis for Marine Diesel Engine" Proceedings of the IEEE/ASME, pp. 74-77, 2008.
- [14] Yu . Xiaodong, and H. Zang; "Transformer fault diagnosis based on rough sets theory and artificial neural networks", Condition Monitoring and Diagnosis, 2008. CMD 2008. International Conference , pp.1342-1345, 2008.
- [15] W.Zhe, and G. Qingding, "The Diagnosis Method for Converter Fault of the Variable Speed Wind Turbine Based on the Neural Networks", Innovative Computing, Information and Control, 2007. ICICIC '07. Second International Conference , pp. 613-615, 2007.
- [16] O. Wallmark, L. Harnefors, and O. Carlson, "Control algorithms for a fault-tolerant PMSM drive," IEEE Trans. Ind. Electron., vol. 54, no. 4, pp. 1973–1980, Aug. 2007.
- [17] A. M. Mendes and A. J. Marques Cardoso, "Fault-tolerant operating strategies applied to three-phase induction-motor drives," IEEE Trans. Ind. Electron., vol. 53, no. 6, pp. 1807–1817, Dec. 2006.
- [18] A. M. Mendes and A. J. Marques Cardoso, "Fault-tolerant operating strategies applied to three-phase induction-motor drives," IEEE Trans. Ind. Electron., vol. 53, no. 6, pp. 1807–1817, Dec. 2006.
- [19] A. Bellini, F. Filippetti, G. Franceschini, C. Tassoni, R. Passaglia, M. Saottini, G. Tontini, and M. Giovannini, "On-field experience with online diagnosis of large induction motors cage failures using MCSA," IEEE Trans. Ind. Electron., vol. 38, no. 4, pp. 1045–1053, Jul./Aug. 2002.
- [20] S. Bachir, S. Tnani, J.-C. Trigeassou, and G. Champenois, "Diagnosis by parameter estimation of stator and rotor faults occurring in induction machines," IEEE Trans. Ind. Electron., vol. 53, no. 3, pp. 963–973, Jun. 2006.
- [21] S. Karimi, A. Gaillard, P. Poure, and S. Saadate, "FPGA-based real time power converter failure diagnosis for wind energy conversion systems," IEEE Trans. Ind. Electron., vol. 55, no. 12, pp. 4299-4308, Dec. 2008.
- [22] S. Karimi, A. Gaillard, P. Poure, and S. Saadate, "Current Sensor Fault-Tolerant Control for WECS With DFIG ", IEEE Trans. Ind. Electron., vol. 56, no. 11, pp. 4660-4670, 2009.
- [23] V. F. Montagner, R. C. L. F. Oliveira, and Pedro L. D. Peres, "Convergent LMI relaxations for quadratic stabilizability and H^∞ control of Takagi-Sugeno fuzzy systems ", IEEE Trans on Fuzzy Systems, vol. 17 no.4, pp. 863-873, 2009.
- [24] B. Ding, "Stabilization of Takagi–Sugeno Model via Nonparallel Distributed Compensation Law", IEEE Trans on Fuzzy Systems, vol.18, no.1, pp.188-194, 2010.
- [25] C. Ghorbel, A. Abdelkrim, and M. Benrejeb, "Takagi–Sugeno (TS) fuzzy model, linear matrix inequalities (LMI), quadratic Lyapunov function, fuzzy observers, unmeasurable premise variables", Control and Intelligent Systems, 2010.
- [26] M. Xiao-Jun, S. Zeng-Qi, and H. Yan-Yan, "Analysis and Design of Fuzzy Controller and Fuzzy Observer", IEEE Trans on Fuzzy Systems, vol.6, no.1, 1998.
- [27] H. O. Wang, K. Tanaka, and M. F. Griffin, "An approach to fuzzy control of nonlinear systems: stability and the design issues," IEEE Trans. Fuzzy Syst., vol. 4, no. 1, pp.14-23, 1996.
- [28] X. Yang and X. Liu Qiang Wu, "Integral Fuzzy Sliding Mode Control for Variable Speed Wind Power System", Proceedings of the IEEE International Conference on Automation and Logistics August 18 - 21, Jinan, China, pp.1289-1294, 2007.
- [29] K. Hee-Sang, J. Jatskevich, "Power Quality Control of Wind- Hybrid Power Generation Using Fuzzy-LQR Controller", IEEE Transactions on Energy Conversion, vol. 22, no.2, pp. 516-527, 2007.
- [30] Thomas Esbensen, Christoffer Sloth and Jakob Stoustrup, "Fault Diagnosis and Fault-Tolerant Control of Wind Turbines", Project period: September 5th 2008 - June 3rd 2009.