



HAL
open science

Comparison of spatial math models for tolerance analysis: tolerance-maps, deviation domain and TTRS

Gaurav Ameta, Serge Samper, Max Giordano

► To cite this version:

Gaurav Ameta, Serge Samper, Max Giordano. Comparison of spatial math models for tolerance analysis: tolerance-maps, deviation domain and TTRS. *Journal of Computing and Information Science in Engineering*, 2011, 11 (2), pp.1-8. 10.1115/1.3593413 . hal-00801640

HAL Id: hal-00801640

<https://hal.science/hal-00801640v1>

Submitted on 16 Jul 2024

HAL is a multi-disciplinary open access archive for the deposit and dissemination of scientific research documents, whether they are published or not. The documents may come from teaching and research institutions in France or abroad, or from public or private research centers.

L'archive ouverte pluridisciplinaire **HAL**, est destinée au dépôt et à la diffusion de documents scientifiques de niveau recherche, publiés ou non, émanant des établissements d'enseignement et de recherche français ou étrangers, des laboratoires publics ou privés.

Comparison of Spatial Math Models for Tolerance analysis: Tolerance-Maps, Deviation Domain and TTRS

Ameta G.¹, Samper S.² and Giordano M.²

¹School of Mechanical and Materials Engineering, Washington State University, Pullman, WA 99164-2920

gameta@wsu.edu

²Universite de Savoie, BP 806, Annecy, Cedex, 74016, France.

Abstract

This paper presents a comparison of Degree Of Freedom (DOF) based math models, viz., Tolerance-Maps, Deviation Domain and TTRS, that have shown most potential for retrofitting the nuances of the ASME/ISO tolerance standards. Tolerances specify allowable uncertainty in dimensions and geometry of manufactured products. Due to these characteristics and application of tolerances, it is necessary to create a math model of tolerances in order to build a computer application to assist a designer in performing full 3-D tolerance analysis.

Many of the current efforts in modeling tolerances are lacking, as they either do not completely model all the aspects of the ASME/ISO tolerance standards or are lacking the requisite full 3-D tolerance analysis. Some tolerance math models were developed to suit CAD applications used by the designers while others were developed to retrofit the ASME/ISO tolerance standard. Three math models developed to retrofit the ASME/ISO standard, Tolerance-Maps, Deviation Domain and TTRS are the main focus of this paper. Basic concepts of these math models are summarized in this paper, followed by their advantages and future issues. Although these three math models represent all aspects of the ASME/ISO tolerance standard, they are still lacking in one or two minor aspects.

1. INTRODUCTION

1.1 Background and Importance of Tolerances

Manufacturing invariably leads to uncertainty in dimensions and geometry of manufactured products. Usually, products with higher precision (dimensional and geometric) cost more than the products with lower precision. A designer specifies the dimensions and geometry of the manufactured product, while satisfying functional and other constraints for the product. Therefore, the designer must also specify the amount of uncertainty in dimensions and geometry of the manufactured product. The amount of uncertainty in dimensions and geometry of the manufactured product is specified through tolerances.

The modern method of specifying tolerances is through geometric dimensioning and tolerancing (GD&T), as indicated in the ASME Y14.5 and ISO 1101 standards [1,2]. According to the Standards [1,2], the variations of a feature are bounded within tolerance zones that permit

locational, orientational, form, profile, runout and symmetry variations of the feature in 3-dimensions. Figure 1 shows different classes of tolerances and associated symbols.

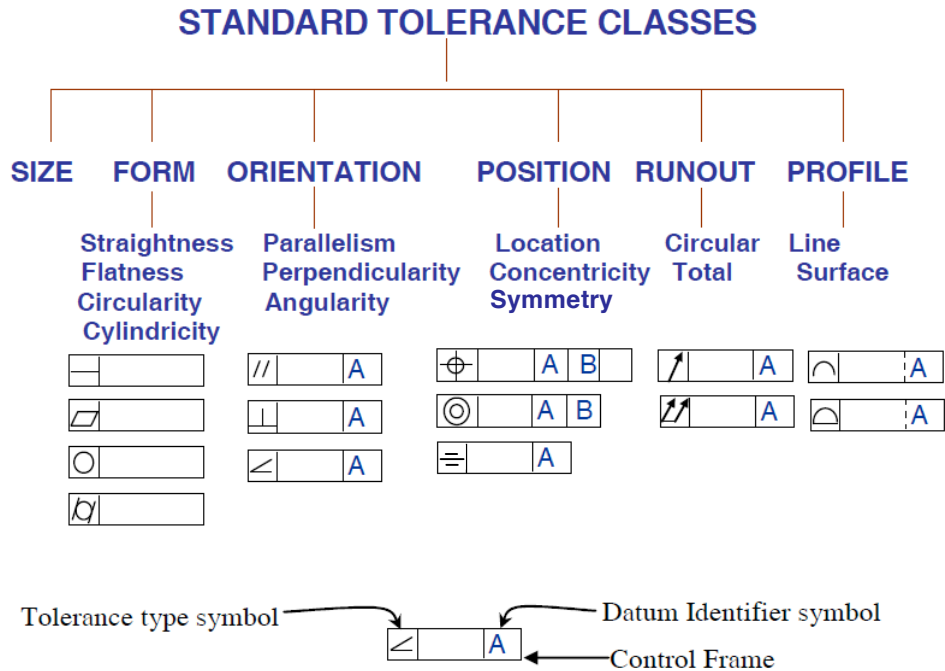

Figure 1: Different classes of tolerances in the standards [1].

In the present era tolerances affect the cost of production, inspection procedure, assemblability, performance, sensitivity, selection of process, process related tools and fixtures. The selection of type and value of tolerances for a part or an assembly is an important issue for any manufacturing firm as it affects decision-making processes at all the echelons of a production cycle. Therefore, a designer should discern the need and the effect of tolerances that he/she selects.

Usually, a designer can arrive at initial/preliminary set of tolerances by utilizing (a) design history from similar products and (b) trial and error. The initial value of tolerances can be optimized for cost and function of the product using one of two approaches: (a) tolerance analysis or (b) tolerance synthesis [3]. With analysis, the designer estimates values for individual tolerances on a target feature for each dimension in a 'stackup', and then uses an analysis tool, often automated on a computer, to determine the contribution from each of these tolerances to the accumulation of variations at one or more functional target features of the entire stackup. (Note that a 'stackup' is a dependent relationship among dimensions that may all reside on one part, or be distributed over several parts in an assembly.) With synthesis, often called tolerance allocation, the desired control (e.g. a range of clearance to ensure proper lubrication or control of noise) at the target feature is chosen, and often ratios among tolerances are also chosen, to

minimize cost of manufacture. Then, the tolerances are generated from the math model to meet these choices. Tolerance analysis and allocation can be done using a worst-case method or a statistical method. With the worst-case approach, the tolerances chosen will ensure 100% acceptability of the assemblies; with the statistical method, the tolerances chosen will ensure acceptability of a certain large percentage of assemblies. The statistical method allows a tradeoff between bigger variations at all the parts, and a correspondingly lowered cost of their manufacture, and a small number of assemblies for which the variations at the target feature(s) are not within acceptable limits.

1.2 Need for Math Model of Tolerances

Current tools for assisting designers in assigning satisfactory set of tolerances (tolerance analysis) are neither comprehensive nor accurate. The designer either uses manual/automated tolerance charts or simulation based commercial tolerance analysis tools. Tolerance charting is consistent with ASME/ISO standards [1,2], but limited to 1-D worst case analysis only. Simulation based commercial tolerance packages typically perform both worst case and statistical analysis, but are based on point-to-point constraint solving and therefore incompatible with the tolerance standards that specify variation within tolerance zones. Comprehensive 3D analysis of stack-ups involving all types of dimensional and geometric variations is only possible if a mathematical model of such variations exist.

The current international standards are created by collecting knowledge from years of engineering practice and are therefore case-based for each individual feature type and tolerance type. Emerging methods are attempting to address the challenge to build a math model of geometric variations that is consistent with already existing tolerance standards and capable of supporting comprehensive 3D analysis of stack-up conditions.

Many different methods for math models of the standard for tolerance analysis have been approached in the literature, which will be discussed in brief in section 2.2. For a detailed and comprehensive review of tolerance analysis methods please refer to other review articles [3-8]. Three spatial math models for tolerance analysis have seen the most development, and have been pursued consistently, by the researchers, in the last decade. The only focus of this paper is these *three* spatial math models for tolerance analysis, viz., Tolerance-Map, Deviation Domain and TTRS (Technologically and Topologically Related Surfaces) model. The next section presents basics of tolerance analysis and various research efforts related to tolerance

analysis. Section 3, provides an overview of three math models for tolerance analysis, while section 4 compares the three math models.

2. TOLERANCE ANALYSIS

2.1 Basics of Tolerance Analysis

The objective of tolerance analysis is to check the extent and nature of the variation of an analyzed dimension or geometric feature of interest for a given GD&T scheme. The variation of the analyzed dimension arises from the accumulation of dimensional and/or geometric variations in the tolerance chain. The analysis include: (1) the contributors, i.e., the dimensions or features that cause variations in the analyzed dimension, (2) the sensitivities with respect to each contributor, (3) the percent contribution to variation from each contributor, and (4) worst case variations, statistical distribution, and acceptance rates.

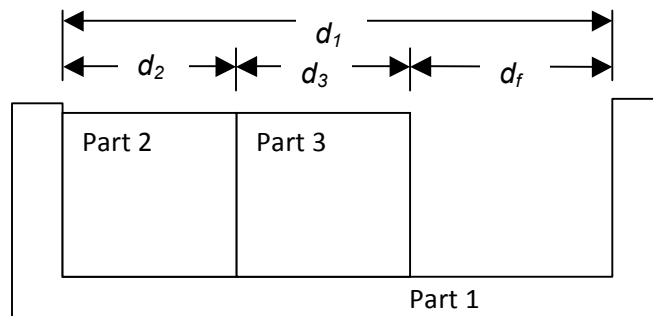

Figure 2. A simple 1-dimensional example showing tolerance analysis with only dimensional tolerances.

For example, consider the assembly of three parts shown in Figure 2. Dimensions d_1 , d_2 and d_3 are known dimensions with associated dimensional tolerances ($\pm t_1/2$, $\pm t_2/2$ and $\pm t_3/2$). Dimension d_f is the dimension of interest for the assembly. It is quite evident that

$$d_f = d_1 - (d_2 + d_3) \quad (1)$$

Correspondingly, the worst cast variation of dimension d_f can be identified by the tolerance t_w

$$t_w = t_1 + t_2 + t_3 \quad (2)$$

The contributors are dimensions d_1 , d_2 and d_3 . All the three dimensions have equal sensitivities (1) and equal contribution (0.33). The worst case variation is $d_f + t_w/2$ and $d_f - t_w/2$. For statistical

tolerance analysis, root sum of squares method from statistics is utilized leading to equation (3) under the following assumptions:

1. d_i parameters are independent random variables
2. the index capability $C_p = t_i/(6 SD_i)$ has the same value for all t_i and t_s . SD_i are the standard deviations of d_i and d_f .

$$t_s^2 = t_1^2 + t_2^2 + t_3^2 \quad (3)$$

The above scheme is only suitable for such simple linear chains with only dimensional tolerances. Addition of geometric tolerances, with their nuances, and non-linear chains complicates the tolerance analysis procedure. Although, some simple linearization or rule based methods have been developed to tackle tolerance analysis, but these methods fall short in achieving full 3-D tolerance analysis with geometric tolerances.

2.2 Various Research efforts in Tolerance Analysis

Various research efforts in tolerance analysis can be classified into two major categories. Tolerance representations retrofitted for CAD and retrofitted to model variations, as specified by the standards. Furthermore, the classification of research efforts for developing a math model of standard as given by Davidson *et. al* [9], can be reclassified into the two categories of research efforts in tolerance analysis. Parametric models, offset zone models and variational surfaces based models are representations retrofitted for CAD, while kinematic models and Degrees of Freedom based models are representations retrofitted for variations as specified by the standards. Other recent reviews in tolerance analysis have been conducted for Jacobean and torsor models [10], and matrix and vector models [11]. A brief description of these research efforts is presented below.

2.2.1 Tolerance models retrofitted for CAD: Initial efforts, during 1980's, utilized parametric CAD to develop models for tolerance analysis. These models can be called parametric models for tolerance analysis. Parametric CAD utilizes a set of explicit dimensions and constraints to represent nominal shape and size. These explicit dimensions and constraints can be used to obtain a set of equations relating the dimension of interest to individual chain of dimensions. Tolerances are incorporated by allowing +/- variations in the dimensions [12,13].

As is evident, this method is similar to the 1-dimensional tolerance analysis discussed in section 2.1. Limitations of attributed to parametric methods include inability (a) to incorporate to all geometric tolerances in the standard and their interactions and (b) to conduct full 3D tolerance analysis.

About the same time, researchers attempted to model the concept of tolerance zone for tolerance analysis, by creating zones for the tolerated features in a CAD model. The main idea was to model tolerance zone as Boolean subtraction of maximal and minimal object volumes that are obtained by offsetting the object by amounts equal to the tolerances on either side [14-16]. These models are called *offset zone* models for tolerance analysis. The construction of such a composite tolerance zone from boundary surfaces of the part (a) does not allow one to model each type of geometric variation separately and (b) to study their interactions as specified in the standard [1]. Various issues related to these models are also discussed in [17].

Extending the same idea of offset zone for simulating the variations of features in CAD models, *variational surfaces* based models for tolerance analysis were developed in early 1990's. Each surface is varied independently by changing the values of model variables from which surface coefficients are calculated [18,19]; positions of the vertices and edges are computed from the surface variations. When using this concept in CAD tools, it leads to some topological problems, such as (a) maintenance of tangency and (b) incidence conditions. This model too, is incompatible with the ASME Standard [1]. A modified version of this method, which uses abstracted geometry instead of the CAD model itself is utilized in various simulation based tolerance analysis tools (VSA).

2.2.2 Tolerance models retrofitted to represent variations as specified in the Standard: A different approach was adopted by Chase *et al.* [20] that incorporated kinematics to model assembly and tolerances for tolerance analysis. Such models can be classified as *kinematics* based model for tolerance analysis. Initially, Rivest *et al.* [21] utilized transformation matrices to analyze tolerance stack-up in mechanisms. Based on the idea, Chase *et al.* [5,20,22,23] developed a kinematic approach to tolerance analysis. In this approach, three types of variations (dimensional, kinematic, and geometric) are modeled in the vector loop. In a vector loop, dimensions are represented by vectors, in which the magnitude of the dimension is the length (L_i) of the vector. Kinematic variations are small adjustments between joints (mating relations), which occur at the assembly time in response to the dimensional and geometric variations. Geometric tolerances are considered by adding micro degrees of freedoms (DOFs)

to particular ones of the joints. Not all interactions of geometric tolerances have been incorporated in the model.

Extending the idea behind kinematic models, Degrees of freedom allowed by each tolerance type to each feature was being utilized by several researchers. Such models can be classified as *Degree of Freedom* based models for tolerance analysis. Kramer [24] used symbolic reasoning to demonstrate the determination of degrees of freedom of parts in an assembly and to determine assembly feasibility based on nominal dimensions. The three math models (Tolerance-Maps, Deviation Domain and TTRS) discussed in section 3, use the concept of DOF to model geometric tolerances and then utilize kinematics or transformations to assist in tolerance analysis.

3. MATH MODELS FOR TOLERANCE ANALYSIS

Although there are many different math models for tolerance analysis (see section 2.2), this paper discusses Tolerance-Maps, Deviation Domain, and TTRS briefly. All these models use substituted surfaces having no form errors and variations are represented by real variables. For details of each method, refer to the cited references in each section below.

3.1 Tolerance-Maps

A Tolerance-Map[®] (T-Map[®]) is a hypothetical Euclidean point-space, the size and shape of which reflects all variational possibilities for a target feature. It is the range of points resulting from a one-to-one mapping from all the variational possibilities of a feature, within its tolerance-zone, to the Euclidean point-space. These variations are determined by the various tolerances that are specified on the feature.

3.1.1 Areal Coordinates: The T-Map[®] for any combination of tolerances on a feature is constructed from a basis-simplex in a space of dimension n , the value of n corresponding to the freedom of movement of the feature within the tolerance-zone; it is described with areal coordinates. A classical description of this subject, a form of affine geometry, is in Coxeter [25]. To construct an n -dimensional space and its simplex, $n + 1$ basis points are needed. Therefore, for three-dimensional variations of a feature, the corresponding T-Map is constructed from four basis points that define its basis-tetrahedron. We choose to position the four basis-points σ_1 , σ_2 , σ_3 and σ_4 as shown in Figure 3. At the four basis-points we place four masses λ_1 , λ_2 , λ_3 , and λ_4 that may be positive or negative. So long as $\lambda_1 + \lambda_2 + \lambda_3 + \lambda_4 \neq 0$, the position of σ , the centroid of these masses, is uniquely determined by the linear combination

$$(\lambda_1 + \lambda_2 + \lambda_3 + \lambda_4)\sigma = \lambda_1\sigma_1 + \lambda_2\sigma_2 + \lambda_3\sigma_3 + \lambda_4\sigma_4, \quad (4)$$

and we can make σ assume any position in the space of $\sigma_1.. \sigma_4$ by varying $\lambda_1, \lambda_2, \lambda_3,$ and λ_4 . For example, for $\lambda_1.. \lambda_4$ all positive, σ identifies any point *inside* tetrahedron $\sigma_1\sigma_2\sigma_3\sigma_4$.

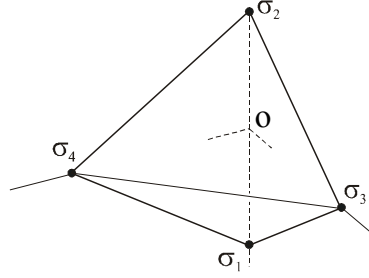

Figure 3. The basis tetrahedron with its basis points.

The four masses $\lambda_1.. \lambda_4$ are the *barycentric coordinates* of σ , yet we note that the position of σ depends only on three independent ratios of these magnitudes. Consequently, the four λ_i 's can be normalized by setting

$$\lambda_1 + \lambda_2 + \lambda_3 + \lambda_4 = 1; \quad (5)$$

then they are *areal* coordinates and

$$\sigma = \lambda_1\sigma_1 + \lambda_2\sigma_2 + \lambda_3\sigma_3 + \lambda_4\sigma_4. \quad (6)$$

The shape of the basis-tetrahedron was chosen to simplify interpretation of T-Maps, particularly to decouple rotational and translational displacements in the tolerance-zone [9].

3.1.2 Tolerance-Map for a face with size tolerance: Figure 4 shows the end of a rectangular bar of cross-sectional dimensions $d_x \times d_y$ ($d_x < d_y$). The length of the part shown is ℓ with an exaggerated tolerance t . According to the ASME Standard Y14.5 [1], all points of the end-face must lie between the limiting planes σ_1 and σ_2 , and within the rectangular limit of the face. The region (ABCDEFGH) defined by the limiting planes and the rectangular limit of the face is the tolerance-zone for the planar face. The same tolerance zone can be obtained with profile tolerance, t , specified for the planar face with respect to the opposite end (not shown in the Figure 4) of the bar.

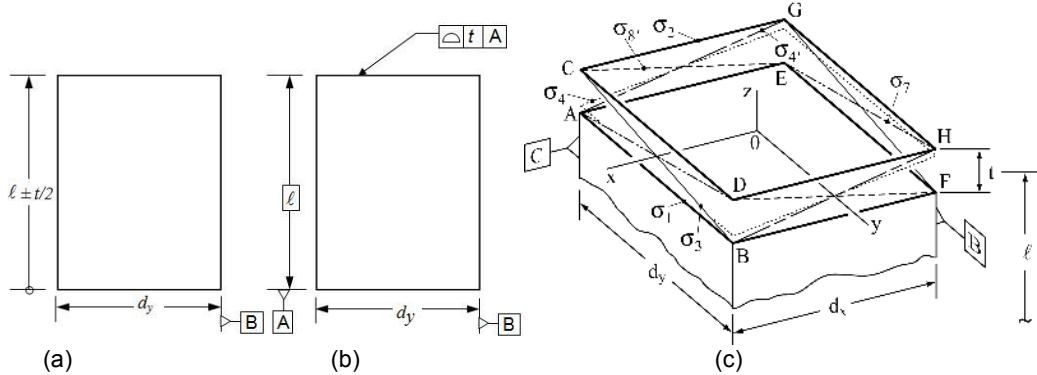

Figure 4. (a) Rectangular part with size tolerance and (b) rectangular part with profile tolerance on rectangular surface. (c) The tolerance zone on size (specification of (a)) or profile (specification of (b)) for a rectangular bar and a coordinate frame centered within it.

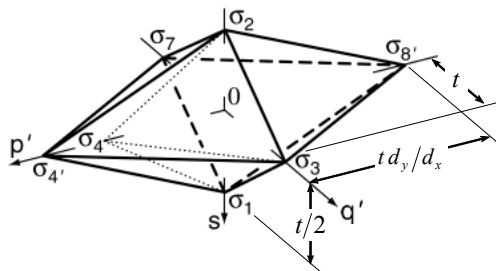

Figure 5. The T-Map for the tolerance zone shown in Figure 4(c).

In order to build the T-Map, it is assumed that the variations of the tolerated face in Figure 4 are rotations about x and y and translations along z . The shape or form of the face is assumed to be perfectly planar. A coordinate frame is located in the tolerance zone with its origin O at the geometrical center of the tolerance zone as shown in Figure 4(c). This coordinate frame has its axes parallel to the edges of the part. Presuming the face at first to be of perfect form, i.e. a rectangular *segment* of a plane, the possible placement of this face is against any one of a three-dimensional set of planes. The planes σ_1 and σ_2 are located at maximum distance from the origin of the coordinate frame in the tolerance zone. The planes σ_3 and σ_7 are rotated by the greatest allowable amount about the x -axis in the tolerance zone. Since $d_x < d_y$, the permitted angular variation about the y -axis can be greater than that about the x -axis. The planes labeled σ_4 and σ_8 are rotated about the y -axis by the same amount as the planes σ_3 and σ_7 are about the x -axis. The planes σ_4 and σ_8 are rotated the maximum amount about the y -axis in the tolerance zone. Each of these planes in the tolerance zone is then mapped to a specific point in the T-Map, as shown in Figure 5. Therefore, the construction of a T-Map

ensures that each point inside it represents a single valid configuration of the perfect-form feature within its tolerance-zone.

The T-Map for a planar face faithfully represents the 3-D variations permitted by the tolerance-zone: translation perpendicular to the plane and rotations about the x - and y - axes (Figure 4(c)). Measures along the s -axis of the T-Map represent parallel variations of the plane negatively along the z -axis in the tolerance zone, while the p' - and q' - axes represent the orientational variations of the plane about the y - and x - axes, respectively.

If the toleranced face in Figure 4 is not assumed to be perfectly planar, then the shape or form variations of the face are modeled as subsets of T-Map as shown in Figure 6. The T-Map for size tolerance t on the length of the bar remains the same as in Figure 5, but now there are two internal sub-sets, each of the same shape as in Figure 5 but of different sizes. The form variation is zero (perfect form, no warp) for the large shaded T-Map at the far left in Figure 6. As we move from left to right, the subset for size tolerance (lower shape) shrinks while the subset for form tolerance (upper shape) enlarges. This tradeoff represented through these subsets basically models Rule#1 from the ASME Y14.5 standard [1]. Further details about the T-Map model for different types of tolerances and features can be found in [9,26-31].

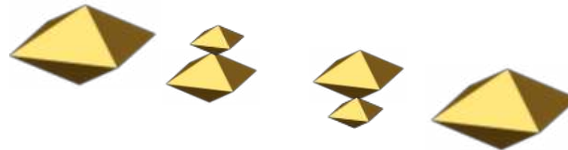

Figure 6 The tradeoff between the array of sub-sets for form and their companion locations within the T-Map of Figure 5.

3.1.3 Tolerance Analysis: Worst case tolerance analysis for assemblies with open chain and not consisting of any clearances, can be performed using the following steps

1. Identify the chain of dimensions and tolerances from the datum to the target of the assembly
2. Create T-Maps for all the toleranced features in the chain
3. Using transformation matrices, conform each T-Map to represent the variations at the target feature of the assembly
4. Combine the T-Maps using Minkowski Sum to identify the accumulated T-Map for the target feature
5. Create a T-Map for the functional requirement of the assembly. This T-Map is called functional T-Map.
6. Fit the accumulation T-Map within the functional T-Map.

- a. To verify if the assigned tolerances meet the functional requirement, the accumulation T-Map should be completely inside the functional T-Map.
- b. To identify the stack up equations, scale the functional T-Map homogeneously until at least one of the boundary points of the accumulation T-Map comes in contact to the boundary of the functional T-Map. Utilizing the geometry of the functional and accumulation T-Map, create the stack up equations.
- c. To optimize the assigned tolerances, change the types and values of tolerances on each feature such that the accumulation T-Map can fill as much space as possible while remaining confined within the functional T-Map and satisfying other design criteria.

3.2 Deviation Domain

3.2.1 Small Displacement Torsors: Each tolerance zone, allows a small amount of variations of the feature within the tolerance zone. These small amounts of variations are represented as small displacement torsor (SDT). A torsor basically represents three translations and three rotations of a feature with respect to a co-ordinate system. For example a SDT for a planar surface (Figure 4(c)) would be represented as

$$SDT_{planar} = \{t_x, t_y, t_z, r_x, r_y, r_z\} \quad (7)$$

$$t_x = t_y = r_z = 0$$

The first three elements of equation (4) represent the translations about x, y and z axis in the tolerance zone (Figure 4(c)) while the last three elements represent rotations about x, y and z axis in the tolerance zone. Because of the nature of the feature (planar surface), and the tolerance zone, translations along the x and y axis and the rotations about z axis are considered invariant.

3.2.2 Deviation and Clearance Domain: In order to represent the variations of a feature within its tolerance zone, a deviation space is created using the non-invariant components of the SDT. For the example considered in the previous section (3.1.1), a deviation domain is created using t_z , r_x and r_y parameters of the SDT. Since, the deviation domain is created for the three parameters of SDT; the domain is 3-dimensional. Furthermore, observing the tolerance zone, tolerated feature and the parameters of the SDT, inequalities representing the bounds of the tolerance zone are created. These inequalities are then used to create a bounded deviation domain. Figure 7 shows the deviation domain for the planar surface shown in Figure 4.

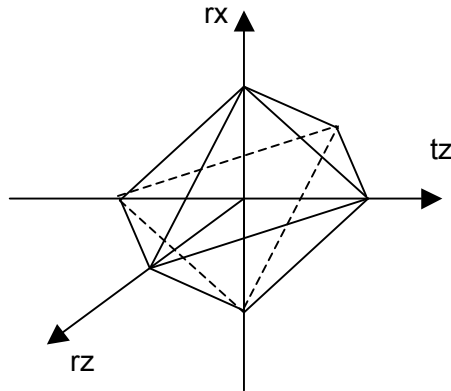

Figure 7: Deviation Domain for the planar surface in Figure 4(c).

As is evident from equation (7), there are six parameters in a torsor. Therefore, the dimensionality of a deviation domain can be six. The clearance in a joint between two parts can also be modeled by SDT called clearance torsor. A coordinate frame is attached to the two parts forming a joint with clearance. The clearance is represented as a SDT of variations of one frame with respect to another. The possible variations in clearance, when represented in the deviation space (using SDT), is called a clearance domain.

Form or shape variations are modeled using vibration modes of the tolerated feature. These vibration modes are then used to modify the deviation domain in order to represent form variations. For further details about the deviation domains models please refer to [32-38].

3.2.3 Tolerance Analysis: Worst case tolerance analysis for assemblies

- a. with open chain and not consisting of any clearances, can be performed using the following steps
 1. Identify the chain of dimensions and tolerances from the datum to the target of the assembly
 2. Create deviation domains for all the tolerance features in the chain
 3. Combine the deviation domains using Minkowski Sum to identify the accumulated deviations for the target feature
 4. Create a deviation domain for the functional requirement of the assembly. This deviation domain is called functional domain.
 5. Align the torsor parameters of the accumulated and functional domain to obtain the stack up equation for the assembly
- b. with closed chain and consisting of clearances, can be performed using the following steps

1. Identify the chain of dimensions and tolerances from the datum to the target of the assembly
2. Create deviation domains for all the tolerance features in the chain
3. Combine the deviation domains using Minkowski Sum to identify the accumulated deviations for the target feature
4. Create a minimal clearance domain (accumulated) for each joint of the chain.
5. The assembly is possible when the accumulated deviation domain remains within the accumulated clearance domain.

3.3 Technologically and Topologically Related Surfaces (TTRS)

The TTRS method utilizes several different concepts from constraints and rigid body motions to model tolerances. In classical kinematics, the constraints between the features of a point, a line, and a plane form six lower pairs of classical kinematics [39]. Hunt [40] drew attention to their use in both partial and sufficient constraint of a rigid body. Later, Desrochers and Clément [41] independently formulated the idea as six technologically and topologically related surfaces [TTRS] for use in applications of dimensioning and tolerancing. The surfaces as derived from kinematic joints are spherical, planar, cylindrical, helical, rotational and prismatic. Some authors add another surface called “any surface” to create seven TTRS.

3.3.1 MGDE/MGRS: Desrochers [42] and Clément *et. al.*, [43] have integrated TTRS to model the variations in a tolerance-zone with the use of the constraints between a point, line and plane, called “minimum geometric datum elements” (MGDE) or “minimum geometric reference surface” (MGRS).

Table 1: 13 different constraints for the MGDE/MGRS (adopted from [43])

	Point	Line	Plane
Point	C1: coincidence C2: distance	C4: coincidence C5: distance	C3: distance
Line	C4: coincidence C5: distance	C11: coincidence C12: parallel/distance C13: angle and distance	C8: perpendicularity C9: parallel/distance C10: angle
Plane	C3: distance	C8: perpendicularity C9: parallel/distance C10: angle	C6: parallel/distance C7: angle

3.3.2 Modeling tolerances: In the TTRS model, various researchers have used tensors or torsors or screws combined with some internal parameters to represent tolerances. Since, the torsor has been discussed in section 3.2.1; this section presents the screw parameters used to model tolerances.

General motion of a rigid body is defined by a screw motion about screw axis. The screw motion, also called a twist, is represented by three angular velocities ω and three linear velocities v . A general representation of screw is given below

$$T = (\omega_x, \omega_y, \omega_z; v_x, v_y, v_z) \quad (8)$$

In the manner similar to torsors, the screw parameters are then used to represent small displacement screws within the tolerance zone for modeling variations of each MGDE. For further details please refer to [44].

3.3.3 Tolerance Analysis: Worst case tolerance analysis for assemblies with open and parallel stack ups can be performed using the following steps,

1. Create TTRS graph for the assembly with MGDE/MGRS surfaces identified
2. Create Geometric tolerance TTRS graph, including the TTRS datum and toleranced TTRS (tolerance element and tolerance zone)
3. The toleranced TTRS will lead to the modeling of tolerances based on tensors, torsors or screws and several internal parameters.
4. Combine the tensors/torsors/screws parameter limits of all the toleranced TTRS along the stack path/paths in the assembly.
5. Using the target features tolerance TTRS, identify the limiting parameter direction.
6. The sum of all the parameters in the combined tensors/torsors/screws along the limiting parameter direction will lead to worst case tolerance for the target feature.

4. Comparison of the three math models

In order to compare the three math models discussed in section 3, the most important criteria is modeling GD&T in a manner that completely includes every aspect or nuance of the standard for tolerances. These aspects include representing (a) all tolerance types in relation to the valid feature type, (b) all valid and possible interactions and (c), datum precedence and order of datum are identified in the specified feature control frame. Other aspects include the procedure for worst case and statistical case tolerance analysis. Table 2 shows the comparison of the three math models based on these criteria.

Table 2: Comparison of Math models for tolerance modeling and analysis

	TTRS	T-Maps	Deviation Space
Modeling GD&T	Intrinsic parameters and Small	Homogenized multi-dimensional	Domains in the space of the torsors (6 dimensions maxi)

	Displacement Torsors	parameter space using areal coordinates	
Tolerance types	Modeled individual tolerance zone types related to each feature type and not tolerance types	Except profile all modeled including pattern tolerances	Except profile all modeled including pattern tolerances
Interactions	Not modeled	Rule#1, MMC, LMC, RFS, bonus, shift and interaction of orientation, form and location also modeled	Interaction of orientation, form and location, MMC, LMC and projected tolerance zone is also modeled.
Datum precedence	Successfully modeled	Successfully modeled	Successfully modeled
Worst-Case Analysis	Parameter inequalities along particular SDT parameter axis directions for analysis	Conformation of maps to target, Minkowski sum, fitting with functional T-Map,	Serial and parallel mechanism analysis
Statistical-Analysis	RSS method along the SDT parameter axis selected in worst-case	Convolution of probabilistic T-Maps and then intersection with a surface (representing dimension of interest) to generate frequency distribution for dimension of interest.	Statistical clearance-domains for parallel assemblies
References	[41,42,45-47]	[9,26-31,48-51]	[32-38]

Although TTRS and Deviation Domains both use torsors to model geometric tolerances, TTRS also utilizes intrinsic parameters. Tolerance-Map does not utilize torsors and uses areal coordinates to create the hypothetical space and then overlays homogenized coordinates from the allowable DOF of a feature within the tolerance zone. A very important difference between

the Tolerance-Maps and Deviation Domains is that T-Maps have all the axes (in the hypothetical Euclidean space) of the same units (length units) while Deviation Domains can have axes of different units (angle and length units). Such homogenization of the axes, allows the T-Map model to compare two different specifications on the same feature in terms of the volume of the T-Map [28]. The larger the volumes of the T-Map, the greater number of variations are allowed by the specification.

In the TTRS model, interactions of tolerances as prescribed in ASME and ISO standard has not been represented, while in the T-Map and Deviation Domain model, profile tolerances have not been modeled. Datum precedence has been successfully characterized in all three models.

Worst-case tolerance analysis in the TTRS and Deviation domain model has been demonstrated for series and parallel stack ups, while T-Map model has been demonstrated for series stack ups with limited application for parallel stack ups. Statistical analysis in the TTRS model is conducted using RSS of the stack dimensions. In the deviation domain model, statistical clearance domains are identified, which are then used to conduct statistical tolerance analysis. In the T-Maps model, each T-Map in the stack up is converted into a probabilistic T-Map. These T-Maps are then convolved together to obtain a convoluted accumulation T-Map. A surface for the dimension of interest is identified and intersected with the convoluted accumulation T-Map to obtain frequency distribution of the dimension of interest. The frequency distribution for the dimension of interest is used to provide results for statistical tolerance analysis. Furthermore, TTRS and deviation domain models have shown the ability to represent rigid as well as elastic or flexible parts/components, whereas in the T-Maps model, all parts are assumed to be rigid. T-Maps model has shown the capability to representing floating assembly constraints in tolerance analysis [52], while deviation domain model has shown the capability to represent non-rigid parts/components.

5. Discussion and Future Issues

Each of the models discussed in this paper, represents an advantage over the other in at least one aspect or another. These three models are similar, having quite the same assumptions, even if they use different mathematical formalism. Although, none of the models are complete, as yet, in representing all geometrical tolerances specified in the standard, the models assist a designer in bringing forth nuances from the standard as applicable to tolerance analysis.

Recent publications in tolerances have concentrated on methods for simulating manufacturing variations for specified tolerances [53], tolerance synthesis methods [54-56] and flexible or elastic components [57]. Therefore, the issues that need to be addressed in these models are (a) representing profile and symmetry tolerances, (b) multiple stack up chains (in T-Maps model), (c) Elastic or flexible components (in T-Maps model), (d) represent tolerance interactions completely (TTRS and Deviation Domains), (e) floating mating conditions, and (f) candidate Datum or derived datum sets. Floating mating conditions represent assembly of two parts when the parts are not rigidly fixed to one another, but can float (move) while satisfying assembly constraints. Candidate datum or derived datum is defined in the ASME Y14.5 standard [1] as “the set of all candidate datums that can be established from a datum feature”. The candidate datum or derived datums are needed as the datums themselves are not of perfect form/shape. Therefore, the real datums are replaced by simulated perfect datums in order to conduct tolerance analysis. These issues have not been addressed by the three spatial models discussed in this paper. Of the three models discussed in this paper, deviation domain model has the potential to address this issue by utilizing the modes of vibrations of a surface to represent the form variations.

A larger issue is integration of tolerances in design, manufacturing and inspection (tolerance evaluation). Although, some efforts [42,56] have been made in these three models for integrating design, manufacturing and inspection from tolerancing perspective, but a holistic approach needs to be developed that can incorporate the nuances of tolerancing from design, manufacturing and inspection in a homogeneous manner.

References:

- [1] 2009, ASME Y14.5-2009 Dimensioning and Tolerancing, ASME, New York, NY.
- [2] ISO 1101:2004 Geometrical Product Specifications (GPS) — Geometrical tolerancing — Tolerancing of form, orientation, location and run-out.
- [3] Shah J. J., Ameta G., Shen Z., and Davidson J., 2007, “Navigating the Tolerance Analysis Maze,” *Computer-Aided Design & Applications*, **4**(5), pp 705-714.
- [4] Shen Z., Ameta G., Shah J. J., and Davidson J. K., 2005, “A Comparative Study Of Tolerance Analysis Methods,” *Journal of Computing and Information Science in Engineering*, **5**(3), pp 247-256.
- [5] Chase K. W., and Parkinson A. R., 1991, “A survey of research in the application of tolerance analysis to the design of mechanical assemblies,” *Research in Engineering Design*, **3**(1), pp 23–37.
- [6] Hong Y. S., and Chang T. C., 2002, “A comprehensive review of tolerancing research,” *International Journal of Production Research*, **40**(11), pp 2425–2459.
- [7] Nigam S. D., and Turner J. U., 1995, “Review of statistical approaches to tolerance analysis,” *Computer-Aided Design*, **27**(1), pp 6–15.

- [8] Prisco U., and Giorleo G., 2002, "Overview of current CAT systems: Review Article," *Integrated Computer-Aided Engineering*, **9**(4), pp 373–387.
- [9] Davidson J. K., Mujiezinovic A., and Shah J. J., 2002, "A new mathematical model for geometric tolerances as applied to round faces," *Journal of Mechanical Design*, **124**(4), pp 609–622.
- [10] Marziale M., and Polini W., 2011, "A review of two models for tolerance analysis of an assembly: Jacobian and torsor," *International Journal of Computer Integrated Manufacturing*, **24**(1), pp 74–86.
- [11] Marziale M., and Polini W., 2009, "A review of two models for tolerance analysis of an assembly: vector loop and matrix," *The International Journal of Advanced Manufacturing Technology*, **43**(11), pp 1106–1123.
- [12] Hillyard R. C., and Braid I. C., 1978, "Analysis of dimensions and tolerances in computer-aided mechanical design," *Computer-Aided Design*, **10**(3), pp 161–166.
- [13] Gossard D. C., Zuffante R. P., and Sakurai H., 1988, "Representing dimensions, tolerances, and features in MCAE systems," *IEEE Computer Graphics and Applications*, **8**(2), pp 51–59.
- [14] Requicha A. A. G., and Chan S. C., 1986, "Representation of Geometric Features Tolerances, and Attributes in Solid Modelers Based on Constructive Geometry", *IEEE Journal of Robotics and Automation*, **2**(3), pp 156-166.
- [15] Requicha A. A. G., 1983, "Toward a theory of geometric tolerancing," *The International Journal of Robotics Research*, **2**(4), pp 45.
- [16] Roy U., and Liu C. R., 1988, "Feature-based representational scheme of a solid modeler for providing dimensioning and tolerancing information," *Robotics and Computer-Integrated Manufacturing*, **4**(3-4), pp 335–345.
- [17] Pasupathy T. M. K., Morse E. P., and Wilhelm R. G., 2003, "A survey of mathematical methods for the construction of geometric tolerance zones," *Journal of Computing and Information Science in Engineering*, **3**(1), pp 64-76.
- [18] Martinsen K., 1993, "Vectorial tolerancing for all types of surfaces," *ASME Advances in Design Automation*, ASME, **2**, pp 187–198, New York, NY(USA).
- [19] Turner J. U., and Wozny M. J., 1990, "The M-space theory of tolerances," *Proceedings of the ASME 16th Design Automation Conference*, pp 217-225, Chicago, IL.
- [20] Chase K. W., Gao J., Magleby S. P., and Sorenson C. D., 1996, "Including geometric feature variations in tolerance analysis of mechanical assemblies," *IIE transactions*, **28**(10), pp 795–808.
- [21] Rivest L., Fortin C., and Morel C., 1994, "Tolerancing a solid model with a kinematic formulation," *Computer-aided design*, **26**(6), pp 465–476.
- [22] Chase K. W., Gao J., and Magleby S. P., 1995, "General 2-D tolerance analysis of mechanical assemblies with small kinematic adjustments," *Journal of Design and Manufacturing*, **5**(4), pp 263–274.
- [23] Gao J., Chase K. W., and Magleby S. P., 1998, "Generalized 3-D tolerance analysis of mechanical assemblies with small kinematic adjustments," *IIE transactions*, **30**(4), pp 367–377.
- [24] Kramer G. A., 1992, *Solving geometric constraint systems: a case study in kinematics*, The MIT Press, Cambridge, MA.
- [25] Coxeter H. S. M., 1961, "Introduction to geometry," John Wiley, New York, NY.
- [26] Bhide S., Davidson J. K., and Shah J. J., 2003, "A new mathematical model for geometric tolerances as applied to axes," In: *CD Proceedings of ASME Design Engineering Technical Division, Design Automation Conference*, paper no. 48736.
- [27] Davidson J. K., and Shah J. J., 2002, "Geometric tolerances: a new application for line geometry and screws," *Proceedings of the Institution of Mechanical Engineers, Part C: Journal of Mechanical Engineering Science*, **216**(1), pp 95–103.

- [28] Ameta G., Davidson J. K., and Shah J. J., 2004, "The Effects of Different Specifications on the Tolerance-Maps for an Angled Face," Proceedings of ASME Design Engineering Technical Conferences – Design Automation Conference, Salt Lake City, Utah, Sept-Oct 04, paper no. 57199.
- [29] Jian A., Ameta G., Davidson J., and Shah J., 2007, "Tolerance analysis and allocation using tolerance-maps for a power saw assembly," In Models for Computer Aided Tolerancing in Design and Manufacturing, Eds. Davidson J. K., p. 267–276, Springer, Dordrecht, The Netherlands.
- [30] Ameta G., Davidson J. K., and Shah J. J., 2007, "Tolerance-Maps Applied to a Point-Line Cluster of Features," Journal of Mechanical Design, **129**, pp 782-792.
- [31] Mujezinović A., Davidson J. K., and Shah J. J., 2004, "A new mathematical model for geometric tolerances as applied to polygonal faces," Journal of Mechanical Design, **126**(3), p. 504-518.
- [32] Giordano M., Samper S., and Petit J., 2007, "Tolerance analysis and synthesis by means of deviation domains, axi-symmetric cases," In Models for Computer Aided Tolerancing in Design and Manufacturing, Eds. Davidson J. K., pp. 85–94, Springer, Dordrecht, The Netherlands.
- [33] Samper S., Petit J. P., and Giordano M., 2007, "Elastic Clearance Domain and Use Rate Concept Applications to Ball Bearings and Gears," In Models for Computer Aided Tolerancing in Design and Manufacturing, Eds. Davidson J. K., pp 331–340, Springer, Dordrecht, The Netherlands.
- [34] Samper S., Petit J. P., and Giordano M., 2006, "Computer Aided Tolerancing-solver and post processor analysis," In Advances in Design, Eds. Hoda ElMaraghy and Waguih ElMaraghy, p. 487–497, Springer, London.
- [35] Adragna P. A., Samper S., and Pillet M., 2010, "A proposition of 3D inertial tolerancing to consider the statistical combination of the location and orientation deviations," International Journal of Product Development, **10**(1), pp 26–45.
- [36] Adragna P. A., Samper S., and Favreliere H., 2010, "How Form Errors Impact on 2D Precision Assembly with Clearance?," In Precision Assembly Technologies and Systems, Eds. Svetan Ratchev, pp. 50–59, Springer, Berling, (Proceedings of 5th IFIP WG 5.5 International Precision Assembly Seminar, IPAS 2010, Chamonix, France, February 14-17, 2010).
- [37] Fukuda K., Petit J. P., and Annecy F., 2003, "Optimal tolerancing in mechanical design using polyhedral computational tools," Proceedings of the 19th European Workshop on Computational Geometry, pp. 117-120
- [38] Germain F., Giordano M., and Adragna P. A., 2006, "Taking manufacturing dispersions into account for assembly: modelling and simulation," Journal of Machine Engineering, **6**(1), pp. 83-94.
- [39] Reuleaux F., 1875, Theoretische Kinematik: Grundzüge einer Theorie des Maschinenwesens, F. Vieweg und Sohn.
- [40] Hunt K. H., 1976, "Geometry–The key to Mechanical movements," Mechanism and Machine Theory, **11**(2), pp 79–89.
- [41] Desrochers A., and Clement A., 1994, "A dimensioning and tolerancing assistance model for CAD/CAM systems," The International Journal of Advanced Manufacturing Technology, **9**(6) p p. 352–361.
- [42] Desrochers A., 2003, "A CAD/CAM representation model applied to tolerance transfer methods," Journal of Mechanical Design, **125**, pp 14-22.
- [43] Clément A., Rivière A., Serré P., and Valade C., 1997, "The TTRS: 13 constraints for dimensioning and tolerancing," Proc. of the 5th CIRP Int. Seminar on Computer-Aided Tolerancing.

- [44] Desrochers A., 1999, "Modeling three dimensional tolerance zones using screw parameters," CD-ROM Proceedings of ASME 25th Design Automation Conference, DAC-8587, Las-Vegas, NV.
- [45] Laperrière L., and Desrochers A., 2002, "Modeling assembly quality requirements using Jacobian or screw transforms: a comparison," Proceedings of the IEEE International Symposium on Assembly and Task Planning, pp 330–336.
- [46] Clément A., Rivière A., And Serré P., 1996, "The TTRS: a Common Declarative Model for Relative Positioning, Tolerancing and Assembly", MICAD proceedings," *Revue de CAD-CAM et d'informatique graphique*, 1(1-2), pp 149–164.
- [47] Liu J., and Wilhem R., 2001, "Genetic Algorithms for TTRS Tolerance Analysis," Proceedings of the 7th CIRP International Seminar on Computer Aided Tolerancing, Paris, France, p. 55–64.
- [48] Ameta G., Davidson J. K., and Shah J. J., 2007, "Using Tolerance-Maps to Generate Frequency Distributions of Clearance and Allocate Tolerances for Pin-Hole Assemblies," *Journal of Computing and Information Science in Engineering*, 7(4), p. 347-359.
- [49] Ameta G., 2006, "Statistical tolerance analysis and allocation for assemblies using Tolerance-Maps," Ph. D. Dissertation, Arizona State University.
- [50] Ameta G., Davidson J. K., and Shah J., 2010, "Influence of form on Tolerance-Map-generated frequency distributions for 1D clearance in design," *Precision Engineering*, 34(1), pp 22–27.
- [51] Ameta G., Davidson J. K., and Shah J. J., 2010, "Statistical Tolerance Allocation for Tab-Slot Assemblies Utilizing Tolerance-Maps," *Journal of Computing and Information Science in Engineering*, 10(1).
- [52] Singh G., Ameta G., Davidson J. K., and Shah J. J., 2009, "Worst-Case Tolerance Analysis of a Self-Aligning Coupling Assembly using Tolerance-Maps," Proc., 11th CIRP Int'l Seminar, Annecy, France.
- [53] Nejad M. K., Vignat F., Desrochers A., and Villeneuve F., 2010, "3D Simulation of Manufacturing Defects for Tolerance Analysis," *Journal of Computing and Information Science in Engineering*, 10(2).
- [54] Villeneuve F., and Vignat F., 2005, "Manufacturing process simulation for tolerance analysis and synthesis," In *Advances in Integrated Design and Manufacturing in Mechanical Engineering*, pp 189–200, Eds. Alan Bramley, Daniel Brissaud, Daniel Coutellier and Chris McMahon, Springer, Dordrecht, The Netherlands.
- [55] Jayaprakash G., Sivakumar K., and Thilak M., 2010, "Parametric Tolerance Analysis of Mechanical Assembly by Developing Direct Constraint Model in CAD and Cost Competent Tolerance Synthesis," *Intelligent Control and Automation*, 1(1), pp 1–14.
- [56] Jaballi K., Bellacicco A., Louati J., Riviere A., and Haddar M., 2011, "Rational method for 3D manufacturing tolerancing synthesis based on the TTRS approach," *Computers in Industry*.
- [57] Stuppy J., and Meerkamm H., 2009, "Tolerance Analysis of Mechanisms Taking into Account Joints with Clearance and Elastic Deformations," Proceedings of the 17th International Conference on Engineering Design (ICED'09), Vol. 5, pp 489–500.