



HAL
open science

Modelling and Simulation of the Pumping in a Former Mine Using Sequential Automata; Coal Mine of Rochebelle - St-Martin de Valgalgues, Cévennes, France

Stéphanie Gairoard, Anne-Lise Courbis, Bernard Vayssade

► **To cite this version:**

Stéphanie Gairoard, Anne-Lise Courbis, Bernard Vayssade. Modelling and Simulation of the Pumping in a Former Mine Using Sequential Automata; Coal Mine of Rochebelle - St-Martin de Valgalgues, Cévennes, France. 10th International Mine Water Association Congress, 2012, Carlsbad, Czech Republic. 9 p. hal-00799564

HAL Id: hal-00799564

<https://hal.science/hal-00799564>

Submitted on 12 Mar 2013

HAL is a multi-disciplinary open access archive for the deposit and dissemination of scientific research documents, whether they are published or not. The documents may come from teaching and research institutions in France or abroad, or from public or private research centers.

L'archive ouverte pluridisciplinaire **HAL**, est destinée au dépôt et à la diffusion de documents scientifiques de niveau recherche, publiés ou non, émanant des établissements d'enseignement et de recherche français ou étrangers, des laboratoires publics ou privés.

Modelling and Simulation of the Pumping in a Former Mine Using Sequential Automata; Coal Mine of Rochebelle - St-Martin de Valgalgues, Cévennes, France

Gairoard S.^{a)}, Courbis A-L.^{b)}, Vayssade B.^{a)}

^{a)} CMGD - Ecole des Mines d'Alès, 6 Avenue de Clavières 30319 Alès cedex, France.

E-mail : stephanie.gairoard@ema.fr; bernard.vayssade@ema.fr

^{b)} LGI2P - Ecole des Mines d'Alès, 69 rue Georges Besse 30000 Nîmes, France.

E-mail : Anne-Lise.Courbis@ema.fr

Abstract

We are interested in evaluating the effect of a pumping in an aquifer influenced by former mines from a quantitative aspect. For this purpose, we have developed a simulation tool allowing the piezometric level to be evaluated in a realistic way, having at disposal the following data: the geometry of the reservoir, information concerning the surface (landcover), the precipitations and the daily volume of pumped water. We will explain the method used to set up the model and present first results obtained in former coal mine of Rochebelle - St-Martin de Valgalgues located Cévennes, South of France.

Key words: Modelling mining aquifer, flow of pumping, former coal mine, discrete event modelling of catchment, hydrogeology, Cévennes.

Introduction

In the region around the city of Alès (southern France), coal has been exploited since the 13th century. At present, all the coal mines are closed, mines galleries are flooded and the water must be pumped in order to be treated before going to the river. This has led to monitor the quality and the quantity of this groundwater outflow. During underground mining operations, the creation of galleries and shafts tends to modify the permeability into large solid masses. The closing of mining operations is followed by stopping water pumping and raising the piezometric level. This increase in piezometric level takes place within an environment modified by anthropogenic activities over time. Water quality in the region is being monitored.

This work will focus on mine water and more particularly to a mining reservoir near Alès (Rochebelle). In the former exploitation of Rochebelle - St Martin de Valgalgues, pumping was maintained to redirect water to a treatment plant.

To understand the functioning of the mining reservoir in terms of flow and the parameters that define it, we propose to use a simulation approach. When the system is well defined, it will be easier to anticipate by simulation any consequence of a change in the management of the aquifer (in case of stopping the pumping, for example; amount of water available to use this reserve ...). For this reason, we have developed a simulation tool supported by a modelling methodology based on discrete event theory. The purpose of the simulator is to reconstitute the real piezometric level of the mining aquifer fluctuating; several parameters are used permeability, infiltration, available storage of the soil, storage of the aquifer.

The paper is organised into 4 parts. The first part presents the characteristics of the region under study from geological and land-use points of view. We will then present what are phenomena involved in water balance estimation and in groundwater pumping such as their mathematical representation and then, the modelling approach and the simulation software developed for this study are presented. Last part is about the simulation parameters and results obtained on the region under study. Finally, we will present our future work in order to improve the results.

Vegetative and geological description

The mining aquifer Rochebelle St Martin- developed in primary level that has been exploited for the coal extraction. The geological nature of layer that covers the reservoir varies geographically.

Figure 1 Geology above the mining reservoir (with Geological map : Berger et al, 1978)

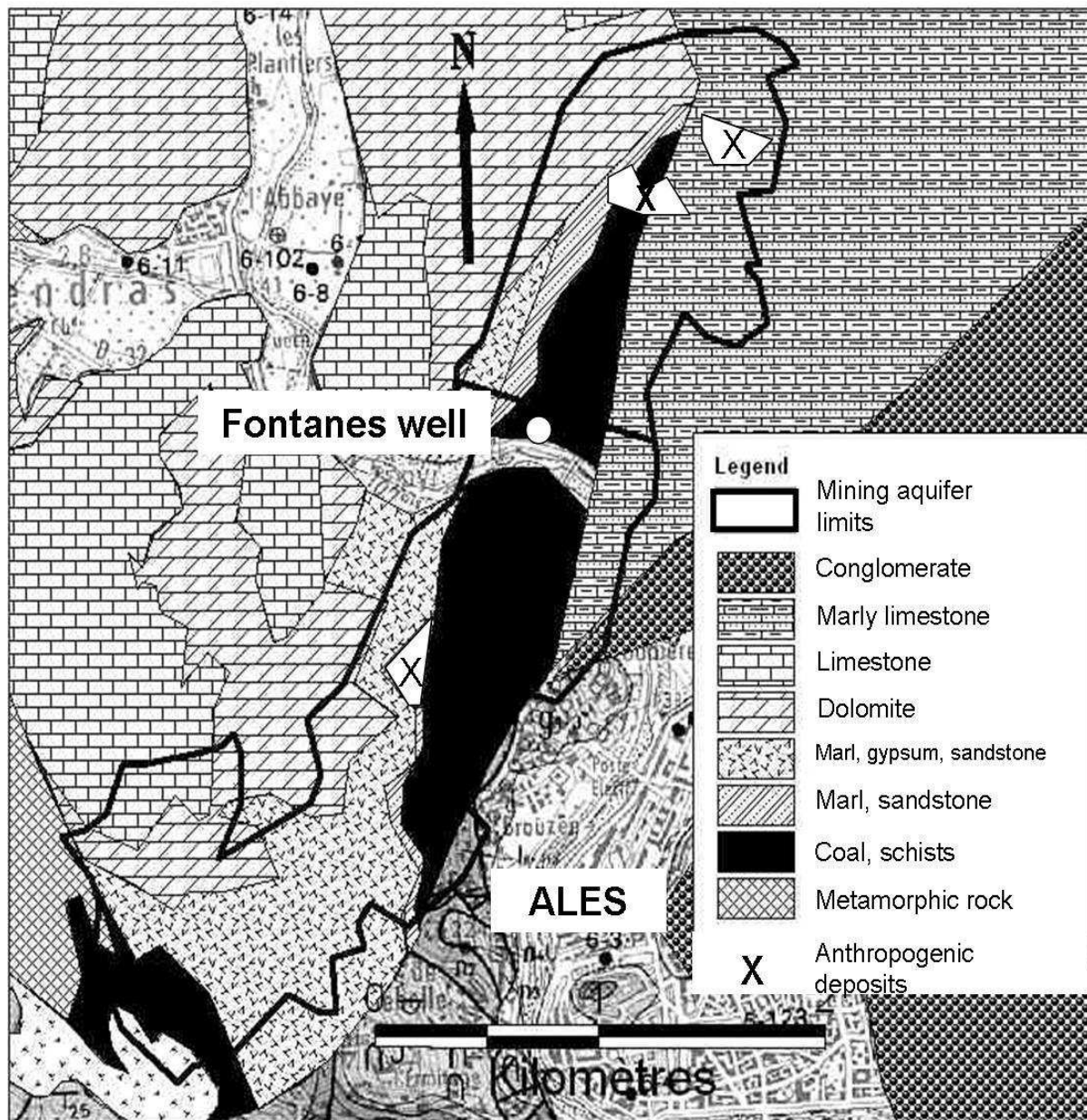

The extension of this reservoir is 4.36 km² and it is limited by faults supposed impervious. The vegetation is varied on the surface overlying the mining aquifer. This diversity will influence potential evapotranspiration and water infiltration into the aquifer (see *Figure 2*).

Figure 2 Vegetative cover of mining aquifer (Fontanes, France)

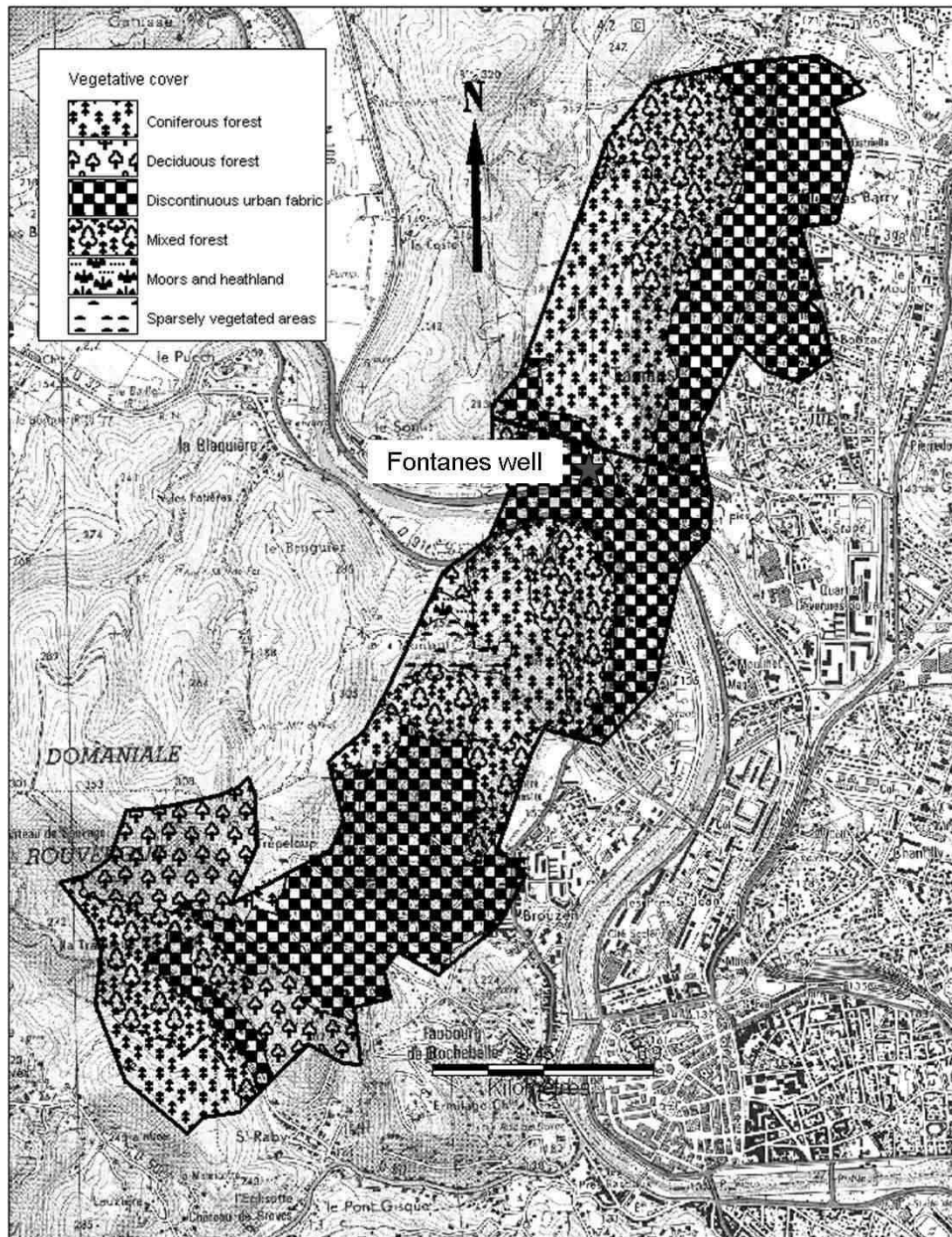

The water of this reservoir is pumped at a well named Fontanes. It is located approximately in the middle of the aquifer. The volume of the reservoir is estimated at 18 000 000 m³ (CESAME Research Department).

Phenomena to be modelled

The first step to be considered before modelling the pumping is to set up the water balance of the area under study. The water balance takes into account phenomena occurring at the soil level: evapotranspiration, surface runoff, sub-surface runoff, infiltration and those of the saturated area (see Figure 3).

Figure 3 Hydrological surface and underground phenomena involved in water balance (Courbis et al., 2007)

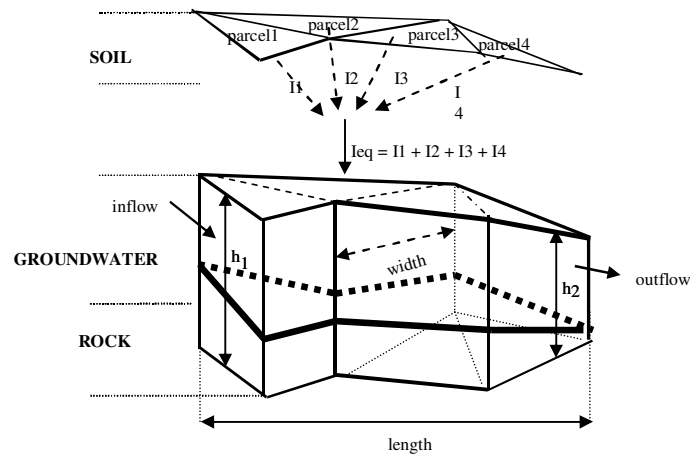

Let us consider a part of the area, called in the following *parcel*, determined in such a way that its landcover is homogeneous as well as its slope. Figure 4 gives in details all phenomena involved in the water balance of a parcel. The evapotranspiration can be evaluated according to several approaches; for the purpose of our study, we have chosen the Thornthwaite method. Let us note MaxWS, the maximum water storage of the soil. The relationships between phenomena have been modelled as follows:

- (1) $DSR = \alpha \cdot (P + USSR)$ where α is the runoff rate and depends on landcover
- (2) $Eta = \text{Thornthwaite}(t, WS)$ where t is the temperature and WS the water storage. Let us note Eta modify WS if there is not enough precipitation. Let us note WS^* the new value of WS after Eta computation.
- (3) $availableStorage = WS^* + USSR + (P - DSR - Eta)$
- (4) $WS = \text{Min}(availableStorage, MaxWS)$ and
- (5) $efficientRain = availableStorage - MaxWS$, if $(availableStorage > MaxWS)$, else 0.
- (6) $DSSR = (1 - \beta) \cdot efficientRain$ where β is the infiltration rate
- (7) $I = \beta \cdot extraWS$

Figure 4 : Basic phenomena involved in water balance at the soil level (Courbis et al., 2007)

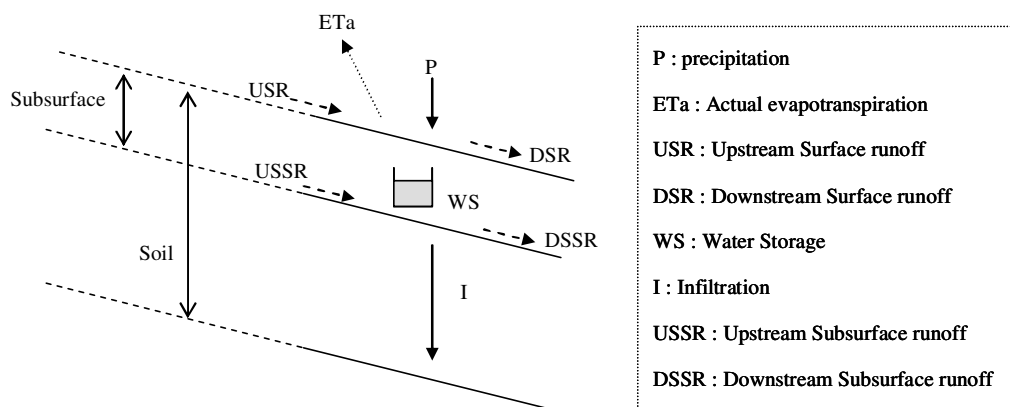

Each parcel infiltration contributes to the groundwater recharge and the groundwater body can be viewed as a uniform hydrogeologic item (see Figure 3). In our study, we have considered that the

catchment rock under the former mines is homogeneous, non fissured and impervious. Consequently, there is no water loss in the rock substratum.

Let us now consider the effect of pumping on the groundwater body. It can be modelled by Theis and Jacob equations (Freeze, 1979):

During the pumping :

$$(8) s(r) = \frac{Q}{4\pi T} \left(-0.5772 - 2.3 \log(U) + U - \frac{U^2}{4} + \frac{U^3}{18} \right)$$

with: $U = \frac{r^2 S}{4Tt}$

s: drawdown in m, measured in a piezometer

r : distance r (in m) of pumping well.

Q: maintainable yield of pump, m³ /day

S: storage coefficient, dimensionless

T: aquifer transmissivity, m²/day

t: time in days since the beginning of pumping

For days, when the pumping was stopped in the mining reservoir:

$$(9) s = \frac{2.3 Q}{4\pi T} \log\left(\frac{2.25T(t_a + t')}{r^2 S}\right) - \frac{2.3 Q}{4\pi T} \log\left(\frac{2.25Tt'}{r^2 S}\right)$$

t_a: time elapsed since the origin of pumping up its stop, day

t': time measured after that stop, day

Q: flow that created the initial drawdown, m³ /day

r : distance from the well to the piezometer

Let us consider h₁ (resp. h₂) the initial piezometer level of the groundwater body (see figure 1) at a point located far from the well (resp. near the well) and r₁ (resp. r₂) the distance of the piezometer from the pumping well. The outflow is evaluated according to the Darcy's law as follows :

$$(10) \text{outflow} = \frac{k \cdot (h_1 - s(r_1) - h_2 + s(r_2))}{(r_1 - r_2)} \cdot \pi \cdot r_2 \cdot (h_2 - s(r_2))$$

Having defined the mathematical formalisation of phenomena involved in the water balance of a parcel, in the pumping and in the groundwater body, we present in the following how it has been implemented at a catchment scale.

Modelling and simulation tool

We have developed a C++ software allowing the model of the area under study to be automatically set up from a data base describing parcels of the area and its groundwater body. Data describing parcels are: surface, landcover, dominated parcels for computing runoff, available storage and infiltration rate. Data describing the groundwater body are: width, length, thickness, piezometric levels at its boundaries, transmissivity and storage coefficient.

The model is dynamically built up according to object oriented paradigms and discrete event theory proposed by Ziegler (1984). Any basic behaviour corresponding to a basic phenomenon presented in the previous paragraph is implemented by a class that derives from a sequential automata class i.e. an object allowing output to be computed from input, an internal state and the life duration of the state. This approach allows the temporal granularity to be modified (daily, monthly or decade) without modifying neither the model, nor the simulator. The discrete event simulation aims at computing the

state changes and the output produced by all automata at a discrete period. By this way, the calculus is simple while the period of computation can easily be modified.

The model is built up by a hierarchical approach: at the first step of modelling, sequential automata are interconnected in order to represent the water balance of a parcel (see Figure 5-a). The next step consists in interconnecting parcel models in order to represent the water balance at a slope scale (see Figure 5-b). The connections are dynamically determined according to dominant relationships between parcels. For example, in Figure 5-b, the slope is constituted with three parcels and *parcel1* dominates *parcel2*, i.e. runoff of *parcel1* is going to *parcel2*. The catchment can be decomposed into 2 or 3 slopes, depending on its configuration. Last step of the modelling process is to connect slope models with groundwater body model, including the pumping, and river model in order to represent the whole catchment (see Figure 5-c).

Figure 5 Main steps to set up a model (a) parcel modelling (b) slope modelling (c) catchment modelling

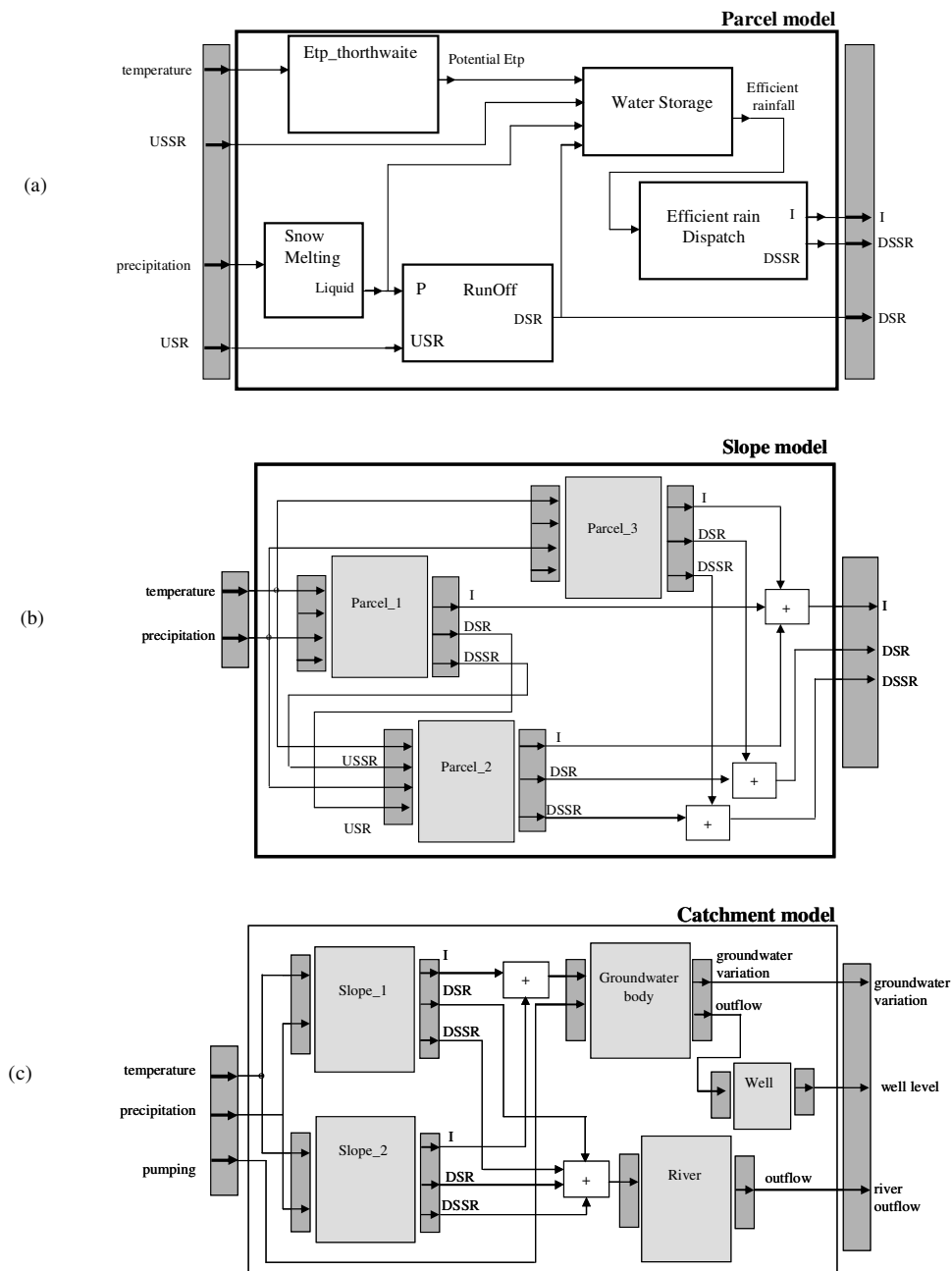

The model is thus ready to be simulated. The simulator is composed with a scheduler representing a set of time ordered events and an engine allowing events to be propagated and sequential automata to be activated. Input events of the model are daily climatic data (precipitation and temperature) and daily pumping measures. Results are stored in a excel file and consists of daily outflow of the river, daily groundwater and well variations.

Simulation of the studied catchment

The purpose of this model is to reproduce the piezometric levels of the mining reservoir which is studied. The originality comes from the incorporation of the effect of pumping still operating and environmental parameters that have an influence on the level of the mining aquifer: soil coverage, geological nature of the parcels, precipitations.

When the simulator is built, some parameters defining the mining system will have to be adjusted to get a good result approaching the reality.

The parameters of the mining reservoir that we have to adjust are:

- The piezometric levels at pumping well and extremities of the aquifer.
- The permeability of the aquifer
- The thickness of the aquifer
- The storage

The surface parameters to be set up are :

- The amount of water that will infiltrate into the groundwater
- The influence of vegetation on surface runoff and the distribution between subsurface runoff and infiltration
- The available storage

The simulator is operating at daily time step. The daily weather data (temperature and precipitation) are processed as input of the simulator, affecting the amount of water infiltrating into the groundwater and evapotranspiration. These data come from a weather station near Alès (at 10 km from Fontanes) At the same daily step time, flow pumping is applied on the mining reservoir letting fluctuate the piezometric level.

Simulation on the year 1997

Pumping and precipitations, for the year 1997, are represented on Figure 6. On average in the region, rainfall may reach 1000 mm / year and are strongly influenced by the 'cévenols' events. The total rain for 1997 to Salindres (Gard) at 10 km from Fontanes, reached 1324.9 mm; it is a rainier year than the average but still representative. We observe a rainfall peak (300 mm) in October corresponding to 'cévenols' events and the rainiest months, of this year, are January, June, November and December with 160 mm / month on average.

Figure 6 Pumping and precipitations in 1997

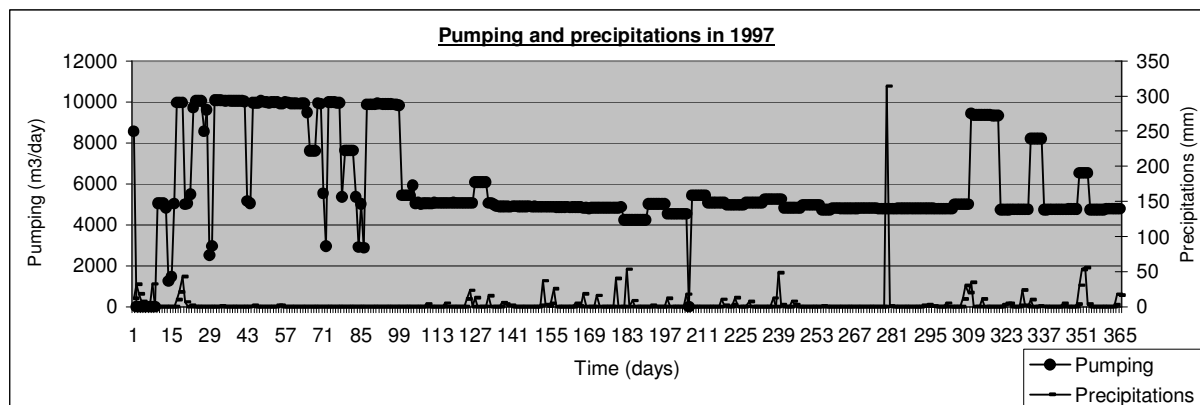

The piezometric levels of southern part of aquifer are known by measures at Fontanes well and St-Raby piezometer close to the south limit; the northern part of aquifer has a level which is known only at Fontanes well. We consider that the maximum piezometric level of the northern part of aquifer is higher than the southern part of aquifer, given by the geometry of the system. The Northern part of aquifer (1.52 km²) is of smaller extent than the southern part of aquifer (2.84 km²), and the permeability is higher in the Northern part. The thickness of the water is 200m. As the inflow of year-end 1996 is not reflected in the simulator, we adjust this oversight by increasing the piezometric level base.

Figure 7 Measured and simulated levels in Fontanes well

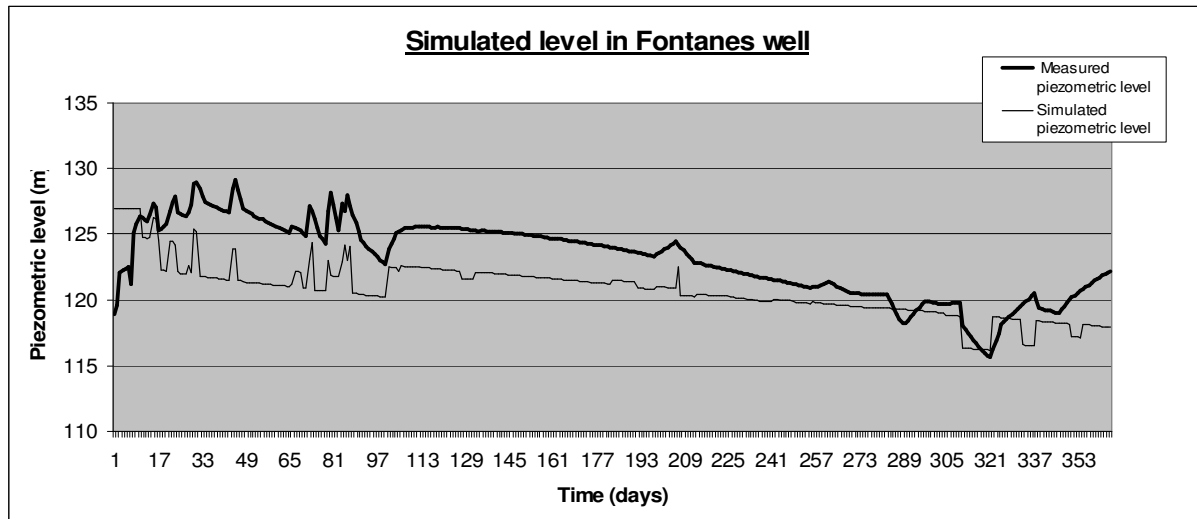

For the North limit of the aquifer, piezometric level, in the simulator is 140 m and for South limit, the value is 128 m.

The parameters that have been fixed for the simulation are given in the following table, taking into account the knowledge we have about the area under study.

Parameters	Aquifer
Permeability(m/s) in average	$3.8 \cdot 10^{-4}$
Storage	$5 \cdot 10^{-2}$
Thickness (m)	200
Infiltration rate (dimensionless)	0.9
Available storage (mm)	200

The simulated curve (see

Figure 7) reproduces correctly and synchronously the phenomena occurring in the aquifer, including pumping. To take account of precipitation occurring at the end of 1996, we decided to increase slightly the minimum piezometric level of the aquifer. The decrease in the piezometric level is well represented, however, the inflow of water are still underestimated (simulated curve is below the true curve). We do not yet obtain rise in the piezometric level after rainfall or pumping. Decrease and increase are abrupt and must be refined.

Conclusion

The simulation tool shows its ability to describe the variation of water level in a zone strongly affected by mining. Nevertheless, this simulation tool also shows that it cannot give realistic results when the water level rises mainly in autumn. This indicates that our hypothesis concerning the inflow of water is too restrictive. First of all, we supposed that the faults limiting our system are strictly impervious. These results from simulations lead to ask for more information on this point. The lack of data

concerning the water level in the North part also led us to make some hypothesis about the northern limit of the pervious zone. More investigation on this point is needed. On the other hand different simulations indicated that the influence of the land-cover is of second order on the water level. So this simulation tool appears to be a good mean to indicate the factors the knowledge of which should be improved.

Acknowledgments

The authors would like to thank the *Charbonnages de France* organisation as well as the CESAME Research Department for their collaboration, Géoderis and MétéoFrance.

References

- Berger G., Lefebvre A., Turc R., Gras H., Poidevin J-L., Arene J., Guerange B., (1978) – carte géologique France (1/50 000), feuille Alès (912) – Orléans : Bureau de recherches géologiques et minières. Notice explicative par ARENE J., BERGER G.-M., GRAS H., POIDEVIN J.L., SAUVEL C., (1978), 57 p
- Courbis A.L, Vayssade B., (2007) Simulation as a decision-support for evaluating effects of anthropogenic activities on water resources, 10th International Conference on Environmental Science and Technology (CEST 2007) Kos, Grèce, 4-8 septembre 2007, pp 267-274.
- Freeze R A., Cherry J A., (1979) Groundwater - Englewood Cliffs, 604 p.
- Ziegler B.P., (1984) Multifaceted modeling and discrete event simulation, Academic Press