



HAL
open science

Modeling of Hydro-Pneumatic Energy Storage Using Pump Turbines

Egoï Ortego, Antoine Dazin, Guy Caignaert, Frédéric Colas, Olivier Coutier-Delgosha

► **To cite this version:**

Egoï Ortego, Antoine Dazin, Guy Caignaert, Frédéric Colas, Olivier Coutier-Delgosha. Modeling of Hydro-Pneumatic Energy Storage Using Pump Turbines. Pumped storage Powerplants, Nov 2011, France. pp.8. hal-00797870

HAL Id: hal-00797870

<https://hal.science/hal-00797870v1>

Submitted on 7 Mar 2013

HAL is a multi-disciplinary open access archive for the deposit and dissemination of scientific research documents, whether they are published or not. The documents may come from teaching and research institutions in France or abroad, or from public or private research centers.

L'archive ouverte pluridisciplinaire **HAL**, est destinée au dépôt et à la diffusion de documents scientifiques de niveau recherche, publiés ou non, émanant des établissements d'enseignement et de recherche français ou étrangers, des laboratoires publics ou privés.

MODELING OF HYDRO-PNEUMATIC ENERGY STORAGE USING PUMP TURBINES

Egoï Ortego ⁽¹⁾, Antoine Dazin ⁽¹⁾, Guy Caignaert ⁽¹⁾, Frédéric Colas ⁽²⁾,

Olivier Coutier-Delgosha ⁽¹⁾

Arts et Métiers ParisTech

⁽¹⁾ Laboratoire de Mécanique de Lille

UMR CNRS 8107

⁽²⁾ L2EP

8, Boulevard Louis XIV, 59046 Lille Cedex, France

Keywords

Hydro-pneumatic energy storage, pump turbine, compressed air

Résumé

On présente ici la modélisation d'un système hydro-pneumatique de stockage d'énergie. Ce type de stockage permet de combiner le bon rendement de la conversion hydraulique d'énergie et la flexibilité spatiale du stockage pneumatique. L'objectif du projet est de modéliser un prototype utilisant une pompe/turbine rotodynamique qui déplace un piston liquide virtuel pour comprimer de l'air. L'absence de séparation entre les deux phases devrait faciliter les échanges de masse et de chaleur.

Un model dynamique est développé utilisant une méthode de diagrammes fonctionnels. On utilise les courbes caractéristiques de la pompe turbine et des équations de la thermodynamique. Les résultats de simulation confirment que la diffusion de vapeur d'eau dans l'air provoque une certaine diminution de la température de fin de compression. Ceci se traduit par une augmentation du rendement de stockage.

La construction d'un banc d'essai va débiter à la fin de l'automne 2011. Celui-ci sera connecté à la plateforme d'énergies réparties des Arts et Métiers ParisTech de Lille.

Abstract

Modelling of a hydro-pneumatic energy storage system is presented in this paper. Hydro-pneumatic storage aims to combine the good efficiency of hydraulic energy conversion and the space flexibility of pneumatic storage. The project aims to model a prototype which uses a rotodynamic multi-stage pump-turbine to displace a virtual liquid piston to compress air. To facilitate mass and heat transfers between both phases, there is no separation between the water and the air.

A dynamic model of the storage system is developed using block diagram methodology. It takes into account characteristic curves of the pump-turbine and thermodynamic equations. Modelling results show that vapour diffusion contributes to reducing compression final temperature. This implies an increase of storage efficiency.

A test rig construction will begin at the end of autumn 2011. It will be electrically connected to the "Distributed Energies" platform of "Arts et Métiers Paristech" in Lille.

I Introduction

The intermittent character of some renewable energies (i.e. solar PV and wind), and potential introduction of electrical vehicle are part of future issues for electrical network managers; one of the considered solutions to improve energy flows management is the energy storage.

Currently, large hydraulic pumped storage is a widely used solution, but many other chemical, mechanical, thermal, pneumatic or electrical technologies are in development or in use. Different purposes call for different technologies which can be classified in terms of delivered power and energy capacity. Hydraulic storage or compressed air energy storage (CAES) can be used in energy applications like peak shaving (i.e. equilibrium between day and night consumption). Flywheels or super capacitors are more often used for power application (ex: flicker compensation) [1].

Pumped hydro is interesting because of the stored energy amount and the deliverable power; the drawback is the need of natural sites for water accumulation. CAES can be spatially flexible but has relatively low conversion efficiency. Hydro-pneumatic energy storage (HYPES) can combine the both. It is based on air compression storage using hydraulics, which allows relatively high conversion efficiencies and high power densities. The basic idea is to compress air in a closed vessel by means of a liquid piston during storage phase and use this potential energy when needed (fig. 1).

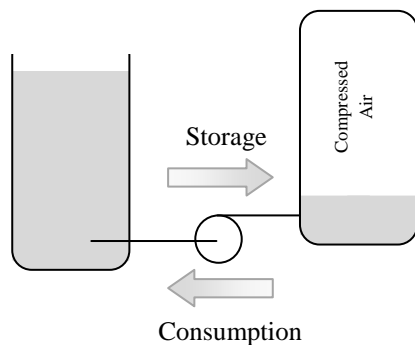

Figure 1: Storage/consumption process

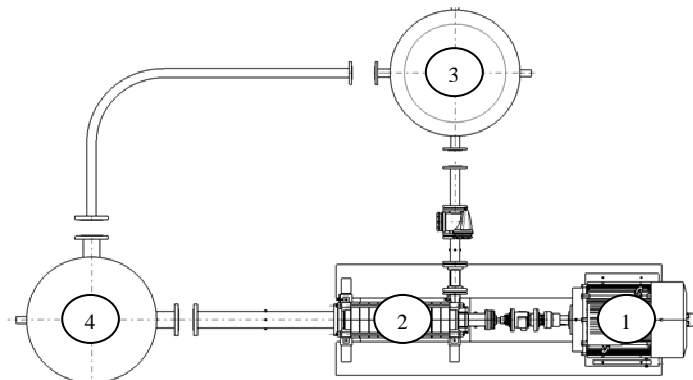

Figure 2: Test rig: 1-Siemens bipolar 70kW electric motor, 2-KSB Multitec A50/12A pump/turbine, 3-Hight pressure vessel, 4-Low pressure vessel

Thus, HYPES was developed in some laboratories like in Switzerland [2] and USA [3, 4]. Structures proposed by these teams use closed or open gas cycles, i.e. single compression and storage volume (fig. 1) or separated compression and storage volumes implying compressed air displacement into separated storage vessels. Another aspect in these works is the use of a physical separation between air and the compressing liquid piston. One of the objectives for these works was to be close to an isothermal cycle in order to obtain relatively high storage efficiencies.

Our project aims to analyze the possibility of using a rotodynamic pump turbine to drive the liquid and estimate the advantages of a closed cycle using no separation between the air and the water; this will facilitate heat and mass transfers, maintaining relatively low temperature variations.

Future test rig (fig.2) will be composed by a high pressure steel vessel (40 bars), a low pressure vessel, a multistage rotodynamic pump-turbine and an electric motor.

This paper presents models for simulation of HYPES dynamic behaviour, possible driving strategies of the storage system and some simulation results.

II Modelling

Models of storage devices are used for the dynamic simulation of the interactions between the storage devices and the electrical network. In this way the aim is to analyze the global power transmission of the HYPES system from pneumatics to mechanics. This includes a model for compressed air vessel and for the pump/turbine. The first takes in account compression/expansion work, thermal flows and mass flows (vapour in air and air in water). Models used for mechanical transmission and pipes are not presented here.

II.1 Vessel modelling

II.1.1 General equations

The energy is stored in a metallic high pressure vessel. Energy accumulation is done by the increase of the air pressure produced as the liquid piston moves. The air is interacting with its environment i.e. vessel wall (heat flux due to temperature variations) and water (heat and mass transfer). There are potentially strong interactions between air and water; compressed volume cannot be considered as dry air. This wet air is considered as a closed volume and the energy equation is written as follows:

$$dU = \delta Q - P_T dV \quad 1$$

This equation shows the variation of internal energy caused by the heat flux (δQ) and the mechanical work ($-P_T dV$) obtained from the pressure and the volume variation of the compression space.

The internal energy variation is written for both the air and the vapour masses inside the vessel:

$$dU = m_{air} \cdot C_{v,air} \cdot dT + m_{vap} \cdot C_{v,vap} \cdot dT \quad 2$$

The energy equation is then integrated on time to obtain the temperature variation produced by the volume variation. The partial pressures of air and vapour are deduced from ideal gas law:

$$P_i \cdot V = m_i \cdot R S_i \cdot T \quad 3$$

II.1.2 Thermal aspects

The air exchanges heat by convection with external air and water (radiation is not taken into account in this paper).

In free surface exchange mechanisms, heat and mass transfers are strongly coupled. Evaporation is possible for water molecules near the interface; the energy required to sustain the evaporation is given from air by convection and is approximated to the sensible and latent energy of water. Energy flows caused by air diffusion in water are neglected here.

Overall heat exchange problem is summarised in figure 2.

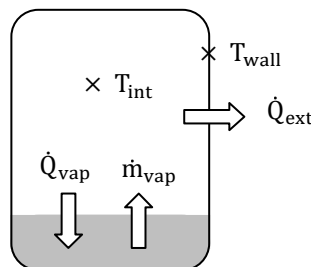

Figure 2: Fluxes on compressed volume

Here the steel vessel's wall conductive resistance is neglected (biot number $< 0, 01$). Thus, the total heat loss of air in stationary regime is:

$$\delta Q = \dot{Q}_{ext} + \dot{Q}_{vap} \quad 4$$

$$\dot{Q}_{ext} = -h_{int_air_wall} \cdot S \cdot (T_{int} - T_{wall}) \quad 5$$

$$\dot{Q}_{vap} = -\dot{m}_{vap} \cdot C_{p_water} \cdot (T_{int} - T_{water}) - \dot{m}_{vap} \cdot dH(T_{int}) \quad 6$$

The evaporated vapour mass flux is \dot{m}_{vap} , C_{p_water} is water's heat capacity and dH is the latent heat of vaporization for water. Internal and external convective heat exchange coefficients are obtained from literature [5, 6].

II.1.3 Mass transfer aspects

The wet air inside the vessel is submitted to various evolutions. The relative humidity (RH) of air is a function of temperature, and vapour concentration (see Figure 3).

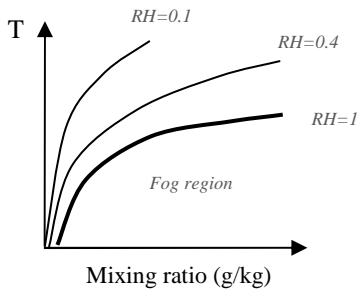

Figure 3: Mollier diagram for wet air

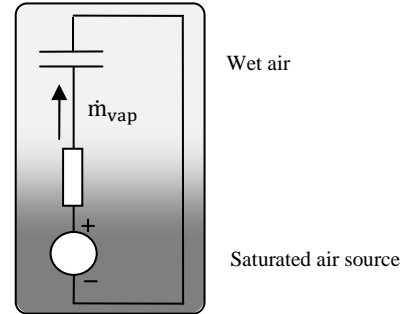

Figure 4: Water vapour diffusion-electrical analogy

Near the water free surface, a vapour saturated air thin film takes the role of humidity source. Vapour density difference between this and the air above is at the origin of the vapour diffusion: a water vapour mass flux is produced. A similar case occurs for air since the air partial pressure balance will produce an air mass flux through the air-water interface.

These diffusion mechanisms can be modelled by RC circuits (fig.4): the potentials at the origin of the fluxes are the concentration differences (or partial pressure differences). The concentration source is a sheet of saturated air, in contact with water, assumed to be able to deliver the necessary vapour mass flux. The resistance to the diffusive flux (R_{a-b}) is the inverse of the convective mass diffusion coefficient; which is quite difficult to estimate. This is function of the velocity field and turbulent state above the water. It will be evaluated by CFD calculation and validated by experimental results. The general expression of diffusive resistance is according to [7]:

$$R_{a-b} = -\frac{L}{Sh \cdot D_{a-b}} \quad 9$$

This expression contains a characteristic length of the volume, the Sherwood number and the diffusivity coefficient. In this expression, the Sherwood number is the unknown. This one is analogue to the Nusselt number for thermal convective transfers [7].

The corresponding mass flux in the case of the vapour is:

$$\dot{m}_{vap} = dm_{vap} = -\frac{S_{ab}}{R_{vapour-air}} \cdot (\rho_{vint} - \rho_{vmax}) \quad 10$$

The maximal water density is a function of the saturation partial pressure of the vapour in the air which depends on the temperature.

$$\rho_{v_max} = \frac{P_{vap}}{R_{s_vap}.T} = \frac{P_{sat}}{R_{s_vap}.T} \quad 11$$

$$P_{sat} = P_0 \cdot \exp\left(\frac{M_{eau}}{R} \cdot L_v(T) \cdot \left(\frac{1}{T_0} - \frac{1}{T}\right)\right) \quad 12$$

The internal water concentration is function of the amount of water vaporized into the compression volume, so it depends on the historic of the vapour flux and available volume:

$$\rho_{v_int} = \frac{m_{vap}}{V} = \frac{HR.P_{sat}.V.M_{vap}}{V.R.T} = \frac{1}{V} \cdot \int_{t1}^{t2} dm_{vap} dt \quad 13$$

Similar assumptions can be made for the air mass flux. In this case, the maximal concentration is calculated with the highest value of the solvability coefficient using Henry's constants of air components' dissolution in water; these are obtained from [8].

$$\rho_{i_max} = \frac{1}{V_{water}} \cdot x_{i/water} \cdot \frac{m_{water}}{M_{water}} \cdot M_i \quad 14$$

$$x_{i/water} = \frac{P_i}{k_{H,i}} \quad 15$$

Resistive model of air mass transfer is analogue to the one shown on fig. 4.

II.2 Pump/turbine

One of the particularities of this project is the use of a rotodynamic pump-turbine. This is a commercial model, and operating characteristics are given by the manufacturer. Characteristics for the whole operating range are obtained with the use of dimensionless parameters:

$$\delta = \frac{qV}{r^3 \cdot \omega}$$

$$\psi = \frac{dP}{\rho_{water} \cdot r^2 \cdot \omega^2}$$

$$\tau = \frac{Pu_{meca}}{\rho_{water} \cdot r^5 \cdot \omega^3}$$

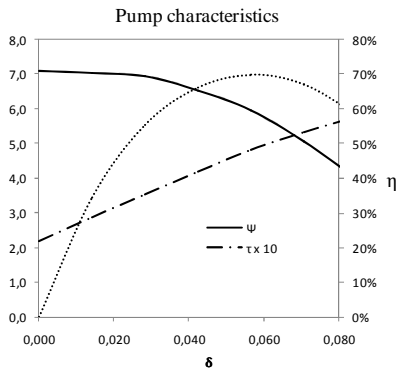

Figure 5

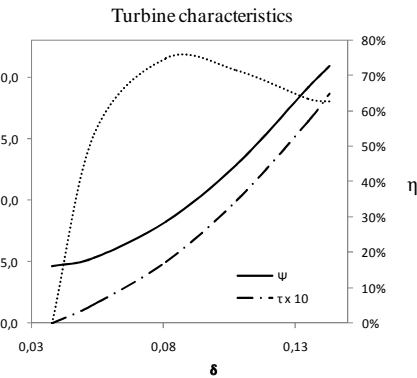

Figure 6

Here is shown the dependence of conversion efficiency on operating point i.e. pressure, water flow rate and angular speed. Since the pump/turbine is a multistage radial one, the pressure coefficient is quite high whereas the flow coefficient is relatively low. These are the steady operating characteristics, and one of the objectives of experimental phase will be to validate these curves for dynamic operating conditions or to introduce a full dynamic model of the device [9]. Beside, the characteristics presented in fig.5-6 are used for the simulation whatever the angular speed is. The Reynolds number effects are thus neglected.

III Simulation

The simulation of the HYPES system has been done for the basic configuration of the test rig, i.e. using KSB pump/turbine's curves and 1 m³ storage vessel model. Previous equations were implemented in form of block diagrams using Simulink environment. The pump/turbine's angular speed is controlled by the driving strategy presented below.

III.1 Driving strategy of the pump-turbine

During the energy storage and recovery phases, the available and necessary electrical power will certainly be variable. If the available power is enough during the entire compression period, the best efficiency point (BEP) strategy will be chosen; this is function of electric-hydraulic conversion efficiency and storage efficiency. If the consumer accepts to consume the whole range of the deliverable power, the BEP strategy can also be used during the expansion. The other solution is to take into account the really available and needed power. In this case, the conversion efficiency couldn't be maintained; this possibility is not presented here.

The efficiency of the pump-turbine depends on the angular speed for a given pressure. The characteristic curves are used to drive the pump-turbine's angular speed in function of pressure in order to keep the BEP (equation 16).

$$\omega_{\eta_{max}} = \left(\frac{dP}{\rho_{water} \cdot R^2 \cdot \psi_{\eta_{max}}} \right)^{0.5} \quad 16$$

III.2 Simulation results

III.2.1 Storage cycle simulation

Here is presented an example of what can be a storage cycle. Operating conditions of the compression-expansion cycle are the following:

- Initial pressure of the air: 5 bars.
- Accumulation pressure: 40bar.
- BEP driving strategy
- Near instantaneous mass transfer, i.e. most favourable mass transfer coefficients for air and vapour
- Expansion starts when air reaches ambient temperature and stopped when initial air volume is reached

The evolution of various parameters is shown in the following figures. During compression phase (0 to 150s), angular speed (a) increases in order to maintain pump-turbine's efficiency (e) thus the flow rate (b) increase when pressure grows (c); this produces the increase of the temperature (d). Then, during the wait period (150 to 300s) temperature, thus pressure, decreases because of the heat losses. Finally, during expansion, angular speed decrease, following one's again pressure's evolution.

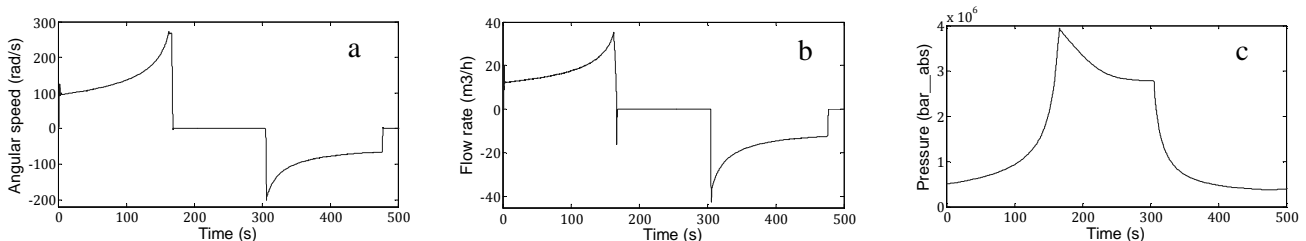

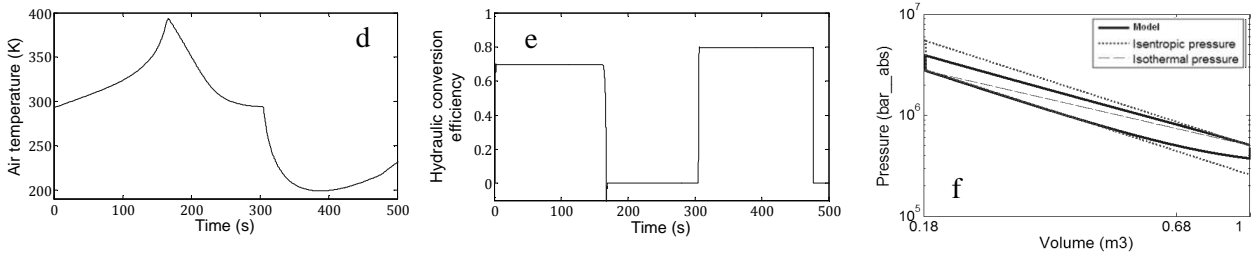

The last figure gives a comparison between the calculated pressure and the isothermal and isentropic ones in function of air volume; the pressure evolves inside the space limited by the two others. Global efficiencies were calculated: storage efficiency (pneumatic energy input/output factor) is about 61%, pump-turbine global efficiency 53% (i.e. 68% during compression phase, 78% during expansion) thus global efficiency for one cycle in presented conditions is 33%.

III.2.2 Sensibility test

The current model is quite complete but the physical parameters used for now can certainly not reproduce reality (i.e. diffusive exchange coefficient for vapour and air diffusion). Sensibility test were done in order to make an idea of the importance of these parameters, specially this driving vapour mass transfer (Sherwood number).

Tests were carried out in the same conditions than in precedent part, except that for a given air transfer coefficient, various vapour transfer coefficients (fig. 7-8) and various initial pressures (5 and 9 bar) were computed. The temperature is observed at the end of the compression and the storage efficiency at the end of the cycle. Figures 7-8 show variation of the maximal temperature and storage efficiency function of the Sherwood number for two initial conditions.

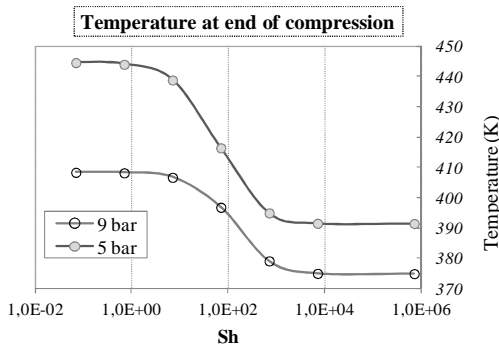

Figure 7

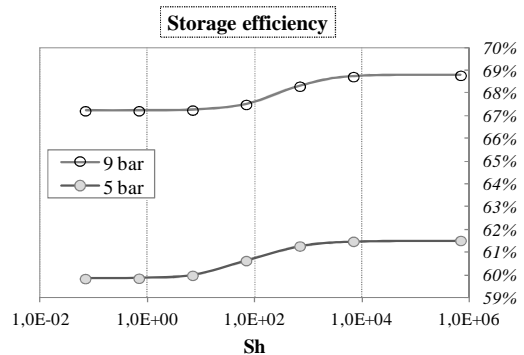

Figure 8

For the both initial conditions, compression final temperature decreases with Sh and this trend (inversed) is also visible in case of the storage efficiency results. In both graphs it is visible how a lower compression rate allows getting closer to an isothermal cycle.

The maximal temperature reached at end of the compression step is function of the compression ratio (P_{init}/P_{max}) and depends also on the global heat flux (figure 7). Low Sherwood number implies a low vaporisation heat flux whereas high Sh implies a near instantaneous vaporization.

IV Conclusion

Hydro-pneumatic storage systems solutions will be completed by the concept proposed here using a rotodynamic pump turbine and a free surface configuration. Since experimental results are not yet

available, only simulation approach was developed here. The presented model introduces, as is it currently possible, the dynamic modelling of this system.

The influence of the heat transfer aspects (especially those linked to mass transfer) was shown. They are susceptible to drive compression final temperature and storage efficiency. But these results and model must be completed / corrected by experimental observations in order to have realistic values for the considered physical parameters.

V Acknowledgements

Current work was carried out thanks to the financial support of the French agency for environment and energy management (ADEME) which must be warmly acknowledged.

Nomenclature

C_{v_i} =	Specific heat at constant volume of gas	R_0 =	Radius of vessel
D =	Vessel diameter	R_{a-b} =	Resistance to diffusive flux
D_{a-b} =	Mass diffusion coefficient	RS_i =	Specific gas constant
h =	Convective heat exchange coefficient	S_{a-b} =	Air-water interface area
HR =	Relative humidity of air	S_h =	Sherwood number
$k_{H,i}$ =	Henry's constant for 'i'	T_0 =	Reference temperature
L_v =	Latent heat of vaporization	T_i =	Space averaged temperature
M_i =	Molar mass	U =	Internal energy
m_i =	Mass of considered element	V =	Gas volume
\dot{m}_i =	Mass flux (kg/s)	δQ =	Global heat flow
P_0 =	Reference pressure	ΔP_p =	Pump/turbine's pressure
P_T =	Total gas pressure (sum of partial pressures)	$x_{i/water}$ =	Molar fraction of 'i' in water
$Pu_{méca}$ =	Pump/turbine's mechanic power	λ_i =	Thermal conductivity of considered region's film temperature
P_i =	Partial pressure of considered element	ρ_i =	Volume mass
P_{sat} =	Saturation vapour pressure	δ =	Dimensionless flow
\dot{Q}_t =	Considered heat flow	η =	Efficiency
r =	Pump/turbine wheel radius	τ =	Dimensionless power
R =	Perfect gas constant	ψ =	Dimensionless pressure
		ω =	Pump/turbine angular velocity

References and Citations

- [1]: <http://www.electricitystorage.org>
- [2]: Sylvain LEMOFOUET – GATSI (2006); - *Investigation and optimisation of hybrid electricity storage systems based on compressed air and supercapacitors*. Ph.D thesis Ecole Polytechnique Fédérale de Lausanne.
- [3]: <http://www.sustainx.com>
- [4]: T. McBride, *Systems and method for energy storage and recovery using rapid isothermal gas expansion and compression*. International Patent Classification: H02J 15/00 (2006.01).
- [5]: A.Pourmovahed, D.R. Otis (1990); - *An experimental Thermal Time Constant Correlation for Hydraulic Accumulators*. Journal of Dynamic Systems, Measurement and Control - March 1990 - Vol. 110.
- [6]: R. Giblin (1974); - *Transmission de chaleur par convection naturelle*. Collections de l'A.N.R.T.
- [7]: David P. DeWitt (2002); - *Fundamentals of Heat and Mass Transfer; Franck P. Incropera*. John Wiley & Sons.
- [8]: A. H. Harvey, S. G. Kaplan, and J. H. Burnett (2005) - *Effect of Dissolved Air on the Density and Refractive Index of Water* - International Journal of Thermophysics, Vol. 26, No. 5, Sept 2005.
- [9]: Antoine Dazin, Guy Caignaert, Gérard Bois (2007). *Transient Behavior of Turbomachineries: Applications to Radial Flow Pump Startups*. ASME, Journal of Fluid Eng., Vol 129.