



HAL
open science

3D modeling of hydral deformation of panel paintings and its confirmation by the experiments

Julien Froidevaux, Martina Müller, Renate Kuhnen, Marco Fioravanti, Luca Uzielli,
Joseph Gril, Parviz Navi

► **To cite this version:**

Julien Froidevaux, Martina Müller, Renate Kuhnen, Marco Fioravanti, Luca Uzielli, et al.. 3D modeling of hydral deformation of panel paintings and its confirmation by the experiments. 4th International Conference of COST Action IE0601 'Interaction between Wood Science and Conservation of Cultural Heritage', Oct 2010, Izmir, Turkey. 6p. <hal-00796405>

HAL Id: hal-00796405

<https://hal.science/hal-00796405v1>

Submitted on 4 Mar 2013

HAL is a multi-disciplinary open access archive for the deposit and dissemination of scientific research documents, whether they are published or not. The documents may come from teaching and research institutions in France or abroad, or from public or private research centers.

L'archive ouverte pluridisciplinaire **HAL**, est destinée au dépôt et à la diffusion de documents scientifiques de niveau recherche, publiés ou non, émanant des établissements d'enseignement et de recherche français ou étrangers, des laboratoires publics ou privés.



HAL Authorization

COST Action IE0601, Izmir International Conference (20-22 October 2010): 3D visco-elastic modeling of hygral deformation of panel paintings and the experiments

*Julien Froidevaux^{1,4}, Martina Müller², Renate Kühnen², Marco Fioravanti³, Luca Uzielli³, Joseph Gril⁴,
Parviz Navi¹.*

¹ *Bern University of Applied Sciences – Architecture, Wood and Civil Engineering, Switzerland*

² *Bern University of Applied Sciences – Bern University of the Arts, Switzerland*

³ *University of Florence – Forest Environmental Sciences and Technologies, Italy*

⁴ *Université de Montpellier II-Laboratoire de mécanique et génie civil- Mécanique de l'arbre et du bois, France*

Abstract

A 3D anisotropic visco-elastic numerical model using finite element method has been implemented in ANSYS using the user programmable feature. This model has been used to simulate the mechanical behavior of wooden panels subjected to variation of the relative humidity and external forces. In this model, the moisture field has been simulated over time, by assuming that water inside wood could move by diffusion. This model is also capable to include the orientation of wood annual rings.

In order to confirm the simulation, the cup-deformation of wooden panels have been measured with a method developed in the University of Florence. Four different kinds of panels with different boundary conditions were tested and the cup-deformation during desorption have been compared with simulations. These comparisons show good fit between experiments and simulations for uncovered boards. But, when one surface of the panel is sealed from water penetration, the experimental curves show irreversible deformation, which are not taken into account in the numerical model.

1. Introduction

Ancient wooden paint panels take an important part of our cultural heritage and are ubiquitous in many church or museum for example. These locations are generally not equipped with climate control system and so impose hard climatic condition to the paint panels. Indeed, the relative humidity of the air can easily within 24 to 48 hours, varying over a range of 10-20 %. These variations over a short period induce stresses and strains that can, in the long term, irreversibly damage the paint panel.

In order to quantify the strain and stress of a panel, which are subject to relative humidity variation, a numerical model using finite element method has been developed.

2. Numerical model

2.1. Elastic and diffusion model

It is commonly assumed that a diffusion process takes place for the time evolution of the moisture content inside wood [1-2]. It is also commonly assumed that a single diffusivity coefficient for both bound water and water vapor can be taken. In this model, the second Fick's law has been computed with mean diffusion coefficients over moisture content. These coefficients have been determined by an analytical inverse methodology using the mass evolution over time [3]. These have been done for the three orthotropic directions of wood. The samples were subjected to a RH change from 76 to 22%.

2.2. Visco-Elastic model

Wood shows an orthotropic visco-elastic behavior. In order to simulate this phenomenon, a model has been developed and implemented using user programmable feature of ANSYS. This model is based on the models of H. Poon and F. Ahmad [4], Z.A. Taylor et al [5] and the Ansys theory

reference on isotropic viscoelasticity [6]. It Consider a rheological Maxwell generalized model given on figure 1. From this, one can write down the stress relaxation in 1D as following:

$$\sigma(t) = E_{\infty} \varepsilon(t) + \sum_{n=1}^N E_n (\varepsilon(t) - a_n(t)) \quad (1)$$

Where N is the number of spring-dashpot series and $a_n(t)$ is the strain of the dashpot n. Extension to the 3D anisotropic case yield:

$$\sigma_{ij}(t) = D_{ijkl}^{\infty} \varepsilon_{kl}(t) + \sum_{n=1}^N (D_{ijkl}^n) (\varepsilon_{kl}(t) - a_{kl}^n(t)) \quad (2)$$

Where D_{ijkl}^n are the orthotropic elasticity matrixes for one branch n. These last matrixes are calculated from experimental relaxation tests. By knowing that on a branch of the Maxwell model, the stress on the spring is equal to the stress on the dashpot (serial assembling), the following differential equation can be deducted:

$$\dot{a}_{kl}^n(t) + \frac{a_{kl}^n(t)}{\tau_n} = \frac{\varepsilon_{kl}(t)}{\tau_n} \quad (3)$$

With $\tau_n = E_n / \eta_n$ the relaxation time of the branch n. The relaxation times have been taken the same for all directions. So it has been set to a scalar value here. The resolution of these inhomogeneous differential equations yield:

$$a_{kl}^n(t) = \varepsilon_{kl}(t) - \int_{-\infty}^t \exp\left(\frac{s-t}{\tau_n}\right) \frac{d\varepsilon_{kl}(s)}{ds} ds \quad (4)$$

Putting the equation (4) into equation (2) it remains:

$$\sigma_{ij}(t) = D_{ijkl}^{\infty} \varepsilon_{kl}(t) + \sum_{n=1}^N (D_{ijkl}^n) \cdot h_{kl}^n(t) \quad (5)$$

The $h_{kl}^n(t)$ functions represent the integral term of the equation (4). They can be compute with an iterative procedure and by using state variables:

$$\begin{aligned} h_{kl}^n(t + \Delta t) &= \int_{-\infty}^{t+\Delta t} \exp\left(\frac{s-t-\Delta t}{\tau_n}\right) \frac{d\varepsilon_{kl}(s)}{ds} ds \\ &= \exp\left(\frac{-\Delta t}{\tau_n}\right) \cdot \int_{-\infty}^t \exp\left(\frac{s-t}{\tau_n}\right) \frac{d\varepsilon_{kl}(s)}{ds} ds + \int_t^{t+\Delta t} \exp\left(\frac{s-t-\Delta t}{\tau_n}\right) \frac{d\varepsilon_{kl}(s)}{ds} ds \end{aligned} \quad (6)$$

The first integral is equal to $h_{kl}^n(t)$ and the second can be compute using the mid-point rules:

$$\int_{x_1}^{x_2} f(x) dx = \Delta x \cdot f(x_1 + \Delta x / 2) \quad (7)$$

Wich yield:

$$h_{kl}^n(t + \Delta t) = \exp\left(\frac{-\Delta t}{\tau_n}\right) \cdot h_{kl}^n(t) + \Delta \varepsilon_{kl} \cdot \exp\left(\frac{-\Delta t}{2\tau_n}\right) \quad (8)$$

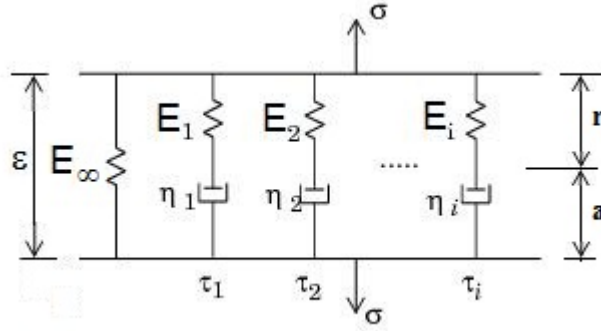

Figure 1 – Generalized Maxwell model

Finally, the material Jacobian is compute as following:

$$\frac{d\sigma_{ij}(t + \Delta t)}{d\varepsilon_{kl}(t + \Delta t)} = D_{ijkl}^{\infty} + (D_{ijkl}^n - D_{ijkl}^{\infty}) \left[\exp\left(\frac{-\Delta t}{\tau_n}\right) \cdot \frac{dh_{kl}(t)}{d\varepsilon_{kl}(t)} + \exp\left(\frac{-\Delta t}{2\tau_n}\right) \right] \quad (9)$$

In order to find the viscoelastic parameters, relaxation tests have been done on the three orthotropic direction of wood. Next the different elasticity matrixes at three relaxation times have been fit from these relaxation curves. Actually, these relaxation experiments were done during 2 days only. Further experiments with longer time will be carried out. The poisson's ratios have been taken as constants. As our panel's simulations have free mechanical boundaries, the shear's stresses are pretty low and so they have been considered to be elastic.

3. Experimental confirmation

The cup-deformation of a massive wooden panel can be measured with a method developed in the University of Florence, as it can be seen on figure 2. This method is based on the precise measurement of the lengths of two linear displacement transducers, which are mounted on columns and run parallel to the wooden surface. Due to geometrical relationships, the change in length of the two transducers can be used to calculate the amount of cupping.

As experimentation, four kinds of spruce wood (*Picea Abies*) panels with different boundary conditions were tested and the cup-deformation during desorption have been measured. The two first panels have no covered surface and were subjected to a change of relative humidity from 65% RH to 12% RH for the first one and from 65% to 33% RH for the second one. The next two boards were prepared with a vapour-tight isolation on different sides. The fours lateral faces were sealed on both boards. Moreover, the third panel has it inner plane from the pith sealed and the fourth has it outer plane from the pith sealed. These last boards were subjected to a 65% to 33% RH variation. These sealing of the outer and inner plane from the pith were done in order to simulate the extreme cases for a paint layer.

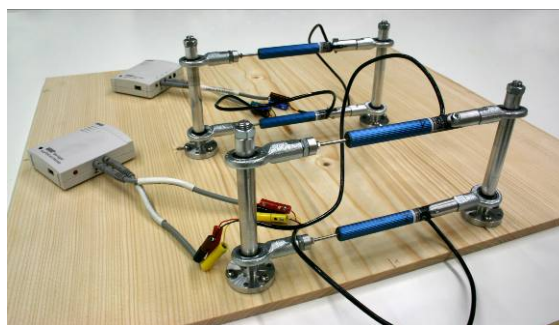

Figure 2 – Experimental setting to determine the amount of cupping of a board. This technique has been developed in University of Florence.

4. Results and analyses

4.1. Elastic versus visco-elastic model

On figure 3 below, can be seen the stresses comparison between elastic and viscoelastic models. These stresses are taken in the x direction at the surface of the board. The boundary condition was a sudden step of relative humidity from 65 to 12%.

This comparison shows a quite important stress relaxation for the viscoelastic model. In terms of cup-deformation, as the panel was free to move, the strain is similar for both models.

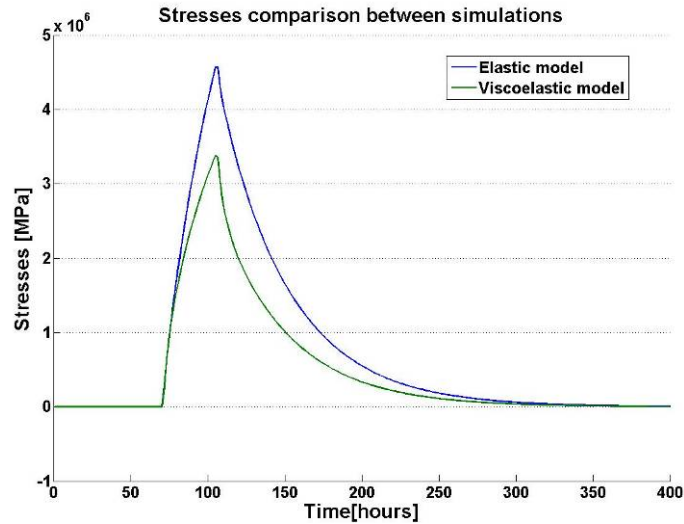

Figure 3 – X-Stresses at the surface of a panel calculated with the elastic and viscoelastic model. A change of relative humidity form 65 to 12% was applied.

4.2. Uncovered panels

The results for the two uncovered panels can be seen on figures 4 and 5. The cup-deformation is quantified by the height of arc between the two columns of the experimental setting. On these last figures, the cup-deformation for both experimental and simulations can be seen.

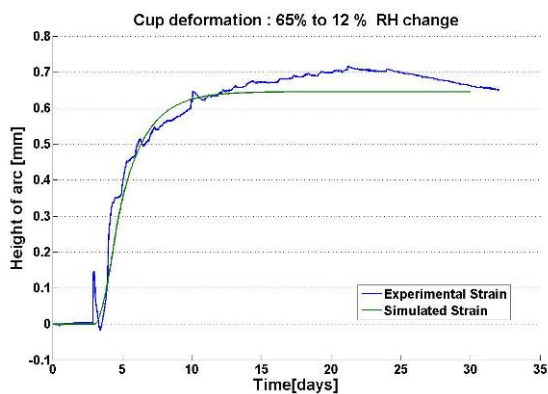

Figure 4 – Cup-deformation of the first B.C.: uncovered board with 65 to 12% RH changes.

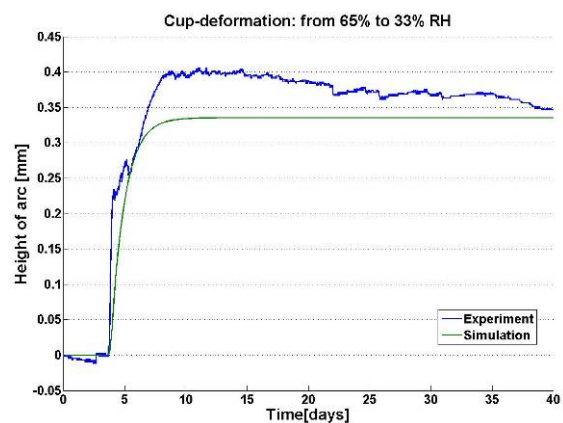

Figure 5 – Cup-deformation of the second B.C.: uncovered board with 65 to 33% RH changes.

The simulation and the experimental results fit pretty well. Concerning the experimental results, it can be seen a decrease of the cup –deformation after the equilibrium is reach. This effect may be due to plastic or mechano-sorptif effects, and so they cannot actually be simulate in our model.

As it can be seen on figure 3, the surface stresses are quite important for the elastic model: 5 MPa. It has been shown that it is not the case in reality [6]. Indeed, the yield stress in radial direction of spruce wood is between 4 to 6 MPa and on the experimental panels no cracks has been seen. The viscoelastic model shows a better representation of reality, but still the mechano-sorptif effect missing.

4.3. Covered panels

The results for the third and fourth boards, which have some surfaces sealed from water penetration, can be seen on figure 5 and 6. They represent the worst case for panel painting. Indeed, with such asymmetric boundary condition, the strains and stresses are maximum for a given step of RH.

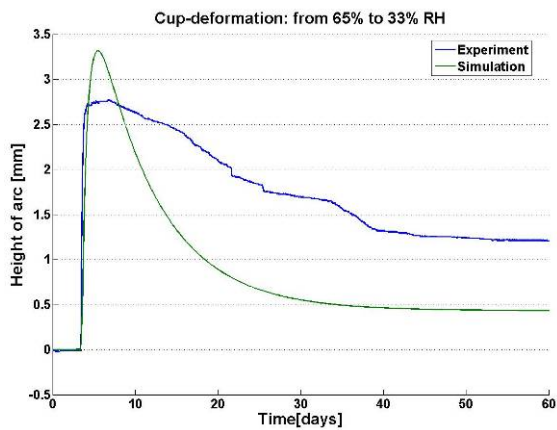

Figure 6 – Cup-deformation of the third B.C.: with the inner plane from the pith sealed with 65 to 33% RH changes.

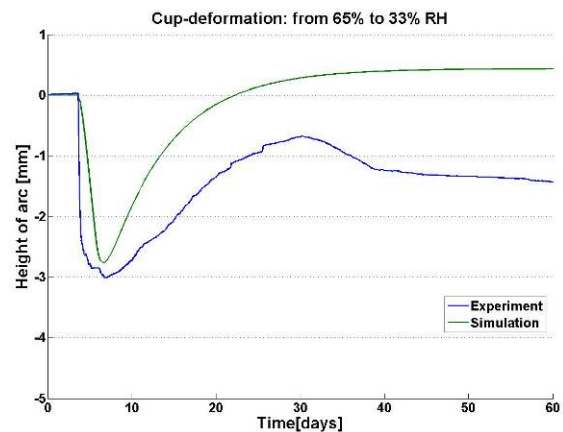

Figure 7 – Cup-deformation of the fourth B.C.: with the outer plane from the pith sealed with 65 to 33% RH changes.

It can be seen from the simulated panels that when the inner plane from the pith is sealed (figure 6), the cup-deformation increase very quickly. Next, as the moisture penetrates the panel thickness, it decreases up to the equilibrium. Comparatively, when the outer face from the pith is sealed, the cupping is in the opposite direction. When the equilibrium is reached, the cupping becomes again positive.

The two experimental boards show a quite important irreversible deformation. Indeed, the simulated equilibrium cup-deformation is about 0.4 mm. The experimental ones are 1.2 mm and -0.8 mm respectively. This is understandable, by considering such huge deformation, that plastic deformation occurs. Moreover, in reality wood shows non-linear viscoelastic behavior. This non-linearity could induce such variation. Finally, for these two cases, the assumption of small displacement of the numerical model is not really appropriate.

5. Conclusions

Our viscoelastic model works quite well. The next steps will be the adding of the paint layer on the boards with appropriate physical properties, specifically the diffusion coefficient of water of this paint layer. It will determine the asymmetry of the moisture field.

In museums panel paintings are subjected to cyclic variation of the relative humidity. In such condition, the mechano-sorption effect could become dominant.

Acknowledgements

The financial support of the Swiss National Science Foundation (FNS) is acknowledged with gratitude.

References

1. Alfred J. Stamm, Raleigh, N. C., Movement of Fluids in Wood - Part II - Diffusion, Wood Science and Technology Vol. 1 (1967) p. 205-230
2. J. Eriksson, H. Johansson, & J. Danvind, A Mass Transport Model for Drying Wood under Isothermal Conditions, Drying technology, 25:3, 433 - 439 (2007).
3. Michel Rappaz, Michel Bellet et Michel Deville, Traité des matériaux N°10: Modélisation numérique en science et génie des matériaux, presses polytechniques et universitaires romandes (1998).
4. H. Poon and M. F. Ahmad (1998): A material point time integration procedure for anisotropic, thermo rheologically simple, viscoelastic solids. Computational Mechanics 21: 236-242.
5. Z.A. Taylor, O.Comas, M. Cheng, J. Passenger, D.J. Hawkes, D. Atkinson and S. Ourselin, On modelling of anisotropic viscoelasticity for soft tissue simulation: Numerical solution and GPU execution, Medical Image Analysis 13 (2009) 234-244.
6. Ansys v.12.1 Product Help: 4.10 Viscoelasticity.
7. R. Reymond, Approche déterministe du séchage des avivés de résineux de fortes épaisseurs pour proposer des conduites industrielles adaptées, Phd thesis, Ecole national du génie rural, des eaux et des forêts, Nancy (2004).