



HAL
open science

Electromagnetic transduction for wireless passive sensors

Patrick Pons, Hervé Aubert, Philippe Menini, Manos Tentzeris

► **To cite this version:**

Patrick Pons, Hervé Aubert, Philippe Menini, Manos Tentzeris. Electromagnetic transduction for wireless passive sensors. EUROSENSORS XXVI, Sep 2012, Krakow, Poland. 10p. hal-00795996

HAL Id: hal-00795996

<https://hal.science/hal-00795996v1>

Submitted on 1 Mar 2013

HAL is a multi-disciplinary open access archive for the deposit and dissemination of scientific research documents, whether they are published or not. The documents may come from teaching and research institutions in France or abroad, or from public or private research centers.

L'archive ouverte pluridisciplinaire **HAL**, est destinée au dépôt et à la diffusion de documents scientifiques de niveau recherche, publiés ou non, émanant des établissements d'enseignement et de recherche français ou étrangers, des laboratoires publics ou privés.

Electromagnetic transduction for wireless passive sensors

^{a,b,*} Patrick PONS, ^{a,b} Hervé AUBERT, ^{a,b} Philippe MENINI, ^c Manos TENTZERIS

^a CNRS, LAAS, 7 avenue du colonel Roche, F-31400 Toulouse, France

^b Univ de Toulouse, LAAS, F-31400 Toulouse, France

^c School of ECE, Georgia Institute of Technology, Atlanta, GA 30332, U.S.A

Abstract

Wireless sensors market is growing very fast these last years tanks to the availability of cheap, small and efficient micro-sensors, batteries, analog and RF circuits, and to the presence of standardized communication protocols. Even if these active sensors are very attractive for a lot of applications, they suffer from weak energy autonomy and they are not compatible with harsh environment. In order to overcome these problems, we have developed a new kind of wireless sensors using electromagnetic transducers and radar interrogation. These passive sensors (battery-less and without electronic components) have been studied for pressure, temperature, gas and stress applications

© 2012 Published by Elsevier Ltd.

Keywords : wireless sensor , passive sensor, electromagnetic transduction, radar interrogation

1. Introduction

Since the late 1990s, the "Ambient Intelligence" (also called "Internet of Things") is the subject of intense research in the world with the goal of interconnecting a large number of objects as intelligent sensors, tags, mobile phones, ... [1-2]. These new smart objects will be able to produce information about their environment and share it with Internet through wireless communications.

In this context, wireless sensor networks emerge as a key technology for numerous applications (domestic, health, environmental, industrial, military, ...) [3-6].

Wireless communication between the sensors and the base station can use different modes of propagation, such as acoustic waves [7-8]. But more often communication uses radio waves (a few tens of MHz to several GHz) because most applications are spread in the air. This type of wave makes it possible to send query distances up to several kilometers and is less sensitive to the obstacles than the optical link. Technologies solutions for the realization of electronic transmitters and receivers are also very well developed in these frequency ranges.

There are three main categories of wireless sensors using radio waves:

- Actives sensors using a transmitter unit integrated with the transducer. This kind of sensors works most often with a battery related to the high consumption of the transmitter. The interrogation distance can be very high (up to several km) but the key limiting factor is sensor autonomy. Another drawback is the low resistance to harsh environments.

* Corresponding author. Tel.: + 33-5-61-33-64-63, *E-mail address*: ppons@laas.fr

- RFID passive sensors [9]. In this case, the transmitter unit is removed from the sensing part and the communication with the base station is performed through backscattering mode. Generally, these sensors function without batteries to take advantage of reduced weight, space and cost. The main advantage compared to active sensors is the very high autonomy as the electronic units are powered through RF link. In return, the interrogation distance is generally lower than 5m.
- SAW passive sensors [10-11]. In this case, all the electronic circuits are removed from the sensing part. The operating principle is based on the generation of an acoustic wave on the surface of a piezoelectric material through an antenna. The backscatter signal is then analyzed in time or frequency domain to extract transducer information as the speed of propagation of the acoustic wave in the piezoelectric material is dependent on several factors (stress, temperature, ...). The two main advantages compared to RFID passive sensors are the fully autonomous nature of these sensors (no need of energy for electronic or transducer part) and the high resistance to harsh environments. But the interrogation distance is generally lower than 10m.

In order to overcome the low interrogation distance of acoustic passive sensors, new kind of electromagnetic transducers are studied since the mid-2000s. The first publications on this topic concerning different kind of sensors are given in Table 1. There is three kind of principle used : the variation of physical or electrical length of a resonator, the modification of coupling between a resonator and a microstructure, the variation of a resonator permittivity. In this paper we present an overview on electromagnetic transducers using the two last principles we developed in our lab since 2005.

Table 1. List of first publications on different passive sensors with electromagnetic transduction

Year	Reference	Laboratory	Kind of sensor	Transducer principle
2004	[12]	California Univ. - USA	Gas	Variation of resonator permittivity
2005	[13]	Manitoba Univ. - Canada	Stress	Variation of air cavity length
2007	[14]	LAAS/CNRS - France	Pressure	Variation of coupling between planar resonator and Si membrane
2007	[15]	Perdue Univ. – USA	Temperature	Variation of coupling between air cavity and cantilevers
2008	[16]	Georgia Inst. Of Tech. - USA	Flux	Variation of coupling between air cavity and membrane
2009	[17]	Tokyo Inst. Tech. - Japan	Crack	Variation of effective length of dipole antenna

2. Pressure sensor

We started this study in 2005 and details about obtained results can be found in [18]. The sensor we developed is based on a planar half-wavelength resonator coupled with a high resistivity silicon membrane (Fig. 1). When the silicon membrane is far away from the resonator, the electromagnetic propagation medium of the resonator is only built by Pyrex (underneath resonator) and air (above resonator). From a given air gap between the silicon membrane and the resonator, evanescent waves start to couple with silicon membrane modifying strongly the resonant frequency of the resonator (Fig. 2.a). The sensor has been fabricated using classical micro-technology process and characterized with a specific pressure probe module allowing on wafer S21 parameters. The sensor exhibits a very high sensitivity

close to 0.37GHz/bar (Fig. 2.b). More recently, passive pressure sensors with other resonator types have been published with comparable sensitivity using coupling principle [19] but also very low sensitivity using the modification of resonator dimension [20].

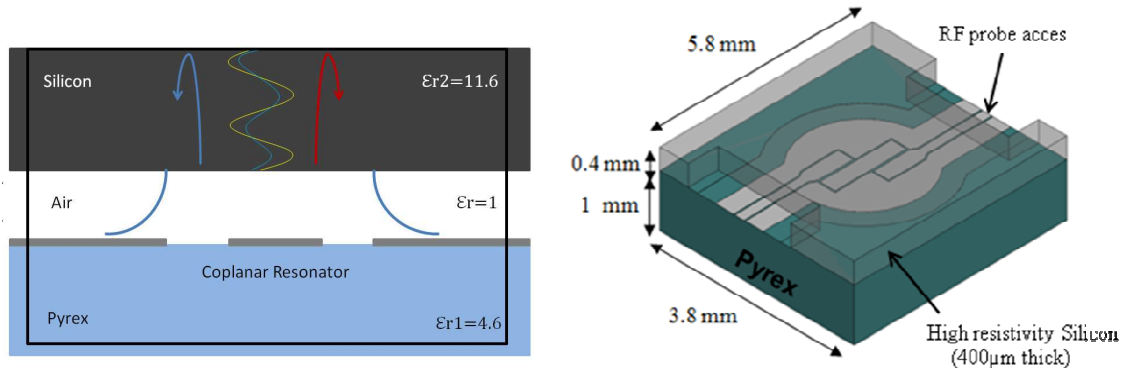

Fig. 1 : Pressure sensor topology

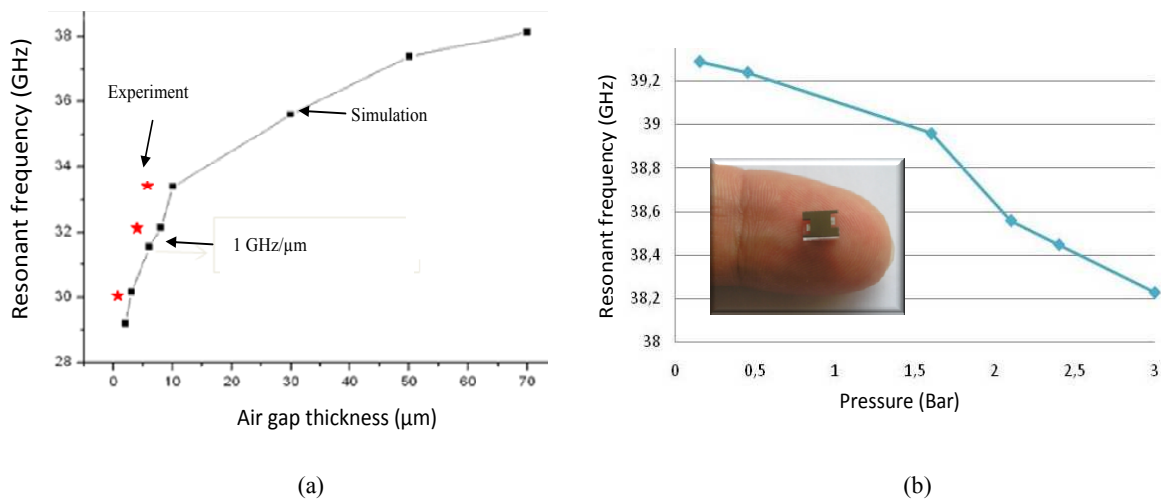

Fig. 2 : Resonant frequency versus (a) air gap (with 300µm thick silicon membrane and uniform membrane displacement) ; (b) pressure (with 45µm thick silicon membrane).

3. Gas sensor

This study started in 2007 and more details can be found in [21]. The gas transducer consists of two Coplanar Wave Guide (CPW) coupled with a cylindrical Dielectric Resonator (DR) (Fig. 3), allowing the excitation of whispering galleries modes inside the dielectric resonator. The spacer, located in the center part of the DR, allows adjusting the vertical coupling between CPW and DR. The sensor principle is based on the dielectric relaxation effect (that corresponds to the dielectric resonator permittivity modification with gas absorption), which leads to the change of the resonance frequency. Simulations performed with a TiO₂ DR have shown that resonant frequency of whispering galleries modes are very sensitive to the modification of the dielectric resonator permittivity (Fig. 4). A prototype has

been fabricated using CPW on a micro-machined silicon substrate, in order to reduce the silicon losses, and a DR in BaSmTiOx. TiO2 DR sensitive to gas are under fabrication in order to validate the sensor response.

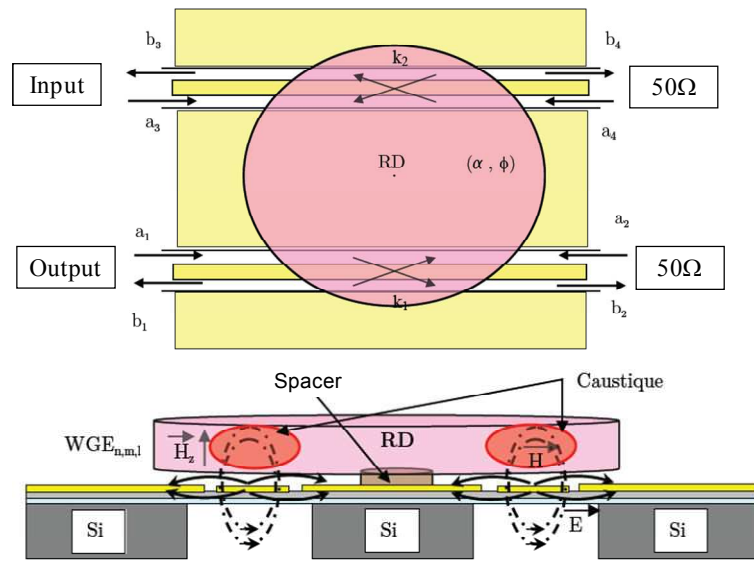

Fig. 3 : Gas sensor topology

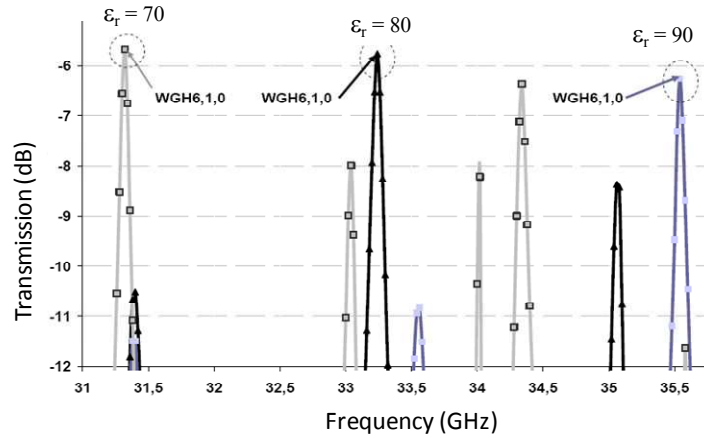

Fig. 4 : S13 parameter versus frequency for different dielectric permittivity (simulations)

4. Temperature MEMS sensor

We started this study in 2009 in collaboration with Georgia Institute of Technology and more details are given in [22-23]. The temperature transducer consists of split ring resonators fabricated on top side of substrate and excited by a coplanar transmission line located on wafer back side (Fig. 5). The slits of the rings are covered with bimorph micro-cantilevers whose layers are made from two different materials. A temperature shift induces the cantilever deflection and then a modification of the coupling capacitance between the two arms of the ring, which leads to the change of the resonant frequency. The principle has been validated at 30GHz by simulation with a 500 μ m-thick Pyrex substrate and with uniform displacement of a purely metallic cantilever. The sensor exhibits a very high sensitivity close to

2.6GHz/ μm . To overcome technological problems, a demonstrator has been first fabricated at 3GHz using classical technology. The rings and the coplanar line are deposited on a 787 μm -thick Neltec substrate (Fig. 6.a). The bilayers cantilever is obtained by the lamination of a 100 μm thick aluminum sheet and a 50 μm thick polyethylene (PET) sheet. Two different temperatures are simulated by two different anchorage thicknesses using PET sheet. The S21 parameter obtained with these two configurations shows a relative resonant frequency shift around 0.2%/ μm (Fig. 6.b).

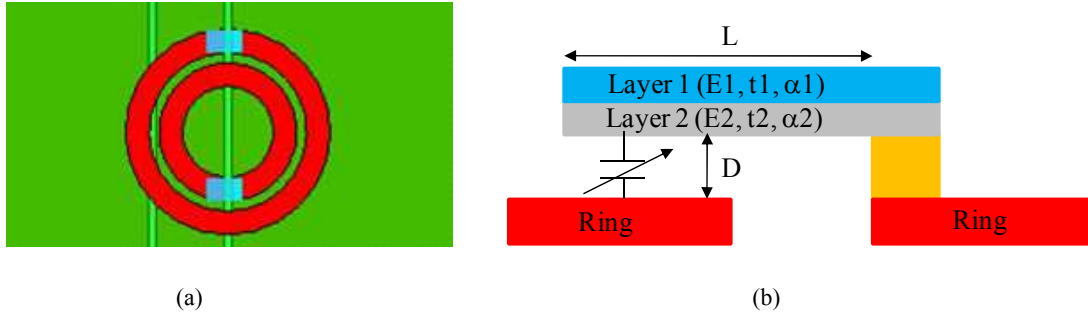

Fig. 5 : (a) Temperature sensor topology. Ring resonators on substrate front side and CPW on back side ; (b) Zoom on bilayer cantilever forming coupling capacitance with ring resonator.

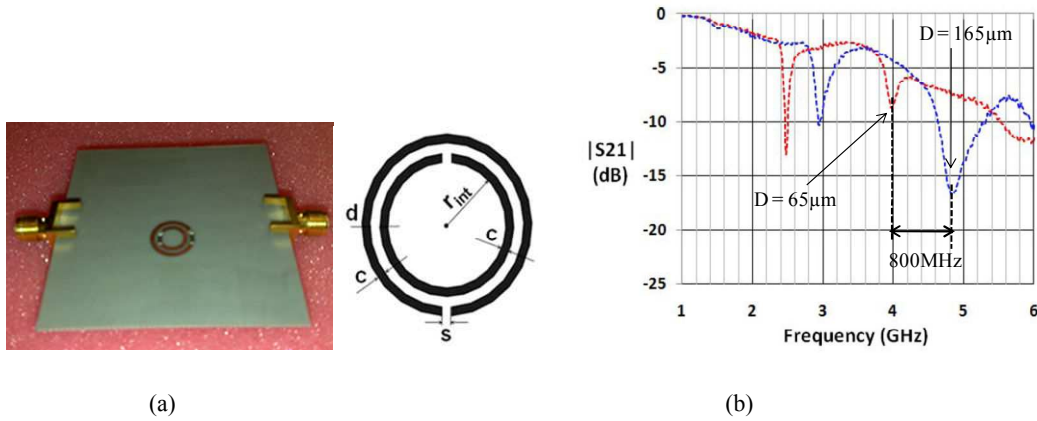

Fig. 6 : 3GHz temperature sensor prototype on 787 μm thick Neltec substrate (a) Sensor view ($r_{\text{int}}=2.5\text{mm}$, $c=1\text{mm}$, $d=0.5\text{mm}$, $s=1\text{mm}$) ; (b) S21 magnitude versus frequency for uniform cantilever displacement.

5. Temperature fluidic sensor

We started this study in 2010 in collaboration with Georgia Institute of Technology and more details are given in [24]. They relate to a temperature sensor whose principle is based on the change in length of an $\lambda/2$ dipole antenna obtained by short-circuiting the two strands of the dipole with a conductive fluid. Each dipole consists of two metal strands of 1mm x 1.5mm. A tank volume and 1mm³ located above one of the two metal strands of the dipole, is filled with conductive liquid. Under the effect of temperature, the liquid expands and moves in a micro-channel (100 microns x 100 microns) which connects the two strands of the dipole. Using Galinstan as conductive liquid, calculations show that one can obtain a fluid propagation inside the channel close to 12 $\mu\text{m}/^\circ\text{C}$. For a certain temperature depending on the distance

between the two strands, a short circuit between the two strands is established which leads to a drastically change of the Radar Cross Section (RCS) of the sensor. By making a dipole array with different distance between the dipole strands, one can obtain an indication of the temperature value.

Devices operating around 30GHz were fabricated on Kapton with an array of 5 dipoles (Fig. 7). Short circuits were achieved by depositing Galinstan drop between the dipole strands. RCS characterizations, performed using a FMCW RADAR, have shown that one can obtain a RCS shift close to 12dBsm for the full scale (Fig. 8). Technological developments are underway to manufacture the devices including microfluidic part. The main difficulty comes from the oxidation of Galinstan even under very low oxygen concentration (5 ppm) which transforms Galinstan into a viscous liquid. Micro-fluidic structures based on SU8 have been manufactured and successfully filled with Galinstan using a controlled atmosphere in a glove box.

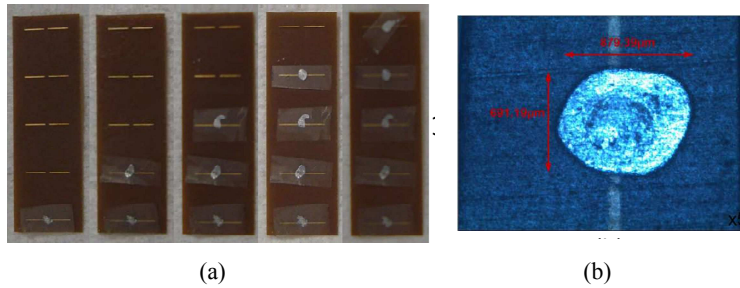

Fig. 7 : (a) Array of 5 $\lambda/2$ dipole antenna with different number of short circuit ; (b) Zoom on short circuit using Galinstan drop

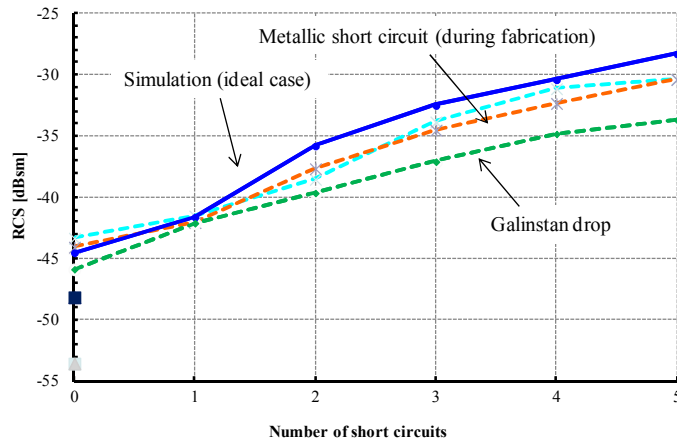

Fig. 8 : RCS of antenna array with different number of short circuits

6. Stress sensor

We started this study in 2010 in collaboration with Georgia Institute of Technology and more details are given in [25]. The sensor is based on two coupled planar resonators (a patch antenna and an open loop) whose resonant frequencies are close to 2.4 GHz. The loop is closed by a variable capacitor which changes with the deformation (Fig. 9). This variable capacitor is formed by a metal cantilever and the free metal of the loop, separated by an insulator of $15\mu\text{m}$ thick. Deformation of the support (100 microns thick Kapton) then causes a displacement of the anchor point of the cantilever. The surface of the capacitor is then modified with sensitivity dependent on the length of the cantilever. The total size of the sensor is $40\text{mm} \times 25\text{mm}$. Simulation results show a maximum sensitivity of $4.5\text{ppm}/\mu\epsilon$. Demonstrators were manufactured with conventional technologies to fabricate the resonators and the cantilever. Then the assembly was performed more or less manually which failed to achieve accurate positioning of the cantilever. However a measured sensitivity of $1.3\text{ppm}/\mu\epsilon$ was obtained, that is as large as what has been published to date (Fig 9).

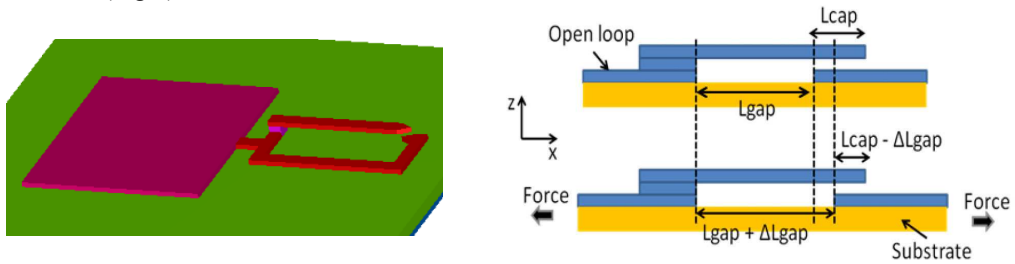
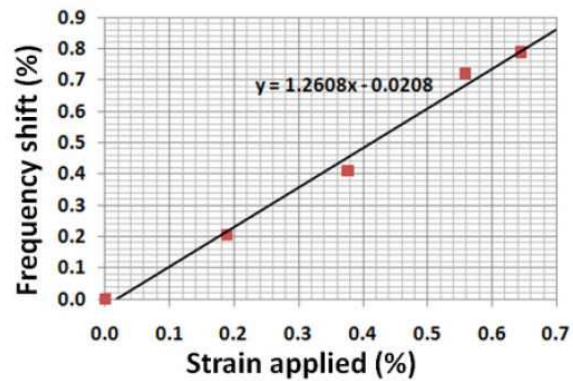

Fig. 9 : Topology of stress sensor



(a)



(b)

Fig. 9 : (a) View of stress sensor under test ; (b) Stress sensor response

7. Radar interrogation

The interrogation system is based on the FMCW (Frequency Modulated Continuous Wave) Radar. From the measured Radar Cross Section (electromagnetic echo) of the sensors, the physical quantity can be remotely and wirelessly derived and the identification of the sensor can also be performed [26-27]. The simplified block diagram of the interrogation unit, operating in homodyne principle, is shown in Fig. 10. The Voltage Control Oscillator generates a frequency signal which increases linearly for a frequency sweep period. This signal propagates from the transmission horn antenna to the sensor target that is composed by an antenna loaded by the sensor die. This signal is then reflected back by the target, recovered by the receiving antenna of the reader and mixed with the input signal to obtain the intermediate frequency. The analysis of this frequency beat level permits then to detect the variation of the sensor load (that is linked to the the shift of the sensor resonant frequency and then to the measured value).

A Radar, operating between 26GHz and 31GHz has been designed and fabricated (Fig 11). The interrogation principle up to 30m has been first validated using 1 cm² passive target and few mW for Radar emission. The sensor die was connected via RF probes to an external horn antenna, placed at 3m from the Radar (Fig. 12). An example of Radar response is given in Fig. 13 for the pressure sensor.

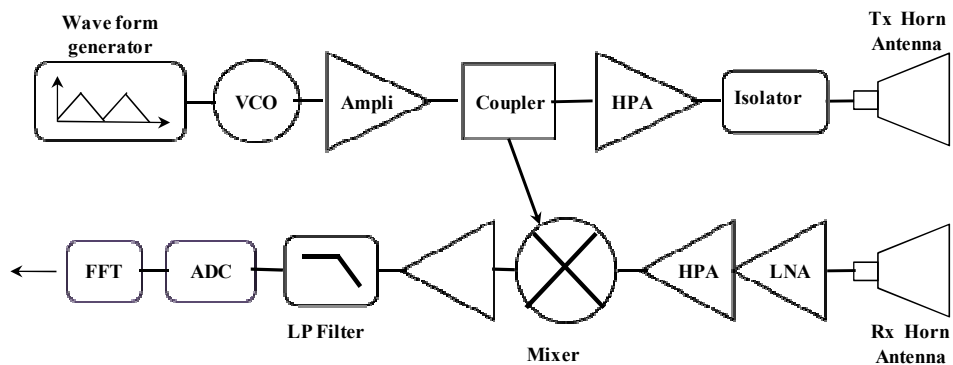

Fig. 10 : : Simplified block diagram of the interrogation unit

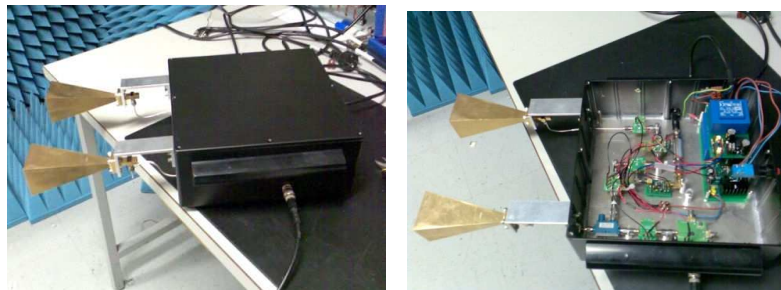

Fig. 11 : Photographies of the fabricated Radar prototype

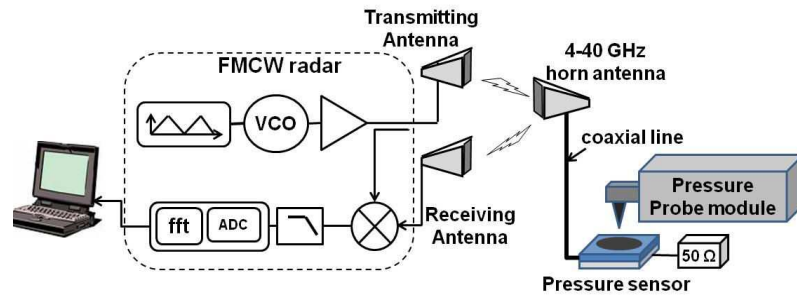

Fig. 12 : Set up used for pressure sensor interrogation by Radar

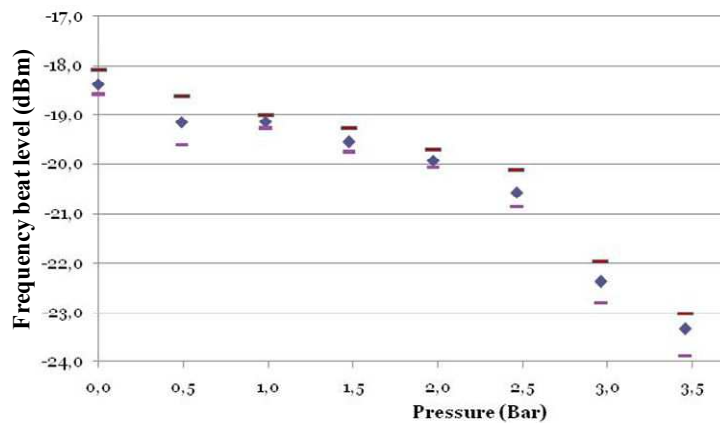

Fig. 13 : Radar response of pressure sensor

8. Acknowledgements

Part of this work is supported by the French Project of ‘Pôle de compétitivité’ entitled ‘Système Autonome Communicant En Réseau’ (SACER). All these studies have been performed with PhD students (Mehdi JATLAOUI, Hamida HALLIL, Franck CHEBILA, Thai TRANG, Sofière BOUAZIZ, Anya TRAILLE).

9. References

- [1] Internet of Things in 2020. *EPoSS Report 2008*
- [2] L Atzori, A Iera, G Morabito. The Internet of Things: A survey. *Computer Networks* 54 (2010), 2787-2805
- [3] IF Akyildiz, W Su, Y Sankarasubramaniam, E Cayirci. Wireless sensor networks, a survey. *Computer Networks* 38 (2002) 393-422
- [4] L Ruiz-Garcia, L Lunadei, P Barreiro, J Robla. A Review of Wireless Sensor Technologies and Applications in Agriculture and Food Industry. *Sensors* 2009, 9, 4728-4750
- [5] E Sardini, M Serpelloni. Passive and Self-Powered Autonomous Sensors for Remote Measurements. *Sensors* 2009, 9, 943-960

- [6] H Alemdar, C Ersoy. Wireless sensor networks for healthcare, A survey. *Computer Networks* 54 (2010) 2688–2710
- [7] F Umbrecht, P Wagli, S Dechand, F Gattiker, J Neuenschwander, U Sennhauser. C Hierold. Wireless implantable passive strain sensor. *J. Micromech. Microeng.* 20 (2010)
- [8] M O’Toole, D Diamond. Absorbance based light emitting diode optical sensors and sensing devices. *Sensors* 2008, 8, 2453-2479
- [9] T Sanchez Lopez. RFID and sensor integration standards: State and future prospects. *Computer Standards & Interfaces* 33 (2011) 207–213
- [10] A Pohl. A Review of Wireless SAW Sensors. *IEEE Transactions on Ultrasonics, Ferroelectrics, and Frequency Control*, vol. 47, no. 2, march 2000
- [11] M Pereira, RJ Lad, P Davulis, A Canabal, T Moonlight, S Moulzolf, DJ Frankel, T Pollard, D McCann, E Dudzik, A Abedi, D Hummels, G. Bernhardt. Wireless Acoustic Wave Sensors and Systems for Harsh Environment Applications. *Wireless Sensors and Sensor Networks Conference, 16-19 Jan. 2011, Phoenix, USA*
- [12] M McGrath, R Sabouni, A Pham. Development of nano-based resonator gas sensors for wireless sensing systems. *Proceedings of the SPIE 2004, Volume: 5593, Issue: 1, Pages: 62-72*
- [13] J. Chuang, D. J. Thomson, and G. E. Bridges. Embeddable wireless strain sensor based on resonant RF cavities. *Review of Scientific Instruments*, 76 (2005)
- [14] M Jatlaoui, P. Pons, H.Aubert. Radio Frequency Pressure Transducer . *European Microwave Week (EUMC2007), 8-12 October 2007, Munich, Germany*
- [15] A Mahmood, H Sigmarsson, H Joshi, W Chappell, D Peroulis. An Evanescent-mode Cavity Resonator Based Thermal Sensor . *IEEE sensors 2007, 28-31 Oct 2007, Atlanta, USA*
- [16] Y Zhao, SH Kim, Y Li, B Pan, X Wu, M Tentzeris, J Parapolymou, MG Allen. A Micromachined Airflow Sensor Based on RF Evanescent-Mode Cavity Resonator. *IEEE MTT-S 2008, 15-20 June 2008, Atlanta, USA*
- [17] R Matsuzaki, M Melnykowycz, A Todoroki. Antenna/sensor multifunctional composites for the wireless detection of damage. *Composites Science and Technology* 69 (2009) 2507–2513
- [18] M. Jatlaoui, F. Chebila, P. Pons, H. Aubert. Working Principle Description of the Wireless Passive EM Transduction Pressure Sensor. *European Physical Journal - Applied Physics, Vol 56, N°1, oct 2011*
- [19] D. E. Senior, X. Cheng, P. Jao, C. Kim, J.K. Kim, Y.K. Yoon. Wireless Passive Sensing Application Using a Cavity Loaded Evanescent Mode Half Mode Substrate Integrated Waveguide Resonator. *Transducers’11, Beijing, China, June 5-9, 2011*
- [20] A. Ibrahim, D.R.S. Cumming. Passive single chip wireless microwave pressure sensor. *Sensors and Actuators A* 165 (2011) 200–206
- [21] H.Hallil, F.Chebila, P.Menini, H. Aubert. Feasibility of passive Gas sensor based on whispering gallery modes and its RADAR interrogation: theoretical and experimental investigations. *Sensors & Transducers Journal, Vol.116, N°5, pp.38-48, Mai 2010*
- [22] T. Thai, M Jatlaoui, H Aubert, P Pons, G. DeJean, M Tentzeris, R Plana. A Novel Passive Wireless Ultrasensitive Temperature RF Transducer for Remote Sensing, *International Microwave Symposium, May 23-28 2010, Anaheim (USA)*
- [23] Trang T. Thai, Jatlaoui M. Mehdi, Franck Chebila, HerveAubert, Patrick Pons, Gerald R. DeJean, Manos M. Tentzeris, and Robert Plana. Design and Development of a Novel Passive Wireless Ultrasensitive RF Temperature Transducer for Remote Sensing. *Accepted for publication in IEEE Sensor Journal*
- [24] A.Traill, S.Bouaziz, H.Aubert, P.Pons, M.M.Tentzeris. A Novel Wireless Passive Temperature Sensor Utilizing Microfluidic Principles in Millimeter-Wave Frequencies. *IEEE Sensors, 28-31 October 2011, Limerick, Ireland*
- [25] T Thai, H Aubert, P Pons, R Plana, M Tentzeris. A Newly Developed Radio Frequency Wireless Passive Highly Sensitive Strain Transducer. *IEEE Sensors, 28-31 October 2011, Limerick, Ireland*
- [26] F. Chebila, M. Jatlaoui, P. Pons, H. Aubert. Reconfigurable Multi-band Scatterers for Micro-Sensors Identification. *IEEE International Symposium on Antennas & Propagation, June 1-5 2009, Charleston, USA,*
- [27] M. Jatlaoui, F. Chebila, S. Bouaziz, P. Pons, H. Aubert. Original Identification technique of passive EM Sensors using Loaded Transmission Delay Lines. *European Microwave Week (EUMC2010), 26 Sept-1 Oct 2010, Paris, France*