



HAL
open science

Viscoelastic behaviour of aged and non-aged spruce wood in the radial direction

Julien Froidevaux, Thomas Volkmer, Christelle Ganne-Chédeville, Joseph Gril, Parviz Navi

► **To cite this version:**

Julien Froidevaux, Thomas Volkmer, Christelle Ganne-Chédeville, Joseph Gril, Parviz Navi. Viscoelastic behaviour of aged and non-aged spruce wood in the radial direction. *Wood Material Science and Engineering*, 2012, 7 (1), pp.1-12. 10.1080/17480272.2011.629735 . hal-00789603

HAL Id: hal-00789603

<https://hal.science/hal-00789603v1>

Submitted on 9 Oct 2024

HAL is a multi-disciplinary open access archive for the deposit and dissemination of scientific research documents, whether they are published or not. The documents may come from teaching and research institutions in France or abroad, or from public or private research centers.

L'archive ouverte pluridisciplinaire **HAL**, est destinée au dépôt et à la diffusion de documents scientifiques de niveau recherche, publiés ou non, émanant des établissements d'enseignement et de recherche français ou étrangers, des laboratoires publics ou privés.

Viscoelastic behaviour of aged and non-aged spruce wood in the radial direction

JULIEN FROIDEVAUX^{1,2}, THOMAS VOLKMER¹, CHRISTELLE GANNE-CHEDEVILLE¹,
JOSEPH GRIL² & PARVIZ NAVI¹

¹Department of Architecture, Wood and Civil Engineering, Bern University of Applied Sciences, Biel/Bienne, Switzerland

²Laboratoire de mécanique et génie civil, Mécanique de l'arbre et du bois, Université de Montpellier II, Montpellier, France

The mechanical behaviour of non-aged (modern) and aged spruce [*Picea abies* (L.) Karst.] wood was investigated in the radial direction using a microtensile testing device. The size of the samples was 50 × 3 × 3 mm (radial × tangential × longitudinal). Elastic, creep, relaxation, rupture and mechanosorption tests were carried out under controlled temperature and relative humidity. Optical and electronic micrographs were produced in order to correlate the mechanical behaviour with the wood structure. Results indicate that the overall mechanical properties such as Young's modulus and the time-dependent behaviour of wood in the radial direction do not change significantly with age. However, the strength of aged wood shows a decrease of about 25% in the radial direction. This loss of strength in aged wood might be explained by localized damage at the microstructural level in the wood.

Keywords: *Aged wood, creep, mechanosorption, natural ageing, relaxation, spruce, viscoelastic.*

Introduction

Wood as an organic material is part of the carbon cycle in nature. Wood formation and its degradation are the essential elements of this cycle. Wood can be degraded by heat, humidity, chemical agents and also by nature. Natural degradation of wood depends on environmental conditions, e.g. weather and ultraviolet (UV) light, as well as biochemical degradation by fungi and damage by insects. Nevertheless, if wood is kept under certain circumstances, such as low relative humidity (RH) and little exposure to sunlight or frost, it can last for centuries. During ageing, structural and chemical changes occur. The analysis of these changes, induced by time at low temperature and humidity, is a new field in wood science and many questions remain unresolved.

The effects of ageing in wood in terms of physical, mechanical and chemical degradation have been studied by Kohara (1952, 1953), and more recently by Erhardt and Mecklenburg (1995), Erhardt *et al.* (1996) and Obataya (2007, 2009). Erhardt and co-

workers found no clear differences in mechanical properties between aged and non-aged wood. However, they detected some chemical changes such as hydrolysis of xylan. In contrast, experiments performed by Kohara on wood samples aged between 300 and 1300 years, from old constructions in Japan, show that the longitudinal Young's modulus of aged wood increases by around 20% during the first 300 years. After that time, the modulus decreases slowly. It has been shown that this phenomenon is due to the crystallization of cellulose and depolymerization of the hemicelluloses (Obataya, 2009).

The field of interest of these studies was wood constructions, and so the focus was on the longitudinal direction. The main objective of the present investigation was to compare the long-term and short-term micromechanical properties of aged and non-aged wood in the radial direction. This direction is of great importance for the preservation of ancient wooden artworks such as old painting panels, where damage can frequently occur.

Materials and methods

Two types of spruce wood [*Picea abies* (L.) Karst.] were analysed, with samples of non-aged wood and three different aged woods.

The non-aged wood was grown in central Switzerland near Schattdorf (Department Uri) and was cut in 2007 (3 years old). Three different annual ring width samples were included in the investigation: narrow (width < 2 mm), middle (width \cong 2 mm) and wide (width > 2 mm). The dry densities were 411, 404 and 388 kg m⁻³, respectively.

The aged woods were sourced from different historical buildings. The ages of the samples were determined by dendrochronology and varied between 100 and 700 years (considered from the felling of the tree).

Wood is part of the biological cycle and so is always prone to attack by insects and microorganisms, more especially in the case of aged wood. To generate reproducible results it is necessary to perform the mechanical tests on wood that has not been degraded by fungal or insect attack. For this reason a comprehensive study was performed to select aged wood without such degradation. All aged wood samples were selected by optical microscopy. Thus, the quality of the aged wood was examined and evaluated. Finally, three age categories were selected: 500 years old (1521), 400 years old (1610) and 200 years old (1760). The 200- and 500-year-old samples came from framework beams, and the 400-year-old sample came from a parquet floor. Their respective densities were 414, 392 and 394 kg m⁻³. All these wood samples can be considered as aged under indoor conditions (low temperature, low RH, no contact with water and low UV radiation).

Mechanical testing device

The equipment used in this study was developed at EPFL (Swiss Institute of Technology, Lausanne) and was used by V. Pittet in her investigation of transient moisture effects in wood (Pittet, 1996; Navi *et al.*, 2002). This device consists of two units: the mechanical testing part and the climate control unit. Both temperature and relative humidity (RH) can be controlled. The mechanical testing device was a horizontal testing machine with 1 kN load capacity. The maximum load used was 50 N. The machine could operate under force or deformation control. The deformation was measured with an inductive extensometer of 20.2 mm length mechanically fixed to the sample with two springs.

The second unit comprised all devices of the climate control system. A cylindrical hygrothermal cell 20 cm long and 8 cm in diameter surrounded the

fixed sample in the testing machine. The walls of this cell were made of double-layered Plexiglas®. The temperature inside the cell was kept constant by running water through the cell walls. The water temperature was regulated with a thermostatic bath and the RH was controlled by mixing dried and wet air. Dry air came from the air pressure system of the building and had about 6–7% RH. The wet air was produced with a cylinder filled with water. The back of this cylinder was made of a ceramic foam that was permeable to air and impermeable to water. By injecting dried air at the back through the ceramic and then through the water, the air output on the top was saturated with water at 97–98% RH. The humidified air was preheated to avoid local condensation, and conveyed into the Plexiglas® testing chamber.

Experimental methodology

Sample preparation

To characterize the viscoelastic behaviour of wood, the samples must be kept at constant temperature and moisture content during the test. Small elements of 3 × 3 mm² (T × L) in cross-section were used to reach fast thermohydral stabilization; 3–4 h was required to reach the equilibrium moisture content (EMC).

To measure the mechanical properties of these elements in the radial direction, a special sample preparation procedure was necessary (Figure 1). This consisted of the following steps: the wood samples were cut into small square rods with dimensions 50 × 3 × 3 mm (radial × tangential × longitudinal). Next, the rods were put into a silicone mould and the two ends of the rods were reinforced with an epoxy resin to avoid any damage due to fixing in the clamps of the testing device. Finally, the samples were conditioned to one or other of the two specific climates of 22% and 76% RH.

Mechanical tests

First, tests were conducted to determine the Young's modulus and the failure stress. The speed of the force increase was set at 0.5 N s⁻¹. At this speed, about 2 min is required to reach the failure stress. These tests were carried out 10 times for each kind of wood at two different climatic conditions: at 22% and 76% RH, both at 23°C.

After these tests, the time-dependent behaviour of the wooden samples was determined. First, the EMC was controlled by maintaining the sample under zero force for at least 4 h. Next, creep-recovery tests at a constant stress of 1.6 MPa



Figure 1. Sample preparation: embedding of the two ends of the samples in epoxy resin with a silicone mould. The dimension of the samples was $50 \times 3 \times 3$ mm (radial \times tangential \times longitudinal).

($\sim 25\%$ of the failure stress) were carried out for 2 days of creep and half a day of recovery. Finally, stress relaxation-erasing tests were performed, at constant deformation of 0.25% . Creep and relaxation tests were performed at least once for each wood sample under the two different climatic conditions: 23°C , and 76% and 22% RH.

Finally, tests under varying climate conditions were carried out. These tests were performed as follows. First, the samples were equilibrated at 22% RH. Then, to quantify the free hygral strain of the sample, zero force was maintained and three humidity cycles from 22% to 76% were applied, as can be seen in Figure 2. Next, a stress of 1.2 MPa was applied to the samples and the same three humidity

cycles were repeated. After these humidity cycles, the stress was released and two further humidity cycles were imposed, in order to quantify the recovery. The procedure of the application of force, RH and the resulting deformation can be seen in Figure 3.

Optical microscopy

Several microcuts in the transverse plane were prepared with a thickness of $2\text{--}3 \mu\text{m}$ for each kind of wood. The preparation was carried out at the Institut für Forstbotanik at the University of Freiburg (Germany) and included the following steps: cutting of the samples, dehydration of the samples for 1 week, soaking the samples in an acrylic resin,

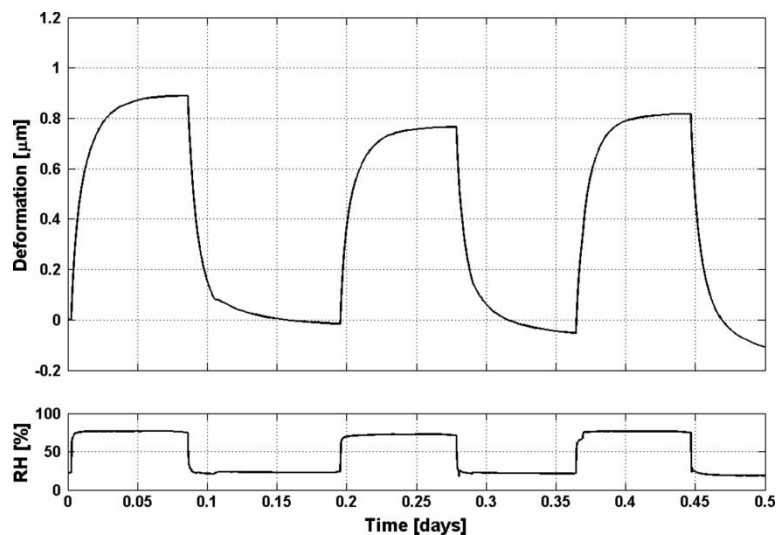

Figure 2. Free hygral deformation and climatic cycles according to time. Stresses were kept at zero and the relative humidity (RH) cycle was repeated three times.

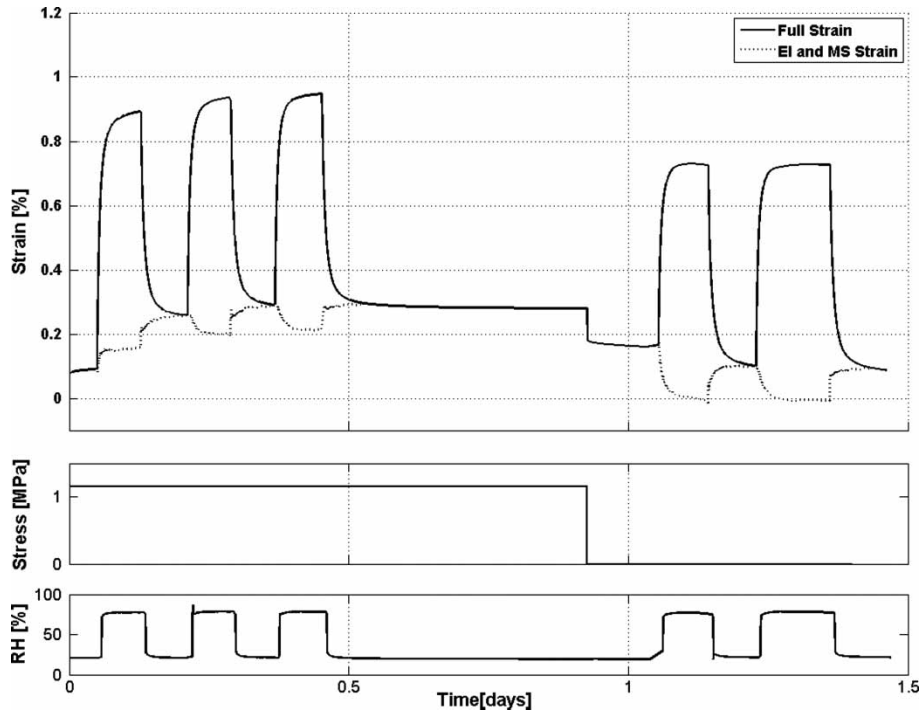

Figure 3. Mechanosorptive tests in the radial direction of 400-year-old aged wood. Stress was applied on the sample for 1 day, and three relative humidity (RH) cycles from 22% to 76% were applied. Then, the stress was released and two more RH cycles were applied. The full strain corresponds to the total measured strain, and the dashed line corresponds to the total strain minus the free hydal deformation.

slicing the microcuts with a rotation microtome, colouring the samples with a mixture of three colours and embedding the samples in resin. After the preparation, the micro-objects were analysed with a light microscope (Leica DMLM) at different magnifications up to $400\times$. Different light sources were used: white and UV light. For a better differentiation of the wood components, polarization and different phase-contrast filters were used.

Scanning electron microscopy

A scanning electron microscope (Hitachi TM-1000) was used to complete and verify the optical microscopy investigation. The sample preparation procedure was as follows: the samples were first boiled in water at 110°C for 6 h. Then they were placed in a solution of water and glycerine for 1 week. These steps are required to soften the samples. Afterwards, the $T \times R$ plane of the samples was cut with a sliding microtome to achieve a clear cut. A final cut was made by hand with a fine razor blade. Finally, the samples were coated with a metal film.

Results and discussion

Failure stresses

The radial tensile rupture stress under the two different climatic conditions is shown in Figure 4.

No significant difference can be seen between the three non-aged wood samples. This may indicate that the width of the annual rings in the samples does not influence the tensile strength in the radial direction. The mean value was about $5.5 \pm 15\%$ MPa. This value is slightly greater than those in the literature: 2–5 MPa (Kollmann, 1951). However, owing to the size effect of wood, the strength should be higher for small samples than for normalized samples. It has been shown that the impact of the rays on the strength in the radial direction is not negligible (Burgert *et al.*, 1999, 2000), but because of the dimension of the cross-section (3×3 mm) the influence of the rays is probably average.

Concerning the aged wood samples, there was a clear difference between the 400-year-old sample and the two other samples of aged wood (namely of 200 and 500 years). The failure of all samples always took place in the region of the first three cell rows of the earlywood, i.e. in the vicinity of the annual ring border. According to the optical analysis outlined below, in the section *Optical and electron microscopy*, the thickness of the radial cell walls in this zone was significantly greater for the 400-year-old wood than for the others (Table I). Comparing the density, the samples were similar. However, the density profile between latewood and earlywood was different for the 400-year-old wood compared with the others. This is the most likely explanation for the high radial strength of the 400-year-old wood.

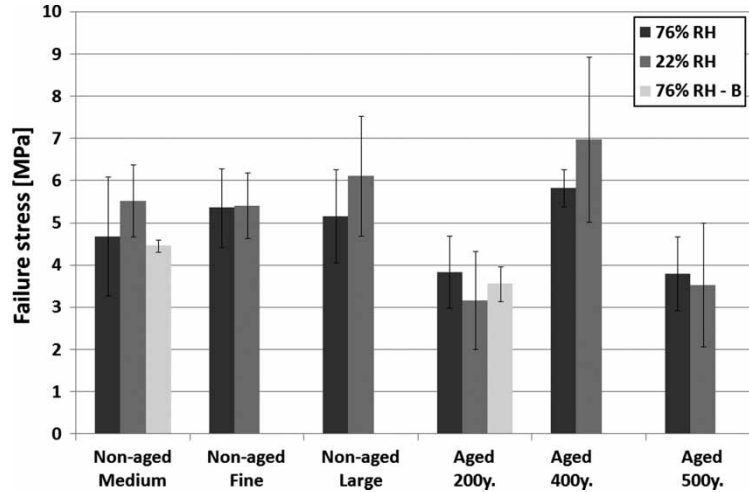

Figure 4. Average radial tensile failure stress and the standard deviation at 76% and 22% relative humidity (RH) of non-aged and aged spruce wood samples. Each bar corresponds to a mean of 10 tests. The third series (light grey) corresponds to tests done at 76% RH with a bigger section sample (50 mm²).

The two other samples of aged wood showed a distinct reduction of about 25% in rupture stress compared with the non-aged wood (Figure 4). Unfortunately, the precise history of use of the aged sample was not known and no ageing time correlation could be seen between the samples.

Young's modulus

The Young's modulus for all samples was within the same range, as can be seen from Figure 5. This shows that there was no clear tendency for a modification of the stiffness in the radial direction during the ageing of the samples. This can be explained by the components that determine the stiffness of the wood in the principal directions. In the longitudinal direction the cellulose mainly governs the stiffness. Owing to the probable increase in crystallinity during ageing, an increase in stiffness is most likely, as has been shown by Kohara (1952) and Obataya (2009). But in the radial direction, the percentage of radially oriented cellulose is small. Only in the cell-wall layers S1 and S3 were microfibrils radially oriented with angles of about 80°.

Therefore, the modification of the crystallinity of cellulose appears to have a low influence. Lignin and hemicelluloses have a more dominant influence on the stiffness in the radial than in the longitudinal direction.

Viscoelastic tests

To investigate the viscoelastic behaviour of aged and non-aged wood, creep and relaxation tests were performed. As these are long-term tests, the results contain a certain amount of noise, specifically for the relaxation tests. Therefore, the results are shown after a smoothing done by a local second order polynomial interpolation.

Creep tests

The results of the creep tests are shown in Figures 6 and 7 for the climatic conditions of 22% and 76% RH, respectively. The relative creep strain ε_{vs} is calculated as:

$$\varepsilon_{vs} = \frac{\varepsilon - \varepsilon_{E1}}{\varepsilon_{E1}} \quad (1)$$

Table I. Dry densities and radial cell wall thicknesses (mean of 60 measurements) in the second and third layer of cells in the earlywood region.

		Density (kg m ⁻³)	Earlywood cell-wall thickness (μm)
Non-aged	Fine	411	–
	Medium	404	3.6
	Large	388	–
Aged	200 years	414	4.1
	400 years	392	5.1
	500 years	394	3.1

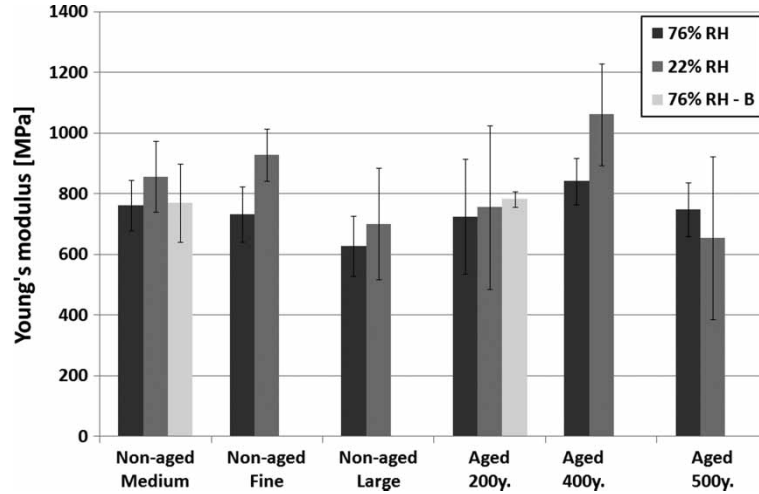

Figure 5. Average radial Young's modulus and the standard deviation at 76% and 22% relative humidity (RH) of non-aged and aged spruce wood samples. Each bar corresponds to a mean of 10 tests. The third series (light grey) corresponds to tests done at 76% RH with a bigger section sample (50 mm^2).

where ε_{E1} is the instantaneous elastic strain and ε the total strain.

The results show significant creep for all specimens. Under dry conditions, at 22% RH, the relative creep after 2 days was between 35% and 65% of the elastic strain. As expected, the creep in the wet state at 76% RH tended to be a little higher than in the dry state, and varied between 50% and 75% after 2 days.

There was little difference between the creep of aged and non-aged wood samples. Under dry conditions, non-aged wood tended to creep a bit less than aged wood. During wet conditions (Figure 7) the creep behaviour was similar to the creep in the dry state. The difference between aged and non-aged wood samples was not perceptible in the wet climate.

Comparing the creep recovery of the different samples, no significant change could be seen. Each

sample showed an irreversible deformation after 1 day of recovery of about 20% of the instantaneous strain.

It is important to note that for most of the creep tests, only one sample could be tested. Although a tendency was visible, more experiments would be necessary for a detailed interpretation.

Relaxation tests

The relaxation behaviour of aged and non-aged wood for different climatic conditions is shown in Figures 8 and 9. The relative relaxation stress σ_{vs} is calculated as:

$$\sigma_{vs} = \frac{\sigma - \sigma_{E1}}{\sigma_{E1}} \quad (2)$$

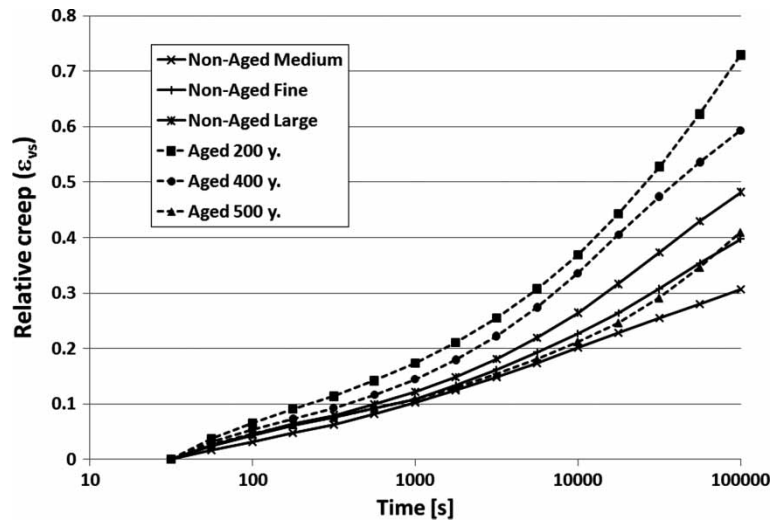

Figure 6. Radial relative creep strain (ε_{vs}) versus the log of time under climatic conditions of 22% relative humidity.

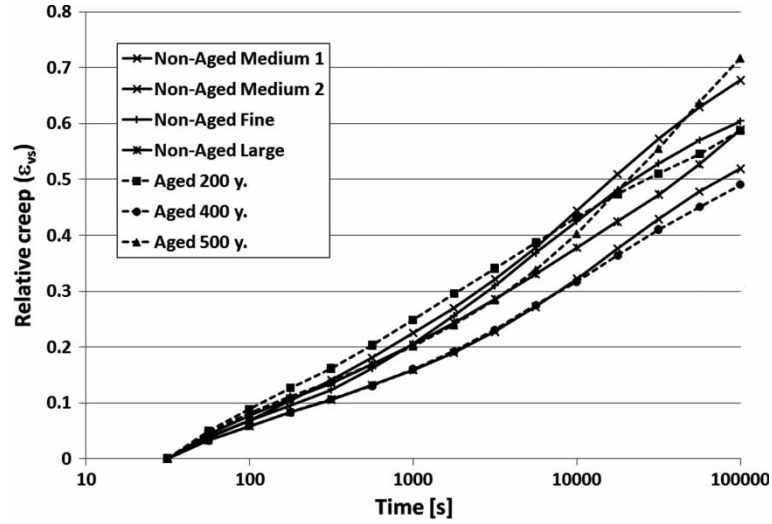

Figure 7. Radial relative creep strain (ϵ_{VS}) versus the log of time under climatic conditions of 76% relative humidity.

where σ_{EI} is the instantaneous stress and σ the total stress.

As in the creep tests, the stress relaxation tests confirmed that natural ageing of several hundred years does not greatly change the time-dependent behaviour of wood. The relative relaxation for all samples in dry conditions was in the range 30–45% of the instantaneous stress. Similarly to the creep tests, it seems that aged wood relaxes a little more than non-aged wood.

The relaxations in the wet state (Figure 9) gave results that were a bit more distinct, and the absolute values were higher than in dry conditions. The relative relaxation stresses were between 30% and 50%. No tendency could be seen for aged samples to relax in a different way from non-aged ones.

Comparing the stress erasing, as for the creep recovery, it seemed that no significant change occurred during ageing. However, as only one relaxation test was carried out for each type of wood, a tendency was visible, but more experiments would be necessary for a detailed interpretation.

To be able to compare the results obtained from the relaxation and creep tests, a generalized Maxwell rheological model was used (Figure 10). First, the parameters of the model were determined for each creep test. Then, with these parameters, the stress relaxation test was simulated using:

$$\sigma(t) = E_{\infty} \epsilon_0 + \sum_{i=1}^N E_i \epsilon_0 \exp\left(-\frac{t}{\tau_i}\right) \quad (3)$$

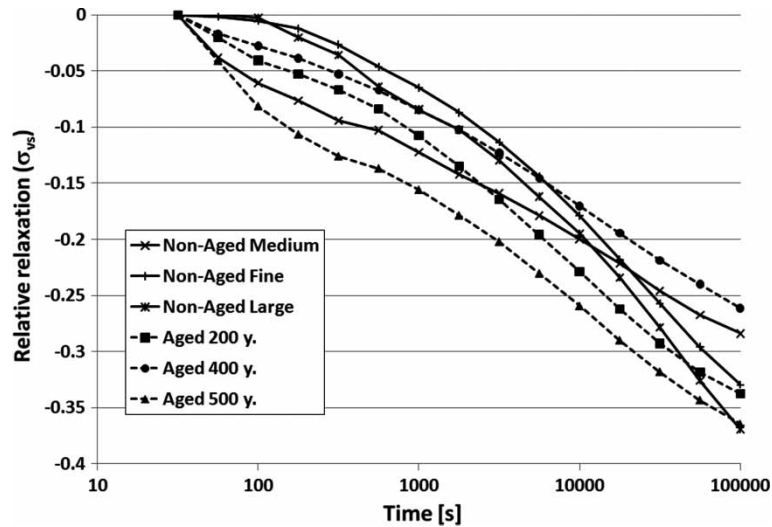

Figure 8. Radial relative relaxation stress (σ_{VS}) versus the log of time under climatic conditions of 22% relative humidity.

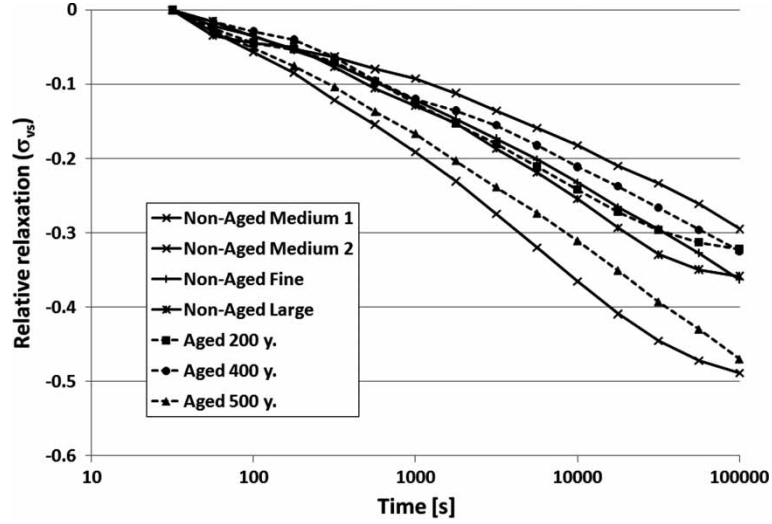

Figure 9. Radial relative relaxation stress (σ_{vS}) versus the log of time under climatic conditions of 76% relative humidity.

where ε_0 is the constant strain during the relaxation, N is the number of spring-dashpot pairs of the model (here $N=5$), E_i are the modulus of elasticity of the springs, t is time and $\tau_i = E_i/\eta_i$ are relaxation times, with η_i the viscosities of the dashpots.

The comparison under dry conditions of creep and relaxation is shown in Figure 11. It can be seen that creep and relaxation gave similar results.

Mechanosorptive tests

The mechanosorptive effect in the radial direction is shown in Figure 3. The total strain ε is shown, and the strain minus the free hygral deformation is shown with a dotted line. This last strain corresponds to the elastic, viscoelastic and mechanosorptive strains. Different strain and relative strain values are listed in Table II.

Comparing the relative mechanosorptive strain (relative to the instantaneous strain ε_0) of the different samples, it can be seen that no significant change occurred during ageing. The relative mechanosorptive strain seemed to be slightly higher

for the non-aged than for the aged woods. These slight modifications could come from a hygroscopic loss due to ageing instead of a change in the mechanosorptive behaviour. However, no significant change in the moisture behaviour of aged wood has been reported (Gereke *et al.*, 2009).

On the other hand, the irreversible relative mechanosorptive strain ε_{irr} , which had not been recovered at the end of the test, was clearly greater for the two aged woods. This indicates that aged wood may undergo more non-recoverable deformation than non-aged wood.

Optical and electron microscopy

Both the chemical composition and the structural parameters of wood influence its strength and stiffness in the radial direction. Annual ring width, latewood and earlywood ratio, compression wood content, ray size and number, degradation by microorganisms and UV light radiation should not be neglected. The basic idea behind the microscopy investigations was to investigate the

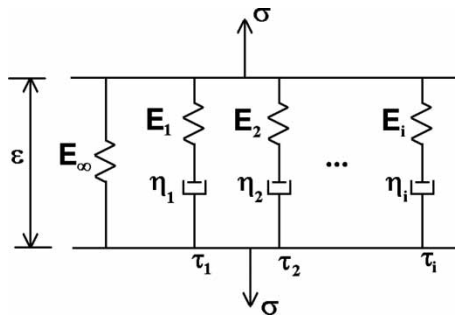

Figure 10. Generalized Maxwell rheological model. E_i = Young's modulus of each spring; η_i = viscosity of each dashpot; τ_i = relaxation time of each spring/dashpot branch.

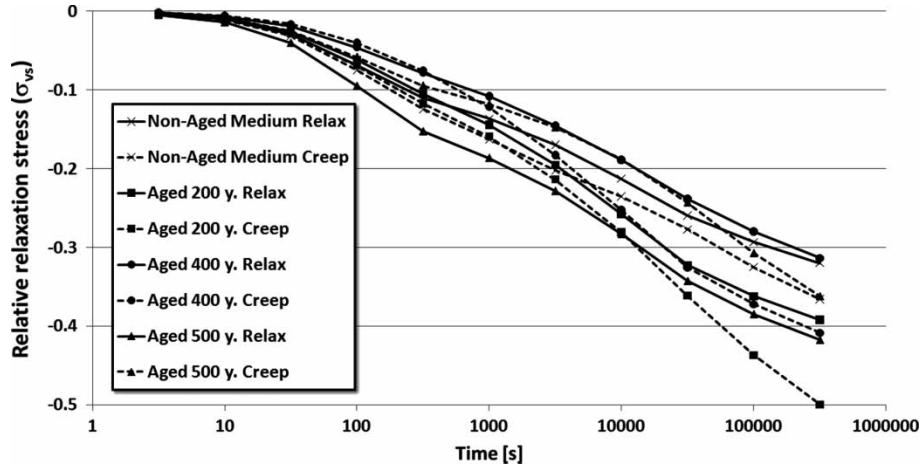

Figure 11. Comparison between relaxation and calculated creep tests under 76% relative humidity. Results were obtained by simulation of a stress relaxation using a generalized Maxwell model (Figure 10).

correlation between the ageing of the wood and the modifications to the microstructure and mechanical characteristics.

The micrographs in Figures 12–14 show cross-sectional cuts of wood. The following damage can be seen in the aged wood structure:

- punctual degradation of the middle lamella (Figure 12)
- delamination of the S3 wall (Figure 13)
- cracking from the tertiary wall into the secondary wall
- delamination within the secondary wall
- delamination between the middle lamella and secondary wall
- radial cracking in the secondary wall (Figure 14)
- partial reduction of the cell-wall thickness within the cell
- accumulation of defaults in the first rows of the earlywood.

It is known that such damage is mainly caused by sample preparation (Wälinder *et al.*, 2009). Indeed, the cutting into fine slices and the drying of the samples can induce quite high local stresses. How-

ever, no such damage was seen in the non-aged wood structure. That shows that the structure of the aged wood has become locally weaker than the non-aged wood. Moreover, similar damage was seen in optical and electron micrographs with different sample preparation.

The localized damage that can be seen in the aged wood structures may partly explain why the strength in the radial direction is lower than that of non-aged wood. Indeed, this localized damage should decrease the failure stress, specifically when the damage is located in the earlywood region.

Nevertheless, these types of damage should not have an important influence on the overall macrobehaviour, such as Young's modulus or viscoelastic behaviour. It is important to note that it is not possible to say which of these changes are correlated with ageing, degradation due to time, low temperature or humidity.

As already stated, the failure of wood in radial direction occurs mainly in the first rows of the earlywood. Thus, any defects in this region will have a direct impact on the strength of the wood in the radial direction. Modifications or defects in the latewood regions are probably less important for the

Table II. Mechanosorptive strain.

	Non-aged wood medium	Aged wood 200 years	Aged wood 400 years
ε_0	0.10	0.13	0.08
$\varepsilon_{ms, c1}$	0.37	0.50	0.26
$\varepsilon_{ms, c3}$	0.40	0.60	0.28
ε_{irr}	0.10	0.19	0.09
$(\varepsilon_{ms, c1} - \varepsilon_0)/\varepsilon_0$	2.88	2.74	2.35
$(\varepsilon_{ms, c3} - \varepsilon_0)/\varepsilon_0$	3.16	3.48	2.68
$(\varepsilon_{irr} - \varepsilon_0)/\varepsilon_0$	0.03	0.42	0.16

Note: ε_0 = instantaneous strain; $\varepsilon_{ms, c1}$ = strain after one cycle of relative humidity (RH); $\varepsilon_{ms, c3}$ = strain after three cycles; ε_{irr} = final irreversible mechanosorptive strain after the final two RH cycles. Finally, each strain value is given relative to the instantaneous strain.

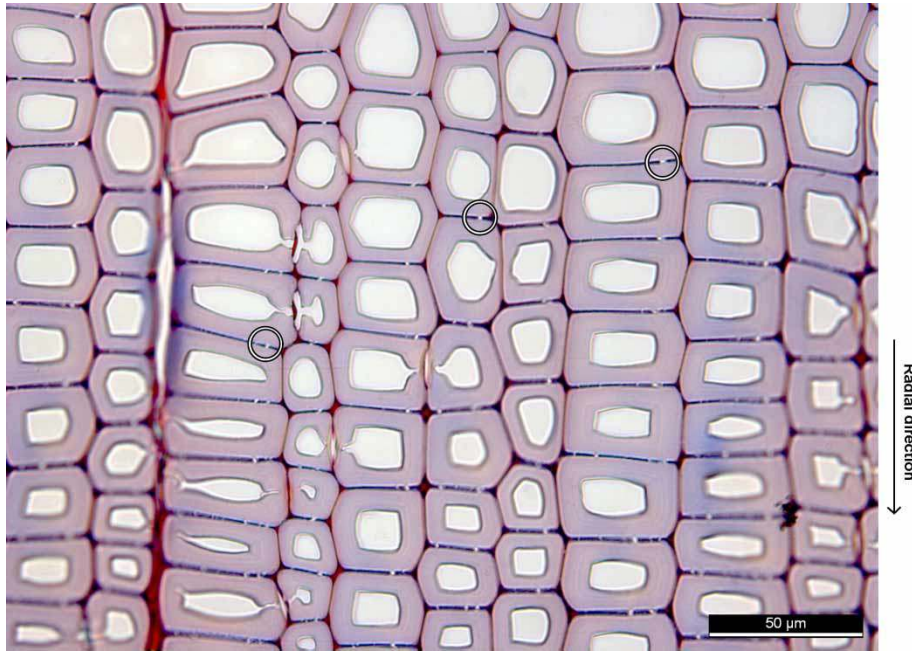

Figure 12. Optical micrograph of 200-year-old aged wood. Punctual degradations are visible in the middle lamella (circled).

failure strength. Because the 400-year-old wood sample had a relatively high strength value, the cell-wall thickness of the earlywood region of the different wood samples was measured. In Table I the values (mean of 60 measurements) are compared with the other samples. The cell-wall thickness of the earlywood region of the 400-year-old wood sample is 5.1 μm, which is 40% higher than that of the non-aged sample. The amount of measurement compared with the amount of cell is low, but since the weakest section determines the strength, the mea-

sured cell-wall thickness may indicate the reason for the higher strength of the 400-year-old wood sample.

Conclusions

The test results indicate that wood properties in the radial direction are quite stable over time. Indeed, several centuries of ageing showed no clear tendency for changes in the mechanical properties such as Young's modulus, or viscoelastic and mechanosorption parameters. Concerning viscoelasticity, it seems

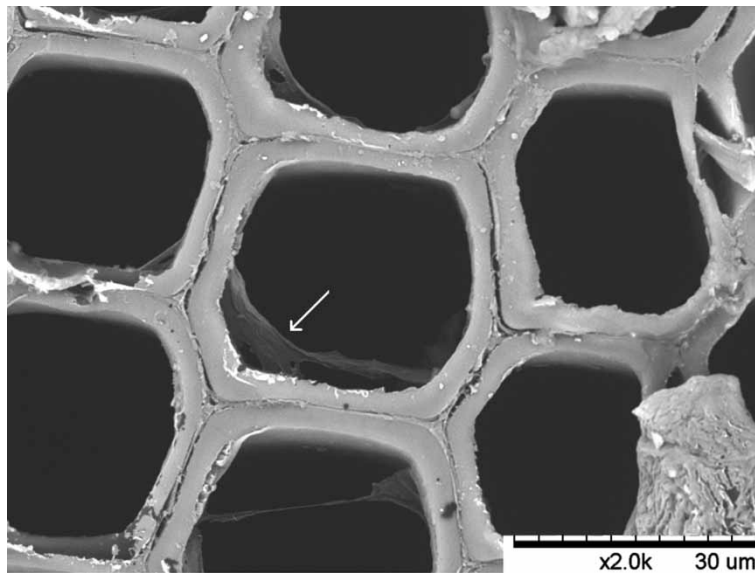

Figure 13. Scanning electron micrograph of 500-year-old aged wood. Delamination of the S3 wall from the secondary wall is visible (arrow).

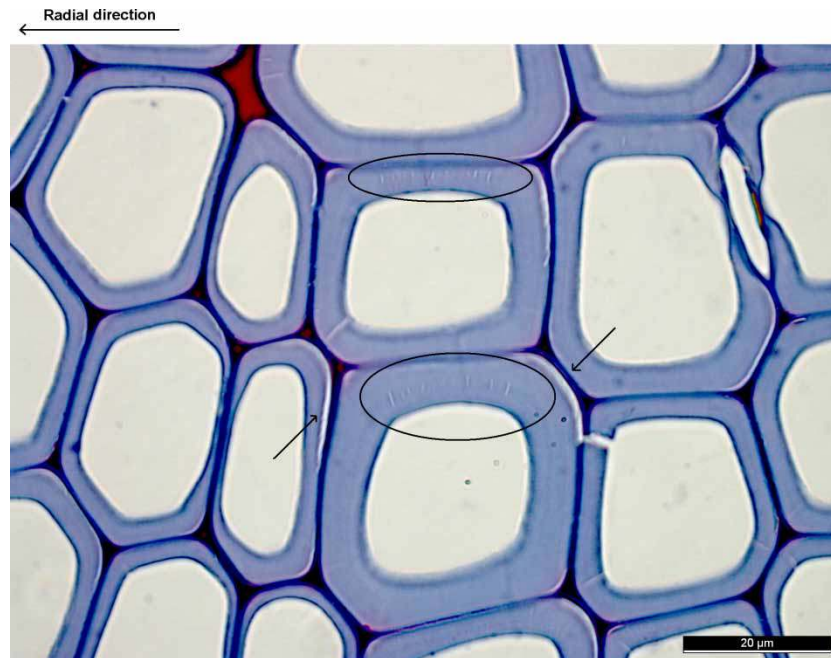

Figure 14. Optical micrograph of 200-year-old aged wood. Delamination between the middle layer and the secondary wall (arrows) and radial cracking in the secondary wall (circled) are visible.

that non-aged wood is a little less viscous than aged wood. However, the fracture parameters in the radial direction were severely degraded after ageing of 200 years. In addition, in terms of mechanosorptive behaviour, the irreversible deformation was significantly greater for the non-aged samples, which indicates a certain degradation of the wood. However, no correlation with time could be determined to quantify the ageing. The ageing depends on many aspects of the thermal, hydral and load history of the wood pieces, which are difficult to know precisely. Indeed, the modification of the wooden components of a sample used only indoors will be different from samples that were used for a roof construction, for example. Moreover, the size of the wooden piece should not be neglected in attempting to understand the ageing phenomenon: a framework beam of 20 cm thickness will have completely different moisture dynamics from that of a parquet floor of 2 cm thickness.

Acknowledgement

The financial support of the Swiss National Science Foundation (FNS) for the project (no. K21K-122336/1) is acknowledged with gratitude.

References

- Burgert, I., Bernasconi, A. & Eckstein, D. (1999). Evidence for the strength functions of rays in living trees. *Holz als Roh- und Werkstoff*, 57, 397–399.
- Burgert, I., Eckstein, D. & Bernasconi, A. (2000). The strength and volume fraction of rays in trees subjected to radial tensile stress. *Plant Biomechanics 2000 Proceedings* (pp. 413–419). Stuttgart: Thieme.
- Erhardt, D. & Mecklenburg, M. (1995). Accelerated vs natural aging: Effect of aging conditions on the aging process of paper. *Material Issues in Art and Archaeology IV*, Cancun, Mexico, May 16–21, 1994 (Vol. 352, 247–270). Warrendale, PA: Materials Research Society.
- Erhardt, D., Mecklenburg, M. F., Tumosa, C. S. & Olstad, T. M. (1996). New vs old wood: Differences and similarities in physical, mechanical, and chemical properties. *ICOM Preprints, 11th Triennial Meeting*, Edinburgh, UK (Vol. 2, pp. 903–910). Paris: ICOM
- Gereke, T., Anheuser, K., Lehmann, P. & Niemz, P. (2009). Moisture behavior of recent and naturally aged wood. *International Conference on Wooden Cultural Heritage: Evaluation of Deterioration and Management of Change, COST Action IE0601 Workshop*, Hamburg, Germany, October 7–10, 2009.
- Kohara, J. (1952). Studies on the durability of wood I: Mechanical properties of old timbers. *Bulletin of Kyoto Prefectural University*, 2, 116–131. (In Japanese.)
- Kohara, J. (1953). Studies on the durability of wood V: Shrinkage and swelling of old timbers of 300–1300 years old. *Bulletin of Kyoto Prefectural University*, 5, 81–88. (In Japanese.)
- Kollmann, F. (1951). *Technologie des Holzes und der Holzwerkstoffe* (2nd ed). Berlin: Springer.
- Navi, P., Pittet, V. & Plummer, C. J. G. (2002). Transient moisture effects on wood creep. *Wood Science and Technology*, 36, 447–462.
- Obataya, E. (2007). Characteristics of aged wood and Japanese traditional coating technology for wood protection. *Acte de la journée d'étude Conserver Aujourd'hui: Les "Vieillissements" du Bois, Cité de la musique*, pp. 26–44.
- Obataya, E. (2009). Effects of ageing and heating on the mechanical properties of wood. *Wood Science for Conservation of Cultural Heritage, Proceedings of the International Conference*

held by COST Action IE0601, Florence, Italy, November 8–10, 2007, (pp. 16–23).

Pittet, V. (1996). Etude expérimentale des couplages mécanosorptifs dans le bois soumis à variation hygrométriques contrôlées sous chargements de longue durée. Thèse doctorale, no. 1526, Ecole Polytechnique Fédérale de Lausanne, Switzerland.

Wälinder, M., Omidvar, A., Seltman, J. & Segerholm, K. (2009). Micromorphology studies of modified wood using a surface preparation technique based on UV-laser ablation. *4th European Conference on Wood Modification*, Stockholm, Sweden, April 27–29, (pp. 103–110).