



**HAL**  
open science

**Evaluation of the Underwater Fleet Simulator MASIM  
and description of simulation results. This simulator has  
been developed during the European project  
Feednetback (Grant agreement n° 223866)**

Jan Opderbecke, Romain Piasco, Jonathan Dumon

► **To cite this version:**

Jan Opderbecke, Romain Piasco, Jonathan Dumon. Evaluation of the Underwater Fleet Simulator MASIM and description of simulation results. This simulator has been developed during the European project Feednetback (Grant agreement n° 223866). [Research Report] GIPSA-lab. 2011. hal-00784543

**HAL Id: hal-00784543**

**<https://hal.science/hal-00784543>**

Submitted on 4 Feb 2013

**HAL** is a multi-disciplinary open access archive for the deposit and dissemination of scientific research documents, whether they are published or not. The documents may come from teaching and research institutions in France or abroad, or from public or private research centers.

L'archive ouverte pluridisciplinaire **HAL**, est destinée au dépôt et à la diffusion de documents scientifiques de niveau recherche, publiés ou non, émanant des établissements d'enseignement et de recherche français ou étrangers, des laboratoires publics ou privés.



## GRANT AGREEMENT N° 223866

<b>Deliverable</b>	D08.04
<b>Nature</b>	Report
<b>Dissemination</b>	Public

**D08.04 – Evaluation of the Underwater Fleet Simulator MASIM and description of simulation results**

<b>Report Preparation Date</b>	28/11/2011 Project month: 39
--------------------------------	---------------------------------

<b>Authors</b>	Jan Operbecke, P06 – Ifremer Romain Piasco, P06 – Ifremer Jonathan Dumon, P01 – INRIA
----------------	---

<b>Report Version</b>	V01
<b>Doc ID Code</b>	Ifremer_D08.03_24032011_V01

<b>Contract Start Date :</b>	01/09/2008
<b>Duration :</b>	41 months
<b>Project Coordinator :</b>	Carlos CANUDAS DE WIT, INRIA, France



---

Projet UE-FP7 FeedNetBack

# Evaluation of the Underwater Fleet Simulator MASIM and description of simulation results

## CONTENTS

<b>1. SCOPE AND STRUCTURE OF THE DOCUMENT .....</b>	<b>5</b>
<b>2. REFERENCE DOCUMENTS .....</b>	<b>5</b>
<b>3. SECTION I : CASE STUDY SUMMARY AND GENERAL CONCLUSIONS .....</b>	<b>6</b>
3.1. Case study and problem statement.....	6
3.2. General concept .....	7
3.3. Interrogations .....	9
3.4. Technical comment of a simulation .....	9
3.5. The FeedNetBack simulator .....	10
3.6. General conclusions .....	11
3.7. Perspectives.....	11
<b>4. SECTION II TEST REPORT OF CONTROL ALGORITHMS .....</b>	<b>12</b>
4.1. Context of this document .....	12
4.2. Scenario description.....	12
4.3. Control Algorithm description.....	12
4.3.1. Local algorithm for AUV stabilization.....	13
4.3.2. Circular formation loop .....	13
4.3.3. Gradient search algorithm .....	13
4.3.4. Definitions of variables and metric.....	13
4.4. Constraints on communication.....	13
4.4.1. Data loss calculation.....	13
4.4.2. Data loss calculation and problem of multipath .....	15
4.4.3. Standard TDMA protocol.....	16
4.4.4. Modified TDMA protocol for channel subject to data loss .....	16
4.4.5. Modified TDMA protocol for network 2.....	17
4.4.6. Improvements from OFDMA protocol.....	17
4.4.7. Delay of propagation .....	18
4.5. Study on parameters.....	18
4.5.1. Local control parameters .....	18
4.5.2. 6.2. Formation algorithm parameters Kappa and beta.....	18
4.5.3. 6.3. Nominal speed of AUV $V_0$ .....	18
4.5.4. Speed of the formation $V_f$ .....	19
4.5.5. Filter on the search direction $\Theta_f$ .....	19
4.5.6. Radius of the formation $R$ .....	19
4.5.7. Optimum number of repetitions $M_2^*$ for loop 2 .....	21
4.6. Study on Number of agents.....	22
4.6.1. Analytical proof of formation's convergence.....	22
4.6.2. Cost of an agent .....	22
4.6.3. 7.3. Number of agent and available bandwidth .....	23
4.7. Key results .....	23
4.7.1. Quite favorable communication conditions.....	23
4.7.2. Quite difficult communication conditions .....	24

4.7.3.	Conclusion for the scenario .....	27
4.8.	Other algorithms for practical implementation .....	27
4.8.1.	Anti collision algorithm.....	27
4.8.2.	Survey algorithm for first phase of the mission.....	27
4.8.3.	Depth management .....	28
4.8.4.	Radius management.....	28
4.8.5.	Speed of formation Vf management.....	28
4.8.6.	Displacement of the ASV .....	28
4.8.7.	Gradient search for one single AUV .....	28
4.8.8.	Use limited embedded energy consideration.....	28
4.8.9.	Use mean and variance for metric .....	28
4.9.	Annex 1 : parameters for simulation : init_simulation.m .....	29
4.10.	Annex 2 : Acoustic communication calculation .....	34
4.11.	Annex 3: Other table of results .....	35
4.12.	Bibliography .....	37
<b>5.</b>	<b>SECTION III RESULTS OF SINGLE NETWORK SIMULATIONS.....</b>	<b>38</b>
5.1.	Overview.....	38
5.2.	Catalogue of simulated configurations and results .....	38
5.2.1.	Data loss and repetitions.....	39
5.2.2.	Radius and number of agents.....	41
5.2.1.	Radius and data loss .....	43
5.2.2.	Speed of formation .....	44
5.2.3.	Number of agents.....	46
5.2.4.	Speed of vehicles.....	48
5.2.5.	Radius with a source 10 times larger.....	50
5.3.	Conclusions.....	52

## 1. Scope and structure of the document

This document is the final deliverable to workpackage 8 – *underwater investigation with a networking fleet of underwater vehicles* – of the FeedNetBack project.

The aim of this document, which is the final deliverable D8.04 to the is to present the evaluation of the Underwater Fleet Simulator MASIM and results produced with this software tool.

The document is structured in three major parts:

- the case study scenario and the technical approach to its solution are presented in section I – this section contains as well as the global conclusions from the two sets of simulations below;
- simulation results produced by partner P06 configured for a single TDMA communication network (AUV-to-AUV and AUV-to-ASV links in a unique network scheme) are described and listed in section II;
- simulation results produced by partner P01 configured for a double TDMA communication network (AUV-to-AUV and AUV-to-ASV links in separate networks) are described and listed in section III;

## 2. Reference documents

- **DOW** – FeedNetBack Project, *Annex 1 - Description of work*, FeedNetBack consortium, 07/02/2008
- **D08.01** – *Evaluation of the Underwater Fleet Simulator MASIM and description of simulation results Networking Underwater Vehicle Fleets – a Case Study*, J. Opderbecke et al., Document Ifremer DOP/DCM/SM/PRAO/09-09315/05/2009
- **D08.02** – *Tools for Underwater Fleet Communication*, J. Opderbecke (Ifremer) et A. Kibangou (INRIA), Document Ifremer DOP/DCM/SM/PRAO/10-307, 03/08/2010
- **D08.03** – *Description of the multi-vehicle simulator*, J. Opderbecke (Ifremer) et J. Dumon (INRIA), Document Ifremer IMN/SM/PRAO/11-091, 25/03/2011

### 3. Section I : Case study summary and general conclusions

#### 3.1. Case study and problem statement

One of the aims of the *FeedNetBack* project is to apply the concepts of network control to the field of multiple vehicle underwater investigation.

Descent into the ocean depths has been a **dream for mankind** for most of the past centuries. Only in the 20th century technology provided means to enlarge the access to the underwater world beyond the depth that a human diver can reach. Pressure and darkness make the ocean a hostile environment - given the impenetrable character of sea water for radio signals, it is easier to communicate with a space shuttle thousands of km away, than with a submersible a few hundred meters below the surface.

Until the 1960ies, the aim was to take human operators to **big depth**, and then to carry out intervention tasks of scientific or industrial nature in the deep sea environment. In a second time the production of visual images, sediment samples and environmental measurements became possible; and from that point on robots – mainly cable operated – were developed. Industrial, military and scientific applications grew and called for varieties of instrumentation, tools and vehicle types – today the underwater investigation is largely based on sophisticated **multi-sensor platforms** allowing systematic coverage of an area with multiple instruments like high resolution bathymetry, sediment profiling, optical images, water probes or even mass-spectrometers.

**Autonomous** underwater vehicles called AUV are amongst the most advanced robot systems in this field: AUV are non supervised robots, equipped with a control and decision making system, with on-board energy sources, navigation systems, and acoustic communication devices – AUV are capable of carrying out complex dive programs with multiple instrumentation packages without a physical link to the surface vessel.

While today the majority of operational dives are carried out to produce maps in a pre-defined geographical ‘box’, a growing need is observed for tools and techniques that give an ability to **search and localize** small scale phenomena in the vast and often monotonous extents of sea-bottom. This last case involves intelligent behavior in the way an underwater vehicle senses and reacts to its observations.

In order to accomplish complex tasks of environmental assessment in an unknown environment, today’s research in underwater robotics often emphasizes on cooperating. Several advantages can be identified with robot fleets like spatial distribution of sensors and resources and optimization of ship time and expense.

The coordination of the vehicles in a team is encountering a major difficulty in terms of communication: in fact, data exchange between AUV via **acoustic links** is subject to considerable delay, a low bandwidth and the risk of packet loss.

The *FeedNetBack* project addresses the coordination problem by considering the AUV team as a **mobile sensor network** and by applying techniques from network distributed control theory to a scenario of a team of AUVs programmed to localize a source of sweet water in a coastal area. It is easily understood that a team of vehicles is able to accomplish spatial sampling at an extent that would increase the traveled distance and duration of a single vehicle in a significant way. The

sampling of a time-varying field of substance concentration can even be considered impossible for a single vehicle.

In ocean sciences, a major scientific impact is given by **hydrothermal vents**. These sources of hot water, and high concentrations of gas and liquid chemical elements, are key sites to geophysical and biological enquiries. Such vents have been found on the slopes of continental margins, and on inter-continental ridges like the mid-Atlantic ridge. In coastal areas, underwater sweet water sources and rivers retain scientists' interest. All these phenomena can be described by a plume of decreasing concentration of an observable chemical element or physical quantity. Such a plume has a typical extent of several kilometers, it has a complex shape that is exposed to ocean currents and varies with time.

Owners and operators of AUV and possibly of AUV fleets, like Ifremer, clearly identify a number of **requirements**, in order to making the idea of AUV fleets a realistic approach:

1. given the day rate of AUV operation between 1 000€ and 10 000€ depending on size and equipment, the number of vehicles is a key criterion; the project studies are conducted with a number of two to five AUVs; the AUV fleet is composed of identical vehicles in order to optimize the operator team structure and strength;
2. the AUV team is self-organizing, a failure of one of the systems is compensated automatically; a coordinating surface vehicle ASV can optionally be envisaged.
3. the communication network based on underwater acoustic links is based on today's available –on-the-shelf technology; the fleet control must be robust with respect to the performance of the underwater communication network, which is characterized by a single emission slot at a time.

### 3.2. **General concept**

The case study focuses on the localization of a source diffusion of substance in the sea water– this can be a hydrothermal vent, a sweet water source, a pollutant spill etc. The concentration of a substance or a physical parameter (e.g; salinity) is measured by an instrument on each of the autonomous underwater vehicles (AUV). The turbulences and the low level of spatial variation of the measurement at increasing distance from the source makes it impossible to estimate a gradient from the measurements taken by a single vehicle. A communicating and **cooperating fleet of AUV** allows determining the concentration gradient and carrying out a search procedure in order to localize the source.

A particular constraint in this application is the underwater communication based on acoustic signals: small bandwidth, risk of packet loss, delays related essentially to the sound velocity of about 1500m/s.

For this case study we will consider a **plume of low salinity water** diffusing from an underwater sweet water source. The environment model describing the diffusion plume has to reflect the turbulent character of the diffusion phenomenon. Like clouds of smoke moving upwards from a source location, the plume has irregular shape and drifts laterally due to sea currents. The salinity within the plume is increasing with growing vertical and horizontal distance from the source.

In this context, a gradient computed from a series of measurements obtained on a single vehicle do not allow gradient estimation – a wider spatial extent of the measurement points is the key character of the multi-vehicle approach.

Furthermore, the gradient descent in the turbulent environment is a non convex search problem. The filtering effect of the multi-vehicle sensor network enhances the performance of the maximum search.



The system of our control problem is given by a **fleet of two to five** autonomous underwater vehicles, and optionally a supervising autonomous surface vehicle ASV. The communication network is based on acoustic data transmission under the hypothesis that only one vehicle can emit at a time, and that all vehicles receive the data from all other vehicles in the fleet.

In a configuration where no ASV is present, the fleet is self-organizing and automatically adjusts to the number of active AUVs. Every vehicle transmits its localization and its salinity measurement to the other members of the fleet.

The fleet is moving in a circular formation at slow speed; the center of the circle being drawn towards the source location by the gradient descent algorithm. In terms of control theory, the team members reach a consensus of circle center and search direction.

In order to accomplish a solution to the search problem, the control architecture is designed on three levels:

**a. vehicle control**

The trajectory and dynamics of the individual AUVs are controlled via a classical low level controller; this controller only uses feedback measured on the vehicle itself. The AUV kinematics are described by a hydrodynamic model with six DOF. The control actuators are a single thruster at the tail of the vehicle, and five control fins, two placed in on each side in the front section of the vehicle and three in an inverse Y configuration in the tail. This allows for full control of vehicles when stabilizing the circular formation. The FeedNetBack solution investigates a controller that focuses particularly on the stability and the robustness of the maneuvering AUV.

**b. formation control**

The geometric formation of the fleet of AUVs is controlled taking into account the position of a vehicle relative to the other team members, and a center position of the formation. This control level is a distributed control loop, with position and formation parameters exchanged through the acoustic network. The way and quantity of data exchange over the acoustic network is a key to the successful control of the formation. Loss and delay of information in the network are factors that may cause divergence in the mutual perception and control of the formation. In this study, the AUV team runs on a circular shape formation.

**c. Communication model**

Acoustic modems in the state-of-the-art, do not allow sending and receiving simultaneously. This simple rule results in a networking communication scheme where each vehicle has a fixed time slot to send, and for the remaining time slots in a complete cycle listen to the other members of the team.

Acoustic data transmission is characterized by very small bandwidth compared to radio or wire transfer. Packet loss caused by vehicle and environment noise as well as multipath and reflection phenomena.

**d. gradient climb**

the team being brought and hold in a defined formation at the previous level, the next step is to exchange the environmental sensor data and implement the estimation of the concentration gradient. The maximum concentration is reached by following the gradient. Like the formation control, we face here a distributed problem with sensor data from all the team members exchanged through the acoustic network. The computation may differ from one vehicle to another. The turbulent aspect of the concentration plume, and the requirement for a wide spatial base for the gradient computation, translate by the need for a robust search algorithm.

#### **e. consensus algorithm**

The possibility of incomplete and thus different information available on the different vehicles exists at the fleet control level as well as that of gradient climb. A computational mechanism is required whose role is to hold the team together and make the formation move on a unique center trajectory. A consensus algorithm has been designed specifically for the task of ensuring that the formation shape and trajectory on all team members converge.

### **3.3. Interrogations**

Source localization with a fleet of underwater vehicles is a novel solution. It faces strong complexity of coordinating a fleet, accomplishing a source seeking strategy, and handling the constraints of communication, sampling and maneuvering of the fleet.

The development and use of fleet simulator does help us reach insight to the following questions:

1. The number of AUVs has strong implication on the investment and running costs, size of the vessel as well as human resources involved: What will be the performance in function of the number of vehicles? Which criteria will aid an operator in choosing the size of an AUV fleet?
2. Which is the implication of shape and geographical extent of a vehicle network? How does the formation depend on the time schedule of the communication network?
3. Is the concept robust with respect to operational considerations like the eventuality of failure of an AUV, communication drop outs, etc. ?
4. What are the limits for fleet formation in terms of communication characteristics?

### **3.4. Technical comment of a simulation**

We have designed a configuration with a fleet of a maximum of five autonomous underwater vehicles, equipped with sensors for a given scalar quantity, here the salinity. The aim is to locate a source of fresh water without human intervention.

A first challenge is due to the difficulty of establishing reliable communication in underwater environment. This is a key point for ensuring an effective cooperation. Indeed the data rate is only of a few hundred bits / s, the transmission delay is around a second and about 10% of items are lost.

A second challenge concerns the monitoring of formations. In this first phase of exploration, the vehicles move in a V-shaped formation. Once an agent detects a significant change in salinity, it transmits this information to the others. Then the fleet enters a phase of consolidation.

We choose cooperation strategies with the pooling of information from each vehicle to exploit the advantages of using a fleet of vehicles and to reduce the time and cost of exploration.

In this phase, the fleet is regrouping into a circular shape. With such formation, the movement is slower than with the V-formation. However, there is a greater flexibility to move in all directions. Also, the distribution of submarines around the circle allows a more precise localization of the source.

It is also possible to envisage other types of formation: the shape can be "elastic", that is, it deforms to adapt to its environment, to follow a path or to avoid obstacles.

To form and maintain this formation, the submarines must exchange messages according to their relative position to the center of the formation. Although exchanges of the data would allow a faster convergence of the fleet to the formation and its better maintenance, only those of the nearest neighbors are actually needed. Finally, this structure is robust to geographic constraints, limited flow and data loss.

In order to fulfill the objective of sources seeking, we developed a decision algorithm. It is also based on data exchanges between neighbors to ensure the same robustness with respect to communications. It must allow all submarines to agree on a direction for the formation to move towards the source.

### **3.5. The FeedNetBack simulator**

#### 3.5.1 Simulation objective

The complex formulation of the problem requires that the implemented control solutions are validated by numerical simulation.

Several parameters at system design level allow evaluating the performance of a multi-vehicle team and the implemented control strategies.

The parameters of system design and environment constraints are:

- number of underwater vehicles and their capabilities in terms of velocity and heading rate;
- the quality of acoustic data transmission resulting in a ratio of packet loss;
- the geometry of the formation, for example the circle diameter, translating by the temporal dimensions of the communication scheme;

#### 3.5.2 The MASIM simulator

Simulation is becoming in this context a design tool for the definition of a multi vehicle system. It allows evaluating the gain in performance and the justification for a chosen number of vehicles – this is of course a primary criterion for the application scenario, each vehicle having considerable “weight” in terms of investment, operating cost and the operator resources involved.

The MASIM simulator is designed to accomplish the design study simulations in accelerated time, and with a simple configuration of the design parameters.

The 3D visualization of the simulation data is a handy tool in a second step to represent the resulting dive features and provide easy understanding of the fleet behavior.

### 3.6. **General conclusions**

First conclusions can be stated at the end point of the FeedNetBack project:

- Maintaining formation and proceeding on a targeted trajectory is possible with a realistic ‘product-based’ acoustic communication link. Up to 50% of packet loss is successfully handled in the ‘worst case’ simulation scenarios.
- With an increasing number of vehicles, the communication cycle duration is also increasing, and the fleet may encounter difficulties maintaining the formation; a number of 3 AUVs seems the ideal fleet size – this is an interesting result with strong potential for practical application.
- The circular shape translates by a low speed of the fleet towards its goal, but it allows adapting easily to changes in direction and amplitude of the fleet movement.

On the level of AUV fleet operation the two following statements are issued and mark the preliminary end point of the project:

1. **It has been successfully shown that the control of a fleet formation with a common mission goal is functioning in realistic conditions; a single frame of control theory enables the networking fleet concept and provides a scientifically founded framework for fleet cooperation.**
2. **The simulations with varying system parameters give insight into the dependencies within the complex system, making the MASIM simulator is a highly valuable tool for the AUV system design in the hands of an AUV operating entity.**

### 3.7. **Perspectives**

In future work, new algorithms for acoustic data transmission will be implemented; techniques already studied in the project, like OFDMA, will increase the effective bandwidth of vehicle-to-vehicle communication and eventually allow multiple-input-multiple-output scenarios.

A second fleet architecture will be implemented which does not include a surface vehicle. The AUV organize without a centralized leader.

## 4. Section II

### Test report of control algorithms

#### 4.1. Context of this document

This document exposes the first tests of control algorithms developed in Feednetback project and applied to underwater exploration by multi-agent systems.

These algorithms have been implemented into the MASim simulator which is coded into Matlab-Simulink software.

A description of the study case's constraints can be found in [D8.01].

A description of the simulator can be found in [D8.03].

#### 4.2. Scenario description

We consider a fleet of AUV and a single ASV.

The number of AUV can be from 2 to 5 and each one has the dynamic behavior of the Ifremer's AUV AsterX.

We fixed the parameter of the fresh water source for all the tests.

We consider 2 initial positions of the fleet.

We also consider the source seeking into a 2D plan, at a fixed depth.

We consider 2 independent underwater acoustic networks:

Network 1 is horizontal one between AUV's.

Network 2 is vertical one between AUV's and ASV at the surface.

We consider that these 2 networks are directive enough in order not to disturb each other.

All parameters can be found in the initialization matlab file `init_simulation.m` in annex 1.

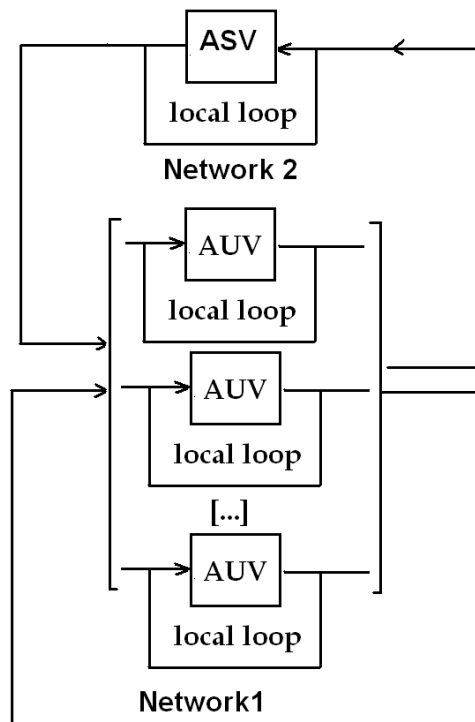

Control architecture of the scenario

#### 4.3. Control Algorithm description

We consider 3 algorithms in cascade.

#### 4.3.1. Local algorithm for AUV stabilization

This algorithm is a robust control of depth, speed and heading.  
Its description can be found in [R1].  
We will call this algorithm “loop0”.

#### 4.3.2. Circular formation loop

This algorithm maintains the fleet into a circular uniform formation. Information is exchanged into network 1 using TDMA protocol.  
Its description can be found in [P1].  
We will call this algorithm “loop1”.

#### 4.3.3. Gradient search algorithm

This algorithm uses each AUV salinity measurement to find the direction of the formation's displacement. This algorithm is implemented into the ASV and information is exchanged into network 2 using an adapted TDMA protocol.  
Description of the gradient search algorithm can be found in [P2].  
Details on implantation and protocol used can be found in [P3].  
We will call this algorithm “loop2”.

#### 4.3.4. Definitions of variables and metric

To evaluate performance let define the following variables:

-dc [m]: distance between the center of the formation and the position of the source.

-Tf [s]: the first time dc is lower than 3m.

-Tm [s]: Tm is the metric used to compare the performance of different scenario.

Tm=Tf – 2000. These 2000s correspond in simulation to the time when we activate loop2 and so the formation starts to move. This is the duration loop1 needs to build and stabilize the formation from the initial position.

-R [m]: radius of the formation

-V0 [m/s]: magnitude of the nominal speed of an AUV

-Vf [m/s]: magnitude's speed of the formation

-Øf [rd]: direction of formation's displacement computed by loop2

-n number of agent

### 4.4. Constraints on communication

#### 4.4.1. Data loss calculation

Acoustic modem performance is calculated from equation given in [D8.01] and literature.

See annex 2 for details of equations used.

We get  $\alpha$  the probability packet loss function of the following parameters:

SL = source level

Nis = ambient noise level

f = nominal frequency

BW= receiver bandwidth

Kb=number of bits / packet

Gamma1 and Gamma2 = modem algorithm performance

R = distance of communication

$adb=0.11*(f^2/(1+f^2))+44*(f^2/(4100+f^2))+2.75*10^{(-4)}*f^2+0.003$

$TL=k*10*log10(R)+adb*R/1000$

$SNRdb=SL-TL-Nis-10*log10(BW)+DI$

$Ps=erfc(sqrt(gamma1.*10.^{(SNRdb/10)}))/2$

Probability of packet loss for a packet of Kb bits :

$$P = \min(1 - (1 - P_{sdb})^{Kb + 0.1}, 1)$$

For network 1, we consider that the maximum distance between AUV is 200m. The probability of packet loss is therefore  $\alpha_1 = 10\%$ . This assumption is valid for  $SL \geq 173 \text{ db ref } 1\mu\text{Pa at } 1\text{m}$  and  $Nis \leq 90 \text{ dbV/sqrt(Hz) at } f$

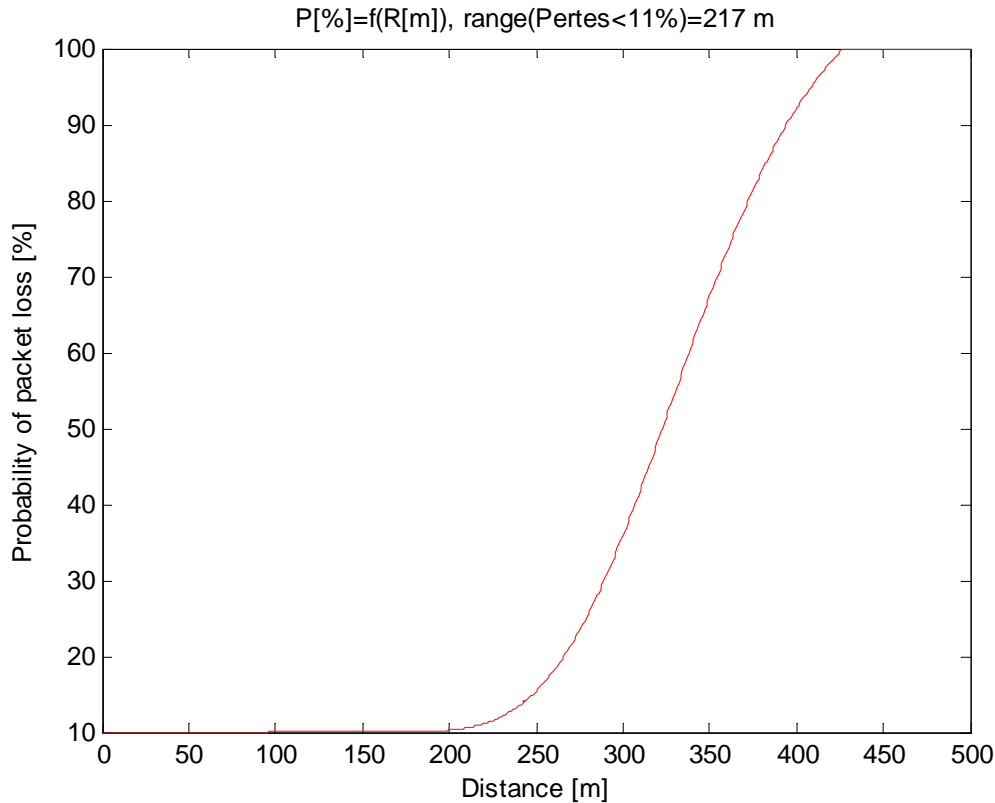

*Network1 : Probability of packet loss for  $DI=2$ ,  $SL=173 \text{ db ref } 1\mu\text{Pa at } 1\text{m}$ ,  $Nis=90 \text{ dbV/sqrt(Hz) at } f$ ,  $BW=239.8833\text{Hz}$ ,  $f=10\text{kHz}$ ,  $\gamma_1=0.246$ ,  $Kb=60 \text{ bits}$ ,  $k=2$*

For network 2, we consider that the maximum distance between AUV is 3000m. The probability of packet loss is therefore  $\alpha_2 = 10\%$ . This assumption is valid for  $SL \geq 185 \text{ db ref } 1\mu\text{Pa at } 1\text{m}$  and  $Nis \leq 75 \text{ dbV/sqrt(Hz)}$

We assume that there is enough energy embedded in ASV to send the acoustic message at a very high level and ensure no loss of data from ASV to AUV.

$\alpha_2$  is therefore only for AUV to ASV communication.

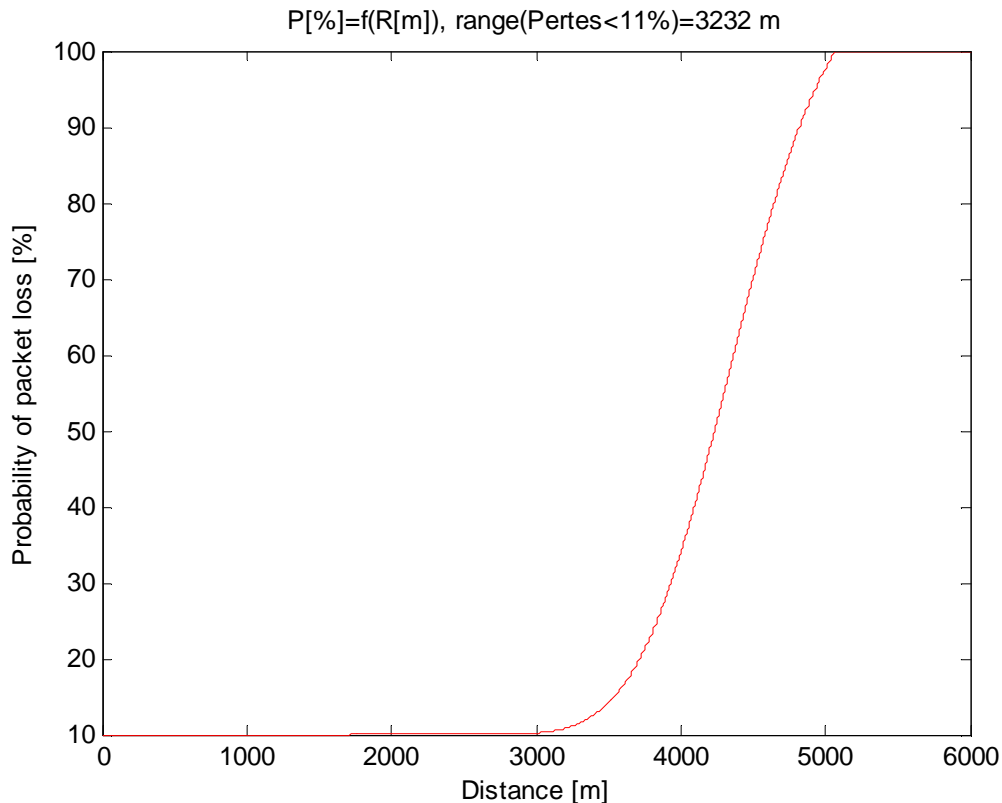

*Network2 : Probability of packet loss for  $DI=2$ ,  $SL=185$  db ref  $1\mu Pa$  at  $1m$ ,  $Nis=75$  dbV/sqrt(Hz) at  $f$ ,  $BW=239.8833Hz$ ,  $f=10kHz$ ,  $\gamma=0.246$ ,  $Kb=60$  bits,  $k=2$*

#### 4.4.2. Data loss calculation and problem of multipath

In some case, the problem of multipath can be neglected and included into the 10% of data loss we add (see part 5.1).

In [D8.01], we can find the following condition:

« 6.2.3. [...] The relative horizontal range between the vehicles are supposed to be greater than five time the relative altitude. »

We can consider that it does in network 2 but not in network 1.

To evaluate communication constraints coming from multipath of acoustic waves, we consider 5 path:

Path 1 : direct

Path 2 : 1 reflection on the surface

Path 3 : 1 reflection on the sea bed

Path 4 : 1 reflection on the sea bed then 1 at the surface

Path 5 : 1 reflection on the surface then one at the seabed



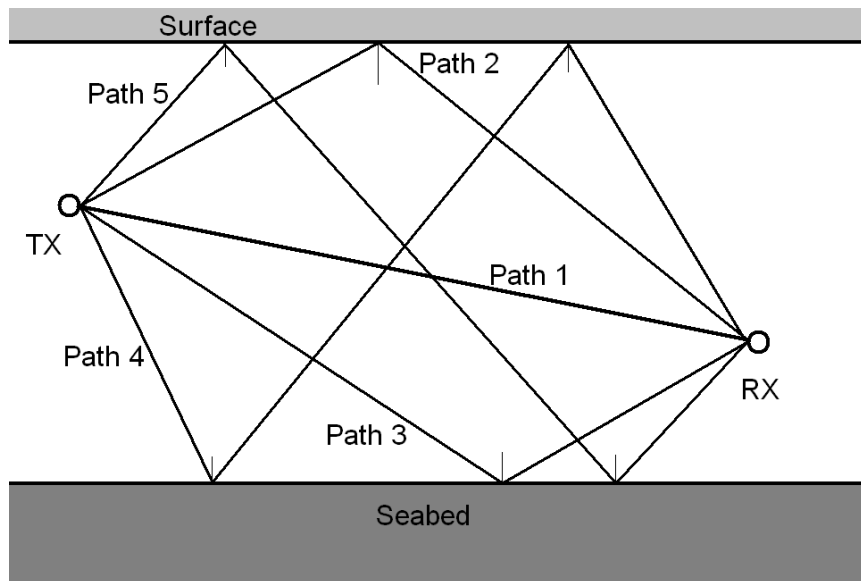

We consider that there is attenuation only for reflection at the seabed.

At this stage of the study, it is considered that multipath effects have a strong influence and significantly increase the rate of packet loss.

#### 4.4.3. Standard TDMA protocol

We didn't find any acoustic modem that could work in duplex mode (see [D8.02]).

For that reason, the TDMA protocol is commonly used to communicate in a network with several nodes.

TDMA (Time Division Multiple Access) consists in divide the time into one slot for each agent communicating on the network.

Let define the following variables:

D: bit rate in bit/s

$L_{max}$ : maximum distance between 2 nodes [m]

Nbits: the number of bit for each message

$V_{sound}=1500$ [m/s] : sound speed

n: number of agents

$T_e=N_{bits}/D$  : emission time [s]

$T_t=L_{max}/V_{sound}$  : maximum travel time of a message [s]

$T_{sl}=T_e+T_t$  : slot time of each agent [s]

$T_c=n.T_{sl}$  : total cycle time of the protocol [s]

The effective cycle time is also modified by the sample rate of AUV: each slot has to be a multiple of the embedded computer's sample time.

#### 4.4.4. Modified TDMA protocol for channel subject to data loss

In our study case, we consider the acoustic channel as a packet erasure channel with erasure probability  $\alpha$ . See part 5.1 for details.

Performances of control algorithm that uses this type of channel decrease with  $\alpha$ .

We choose to use the repetition technique proposed in [P3] to adapte the standard TDMA protocol.

The idea is that each agent will send his message M times instead of one.

The probability of erasure will be  $\alpha^M=\alpha^M$  and total cycle time  $T_c=n.M.T_{sl}$ .

As in the paper [P3], we can find then the optimum  $M$  that minimizes the metric  $T_m$ .

This protocol is used for loop1 through network1.  $M_1$  will be parameter  $M$  for loop1. Values used in this scenario can be found in annex 1.

#### 4.4.5. Modified TDMA protocol for network 2

The particularity of network 2 is that all AUV are in the same plane and ASV is at the surface. One assumption here is that ASV has enough energy and space to have a powerful emitter that make the ASV→AUV communication without any data loss.

In the case of a centralized algorithm, all AUV has to send a message to ASV and ASV has to send a message to AUV but there is no need that AUV are sending message to each other.

Therefore, we can divide TDMA cycle into 2 phases:

- 1-Each AUV sends his message to ASV one by one
- 2-ASV sends is message to all AUV

Let define the following variables:

D: bit rate in bit/s

$L_{max}$ : maximum distance between AUV and ASV [m]

$dL_1$ : maximum difference between all distances between AUV and ASV [m]

Nbits1: the number of bit for each AUV message

Nbits2: the number of bit for each ASV message

$V_{sound}=1500[m/s]$  : sound speed

n: number of AUV

$T_{e1}=Nbits1/D$ : emission time for AUV [s]

$T_{e2}= Nbits1/D$ : emission time for ASV [s]

$T_t=L_{max}/V_{sound}$  : maximum travel time of a message between AUV and ASV [s]

$T_{s1}=dL_1/V_{sound}$  : security time to avoid collision between 2 AUV messages.

$T_{s11}=T_{e1}+T_{s1}$  : slot time of (n-1) first AUV [s]

$T_{s1e}=T_{e1}+T_t$  : slot time of the last AUV [s]

$T_{s12}=T_{e2}+T_t$  : slot time of ASV [s]

$T_c=(n-1).T_{s11}+T_{s1e}+T_{s12}$  : total cycle time of the protocol [s]

Because  $T_{s1}<T_t$ ,  $T_c$  is  $(n-1).(T_t-T_{s1})$  shorter than standard TDMA.

As network2 is also subject to data loss  $\alpha^2$  (in AUV→ASV communication), we uses the same method describes in 5.3. to compensate this problem.

The total cycle time is now:

$T_c=M_2.(n-1).T_{s11}+M_2.T_{s1e}+T_{s12}$  [s]

See details of this protocol in [P3].

This protocol has been used for loop2 over network 2. See annex1 for detailed values.

#### 4.4.6. Improvements from OFDMA protocol

In OFDMA technique, each agent can use its own band of frequency.

Several agents can therefore send there message in the same time.

As the bandwidth is share between all agents, the bitrate is also reduced.

The simplex constraints remain so a TDMA protocol still necessary but could be reduced to only 2 slots.

For example:

Slot 1 : n-1 first agents send its message and agent n is listening

Slot 2 : agent n sends its message and all it received in slot 1 and others are listening

In loop2 through network2, all AUV will be able to send in the same time.

If we consider that the bitrate is divide by n, we can calculate the new slot time for all AUV:

$$T_{sl} = T_{e1} * n$$

which is (n-1)  $T_{sl}$  shorter than the previous one.

#### 4.4.7. Delay of propagation

For loop1 and loop2, constraint on propagation delay of acoustic waves is included into the principle of TDMA protocol. We don't have to add any extra delay for simulation.

Theses algorithm use information from the network only at the end of each cycle of communication.

### 4.5. Study on parameters

Here is preliminary study to feel what the influence of each parameter is.

#### 4.5.1. Local control parameters

Parameters of loop0 are fixed for all the study. It has no influence on other parameter of the scenario. Its modification can change tracking performance of the depth z, the heading theta, the speed V, and robustness with respect to interference currents or errors of parameters.

Refer to [R1] for more precisions.

#### 4.5.2. 6.2. Formation algorithm parameters Kappa and beta

These parameters have to be set to stabilize the formation by taking into account the dynamic of each agent.

Theses parameters are fixed for all the study (see annexes for values).

However, you'll have to tune it again if you change some parameters of the scenario like R,  $V_0$ ,  $V_f$  or the dynamic of agents.

Basically, Kappa defines the speed of convergence of the radius: each agent converges in a rotation around the center at the defined radius.

Beta defines the speed of convergence of the uniform distribution. This parameter controls the angle between each agent and so uses the information from the communication network 1.

One way to do set these parameters can be:

- fix the center position

- try different values of Kappa to make all agents converges into the circle: plot the radius of each agent to evaluate the optimum value of kappa.

- try different beta to synchronize uniform formation convergence with the radius convergence: plot the angle between each agent to evaluate the optimum value of beta.

Refer to [P1] for more precisions.

#### 4.5.3. 6.3. Nominal speed of AUV $V_0$

AUV AsterX torpedo shape has some dynamics constraints:

$$V_{\max AUV} = 2.67 \text{ m/s}$$

$$\Theta_{\text{taptmaxAUV}} = f(V_{AUV}) \text{ (see following figure)}$$

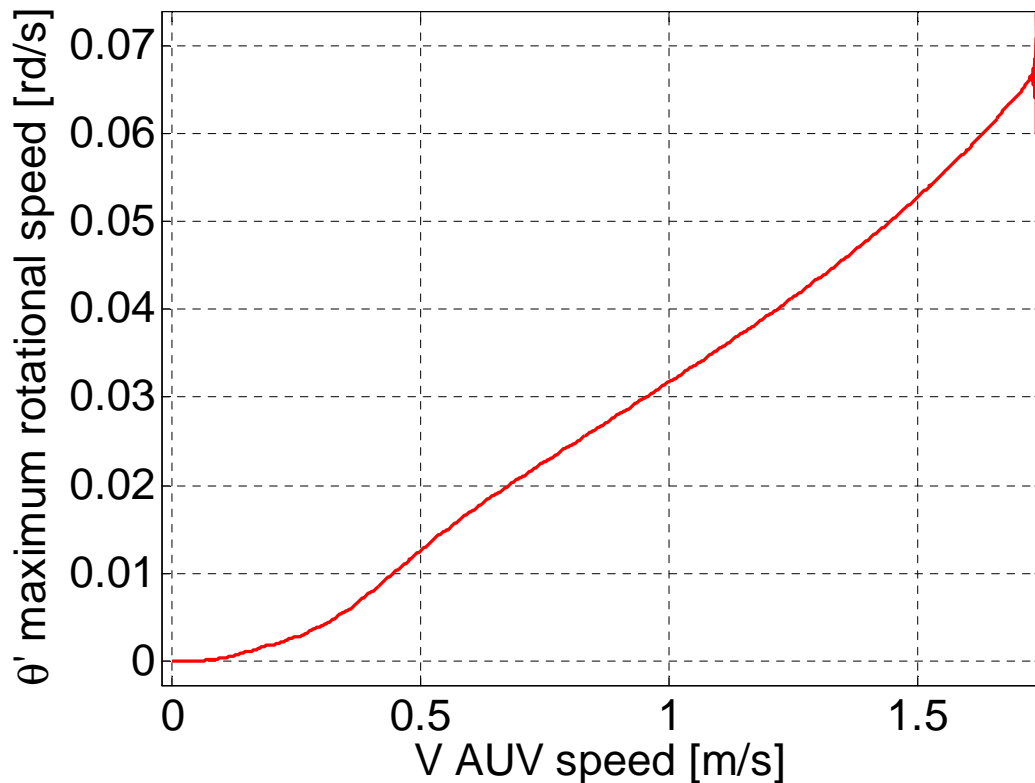

This results the following constraints on  $V_f$ ,  $V_0$  and  $R$ :

$$V_0 + V_f < V_{\max AUV}$$

$$V_0/R < \Theta_{\text{taptmaxAUV}}(V_0 - V_f)$$

To fulfill these constraints, we set the parameter  $V_0$  for all the study (see annex 1 for value).

#### 4.5.4. Speed of the formation $V_f$

During the entire mission, the magnitude of the speed of the formation's center is set to  $V_f$ .

This is a parameter of loop2.

This parameter strongly influences the mission time  $T_m$ .

It has to be set as big as possible but with respect to constraints that has to fulfill  $V_0$ .

Therefore, we increase  $V_f$  until the simulation show too big deformations on the formation during the mission.

#### 4.5.5. Filter on the search direction $\Theta_f$

When the number of agent is low, the search direction  $\Theta_f$  is oscillating around the right value and so add a parasite movement into the formation's trajectory.

Therefore, we implement a filter on the direction search  $\Theta_f$ .

This is a low pass filter of the 1<sup>st</sup> order and its cutting frequency is  $f_c = V_0 / (4/3 \cdot \pi^2 \cdot R)$ .

This corresponds to a time response of the filter equal to one turn for an AUV.

This method is reduction oscillations of the  $\Theta_f$  but not avoid loops describes in part 6.6. because frequency of these loops are lower.

#### 4.5.6. Radius of the formation $R$

Radius can be seen as a spatial sampling for gradient computation.

A big  $R$  is makes the gradient search robust to noise measurement.

A small R makes the gradient search more precise, especially when the variation of salinity is abrupt. When the plume of concentration is thin, a too big R slows down the movement by describing loops.

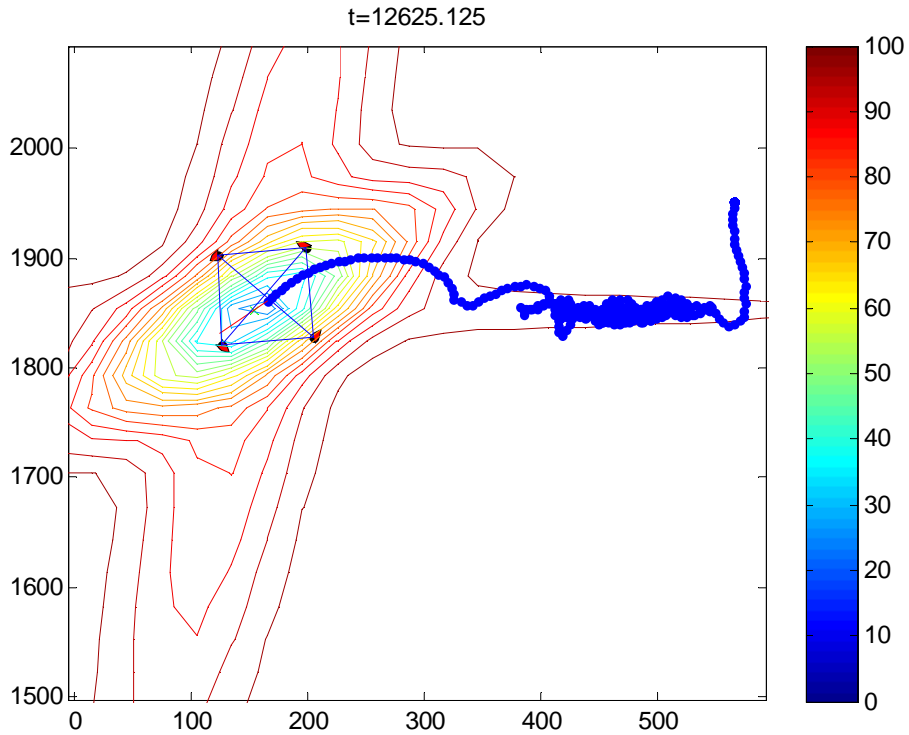

Trajectory of the fleet, 4 AUV, R=50m,  
Vf=0.15m/s,  $\alpha_1=\alpha_2=10\%$  Tt=10706s, filter on  $\Theta_f$

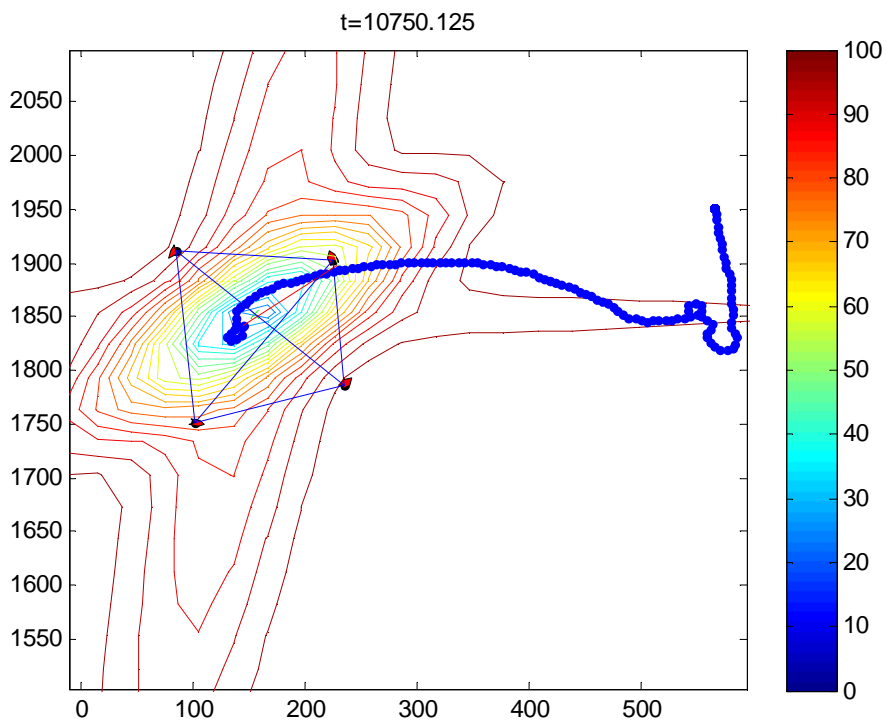

Trajectory of the fleet, 4 AUV, R=100m,  
Vf=0.15m/s,  $\alpha_1=\alpha_2=10\%$  Tt=4827s, filter on  $\Theta_f$

#### 4.5.7. Optimum number of repetitions $M2^*$ for loop 2

$M2$  is the number of repetitions into network 2 to reduce effect of packet loss.

The probability to lose a packet through network is  $\alpha 2^M = \alpha 2^{M2}$ .

To reduce the number of parameters, we can set  $M2$  to an optimum value analytically calculated.

Loop 2 is computing the direction if it receive all the packet from AUVs so the probability to compute the command is  $(1 - \alpha 2^{M2})^{n0}$ .

We can compute the typical number of cycle we need to calculate the command  $N = 1 / (1 - \alpha 2^{M2})^{n0}$

Therefore, as  $M2$  is decreasing this value but increases the cycle time, we can plot the typical time to wait between 2 calculated commands.

For example, we can see in the following figure that  $M2^* = 3$  for 2 AUVs and  $M2^* = 4$  for 4 AUVs.

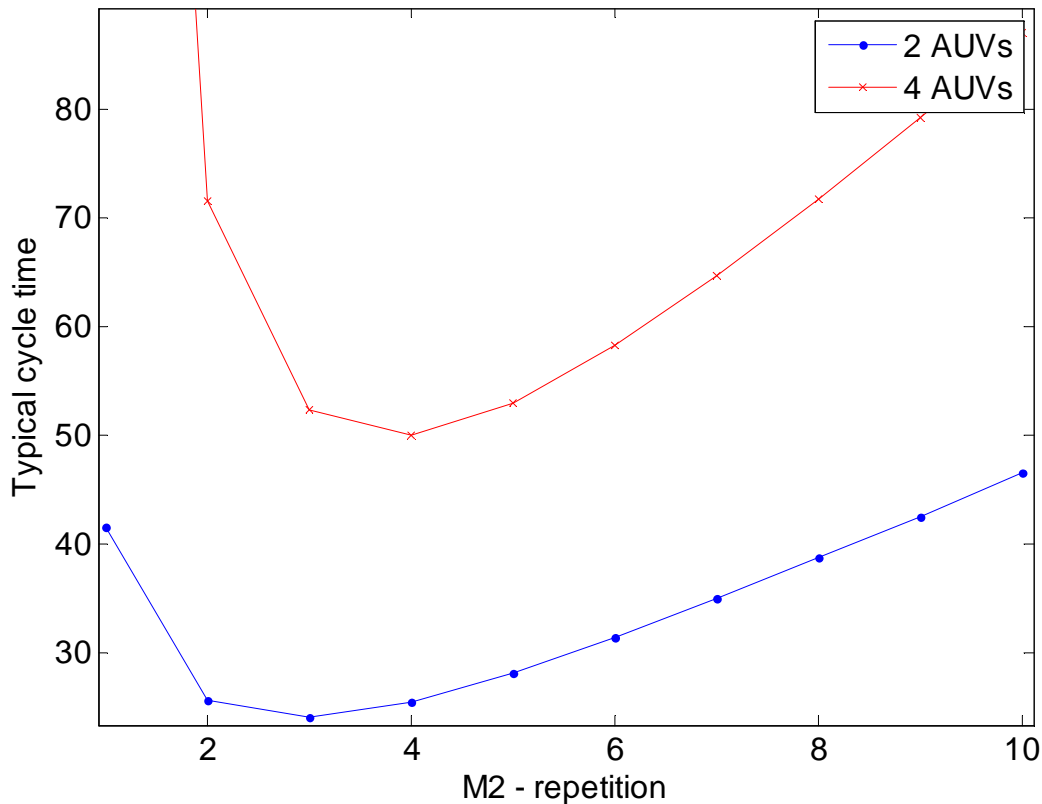

Typical Cycle time for loop 2 for 2 and 4 AUVs,  $\alpha 2 = 50\%$ ,  $nTsAUV = 17$ ,  $nTslastAUV = nTsASV = 33$

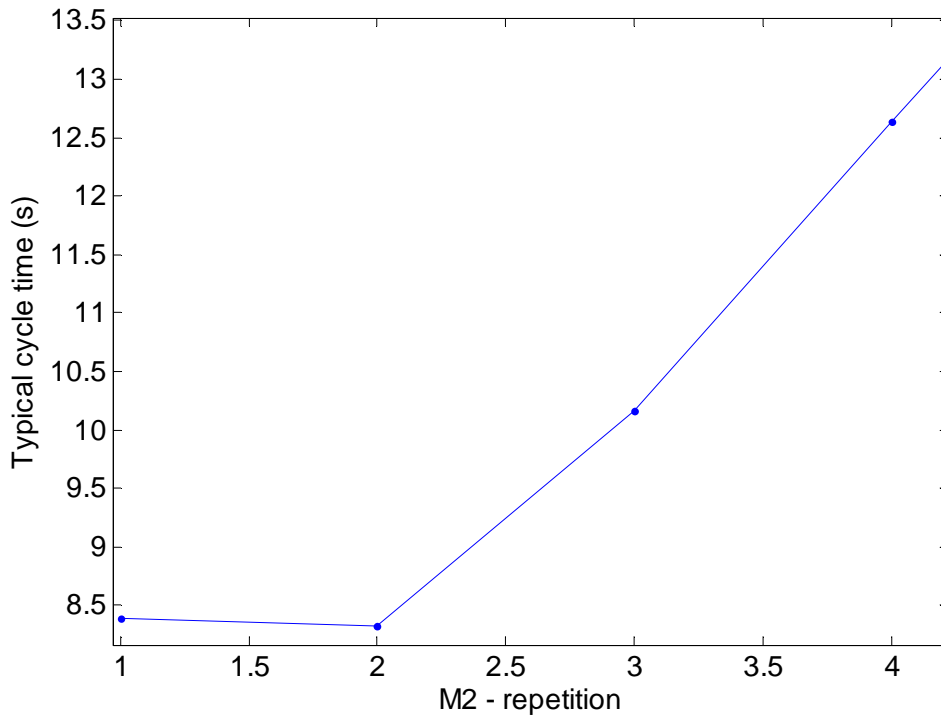

Typical Cycle time for loop 2 for 4 AUVs,  $\alpha_2=10\%$ ,  $n_{TsAUV}=6$ ,  $n_{TslastAUV}=n_{TsASV}=13$

#### 4.6. Study on Number of agents

As the radius, the number of agent into the circular formation can be seen as a spatial sampling for gradient computation: more agents on the circle there is, the better is the evaluation of the gradient. In this section, we expose different consequences of this parameter.

##### 4.6.1. Analytical proof of formation's convergence

In [P2] we can find that “*Asymptotic convergence of the formation's rotational center to the location of the source was proven analytically for signal distributions that have circular level sets for two or more agents, and for those that have elliptical level sets for groups with an even number of agents.*”

In this study, the source, which is a sum of 3 ellipses, does not fulfil the condition of convexity. In the same way as in figures 8 and 9 of this paper, simulations confirms that  $d_c$  is not always decreasing but formation still always find the source location.

Moreover, some situations in simulation show that respectively 2 or 4 agents gives better performances than 3 or 5.

[Example A, conditions:  $n_{Tstransloop1}=2$ ,  $n_{TsAUV}=6$ ,  $n_{TslastAUV}=n_{TsASV}=13$ ,  $V_f=0.05\text{m/s}$ ,  $\alpha_1=\alpha_2=0$ , no filter on  $\Theta_f$ ]

Nb AUV	2	3	4	5
Mission duration	25362	26250	12709	17901
$T_m$ [s]				

##### 4.6.2. Cost of an agent

In a mission, an extra agent costs a lot of money.

For example, a single day mission causes the following costs:

Coast boat: 5000€/day (for crew + maintenance + depreciation)

First AUV: 5000 €/day (for crew + maintenance + depreciation)

Additional AUV: 1500€/day

In case of a more than one day mission, this is more expensive because of watch organization for the crew.

#### 4.6.3. 7.3. Number of agent and available bandwidth

In a TDMA protocol, an additional agent leads to increase cycle time.

In a OFDMA protocol, an extra agent leads to a decrease of the available bandwidth shared between all agents. This decrease of bandwidth increase the emission time and so can also lead in certain case to increase the cycle time.

This increasing of the cycle time can compromise the stability of the fleet and can oblige to set a slower speed of formation  $V_f$ .

The optimum number of agent is therefore linked to acoustic communication conditions and AUV technology (sample rate of AUV, modem performance, bitrate, ambient noise...).

[example B, conditions :  $nT_{stransloop1}=2$ ,  $nT_{sAUV}=6$ ,  $nT_{slastAUV}=nT_{sASV}=13$   $M1=M2=1$ , no filter on  $\Theta_f$ ]

Nb AUV	2	3	4	5
Cycle time loop 1 $T_c$ [s]	0.5	0.75	1	1.25
Cycle time loop 2 $T_c$ [s]	4	4.75	5.5	6.25
$V_f$ max m/s	0.05	0.2	0.1	0.05
Mission duration $T_m$ [s] $\alpha_1=\alpha_2=0$	25362	8256	6342.1	17901
Mission duration $T_m$ [s], $\alpha_1=\alpha_2=10\%$	34731	11466	9399	>30000

#### 4.7. Key results

We present here some results under certain conditions.

We represent a large number of possible situations in terms of packet loss because it reflects both different conditions of communication (configuration subject to multipath, ambient noise level, performance modems ...) and different choices in terms of operational data exchanged. For example, in the case of a larger volume to be exchanged for operational reasons (security, supervision ...), cycle times of communication will increase and the probability of packet loss as well.

In addition, through the repeater mechanism presented in section 5.4 that will compensate packet lost, we can also make the equivalence between packet loss and cycle times of communication.

##### 4.7.1. Quite favorable communication conditions

Cycle time are calculated with number of bits exchanged, modem bit rates and maximum distance between agents.

For example, cycle time used in example A, B and C corresponds to the following quite good conditions:

Parameter influencing cycle time of protocol :

Maximum distance between AUV = 200m

Maximum distance between ASV and AUV = 1500m

Bitrate between ASV and AUV = 100 bit/s



Bitrate between AUV = 480 bit/s  
 Number of bit exchanged between AUV and ASV = 60  
 Number of bit exchanged between AUV = 30

Parameter influencing cycle packet loss:

Emission level for network 1  $SL1=173$  db ref  $1\mu Pa$  at 1m

Acoustic noise for network1  $Nis1=90$  dbV/sqrt(Hz) at f

Emission level for network 2  $SL2=185$  db ref  $1\mu Pa$  at 1m

Acoustic noise for network2  $Nis2=75$ dbV/sqrt(Hz)

Maximum distance and number of bits exchanged are also influencing packet loss

[Example C, conditions:  $nTstransloop1=2$ ,  $nTsAUV=6$ ,  $nTslastAUV=nTsASV=13$   $M1=M2=1$ , filter on  $\Theta_f$ ,  $\alpha1=\alpha2=0\%$ ] – *Most favorable case for reference*

Nb AUV	2	3	4	5
Cycle time loop 1 Tc [s]	0.5	0.75	1	1.25
Cycle time loop 2 Tc [s]	4	4.75	5.5	6.25
Vf max m/s	0.15	0.15	0.15	0.15
Mission duration Tm [s], filter on $\Theta_f$ , $\alpha1=\alpha2=0\%$	4877.6	5587.1 (>4)*	4282.5	9993 (>4)*

[Example D conditions:  $nTstransloop1=2$ ,  $nTsAUV=6$ ,  $nTslastAUV=nTsASV=13$ , filter on  $\Theta_f$ ,  $\alpha1=\alpha2=10\%$ ]

Table for  $M1$ ,  $Vf=0.15$ m/s

Mission duration Tm [s],	$n0=2$ $M2^*=1$	$n0=3$ $M2^*=1$	$n0=4$ $M2=1$	$n0=5$ $M2^*=2$
$M1=1$	5020.1	6712.5	4958.3	4375
$M1=2$	12714	4883(>4)*	4252.4	4205.1
$M1=3$		5431.3	4286.4	8783
$M1=4$				

For  $n0=4$ ,  $M2^*=2$  but results are perturbed by a resonance (see annex 3). As  $M2=1$  and  $M2=2$  are very clothe in term of typical cycle time (see section 6.2), we present here results for  $M2=1$ .

Nb AUV	2	3	4	5
$M1$	1	2	2	2
$M2$	1	1	1	2
Cycle time loop 1 Tc [s]	0.5	1.5	2	2.5
Cycle time loop 2 Tc [s]	4	4.75	5.5	9.375
Vf max m/s	0.15	0.15	0.15	0.15
Mission duration Tm [s], filter on $\Theta_f$ , $\alpha1=\alpha2=10\%$	5020.1	4883(>4)*	4252.4	4205.1

#### 4.7.2. Quite difficult communication conditions

Parameter influencing cycle time of protocol:

Maximum distance between AUV = 300m  
 Maximum distance between ASV and AUV = 3000m  
 Bitrate between ASV and AUV = 100 bit/s  
 Bitrate between AUV = 480 bit/s  
 Number of bit exchanged between AUV and ASV = 200  
 Number of bit exchanged between AUV = 200

Parameter influencing cycle packet loss:

*Emission level for network 1*  $SL1=173$  db ref  $1\mu Pa$  at  $1m$

Acoustic noise for network1  $Nis1=90$  dbV/sqrt(Hz) at  $f$

*Emission level for network 2*  $SL2=185$  db ref  $1\mu Pa$  at  $1m$

Acoustic noise for network2  $Nis2=80$ dbV/sqrt(Hz)

Maximum distance and number of bits exchanged are also influencing packet loss

In network 1, for 200 to 300m of range,  $\alpha_1$  rapidly increases from 10% to 100%.  
 We consider here to represent a difficult case that  $\alpha_1=50\%$  for all communications.  
 Again, in network 2, for 2000 to 3000m of range,  $\alpha_2$  rapidly increase from 10% to 100%.  
 We consider here to represent a difficult case that  $\alpha_2=50\%$  for all communications.

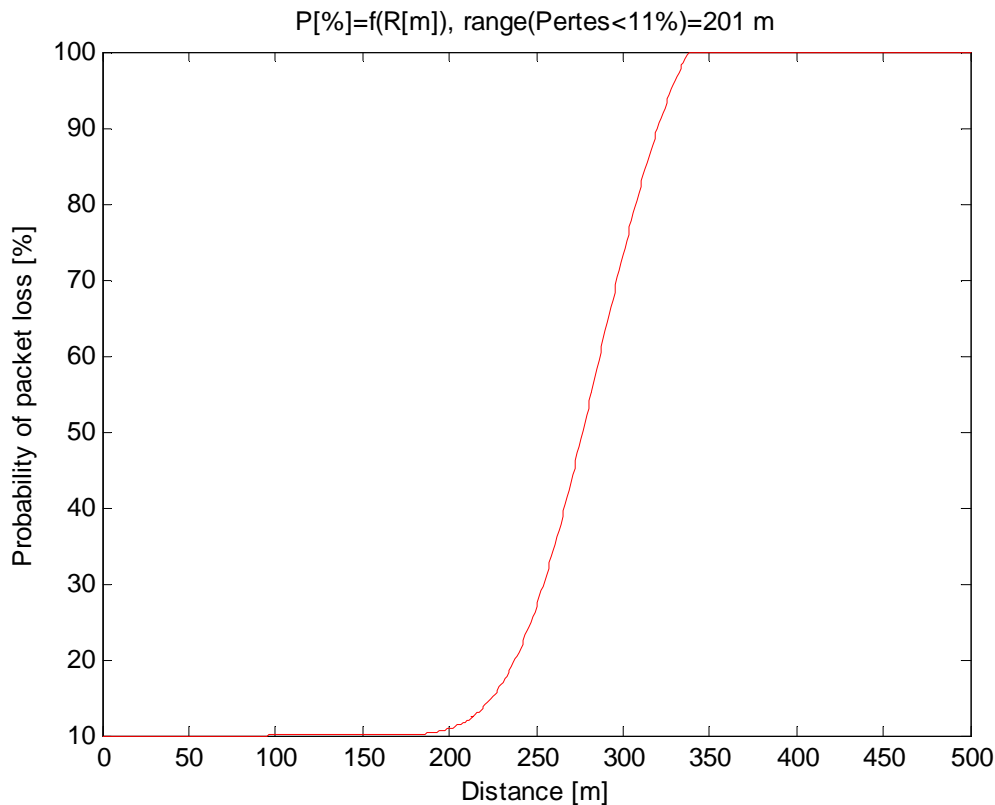

Network1 : Probability of packet loss for  $DI=2$ ,  $SL=173$  db ref  $1\mu Pa$  at  $1m$ ,  $Nis=90$  dbV/sqrt(Hz) at  $f$ ,  $BW=239.8833$ Hz,  $f=10$ kHz,  $\gamma_1=0.246$ ,  $Kb=200$  bits,  $k=2$

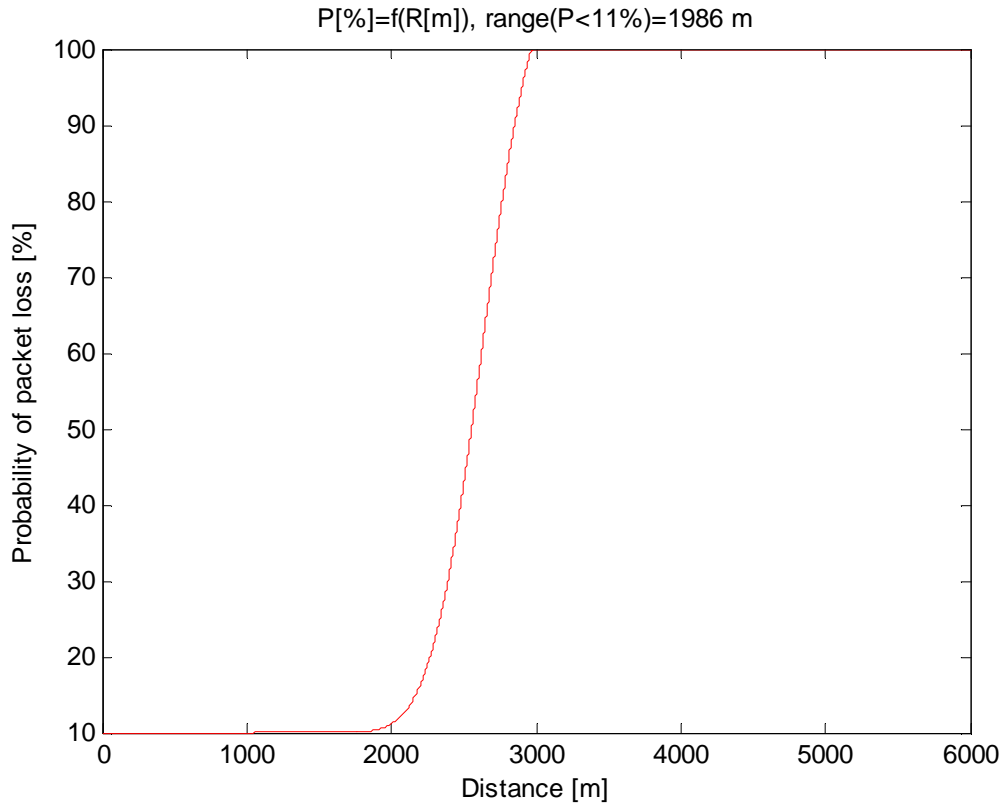

*Network2 : Probability of packet loss for  $DI=2$ ,  $SL=185$  db ref  $1\mu Pa$  at  $1m$ ,  $Nis=80$  dbV/sqrt(Hz) at  $f$ ,  $BW=239.8833Hz$ ,  $f=10kHz$ ,  $\gamma_1=0.246$ ,  $Kb=200$  bits,  $k=2$*

[Example E conditions:  $nTstransloop1=5$ , for  $M2=1$ ,  $nTsAUV=17$ ,  $nTslastAUV=nTsASV=33$ , filter on  $\Theta_f$ ,  $\alpha_1=\alpha_2=50\%$ ]

Table for  $M1$ ,  $V_f=0.15m/s$

Mission duration $T_m$ [s],	$n0=2$ $M2^*=3$	$n0=3$ $M2^*=3$	$n0=4$ $M2^*=4$	$n0=5$ $M2^*=4$
$M1=1$	10903		6783.3	6829.6
$M1=2$	5487.1	7565	4961.4	5234.1
$M1=3$	14739	6328.1	6524.1	5812.5
$M1=4$		10855		6320.3

For  $n=2$  to  $5$ :

Nb AUV	2	3	4	5
$M1$	2	3	2	2
$M2^*$	3	3	4	4
Cycle time loop 1 $T_c$ [s]	2.5	5.625	5	6.25
Cycle time loop 2 $T_c$ [s]	18.375	24.5	38.625	46.75
$V_f$ max m/s	0.15	0.15	0.15	0.15
Mission duration $T_m$ [s], filter on $\Theta_f$ , $\alpha_1=\alpha_2=50\%$	5487.1	6328.1	4961.4	5234.1

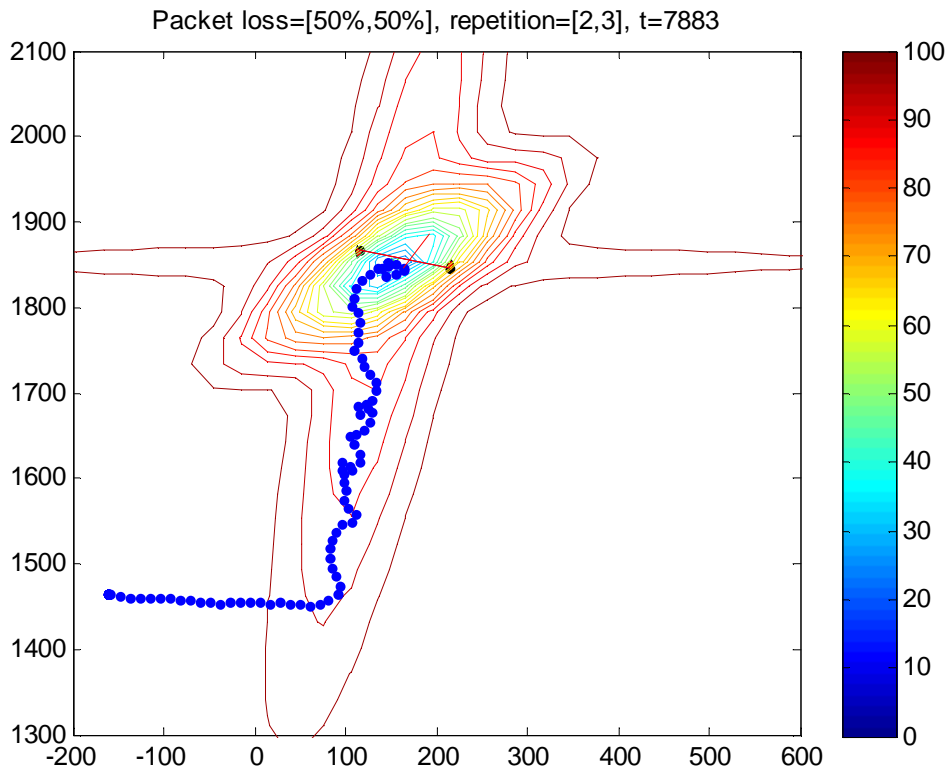

Trajectory of the fleet, 2 AUV,  $R=50\text{m}$ ,  
 $V_f=0.15\text{m/s}$ ,  $\alpha_1=\alpha_2=50\%$ ,  $M_1=2$ ,  $M_2=3$ ,  $T_t=7487\text{s}$ , filter on  $\Theta_f$

#### 4.7.3. Conclusion for the scenario

These results show that in this scenario, using more than 2 AUV does not increase the performance of the task significantly, both in good and bad conditions of communication. In addition, thank to the repetition technique and the robustness of the algorithms with respect to loss of communication, the task's performance is not significantly affected by bad communication condition.

#### 4.8. Other algorithms for practical implementation

Here is some proposition of other algorithms that would be useful to make the scenario implementable in real condition.

##### 4.8.1. Anti collision algorithm

Anti collision algorithm has not been included in loop2 because that kind of security algorithm has to be implemented independently at a lower level (like loop0).

A way to decrease the risk of collision is to set a relatively low but not null difference of depth for each AUV.

##### 4.8.2. Survey algorithm for first phase of the mission

The first phase of prospection into V-shape formation is not considered in these test.

An algorithm to manage the fleet from the launch of each AUV (probably one by one) to the V formation has also to be done.

Simulations we made of this phase were basically by defining the same speed and direction for each AUV (in an open loop way). When one of the agents detects a concentration bigger than a threshold, the algorithm switches to the circular formation mode.

#### 4.8.3. Depth management

Loop0 includes depth control but the depth has not been treated into loop1.

To perform the task of localization of a source, we consider the sub-task of finding the maximum of concentration in a plane.

Another algorithm has to be implemented to increase the depth when the maximum has been localized.

The way to detect that the minimum has been localized seems not to be trivial.

#### 4.8.4. Radius management

To improve performances, we can imagine an algorithm that would change the radius in some cases, for example:

- increase R when the computed gradient is too small
- decrease R when the gradient is high
- decrease R when the plume is too thin by detecting a loop shape trajectory.

#### 4.8.5. Speed of formation Vf management

To improve performances, an especially the robustness of the task, a management of Vf seems to be necessary.

Indeed, in case of large disturbance (current, communication ...), the circular formation can be broken. In this case, the calculated gradient and thus the direction of advance of the formation become false. It is then necessary to stop moving and wait for the formation is properly reformed and then permit to move again.

This algorithm would have to compute criteria that reflect the uniform distribution of agents around the circle and set Vf to 0 when the criteria is under a defined threshold.

#### 4.8.6. Displacement of the ASV

Even if ASV is not used in Loop2 for gradient search (centralized version), it should be used to perform the task of security and supervision of AUV.

In all cases, an algorithm has to be implemented to make it follow the fleet by tracking the [x,y] position of the center's formation.

#### 4.8.7. Gradient search for one single AUV

This could be interesting to develop and test a single AUV gradient search algorithm in order to compare with fleet performance and to use in some situation to perform the mission even when there is problem on all but one AUV.

#### 4.8.8. Use limited embedded energy consideration

To evaluate different scenario, we can uses energy consumption of AUV to evaluate different strategy.

#### 4.8.9. Use mean and variance for metric

In addition of mission time, we can use mean and variance of the position of the center from the mission time and during a fixed time.

#### 4.9. Annex 1 : parameters for simulation : `init_simulation.m`

```
%Fichier d'initialisation du simulateur MASim et MUSim
%config
tdma1=1;%use tdma protocol for formation loop (loop1)
gradsearch=1;
n0=3;%number of agents

% Sample time
global ST
global Ts
Ts=0.125;
ST=Ts;

%remise du zero à Nice
xn=4853722;
yn=-811176;
%source-----
-----
%équation source circulaire (modèle n°1)
r99s=500;
%source 3d-----
%paramètres
xs=154.3;%246.7;%154.3;%position x,y de la source
ys=1852.08;%30.89;
zs100=-250;%250 altitude de la source à 100%

m1=0.2;%pondération ellipse 1
m2=0.6;
m3=1;

Ps=1e-3;%mise à l'échelle

c1=1.9/10;%ellipse 1 : mi.exp(-Ps*(ai.x^2+bi.x.y+ci.y^2))
b1=0.01/10;%il faut a*c-b^2/4>0
a1=0.003/10;

c2=0.03/10;
b2=-0.2/10;
a2=1/20;

c3=0.9/10;
b3=-1/10;
a3=0.4/10;

alpha=0;
A=0;
Tm=120;

psource=[xs,ys,zs100,m1,m2,m3,Ps,c1,b1,a1,c2,b2,a2,c3,b3,a3,alpha,A,Tm];

%----calcul source basse définition pour l'affichage en ligne-----
sz=30;
X=linspace(-200,600,sz);
Y=linspace(1400,2200,sz);
[X,Y]=meshgrid(X,Y);
```

```
z=-200;
%calcul podération selon z
m=[m1*exp(0.1*(1-abs(z)/25)) m2*exp(0.1*(1-abs(z)/25)) m3]';% vecteur de
pondération pour chacune des 3 ellipses,

%remise à l'échelle de m : il y a 100% à xs,ys pour z=zs100
m=m*100/(m(1)+m(2)+m(3))*z/zs100;
M=((abs(z)+25)/50)*[a1 a2 a3;b1 b2 b3;c1 c2 c3];

%calcul de la salinité
Sal1=exp(-Ps*(M(1,1)*(X-xs).^2+M(2,1)*(X-xs).*(Y-ys)+M(3,1)*(Y-ys).^2));
Sal2=exp(-Ps*(M(1,2)*(X-xs).^2+M(2,2)*(X-xs).*(Y-ys)+M(3,2)*(Y-ys).^2));
Sal3=exp(-Ps*(M(1,3)*(X-xs).^2+M(2,3)*(X-xs).*(Y-ys)+M(3,3)*(Y-ys).^2));

Sal=m(1)*Sal1+m(2)*Sal2+m(3)*Sal3;

Sal=100-Sal; %pour avoir une salinité 0% en xs,ys
Salmap=Sal; %sert dans l'affiche en ligne de la simu
xmap=X;
ymap=Y;
%----calcul source affichage haute définition-----
sz=1000;
X=linspace(-3000,3000,sz);
[X,Y]=meshgrid(X,X);

z=-200;
%calcul podération selon z
m=[m1*exp(0.1*(1-abs(z)/25)) m2*exp(0.1*(1-abs(z)/25)) m3]';% vecteur de
pondération pour chacune des 3 ellipses,

%remise à l'échelle de m : il y a 100% à xs,ys pour z=zs100
m=m*100/(m(1)+m(2)+m(3))*z/zs100;
M=((abs(z)+25)/50)*[a1 a2 a3;b1 b2 b3;c1 c2 c3];

%calcul de la salinité
Sal1=exp(-Ps*(M(1,1)*(X-xs).^2+M(2,1)*(X-xs).*(Y-ys)+M(3,1)*(Y-ys).^2));
Sal2=exp(-Ps*(M(1,2)*(X-xs).^2+M(2,2)*(X-xs).*(Y-ys)+M(3,2)*(Y-ys).^2));
Sal3=exp(-Ps*(M(1,3)*(X-xs).^2+M(2,3)*(X-xs).*(Y-ys)+M(3,3)*(Y-ys).^2));

Sal=m(1)*Sal1+m(2)*Sal2+m(3)*Sal3;

Sal=100-Sal; %pour avoir une salinité 0% en xs,ys

%----fin source-----

%-----positions init auv-----
----
%global x0 y0 theta0
%team size
global n
n=5;
```

```

z0=[-200 -200 -200 -200 -200];%m - consigne de z pour les auv
z00=[-200 -200 -200 -200 -200];%positionnement à t=0
cap0=[-0.6 -0.3 0 0.3 0.6]+pi/2;%rad
theta0=cap0;

%feednetback
x0=5*[27 27 10 12 3]-200;%m%commande
y0=[1759          1759-32          1748          1780          1750]-
300;%m%commande
% x0=x0+700;
% y0=y0+500;

%position du centre (boule) à t=0
xc0=xs;
yc0=ys;

c0x=mean(x0(n-n0+1:n));
c0y=mean(y0(n-n0+1:n));

if n0~=n
    for i=1:n-n0
        x0(i)=-10000;
        y0(i)=-10000;
    end
end

%-----communication-----
-
%paramètres communication -à réviser selon besoins FNB
%loop 1:formation loop
Vsound=1500;%m/s
load pdprd.mat %for repetability of packet dropout

if tdma1==1
    %loop 1:formation loop
    %data exchanged: psi
    nbit1=30;%30 or 200
    header1=0;

    %netwrok1 :AUV-AUV
    D1=480;%bits/s
    l1=200;%300 or 200 maximum distance (between auv)
    DeltaDmax1=l1;%maximum difference of distance between 2 sources and
receptor : AUV can be very close to each other
    Tel=(header1+nbit1)/D1;%emission time
    Tt1=l1/Vsound;%total travel time
    Ts1=DeltaDmax1/Vsound;%security travel tim
    T1=n*(Tel+Tt1);%tdma base time
    nTsTransmission=floor((Tel+Tt1)/Ts)+1;%if =0 then all to all
communication simultaneous
    nTsDelay=0;%delay include into tdma protocol

else

    nTsTransmission=0;%if =0 then all to all communication
    nTsDelay=0;

end

```



```

Tdelay=Ts*nTsDelay;

M1=3;
alpha1=0.1^M1;
nTsTransmission=nTsTransmission*M1;
pdprd10=pdprd1(1:floor(40000/(nTsTransmission*n0*Ts)*5*n0));%from
pdpprd.mat using always the same random vector

%%loop 2:grad search-----
nbit20=60;%200 or 60      emission angle and salinity
nbit21=60;%200 or 60      emission cx,cy,cpx,cpy,cppx,cppy
header2=0;

D2=100;%bits/s
DeltaDmax2=88.31;%maximum difference of distance between 2 sources and
receiver : AUV can be very close to each other
%88.31 is for zmin=500m and ddlmax=100m
l2=1500;%1500maximum or 3000m distance
Te20=(header2+nbit20)/D2;%emission time ASV
Te21=(header2+nbit21)/D2;%emission time AUV
Tt2=l2/Vsound;%travel time
Ts2=DeltaDmax2/Vsound;%security travel tim

M2=1;%repetition
alpha2=0.1^M2;

Ttauv=M2*Te20+Ts2;%4 first auv
Ttlastauv=M2*Te20+Tt2;%last auv
Ttasv=Te21+Tt2;%asv feedback
nTsTtauv=floor(Ttauv/Ts)+1;
nTsTtlastauv=floor(Ttlastauv/Ts)+1;
nTsTtasv=floor(Ttasv/Ts)+1;
Tmod2=(nTsTtauv*(n0-1)+nTsTtlastauv+nTsTtasv)*Ts;
Tasv=(nTsTtauv*(n0-1)+nTsTtlastauv)*Ts;

nTsDelay2=0;%dely included into tdma protocol
Tdelay2=Ts*nTsDelay2;

pdprd20=pdprd2(1:floor(30000/Tmod2*5));%from pdpprd.mat using always the
same random vector

%modèle dynamique AUV-----
-
load data_dyn.mat

Tsp=Ts;
Tst=Ts;
Tsu=Ts;
Tsz=Ts;

%-----paramètres algo formation-----
-----
%team position
KT0=zeros(10,n);

for i=1:n
    KT0(2,i)=x0(i);

```

```
    KT0(3,i)=y0(i);
end
KT02=[KT0,zeros(10,1)];

%reglage1=modele cinematique, simus rapides, Vauv=50m/s
%reglage2=modele cinematique, Vauv=1m/s
%reglage3=modele dynamique, Vauv=1m/s

R=50;%50 10%reglage 1=50;reglage2 et 3 =50
v0max=1;
global w0
w0=v0max/R;%reglage 1=1;reglage2 et 3 =v0max/R

%velocidad de los agentes
global v0
v0=w0;%reglage2 =w0

%modem range network 1
global rho
rho=11;
% rho=170;%300 %reglage 1=50;reglage2 =1000
% if n0<3
%   rho=190 ;
% end
%constantes de los controladores
global kappa
kappa=100;%100%200;%reglage 1 =w0;%formationreglage2 =50 reglage 3 = 100
global beta
beta=0.01;%0.01 reglage 1 =.2*kappa;%distribution reglage2 et 3=0.01

%-----paramètres algo source seeking-----
% SPEED LIMIT FOR SOURCE SEEKING
speed_limit=0.15;%0.4;%5;%5%1.5;%0.2%6

%-----affichage situation initale-----
-
close all
contour(X,Y,Sal,20), colorbar
caxis([0,100])
hold
plot(x0,y0, '*')
```

#### 4.10. Annex 2 : Acoustic communication calculation

From [D8.01], we get the following equation and parameters:

« 6.2.3. [...]

*Acoustic modem Transmit Input values:*

Source Level SL = from 173 dB up to 185 dB ref 1μPa at 1m by step 3

Baud rate = 100 bps up to 500bps by step 100

Transmitter = omni directional

*Acoustic modem Receive parameters:*

Probability of Detection (PD)  $\approx 1 - \text{erf}(\sqrt{MSNR}/2) = 10^{-2} / 10^{-3} / 10^{-4}$

With respectively "MSNR" = 9 dB/ 12,5dB/ 16dB "Minimum Signal to Noise Ratio" to obtain the wished maximum bit error rate

Receiver = omni directional

*Acoustic Channel parameters: Transmission Loss*

$TL = 20 \cdot \log(R) + a_0 \cdot R/1000$

With Relative Slant Range in meters (100m up to 2000m by step 100m)

$a_0$  in dB/km can be computing with the François Garrison formula (Annex I) or deducted from Tables (Annex I)

Environment:

Nis = Ambient Noise Level in dBV/√Hz for the receiver nominal frequency .

Nis = 70- 16.6\*Log(f nominal) + x dB and x = 0 to 30 dB step 5

The geometrical configuration:

The relative horizontal range between the vehicles are supposed to be greater than five time

the relative altitude.

The results are obtained from the sonar equation and correspond to maximum range in function of Nis.

$SL - TL - Nis - 10 \cdot \log(BW) + DI + GT \geq MSNR$

With Receive Level RL = SL - TL

Noise Level NL = Nis + 10 log(BW)

S/B computed = RL - NL + DI

For DI an example is given Annex I

[...]

6.2.4 [...]

Additional effects like local turbulence, local shading, multipath etc. is represented by a 10% constant packet failure rate.

»

From these equations, to calculate the probability of packet loss, we use the following method:

SNRdb received = SL-TL-Nis-10log(BW)+DI

We define Gamma1 the detection algorithm performance implemented into the modem:

Probability of bad detection  $P_s = \text{erfc}(\sqrt{\text{gamma1} \cdot 10^{(SNRdb/10)}})/2$ ;

Probability of packet loss for a packet of Kb bits:

$P_p = \min(1 - (1 - P_s)^{K_b}, 1)$

#### 4.11. Annex 3: Other table of results

[Example C', conditions:  $nT_{stransloop1}=2$ ,  $nT_{sAUV}=6$ ,  $nT_{slastAUV}=nT_{sASV}=13$   $M1=M2=1$ , filter on  $\Theta_f$ ,  $\alpha_1=\alpha_2=0\%$ ] – Most favorable case for reference

Nb AUV	2	3	4	5
Cycle time loop 1 Tc [s]	0.5	0.75	1	1.25
Cycle time loop 2 Tc [s]	4	4.75	5.5	6.25
Vf max m/s	0.2	0.2	0.15	0.1
Mission duration Tm [s], filter on $\Theta_f$ , $\alpha_1=\alpha_2=0\%$	3470.1 (>12)*	4562.8 (>7)*	4282.5	6264.8

[Example D conditions:  $nT_{stransloop1}=2$ ,  $nT_{sAUV}=6$ ,  $nT_{slastAUV}=nT_{sASV}=13$ , filter on  $\Theta_f$ ,  $\alpha_1=\alpha_2=10\%$ ]

For  $n=4$ , table for  $M1$  and  $M2$ ,  $V_f=0.15\text{m/s}$

Mission duration Tm [s],	$M2=1$	$M2^*=2$	$M2=3$
$M1=1$	4958.3	14282	4715.6
$M1=2$	4252.4	15698	4319.9
$M1=3$	4286.4	11379(>7)*	

For  $n=5$ , table for  $M1$  and  $M2$ ,  $V_f=0.15\text{m/s}$

Mission duration Tm [s],	$M2=1$	$M2^*=2$	$M2=3$
$M1=1$	11755(>4)*	4375	
$M1=2$	7032.6	4205.1	4205.3
$M1=3$		8783	

[Example D' conditions:  $nT_{stransloop1}=2$ ,  $nT_{sAUV}=6$ ,  $nT_{slastAUV}=nT_{sASV}=13$   $M1=M2=1$ , filter on  $\Theta_f$ ,  $\alpha_1=\alpha_2=10\%$ ]

Nb AUV	2	3	4	5
Cycle time loop 1 Tc [s]	0.5	0.75	1	1.25
Cycle time loop 2 Tc [s]	4	4.75	5.5	6.25
Vf max m/s	0.15	0.2	0.2	0.1
Mission duration Tm [s], filter on $\Theta_f$ , $\alpha_1=\alpha_2=10\%$	5020.1	5001.9	3401	8101

[Example E conditions:  $nT_{stransloop1}=5$ , for  $M2=1$ ,  $nT_{sAUV}=17$ ,  $nT_{slastAUV}=nT_{sASV}=33$ , filter on  $\Theta_f$ ,  $\alpha_1=\alpha_2=50\%$ ]

For  $n=2$  table for  $M1$  and  $M2$ ,  $V_f=0.15\text{m/s}$

Mission duration $T_m$ [s],	$M2=1$	$M2=2$	$M2^*=3$	$M2=4$	$M2=5$
$M1=1$	7729	10206	10903		
$M1=2$	7723	11574	5487.1	6111.5	10736
$M1=3$	6437.5	18889	14739		
$M1=4$	9529	26191			

For  $n=3$ , table for  $M1$  and  $M2$ ,  $V_f=0.15\text{m/s}$

Mission duration $T_m$ [s],	$M2=1$	$M2=2$	$M2^*=3$	$M2=4$	$M2=5$	$M2=6$
$M1=1$						
$M1=2$		7800.4	7565	7175.6	13536	
$M1=3$		7260.1	6328.1	6361.8	5311.9	20771
$M1=4$			10855	8471	9029	

For  $n=4$ , table for  $M1$  and  $M2$ ,  $V_f=0.15\text{m/s}$

Mission duration $T_m$ [s],	$M2=1$	$M2=2$	$M2=3$	$M2^*=4$	$M2=5$
$M1=1$				6783.3	
$M1=2$		6409.4	9617*( $>6$ )	4961.4	4996.3
$M1=3$	11320	6315.5	7550.3	6524.1	
$M1=4$		7741.9			

For  $n=5$ , table for  $M1$  and  $M2$ ,  $V_f=0.15\text{m/s}$

Mission duration $T_m$ [s],	$M2=1$	$M2=2$	$M2=3$	$M2^*=4$	$M2=5$
$M1=1$			9314	6829.6	
$M1=2$		7842.6	4629.8	5234.1	8536
$M1=3$	13617	5148.5	4847.3	5812.5	
$M1=4$	13725	4716	8193	6320.3	
$M1=5$		5841.9			

[Example E' conditions:  $nT_{stransloop1}=5$ , for  $M2=1$ ,  $nT_{sAUV}=17$ ,  $nT_{slastAUV}=nT_{sASV}=33$ , filter on  $\Theta_f$ ,  $\alpha_1=\alpha_2=50\%$ ]

For  $n=3$ , table for  $M1$  and  $M2$ ,  $V_f=0.2\text{m/s}$

Mission duration $T_m$ [s],	$M2=1$	$M2=2$	$M2=3$	$M2=4$	$M2=5$
$M1=1$					
$M1=2$		11955	10044		
$M1=3$		5440.6	4721.4	5441.8	
$M1=4$		9923	12284		

#### 4.12. Bibliography

[R1] : Sebastien Varrier, Daniel Simon, Olivier Sename, Emilie Roche and John-Jairo Martinez-Molina, "Robust control of autonomous underwater vehicles" , public report of ANR project Connect <http://www.gipsa-lab.inpg.fr/projet/connect/reports.php>

[P1] : Lara Briñon-Arranz, Alexandre Seuret, and Carlos Canudas-de-Wit, "Elastic formation control based on affine transformations" , American Control Conference 2011, SanFrancisco, USA

[P2] : Brandon Moore, Carlos Canudas-de-Wit, "Source Seeking via Collaborative Measurements by a Circular Formation of Agents" IEEE American Control Conference, Jun 2010, Baltimore, Maryland, United States. pp. s/n

[P3]: Alireza Farhadi, Jonathan Dumon, Carlos Canudas-de-Wit "Data Fusion And Tracking Of An Underwater Source Flow By A Fleet Of AUVs". Submitted to ACC2012

[D8.01] : Jan Opderbecke , "Description of the scientific mission scenario(s) to be investigated for the marine application", Feednetback public report

[D8.02] : Jan Opderbecke, Alain Kibangou , " Tools for Underwater Fleet Communication", Feednetback public report

[D8.03] : Jan Opderbecke, Michel Perrier, Jonathan Dumon, "Description of the multi vehicle simulator", Feednetback internal report

## 5. Section III

### Results of single network simulations

In this section we present simulation results obtained with the single network architecture.

#### 5.1. Overview

The communication between underwater vehicles and that between vehicles and surface system use the same acoustic channel, and since all transmissions must be sequentially organized in a time division media access (TDMA) scheme, the communication cycle duration is significantly longer compared to the double network architecture used in section II. The mission duration  $T_m$  is calculated as explained in section 4.3.4

The set of simulations has been realized with the aim to establish insight on the impact and choice of the main simulation parameters, which are:

- the number of underwater vehicles;
- the radius of the fleet formation circle;
- the acoustic reliability of communication in shape of the rate of packet loss;
- the scale of the plume which center (source) is to be localized.

In this second section of AUV fleet simulations, the underlying communications network concept is that of a single SIMPLEX channel used for both vehicle-to-vehicle communication and vehicle-to-surface communication.

The overall cycle duration is of course longer than in section2, and it increases with growing depth of the fleet.

#### 5.2. Catalogue of *simulated configurations and results*

The following paragraphs summarize the sets of simulations which aim is to show the influence of different system parameters.

### 5.2.1. Data loss and repetitions

Effect of repetitions in a bad acoustic environment.

Configuration:

- AUV's messages: 30 bit
- ASV's messages: 60 bit
- bitrate: 480 byte/s
- max. distance: 1500 m
- radius of the fleet : 50 m
- speed of formation: 0.15 m/s
- vehicle speed: 1 m/s

Results:

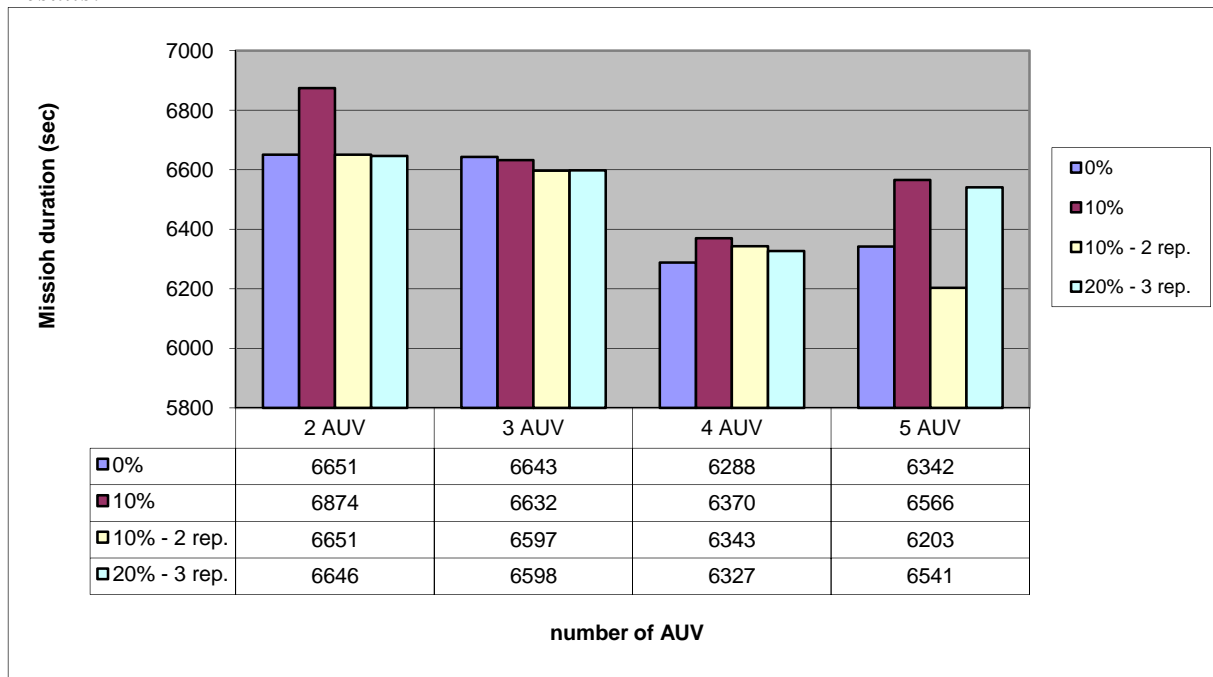

Behaviour: (For 4 AUVs with 10% of loss.)

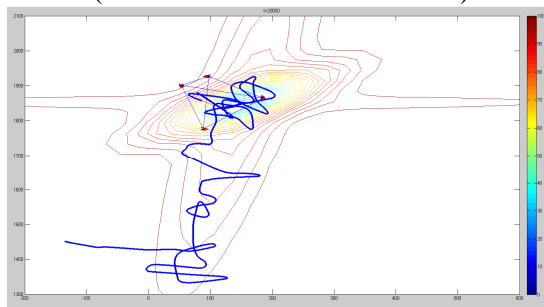

1 repetition

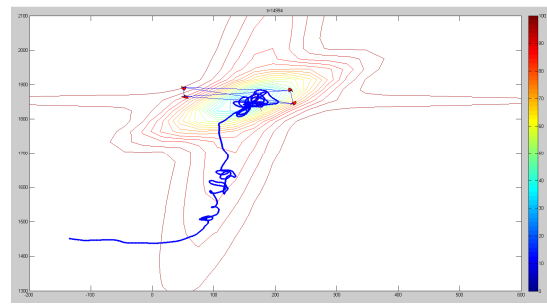

2 repetitions



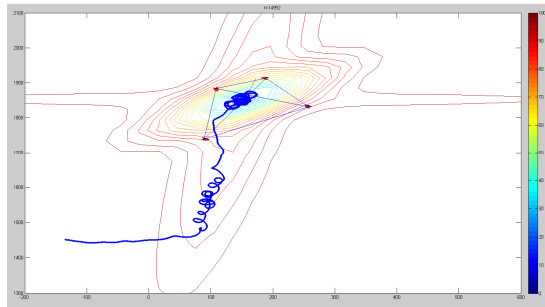

3 repetitions

Note for comparison with section II :  $n$  repetitions corresponds to parameter  $M1=n$

*Conclusion:*

At least one repetition of each acoustic packet significantly increases the convergence of the consensus algorithm, and by doing this improves the performance of formation holding and gradient climbing of the fleet. This means that the increase in the communication cycle duration due to message repetition has fewer drawbacks than it is beneficial to the information exchange and gradient search.

The best performance is achieved with a fleet of four AUVs.

### 5.2.2. Radius and number of agents

#### Configuration:

- AUV's messages: 200 bit
- ASV's messages: 200 bit
- bitrate: 480 byte/s
- max. distance: 3000 m
- radius of the fleet : 50 m
- speed of formation: 0.1 m/s
- data loss: 0%
- vehicle speed: 1 m/s

#### Results:

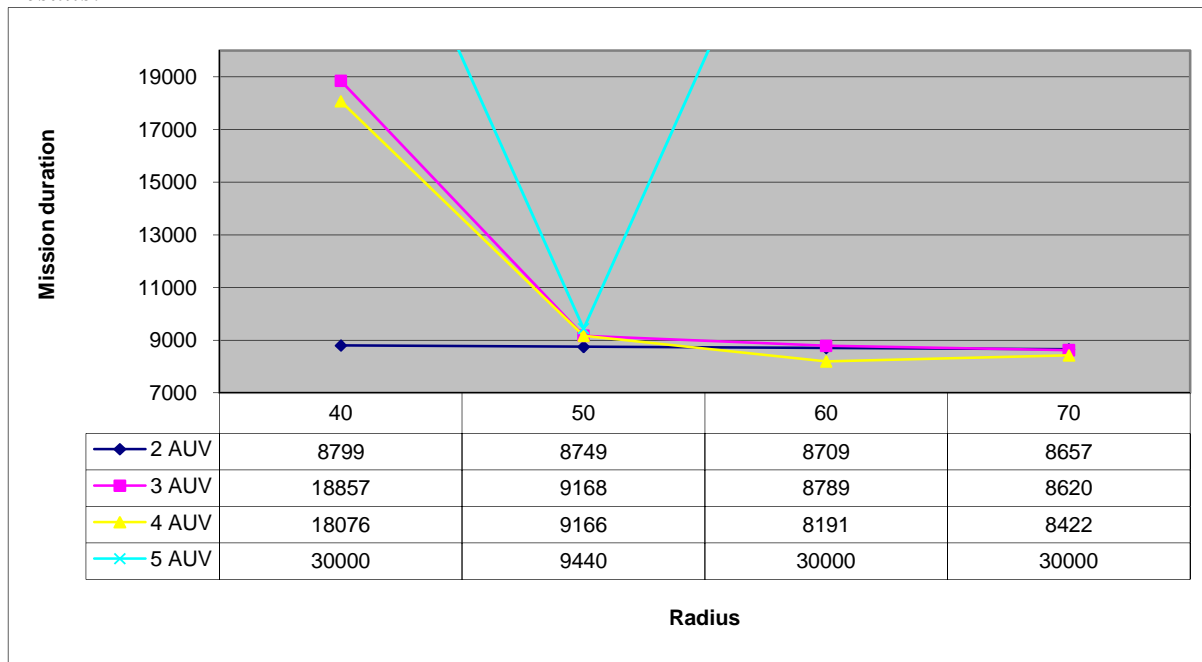

#### Behaviour: (case 2 AUV)

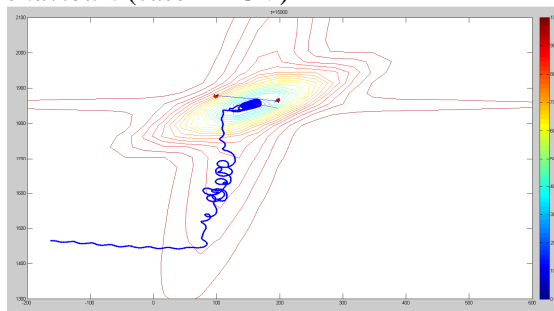

R = 40m

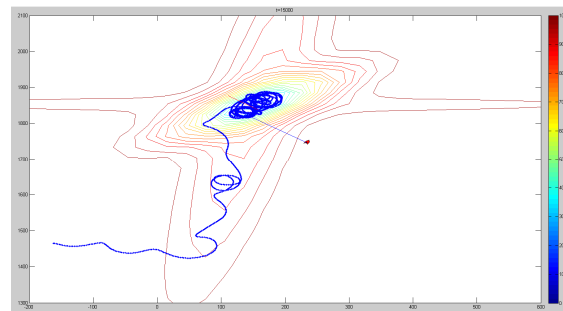

R = 60m

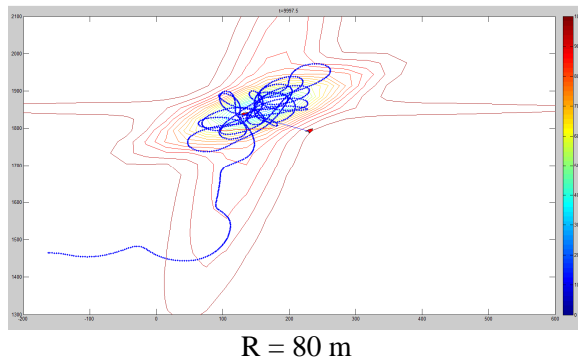

*Conclusion:*

Only a two-vehicle fleet can hold a circle formation with radius below 50m. We can explain this by the dynamic constraints to fulfill described in section 4.5.3: there is a strong dependency between vehicle velocity  $V_0$ , fleet velocity  $V_f$  and circle radius  $R$ .

Larger values of the circle radius give good convergence in the first part of gradient climb, when approaching the source, meaning a distance from the source in the same order than the radius; smaller circles provide more precise convergence.

Adaptive adjustment of the radius is a promising perspective to optimize convergence in all phases of the search.

### 5.2.1. Radius and data loss

*Configuration:*

- AUV's messages: 200 bit
- ASV's messages: 200 bit
- bitrate: 480 byte/s
- max. distance: 3000 m
- radius of the fleet : 50 m
- speed of formation: 0.1 m/s
- number of agents: 2
- vehicle speed: 1 m/s

*Results:*

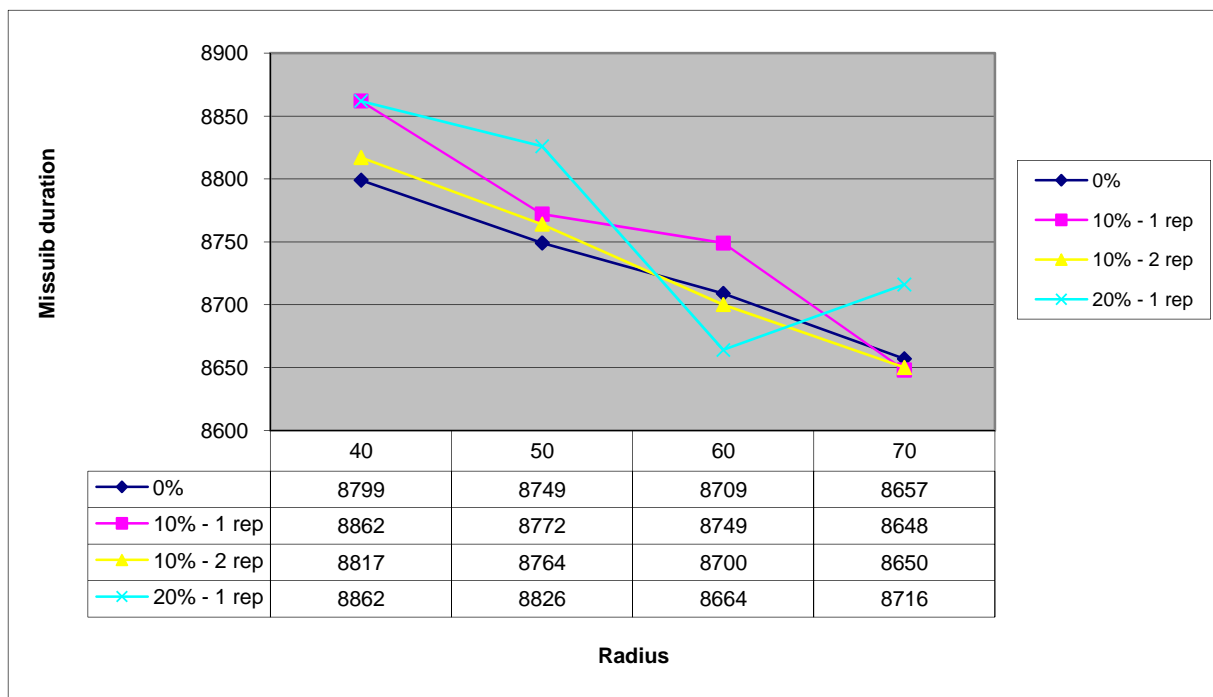

*Conclusion:*

Simple or double packet repetition allows maintaining similar performance up to 20% packet loss.

### 5.2.2. Speed of formation

Configuration:

- AUV's messages: 200 bit
- ASV's messages: 200 bit
- bitrate: 480 byte/s
- max. distance: 3000 m
- radius of the fleet : 50 m
- data loss: 0%
- vehicle speed: 1 m/s

Results:

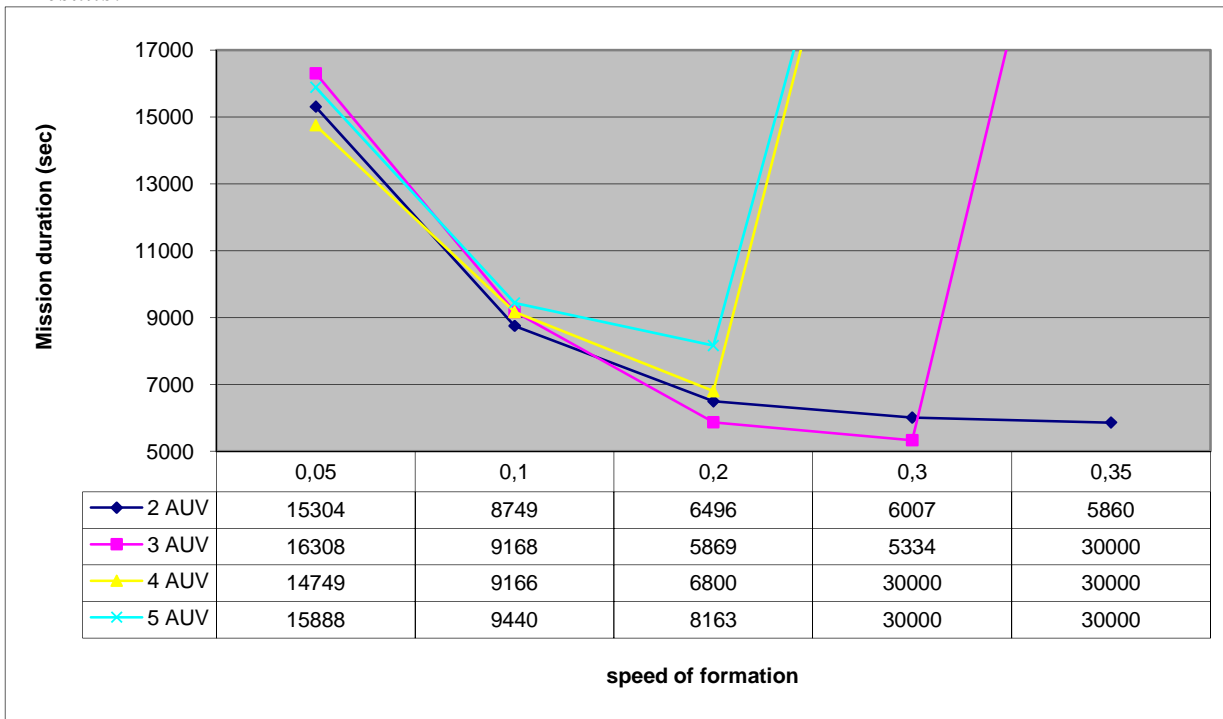

Behaviour: (case with 2 AUV)

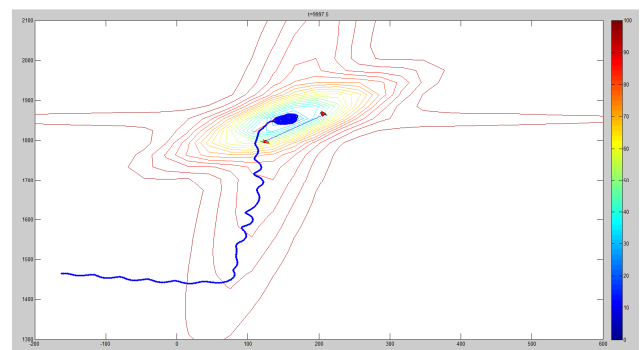
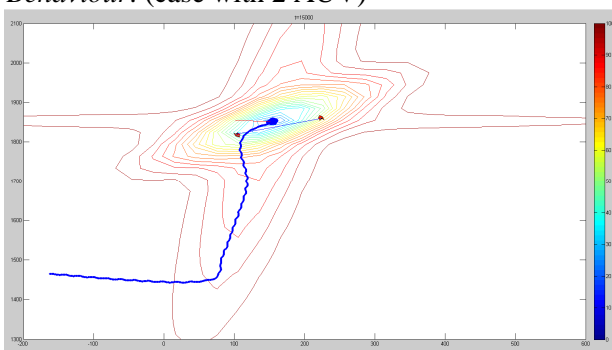

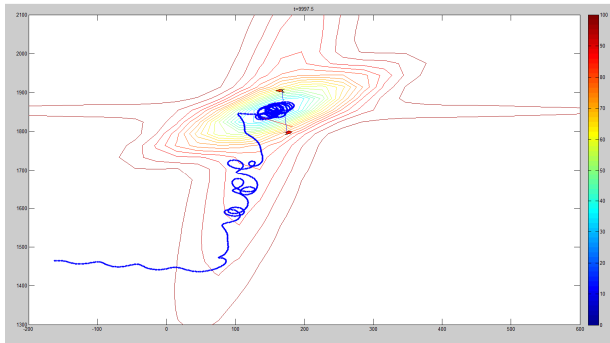
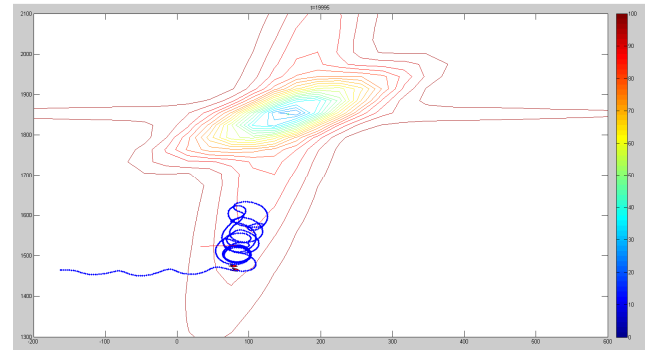
 $V_f = 0.3 \text{ m/s}$  $V_f = 0.4 \text{ m/s}$ 

*Conclusion:*

Increasing the velocity of the formation centre relative to the single vehicle velocity is leading to a degraded formation control; up to a certain degree (here 0.2m/s) the degradation is outweighed by a faster approach of the source. The larger the fleet, the larger the risk that the formation collapses, it is then unable to reach the source. The smaller the fleet, especially with two AUVs, the better the formation resists to a higher formation velocity.

### 5.2.3. Number of agents

Configuration:

- AUV's messages: 200 bit
- ASV's messages: 200 bit
- bitrate: 480 byte/s
- max. distance: 3000 m
- radius of the fleet : 50 m
- vehicle speed: 1 m/s
- data loss: 0%

Results:

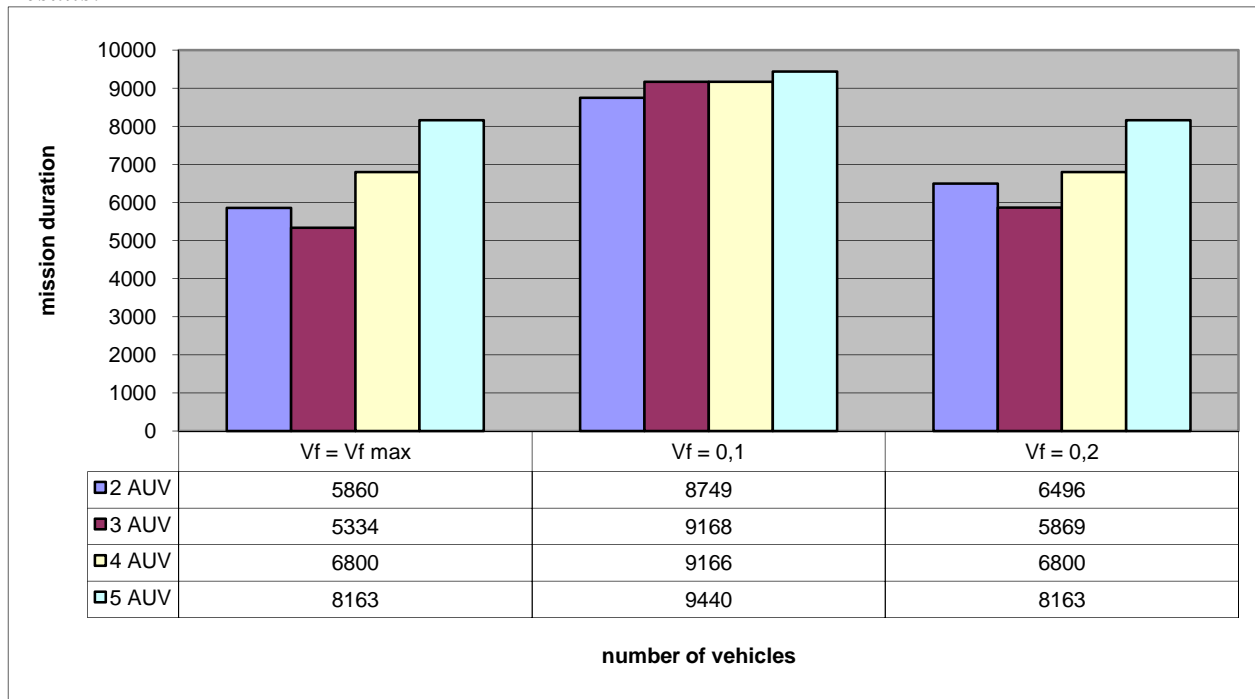

Behaviour: (case Vf = 0.1 m/s)

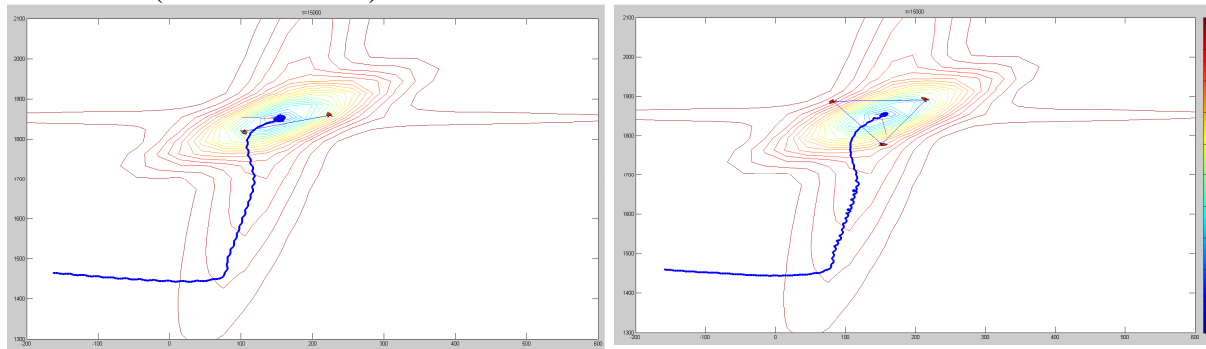

2 AUV

3 AUV

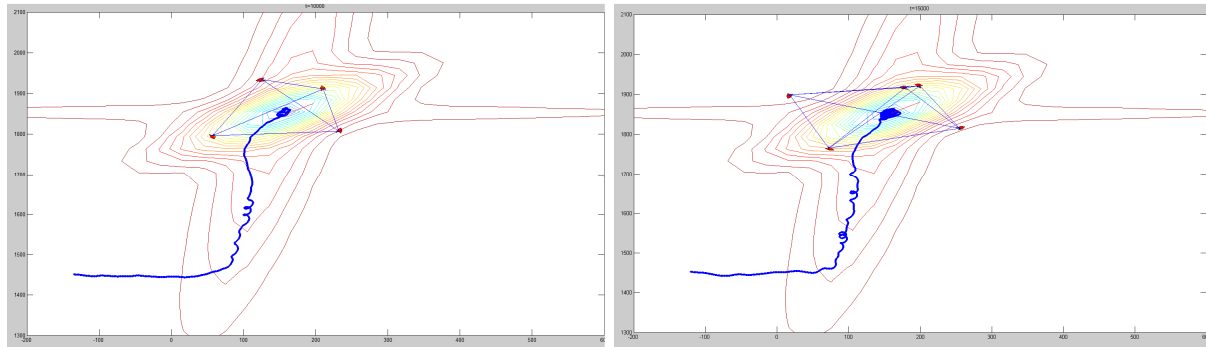

4 AUV

5 AUV

*Conclusion:*

This set of simulation shows that the increase in the number of AUVs does not necessarily improve performance. This is explained by the 'cost' in terms of time necessary for communication and for maintaining the formation.



### 5.2.4. Speed of vehicles

#### Configuration:

- AUV's messages: 200 bit
- ASV's messages: 200 bit
- bitrate: 480 byte/s
- max. distance: 3000 m
- radius of the fleet : 50 m
- data loss: 0%
- speed of formation: 0.1 m/s

#### Results:

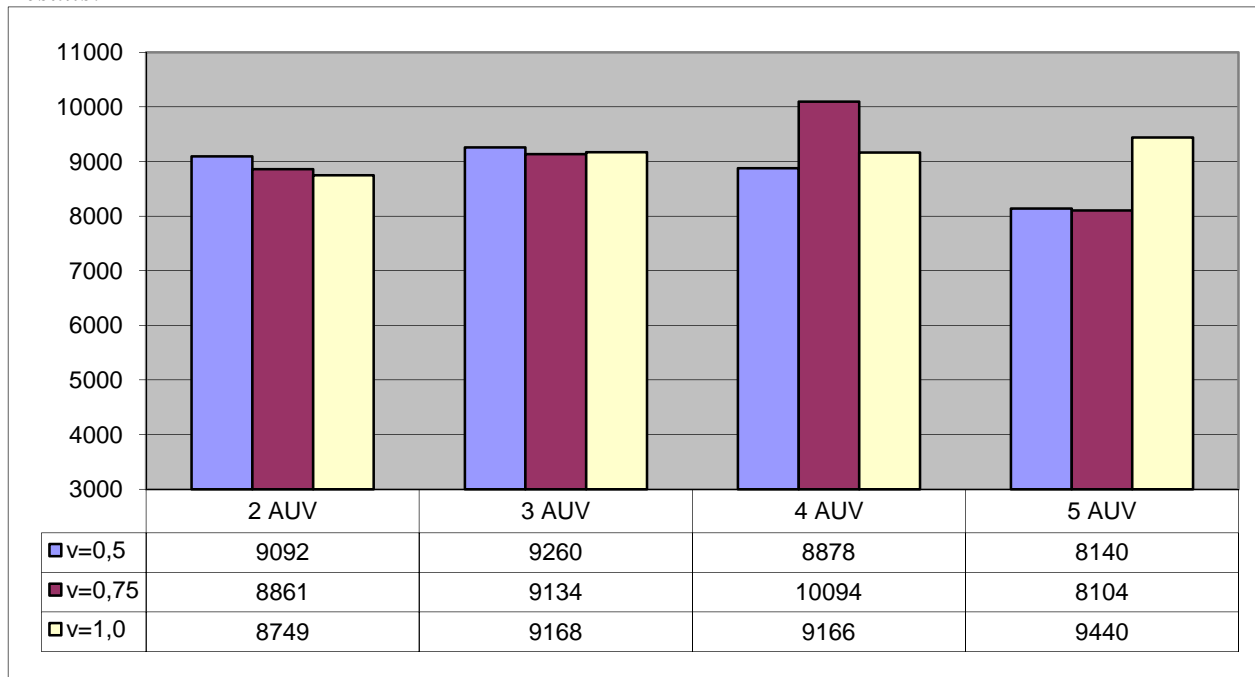

#### Behaviour: (case 2 AUV)

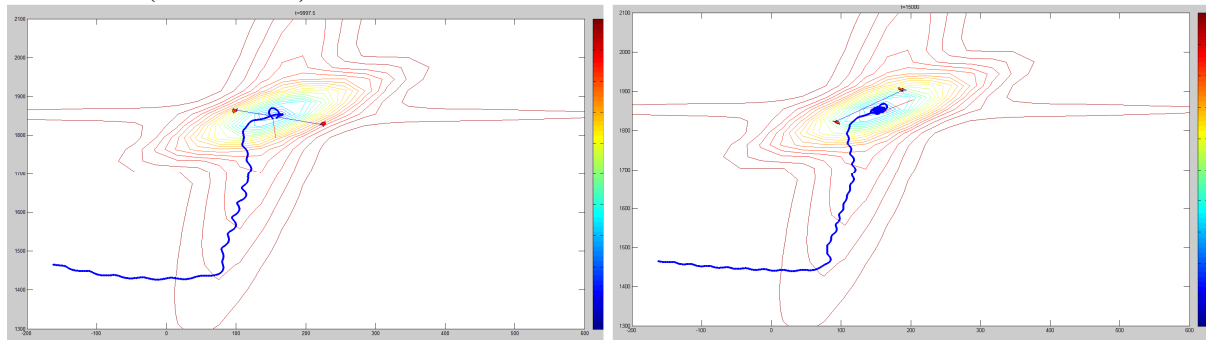

v = 0.5 m/s

v = 0.75 m/s

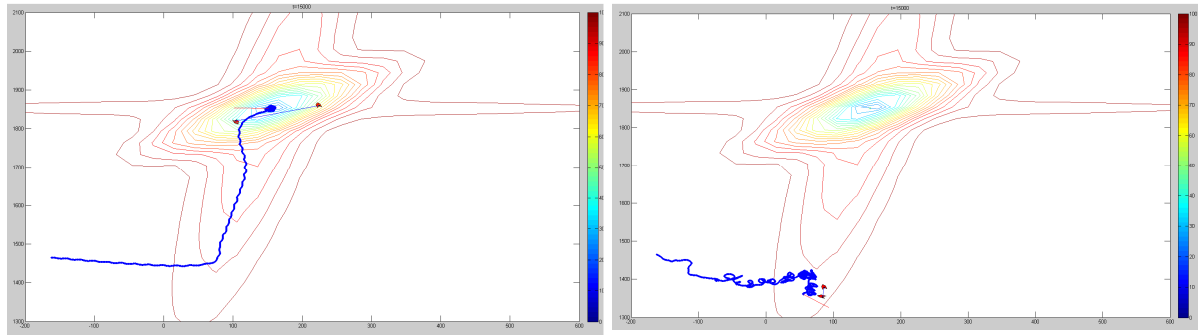
 $v = 1.0 \text{ m/s}$  $v = 1.25 \text{ m/s}$ 

*Conclusion:*

The apparent impact of the vehicle velocity is explained by effects of the hydrodynamic model on which is based the simulation. A higher vehicle velocity should lead to a shorter cruise towards the target.

### 5.2.5. Radius with a source 10 times larger

#### Configuration

- AUV's messages: 200 bit
- ASV's messages: 200 bit
- bitrate: 480 byte/s
- max. distance: 1500 m
- vehicle speed: 1 m/s
- data loss: 10%
- repetitions: 2
- speed of formation: 0.3 m/s

#### Results:

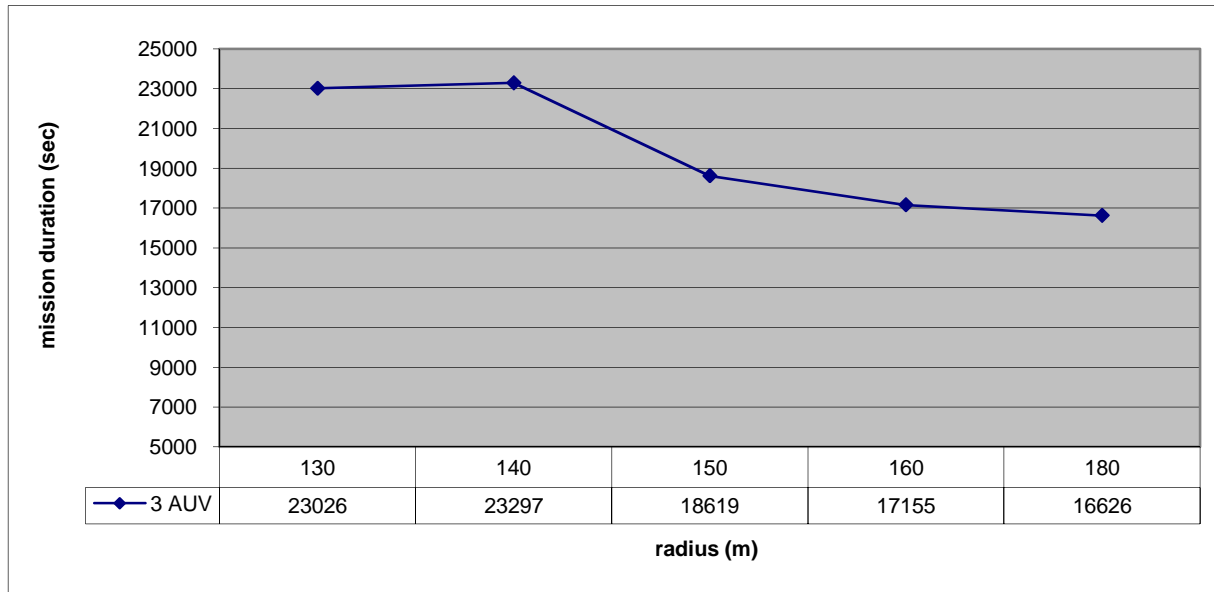

#### Behaviour:

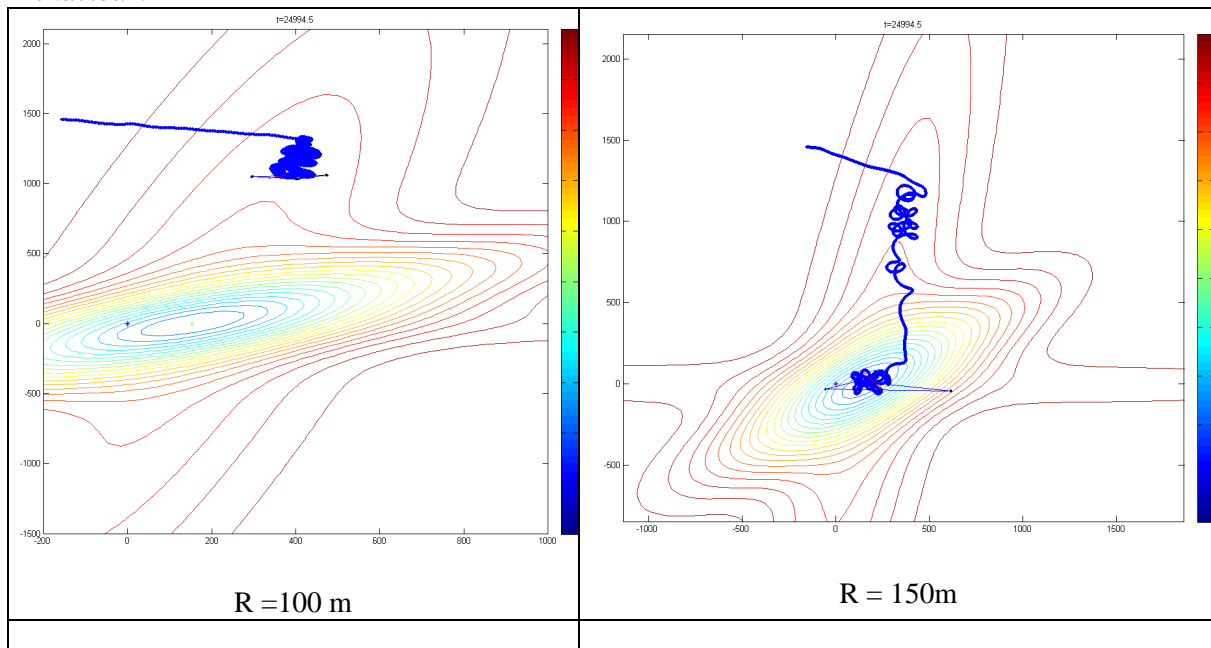

*Conclusion:*

The capability of the fleet to converge towards the source is impacted by the size/scale of the plume. This result shows that one has to be careful when interpreting the various simulations in this document – it is easy to understand that the spatial extent of an AUV fleet must be adapted to the nature and shape of the diffusion problem.

### 5.3. Conclusions

The geometric extension of the fleet formation proves to be sensitive to the shape and amplitude of the diffusion plume. The reason for this is the robustness of the gradient estimation. Since it is easy to see that the model for the diffusion plume used in the presented simulation is an arbitrary choice, the impact of the formation size is difficult to analyze.

We emphasize in the analysis on the capability of the fleet to hold the formation, to follow the consensus elaborated trajectory, and to perform a globally successful gradient search.

In this context, the principle observations are:

1. the maintaining of the formation is realistically achieved with the network concept of this section, even if the exchange of information is longer;
2. the loss of data within the acoustic transmission is to a significant extent compensated by a systematic repeat strategy (1 or 2 repeat cycles);
3. the fleet velocity cannot easily be increased without disturbing the formation process;
4. increasing the vehicle velocity permits increasing the fleet velocity to some extent;
5. the performance of the gradient climb algorithm is largely depending on a complete set of parameters – not all of the configurations lead to a stable trajectory towards the target, some configurations prove to be unstable; the complexity of the system induces a chaotic behavior of the results based on some parameters which explains the variability of results;
6. the number of vehicles has a low impact on the performance; the network cycle duration is increasing with a growing number of vehicles, and maintaining the formation is taking more effort; the quality of gradient estimation does not seem to gain significantly from a number of four vehicles onward; an advantage in increasing the number of agents can be seen in higher robustness to single AUV failure.

The gradient climb is depending on two main points: 1) the geometric quality of the gradient estimation which is linked to the shape of the plume and the spatial extent of the fleet, 2). Adaptive handling of the size/radius of the fleet could be an answer to this problem;

Working at a larger scale of the concentration field translates by a less efficient gradient climb; this is explained by the small amplitude change of the gradient between different vehicles, and the higher sensitivity of the gradient estimation with respect to the fleet geometry.

The global conclusions obtained from the two sets of simulations according to sections 1 and 2 are compared and commented in the corresponding paragraph of section 1.