



HAL
open science

Objective and subjective characterization of saxophone reeds

Bruno Gazengel, Jean François Petiot

► **To cite this version:**

Bruno Gazengel, Jean François Petiot. Objective and subjective characterization of saxophone reeds. 2013. hal-00782949v2

HAL Id: hal-00782949

<https://hal.science/hal-00782949v2>

Preprint submitted on 31 Jan 2013

HAL is a multi-disciplinary open access archive for the deposit and dissemination of scientific research documents, whether they are published or not. The documents may come from teaching and research institutions in France or abroad, or from public or private research centers.

L'archive ouverte pluridisciplinaire **HAL**, est destinée au dépôt et à la diffusion de documents scientifiques de niveau recherche, publiés ou non, émanant des établissements d'enseignement et de recherche français ou étrangers, des laboratoires publics ou privés.

Objective and subjective characterization of saxophone reeds

Bruno Gazengel*, Jean-Francois Petiot**

(*)LUNAM Université, Université du Maine, UMR CNRS 6613, Laboratoire d'Acoustique,
Avenue Olivier Messiaen, 72085 LE MANS CEDEX 9, France

(**) LUNAM Université, Ecole Centrale de Nantes, UMR CNRS 6597, IRCCyN (Institut de
Recherche en Communications et Cybernétique de Nantes),
1 rue de la Noë, BP 92101, 44321 NANTES Cedex 03 FRANCE

31/01/13

Abstract

The subjective quality of single cane reeds used for saxophone or clarinet may be very different from a reed to another although reeds present the same shape and the same strength. In this work, we propose to compare three approaches for the characterization of reeds properties.

The first approach consists in measuring the reed mechanical response (“*in vitro*” measurement) by means of a specific bench which gives equivalent dynamic parameters (mass, damping, stiffness) of the first vibration mode. The second approach deals with the measurement of playing parameters “*in vivo*“, using specific sensors mounted on the instrument mouthpiece. These measurements provide specific parameters in playing condition, such as the threshold pressure or the spectral centroid of the sounds. Finally, subjective tests are performed with a musician in order to assess the reeds according to subjective criteria, characteristic of the perceived quality.

Different reeds chosen for their subjective differences (rather difficult and dark, medium, rather easy and bright) are characterized by the three methods. First results show that correlations can be established between “*in vivo*” measurements and subjective assessments.

Table of Contents

1	Introduction.....	3
2	Subjective characterization of reeds.....	4
2.1	Method.....	4
2.2	Results.....	5
3	“In vivo” characterization.....	6
3.1	Experimental set-up.....	6
3.2	Playing parameters estimation.....	7
3.2.a	Notes detection.....	8
3.2.b	Estimation of the stationary part of a note.....	9
3.2.c	Parameters estimation during the stationary part.....	9
3.2.d	Parameters estimation during the attack.....	11
3.2.d.i	Attack threshold pressure estimation.....	11
3.2.d.ii	Attack time estimation.....	12
3.2.d.iii	Efficiency estimation.....	12
3.2.e	Repeatability.....	12
3.3	Analysis of measurements.....	13
3.3.a	Relative playing parameters estimation.....	13
3.3.b	Multivariate analysis of the playing parameters.....	16
4	“In vitro“ characterization of the reeds.....	16
4.1	Experimental set-up.....	16
4.2	Reed parameters estimation.....	20
4.3	Repeatability of the “in vitro” measurements.....	21
4.3.a	Short-term and mid-term repeatability.....	21
4.3.b	Long-term repeatability.....	23
4.4	Discussion.....	25
5	Correlations between different approaches.....	25
5.1	Comparison of subjective parameters with playing parameters.....	26
5.2	Comparison of reed parameters with playing parameters and subjective indicators.....	29
6	Conclusion.....	31

1 Introduction

The musical quality of woodwind instruments such as clarinet or saxophone depends strongly on the reed quality. Quality of single cane reed may vary from a reed to another. Using our own experience of musician, we consider that 30 % of reeds in a box are good reeds, whereas 40 % are mean quality reeds and 30 % are considered as bad. Moreover, we assume that great differences in the subjective quality perceived by the musician remain constant over long time periods (few months), such that extreme values of quality does not change over time (very bad reeds remain very bad and very good reeds remain very good).

Usually, the experimental characterization of mechanical properties is performed by measuring the mechanical stiffness of the reed, submitted to a static force at a particular location from the tip. This measurement enables to estimate the strength of the reed which is indicated on the box for the clarinet or saxophone player. It appears that this method is necessary to sort out the reeds for different strength and to indicate to the musician whether or not the reed can be played with a particular mouthpiece. However, this approach cannot explain the great differences perceived by musicians between reeds with the same strength and the same cut.

The characterization of physical properties of reeds has been studied using different approaches such as visualization of cane cells, mechanical measurement of vibration response or optical holography to identify the vibrational modes of the reed.

Kolesik [1] studies the anatomical characteristics of cane using confocal laser scanning microscopy. Mukhopadhyay *et al.* [2] proposes to characterize the quality of saxophone reeds using planar electromagnetic sensors. Obataya *et al.* [3] studies the effect of relative humidity on the dynamic Young's modulus of the reed using a free-free beam flexural vibration method and by measuring small plates made with cane. Pinard *et al.* [4] observes the vibrational modes of 24 clarinet reeds in both dry and wet conditions using holographic interferometry. Picart *et al.* [5] observes the modes of a clarinet reed using holography and measures the displacement of the reed tip during auto-oscillations created in an artificial mouth. Taillard *et al.* [6] studies the mechanical behaviour of reeds using holography. However, there is still no objective indicator that clearly explains the subjective quality of reeds.

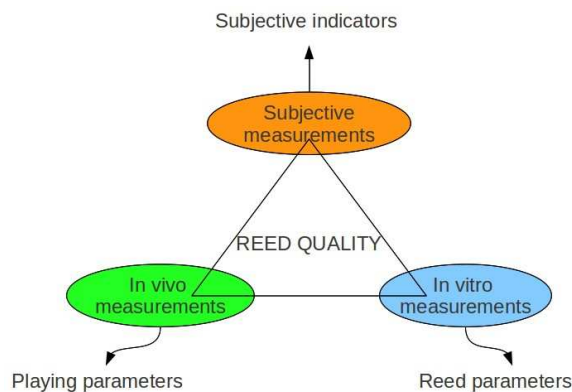

Figure 1 : Structure of the research. The different measurements categories to characterize reed quality.

The aim of this work is to explain why particular reeds produce different sounds (more or less bright) and different feeling for the player assuming that the big differences in quality remain constant over long time periods.

In our view, the analysis of reed quality can be divided in three parts as shown in Figure 1. First axis concerns the perception of the reed by musicians (subjective dimensions) and should determine the assessment of reeds according to subjective descriptors that characterize the reed musical quality.

Second axis, which deals with physical measurements performed with a player (“in vivo” measurements), enables to estimate different “playing parameters”. Last part deals with the “in vitro” measurements. It concerns the mechanical or optical characterization of the reed and enables to estimate reed intrinsic parameters.

In this paper, we use the three measurements techniques described in Figure 1 for characterizing the reed quality:

1. Subjective tests are performed to assess the reeds according to descriptors that can explain the reed musical quality.
2. The pressure inside the mouth player and the acoustic pressure emitted at the saxophone horn are measured (“in vivo” measurements). For each reed and for different notes, different playing parameters such as the mean mouth pressure and the spectral centroid of the acoustic pressure are calculated.
3. Vibro-acoustical responses of reeds are measured using an experimental system which generates a sound inside a mouthpiece at low levels compared to the levels observed during the playing (“in vitro” measurements). The reed response is estimated by measuring the displacement of the reed tip and the acoustic pressure inside the mouthpiece. “In vitro” indicators are estimated by analyzing the frequency response of the reed (resonance parameters).
4. Correlations between subjective parameters and objective (“in vivo” and “in vitro”) parameters are studied.

Following this scheme, the paper is organized as follows. Section 12 presents the subjective characterization of reeds and section 3 presents the experiments performed to estimate “in vivo” parameters. Section 4 presents the experimental system for the measurement of the mechanical parameters of the reed (“in vitro”) and gives the repeatability of the technique. Section 5 compares the subjective descriptors and the objective indicators.

2 Subjective characterization of reeds

2.1 Method

The aim of this section is to present the method for the subjective characterization of the reed. 12 reeds for tenor saxophone of the same brand, same cut and same strengths have been considered. These reeds make a series called series 1. All these reeds were played before doing the test and were not completely new. All the reeds were considered to be playable (not too hard, not too soft). The reeds were played and assessed by an experienced saxophone player. The musician used a Reference 54 Selmer saxophone and a Vandoren V16 T8 mouthpiece. 4 descriptors were defined for the assessment of the reeds:

1. Strength (this indicates the feeling of easiness of playing). A high value of the strength indicates that the reed is difficult to play.
2. Projection (this descriptor is related to the feeling of a good sound projection, corresponding to the feeling that the sound is really transferred from the instrument into the room).
3. Brightness (this descriptor is related to the feeling of a bright sound).
4. Homogeneity (this refers to the homogeneity of the reed, from the bottom to the high register).

The musician was asked to play each reed and to assess each descriptor on a 5-levels structured rating scale (from 1: low score to 5: high score). Each reed was repeated three times and the average value of each descriptor was calculated from the three evaluations. The reeds were presented in a random order. The musician was also asked to play a given musical phrase, which was recorded. The musical phrase used for the test is a descending arpeggio of 7 notes (C5 523.3 Hz, G4 392 Hz, Eb4 311.1 Hz, C4 261.6 Hz, G3 196 Hz, Eb3 155.6 Hz, C3 130.8 Hz). For each reed, the arpeggio has been played five times (5 repetitions) in order to estimate the average and the standard deviation of the different objective parameters.

2.2 Results

The average subjective evaluations of the 12 reeds (individuals) according to the 4 descriptors (variables) were analysed using standardized Principal Components Analysis. The two first factors of PCA represent 91.18 % of variance, so the evaluations can be considered as bi-dimensional. Figure 2 represents the contribution of the variables, and Figure 3 the position of the reeds. The first factor is mainly created by the descriptors brightness, projection and homogeneity, which are correlated. The second factor is created by the descriptor strength. Typical reeds on the first factor are a6 and a7, which are very "bright", "homogeneous" and "project", opposed to the reeds a66 and a75. Typical reeds on the second factor are a79, very "stiff" and a21, very "flexible".

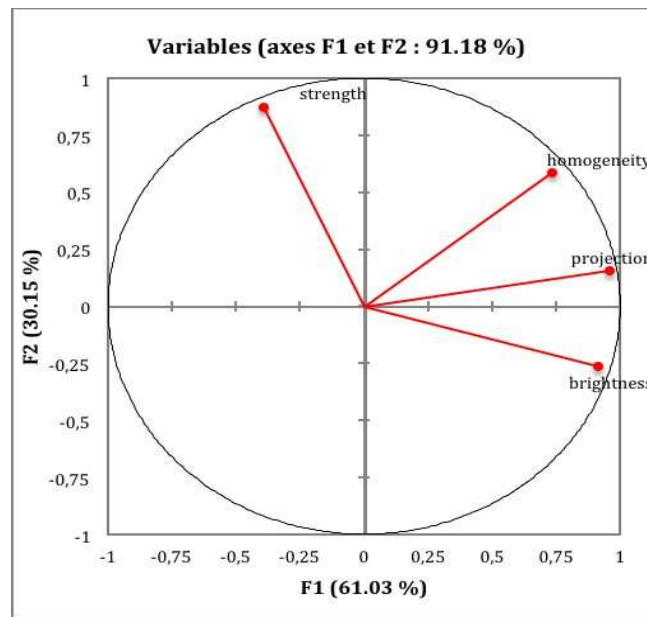

Figure 2: Principal Component Analysis of the subjective assessments of the reeds. (plane of the variables)

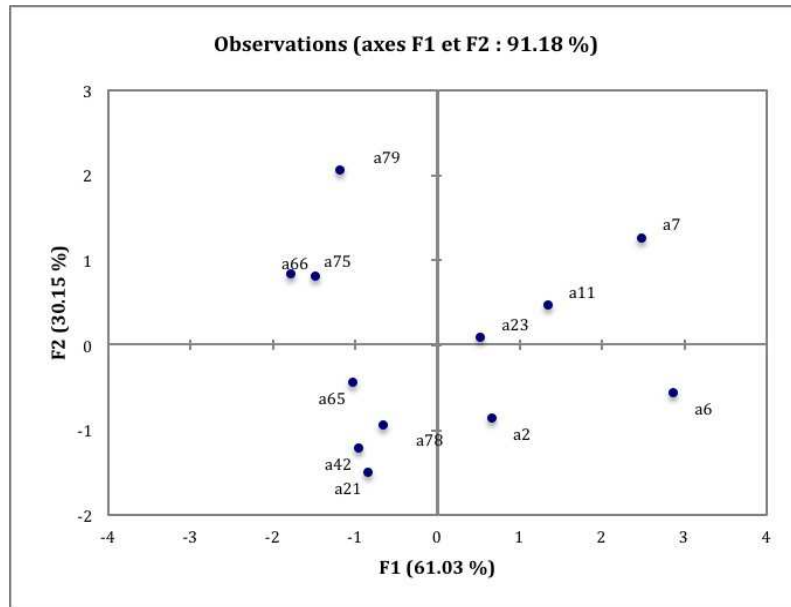

Figure 3: Position of the reeds according to the 2 first factors of PCA.

3 “In vivo” characterization

The aim of this experiment is to provide measurements of the reeds in playing conditions.

3.1 Experimental set-up

The experimental system enables us to measure the (static) pressure P_m in the mouth of the musician and the radiated acoustic pressure at the saxophone bell Par. The mouth pressure is measured using a differential pressure sensor Endevco 8507-C2. The acoustic pressure is measured using a 1/4 inch microphone (B&K 4135) placed in front of the saxophone bell (Figure 4). The signals are connected to an acquisition board National instruments BNC-2110 using a sampling frequency $F_s = 50$ kHz.

An example of measured signal is shown in Figure 5. This signal has been obtained by playing without any tongue attack.



(A)

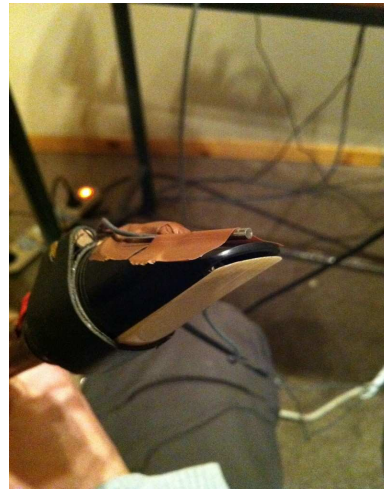

(B)

Figure 4 : View of the “in vivo” measuring system. (A) : measurement of the radiated acoustic pressure. (B) Measurement of the mouth pressure.

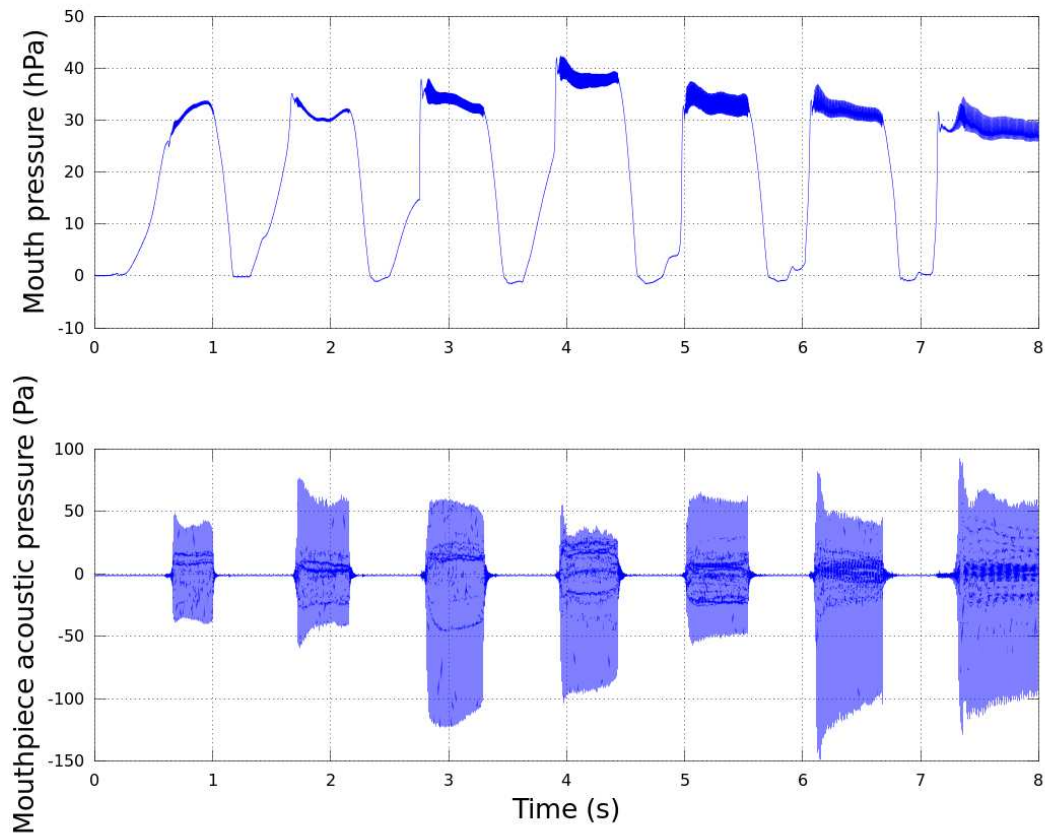

Figure 5: Example of signal measured when the musician is playing the 7 notes arpeggio: (top) Mouth pressure ; (bottom) Acoustic pressure at the saxophone horn output.

3.2 Playing parameters estimation

The signals measured “in vivo” are used to estimate the playing parameters, *i.e.*, parameters associated

to the mouth pressure and parameters associated to the radiated acoustic pressure. These parameters are calculated by analysing separately the transient part of the sound and the stationary part of the signal. The general scheme used for this estimation is the following:

- Notes detection using a threshold applied on the radiated pressure envelope
- For each note
 - (a) Detection of the stationary part of the note.
 - (b) Parameters estimation on the stationary part (Mean Mouth Pressure, acoustic pressure parameters).
 - (c) Parameters estimation on the transient (Threshold pressure, attack time).
 - (d) Efficiency estimation.

3.2.a Notes detection

In a first step, each note is detected by using a threshold applied on the acoustic radiated pressure envelope. The envelope is estimated by convolving the acoustic pressure $p_{ar}[n]$ with a Hanning window $W[k] = \frac{1}{2} \left(1 - \cos \frac{2\pi k}{N}\right)$ of length T_w , defined by $T_w = \frac{1}{F_c}$, where F_c is the cut-off frequency. In our case, $F_c = 20 \text{ Hz}$. The comparison of the normalized envelope $E_{ar}[n] = \frac{p_{ar}[n] * W[n]}{\max(E_{ar}[n])}$ with a threshold enables us to deduce the beginning time t_b and ending time t_e of each note as shown in Figure 6. The threshold value is chosen empirically by analysing different recorded signals.

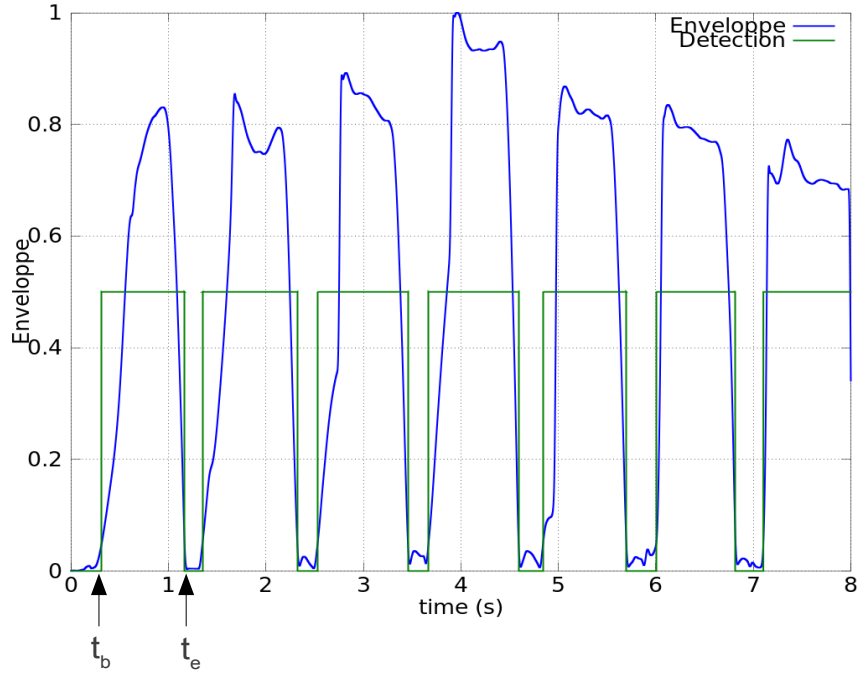

Figure 6 : View of the note detection using the threshold applied on the normalized envelope of the radiated acoustic pressure. View of beginning time t_b and ending time t_e for the first note.

3.2.b Estimation of the stationary part of a note

For each note, the stationary part of the signal is estimated by calculating the energy of the signal $p(t)$ $E(t)$

$$E(t) = \int p_{ar}^2(t) d\tau. \quad (1)$$

The stationary part of the signal is defined for $E(t) \in [0.1, 0.9] E_{max}$, where E_{max} is the maximum energy obtained at the end of the note.

3.2.c Parameters estimation during the stationary part

Once the stationary part of the signal has been detected, the following parameters are estimated :

- Harmonic Spectral Centroid (HSC)
- Odd Harmonic Spectral Centroid (OHSC)
- Even Harmonic Spectral Centroid (EHSC)
- Odd/Even Ratio (OER)
- Tristimulus, 1st coefficient (TR1)
- Tristimulus, 2nd coefficient (TR2)
- Tristimulus, 3rd coefficient (TR3)

- High Frequency Components (HFC4)
- Mean Mouth Pressure (MMP)

The estimation of the harmonic spectral centroid is performed as follow. The harmonic spectral centroid $HSC(n,r)$ is estimated for each reed r and each note n by using 45 harmonics of the signal for each note using

$$HSC(n,r) = \frac{1}{f_1} \frac{\sum_{k=1}^{k=45} A_k f_k}{\sum_{k=1}^{k=45} A_k}, \quad (2)$$

where f_k is the frequency and A_k is the amplitude of the spectral component k obtained using a DFT. The calculation is performed using 45 harmonics in order to use the same number of harmonics for each note, the number of harmonics being limited by the maximum frequency (25 kHz) for higher notes.

The estimation of $OHSC$ and $EHSC$ are performed as follow

$$OHSC(n,r) = \frac{1}{f_1} \frac{\sum_{h=0}^{h=22} A_{2h+1} f_{2h+1}}{\sum_{h=0}^{h=22} A_{2h+1}}, \quad (3)$$

$$EHSC(n,r) = \frac{1}{f_1} \frac{\sum_{h=1}^{h=22} A_{2h} f_{2h}}{\sum_{h=1}^{h=22} A_{2h}}, \quad (4)$$

and OER is estimated by

$$OER(n,r) = \frac{\sum_{h=0}^{h=22} A_{2h+1}^2}{\sum_{h=1}^{h=22} A_{2h}^2}. \quad (5)$$

As we are using only the stationary part of the signal, the b_0 parameter described in [8] to prevent the descriptor from tending to infinity when noise predominates is not used here.

The parameters $TR1$, $TR2$, $TR3$ and $HFC4$ are estimated as follow,

$$TR1 = \frac{A_1^2}{\sum_{k=1}^{k=45} A_k^2}, \quad (6)$$

$$TR2 = \frac{\sum_{k=2}^4 A_k^2}{\sum_{k=1}^{k=45} A_k^2} \quad (7)$$

$$TR3 = \frac{\sum_{k=5}^{45} A_k^2}{\sum_{k=1}^{45} A_k^2} \quad (8)$$

$$HFC4 = \frac{\sum_{k=k_0}^{45} A_k^2}{\sum_{k=1}^{45} A_k^2} \quad (9)$$

where $f_{k_0} > 4 \text{ kHz}$, which means that $HFC4$ corresponds to the ratio between the energy of harmonics which frequency is higher than 4 kHz and the total energy.

The mean mouth pressure MMP is estimated as the mean value of the pressure measured in the mouth during the stationary part of the signal. It is defined by

$$MMP = \frac{1}{t_e - t_b} \int P_m(t) dt, \quad (10)$$

where $P_m(t)$ is the mouth pressure.

3.2.d Parameters estimation during the attack

3.2.d.i Attack threshold pressure estimation

The detection aims at determining the time at which the acoustic pressure measured at the saxophone bell shows a periodic component at the fundamental frequency of the played note, this frequency being a priori known by analyzing the whole signal over the note duration. For this, the detection function defined by

$$D(t) = \frac{\sqrt{A(t)^2 + B(t)^2}}{\max[\sqrt{A(t)^2 + B(t)^2}]} \quad (11)$$

with

$$A(t) = \int_0^T p_{ar}(t) \cos 2\pi f_0 t dt, \quad (12)$$

$$B(t) = \int_0^T p_{ar}(t) \sin 2\pi f_0 t dt, \quad (13)$$

where $p_{ar}(t)$ is the acoustic pressure and f_0 is the estimated fundamental frequency. The comparison between indicator $D(t)$ and a threshold value enables to deduce the threshold pressure time t_p of the note as shown in Figure 7.

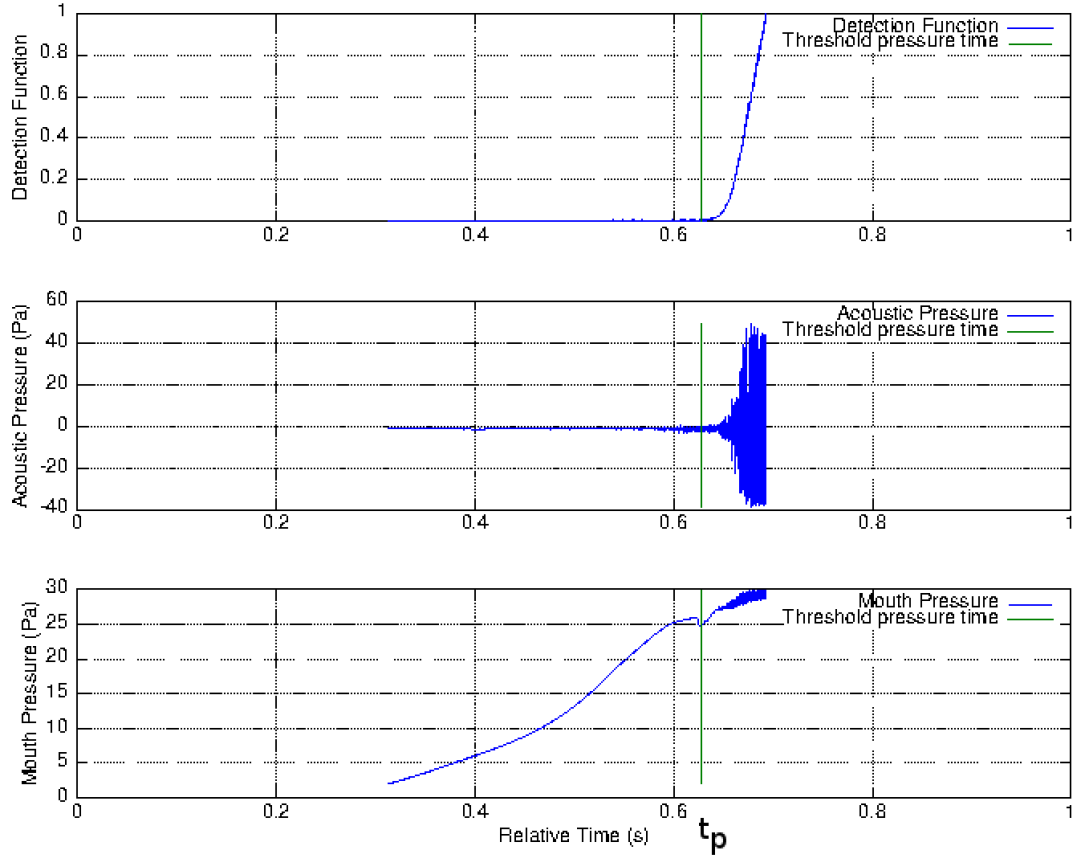

Figure 7: Principle of estimation of the threshold pressure using the detection function.

3.2.d.ii Attack time estimation

The Attack Time (AT) is given by

$$AT = t_{ae} - t_{ab} \quad (14)$$

where t_{ab} and t_{ae} are the start and end of the attack times, respectively. They are defined as in [9], as the times at which the Root Mean Square (RMS) envelope attains 10 % and 90 % of its maximum value, respectively. For real signals, these parameters can be difficult to estimate because of the shape of the envelope which can be different from a monotonous increase.

3.2.d.iii Efficiency estimation

We propose to estimate the efficiency of reed r and note n using

$$Eff(n, r) = \frac{\sqrt{\sum_{k=1}^{45} A_k^2}}{MMP}, \quad (15)$$

where $\sqrt{\sum_{k=1}^{45} A_k^2}$ represents the acoustic pressure Root Mean Square amplitude and MMP the Mean Mouth Pressure described above (Eq. 10).

3.2.e Repeatability

The repeatability in the parameters measurement is estimated by calculating the uncertainty $u(n, r)$ of

the measurement for note n and reed r using 95 % confidence interval.

$$u(n, r) = \frac{2.57}{\sqrt{5}} \frac{\sigma_p}{\bar{p}}, \quad (16)$$

where \bar{p} is the mean value of parameter p over the 5 measurements and σ_p is the standard deviation of parameter p over the 5 measurements.

Figure 8 shows the mean relative error calculated over the 12 reeds of series 1 for the different indicators and the different notes. Figure 8 shows that the relative error on the absolute parameters is less than 10 % except for indicators TR3, TR1 and HFC4. The relative error is much greater for note C3 which is the lower note played in the musical phrase, except for indicators MMP and threshold pressure for which the uncertainty remains almost equal to 5 %. This result shows that the lowest note of the phrase C3 should not be taken into account during the analysis because of the big uncertainty that this note creates on indicators. This result is not surprising for saxophone players because the playing of this note is risky on the saxophone which creates a bigger variance on the indicators.

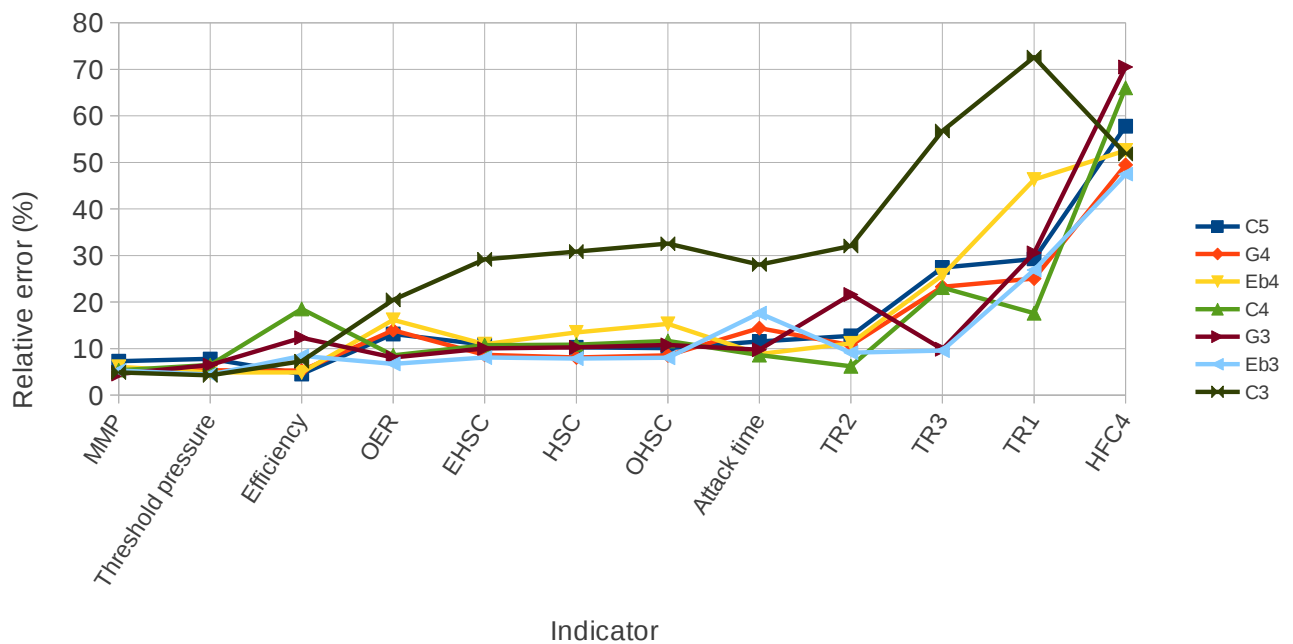

Figure 8: Mean relative error calculated over the different reeds and for the 7 notes according to “in vivo” indicators.

3.3 Analysis of measurements

This section presents the results obtained with the “in vivo” measurements. We first present the method used to allocate a single value of each indicator to a single reed. These indicators are called relative playing parameters. Then the multivariate analysis of the relative playing parameters is presented to estimate how many dimensions describe the “in vivo” parameters.

3.3.a Relative playing parameters estimation

Once the parameters described above are estimated, they show a great variance for different notes and different reeds. The musical phrase used in this section is an arpeggio of 7 notes.

The estimated mean values of the spectral centroid (HSC) and mouth pressure (MMP) calculated over the 5 measurements and obtained in the “*in vivo*” configuration are presented in Figure 9 and Figure 10 for the 7 notes (C5 523.3 Hz, G4 392 Hz, Eb4 311.1 Hz, C4 261.6 Hz, G3 196 Hz, Eb3 155.6 Hz, C3 130.8 Hz) played on the saxophone. Both parameters show a significant dependence on the played note. HSC values are increasing while the fundamental frequency of the note is decreasing. MMP is symmetric around note C4, showing greater values for the note C4. Nevertheless, we notice that the interaction between the note played and the reed used is weak (the different curves are rather parallel).

This behavior enjoins us to use the average value of the parameter along the different notes to characterize the reeds.

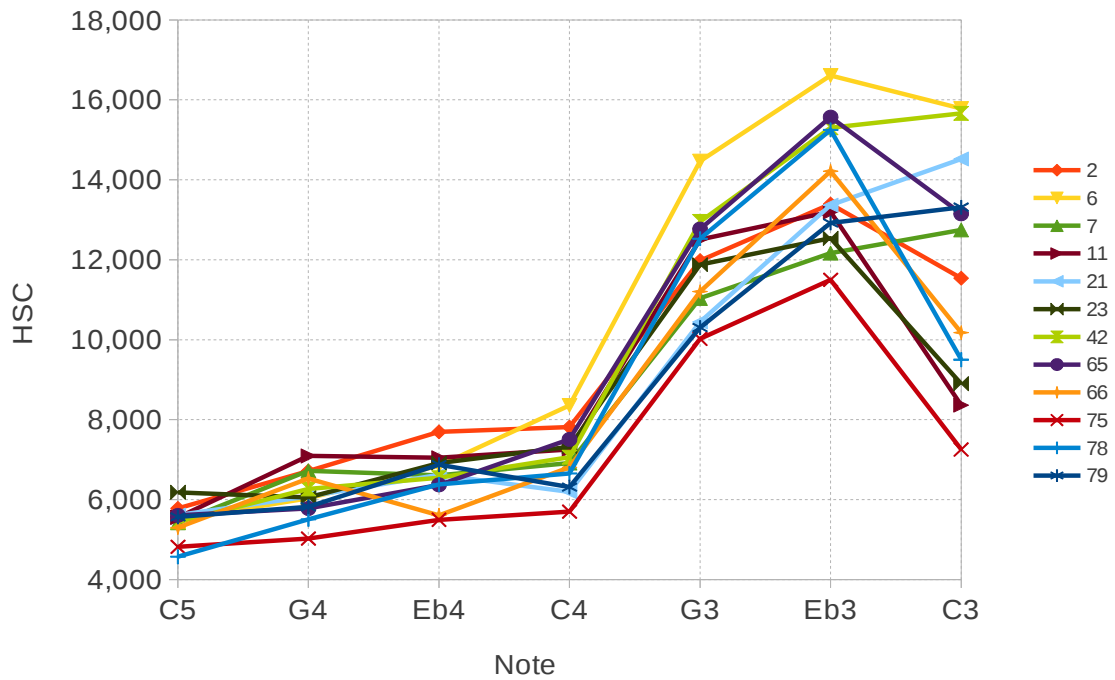

Figure 9 : View of the estimated Harmonic Spectral Centroid as a function of the note number for the different reeds. The figure represents the mean value calculated over the 5 measurements.

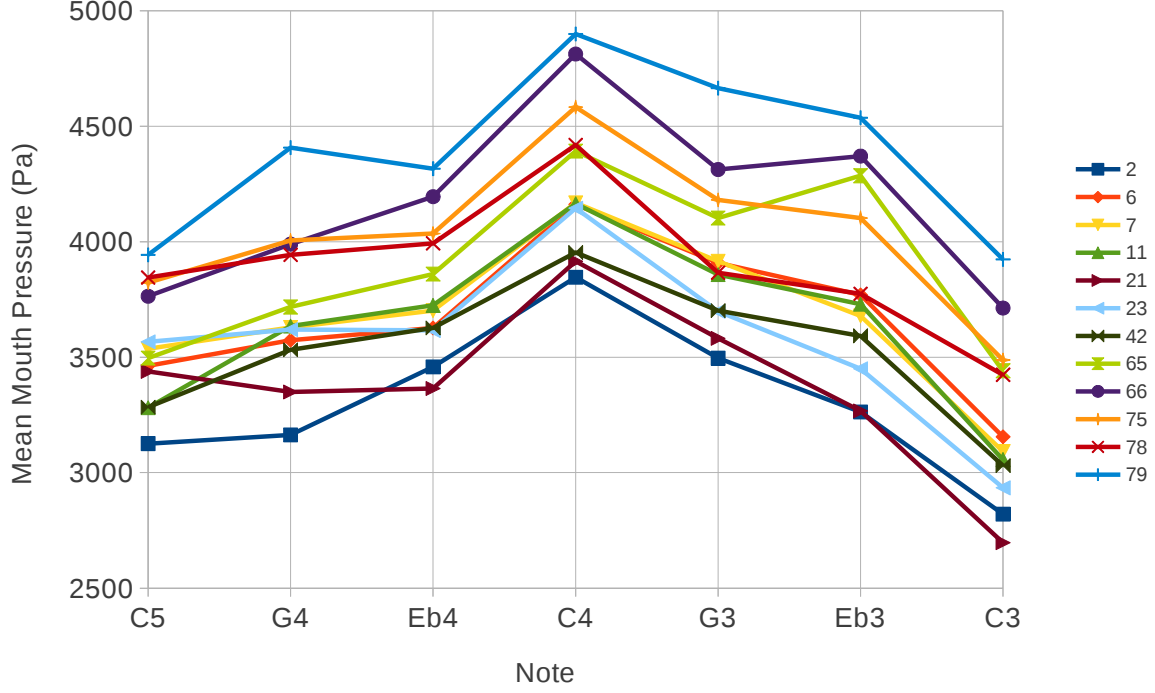

Figure 10: View of the estimated Mean Mouth Pressure as a function of the note number. The figure represents the mean value calculated over the 5 measurements.

In order to normalize the "in vivo" parameters according to the note number, we use relative parameters. For example, the relative harmonic spectral centroid (RHSC) is defined as

$$RHSC(n,r)=(HSC(n,r)-AHSC(n))/AHSC(n), \quad (17)$$

where $AHSC(n)=\frac{1}{N_r}\sum_{r=1}^{r=N_r}HSC(n,r)$ is the average harmonic spectral centroid for N_r reeds, n is the note number, r the reed number and N_r the number of reeds.

For other parameters P , the relative parameter RP is defined in the same manner

$$RP(n,r)=(P(n,r)-AP(n))/AP(n), \quad (18)$$

where $AP(n)=\frac{1}{N_r}\sum_{r=1}^{r=N_r}P(n,r)$ is the average parameter for N_r reeds.

Finally, we calculate a single parameter depending only on the reed number. For example, the Mean Relative Harmonic Spectral Centroid (MRHSC) is defined by

$$MRHSC(r)=\frac{1}{N_n}\sum_{n=1}^{n=N_n}RHSC(n,r), \quad (19)$$

where N_n is the total number of notes. For other parameters, the Mean Relative Parameter is calculated using the same approach.

3.3.b Multivariate analysis of the playing parameters

The mean relative parameters of the 12 reeds were analyzed using standardized Principal Components Analysis. Only 9 variables were considered, the 3 variables MRTR1, MRTR3 and MRHFC4 being omitted due to great uncertainty (see figure 8) :

- Mean Relative Harmonic Spectral Centroid (MRHSC)
- Mean Relative Odd Harmonic Spectral Centroid (MROHSC)
- Mean Relative Even Harmonic Spectral Centroid (MREHSC)
- Mean Relative Odd/Even Ratio (MROER)
- Mean Relative Tristimulus, 2nd coefficient (MRTR2)
- Mean Relative Mouth Pressure (MRMP)
- Mean Relative Pressure Threshold (MRPTh)
- Mean Relative Efficiency (MREff)
- Mean Relative Attack Time (MRAT)

Figure 21 shows the Principal Component Analysis of the “in vivo” parameters. The two first factors of PCA represent 78 % of the variance. The analysis of this figure shows that there are mainly two families of parameters :

- the variables related to the high frequency components of the sounds (MRHSC, MROHSC, MREHSC.). These variables contribute to the creation of the first factor. We notice that MRTR2 , which concerns the low frequency components, is opposite to this group of variable, which is coherent).
- the variables relative to the pressure and attack time (MRPTH, MRMP, MRAT). The variables MREff and MROER are opposed to these variables.

4 “In vitro” characterization of the reeds

This section presents the vibro-acoustic bench used for characterizing the equivalent mechanical parameters of tenor saxophone reeds at a low sound pressure level (typically about 100 dB SPL) compared with the acoustic level observed in real playing conditions (140 to 160 dB). We present the principle of the bench (experimental system) and the method used to estimate the reed parameters estimation. Then the repeatability of the measurement are presented for different configurations (with or without artificial lip, short term and long-term measurements).

4.1 Experimental set-up

All the measurements were performed using the experimental set-up shown in Figure 11. The reeds are dry for the measurement but the hygrometry is not controlled so that the reed moisture follows the ambient air's moisture.

The reed is mounted on a tenor saxophone mouthpiece using a cap. The mouthpiece cavity is excited with a small loudspeaker. The acoustic pressure exciting the reed p is measured using a 1/8 inch

microphone (B & K 4138) at 5 mm from the tip of the mouthpiece. The reed displacement y is measured using an optical sensor (Philtec RC 25) having a measuring area of about 1 x 4 mm. This sensor is mounted on a traverse system which enables us to set precisely the distance between the reed and the sensor (as the optical sensor response is non linear, the distance between sensor and reed must be known and determines the functioning point of the optical sensor). For all the experiments, the response of the reed is characterized by measuring the Frequency Response Function displacement over acoustic pressure at the middle of the reed (in the transverse direction) and at 2 mm from the tip.

Sine sweeps were generated using personal computer and sent to a loudspeaker via an amplifier. Microphone and displacement sensor signals were recorded in the PC using data acquisition board. This set-up is exactly the same as the one used previously by [10]. Great care was taken to place each reed at exactly the same position vertically and horizontally. Displacement sensor was always placed two millimeters below the tip of the reed and every time at exactly the same distance from the reed. Moreover, an artificial lip was constructed using thin silicon strip mounted to a rigid supporting frame. Strip was 3cm wide, 7mm tall and 4mm thick. It was attached to a thin horizontal beam which was there to model the effect of the musician's teeth. For the measurements using the artificial lip, the lip was always positioned at the same vertical distance from the tip of the reed. Force between the lip and the reed was measured using the FSR (force sensing resistor) sensor and was always set to the same value, similar to the value obtained when measuring the force between the real lip and the reed on the playing musician.

Examples of reed response are shown in Figure 12 and Figure 13 without the use of the artificial lip. This response show a marked first resonance mode which is slightly damped and higher modes which are more strongly damped. First mode corresponds to the first flexural mode, second mode is the first torsional mode and higher modes combine flexural and torsional effects as already shown by [11].

Examples of compliance measurements made with the artificial lip are presented on Figure 14 and show that the first reed resonance is strongly damped as observed in [12] and [13]. However the second strong resonance observed by Silva *et al* on a artificial mouth does not appear in our experiment.

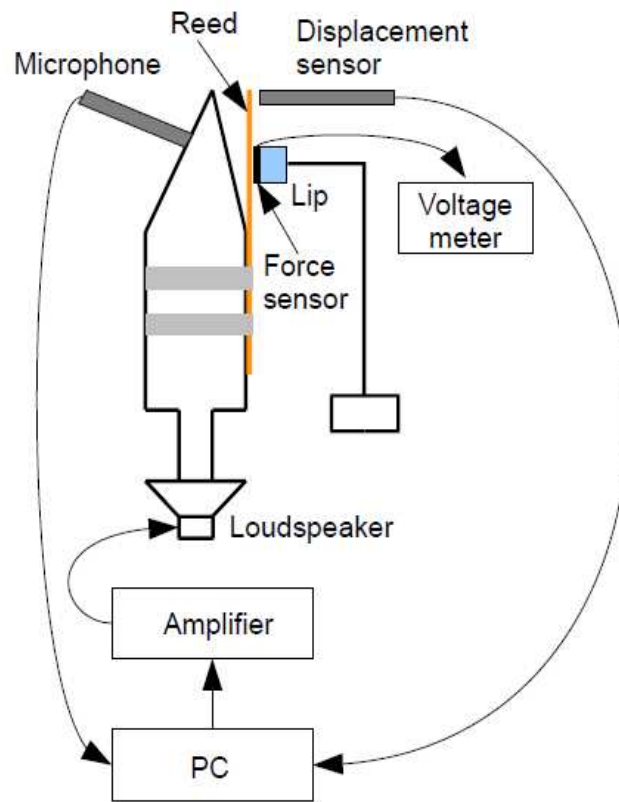

Figure 11: In vitro experimental set-up for the measurement of the frequency response function of the reed

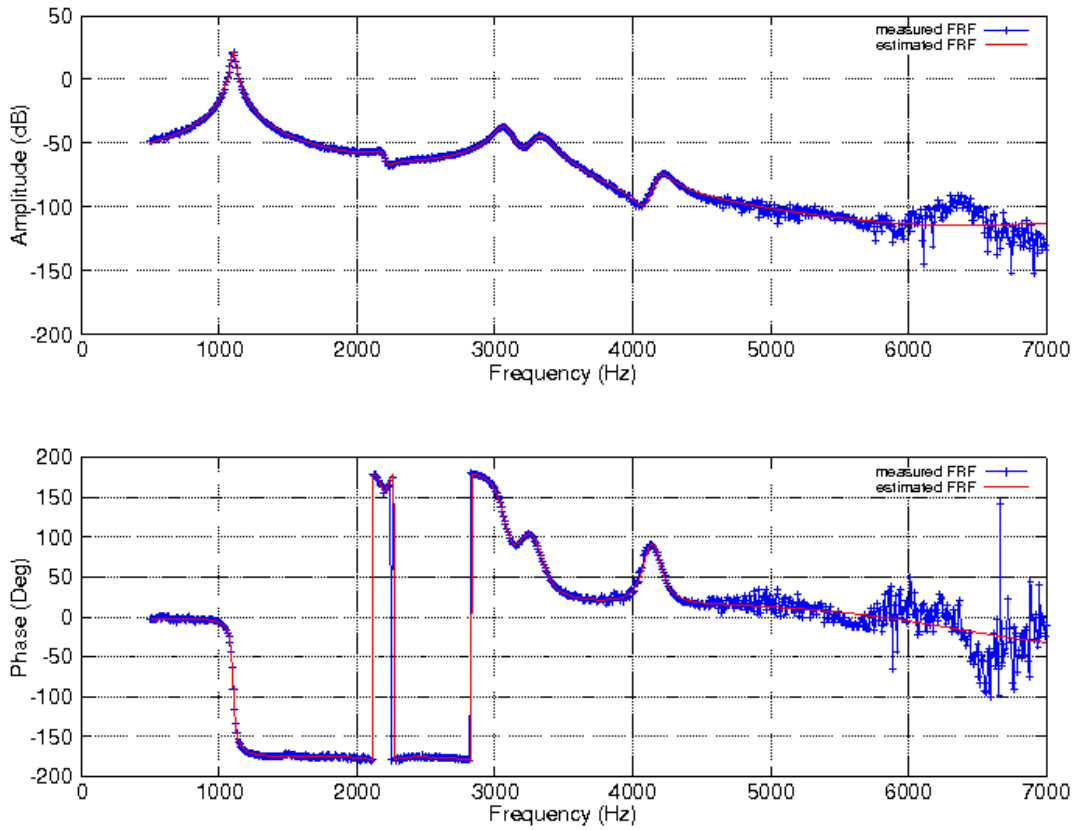

Figure 12: Example of compliance measurement without the use of artificial lip. View of the measured data (+) and the estimated data (-) using the least mean square method.

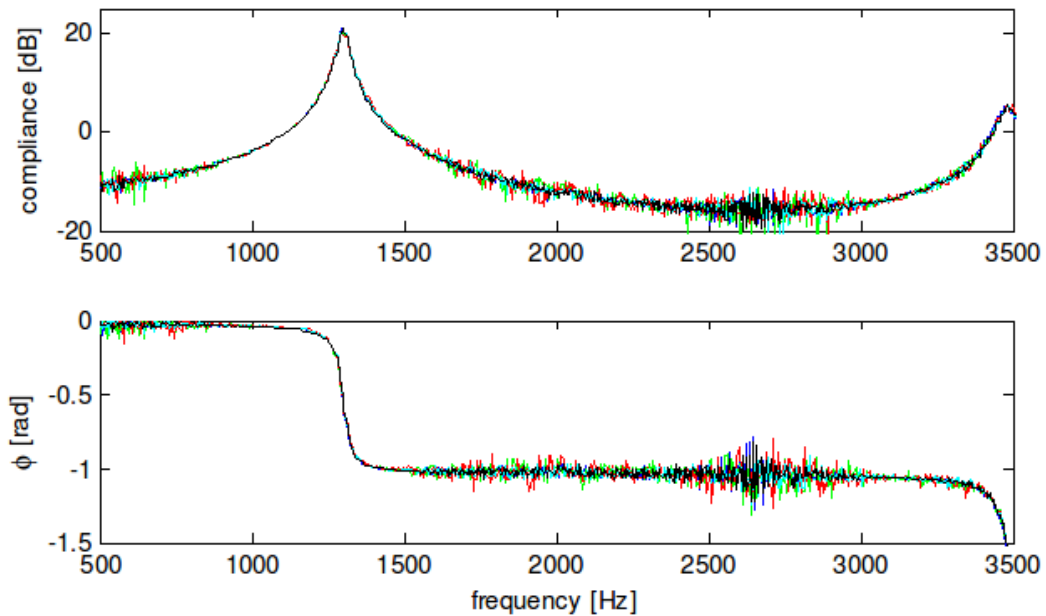

Figure 13: Example of compliance measurement without the use of artificial lip.

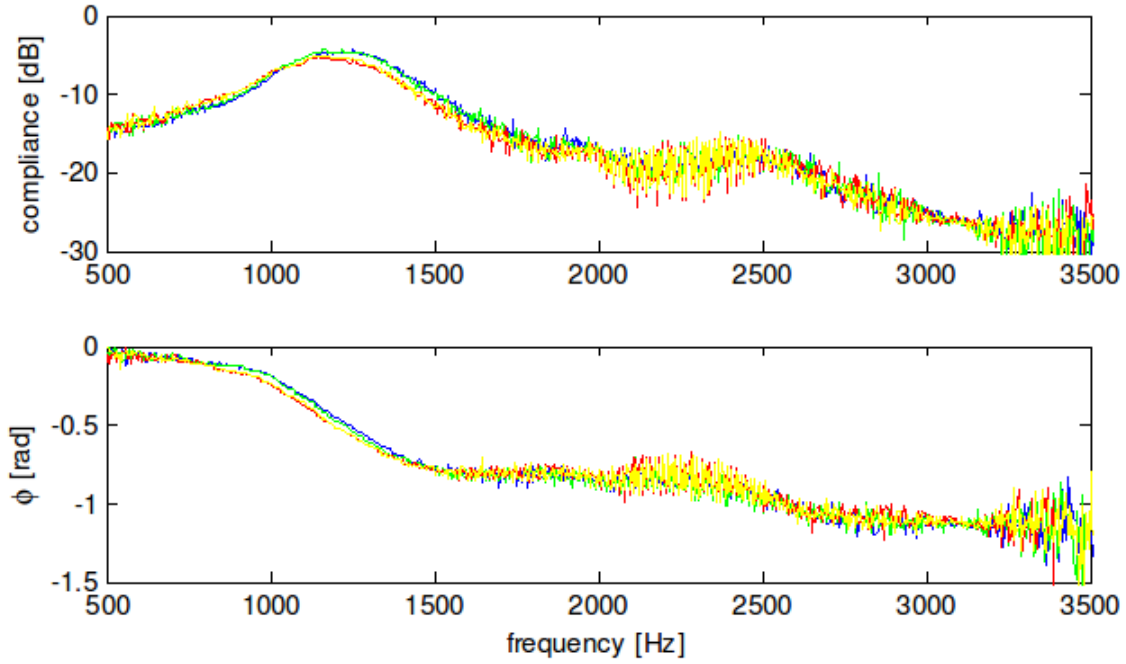

Figure 14: Example of compliance measurement with the use of artificial lip.

We can notice that this experimental system is very simple compared to other experiments using holography. It does not enable to perform easily a modal analysis of the reed as the system presented for example in [4] and [6]. However, if the physical parameters estimated from this measuring apparatus can explain (even partially) the reed quality, it could be used in the future for industrial applications.

4.2 Reed parameters estimation

The estimation of the reed parameters is done by writing the reed response as a sum of well separated modes:

$$FRF(\omega) = \frac{y(\omega)}{p(\omega)} = \sum_{k=1}^N \frac{\frac{1}{m_k}}{\omega_k^2 - \omega + j \frac{\omega}{\omega_k Q_k}}, \quad (20)$$

where m_k is the equivalent mass, ω_k is the resonance frequency and Q_k is the quality factor associated with mode k .

A least mean square method described in [14] enables to deduce the equivalent parameters of the reed for each resonance frequency (mode). An example of the reconstructed function is shown in Figure 12. In this figure blue crosses show the measured FRF and the red line shows the reconstructed FRF using the method described in [14]. This enables to deduce the reed parameters, compliance, mass, resonance frequency and quality factor for each mode. In the following, we are interested only in the first mode of the reed.

4.3 Repeatability of the “in vitro” measurements

This section presents the study of the measurement repeatability. As we assume that the reed perceived quality is constant over a long time, we wish to know if the “in vitro” measurement technique is repeatable over a long time also.

A series of fourteen different reeds was used for the experiments (series 2). Three sets of measurements were made over a time period of one week (three different days). For each set, the frequency response of each reed was measured several times with and without the use of artificial lip. This way we can compare the results from the measurements made over a time span of few minutes (short term repeatability), compare the results from the measurements made over a time span of few days (mid term repeatability) and also, by comparing our results with the several months old results, we can obtain the long term repeatability.

Four different parameters (resonance frequency, quality factor, mass and stiffness) were obtained for every reed and every measurement from the frequency response curve by means of modal analysis. First we focus on the short-term and the mid-term repeatability.

4.3.a Short-term and mid-term repeatability

A total of nine measurements were taken for each reed without the use of the artificial lip (five measurements first day, three measurements three days later and one more measurement another three days later). From the measurements done at the same day, mean values and standard deviations are calculated for each reed. In Figure 15, relative Q-factor vs relative stiffness and in Figure 16, relative resonance frequency vs relative mass are plotted. Relative value of each parameter of i -th reed measured on j -th day is represented in 2-D space by a ‘plus’ sign (+) corresponding to the relative mean values of its estimated parameters. Around the (+) sign an ellipse which major and minor radii represent standard deviations in their respective parameters is plotted. Measurements taken on different days are represented by different colours (five measurements in black, 3 measurements in blue, and 1 measurement in red).

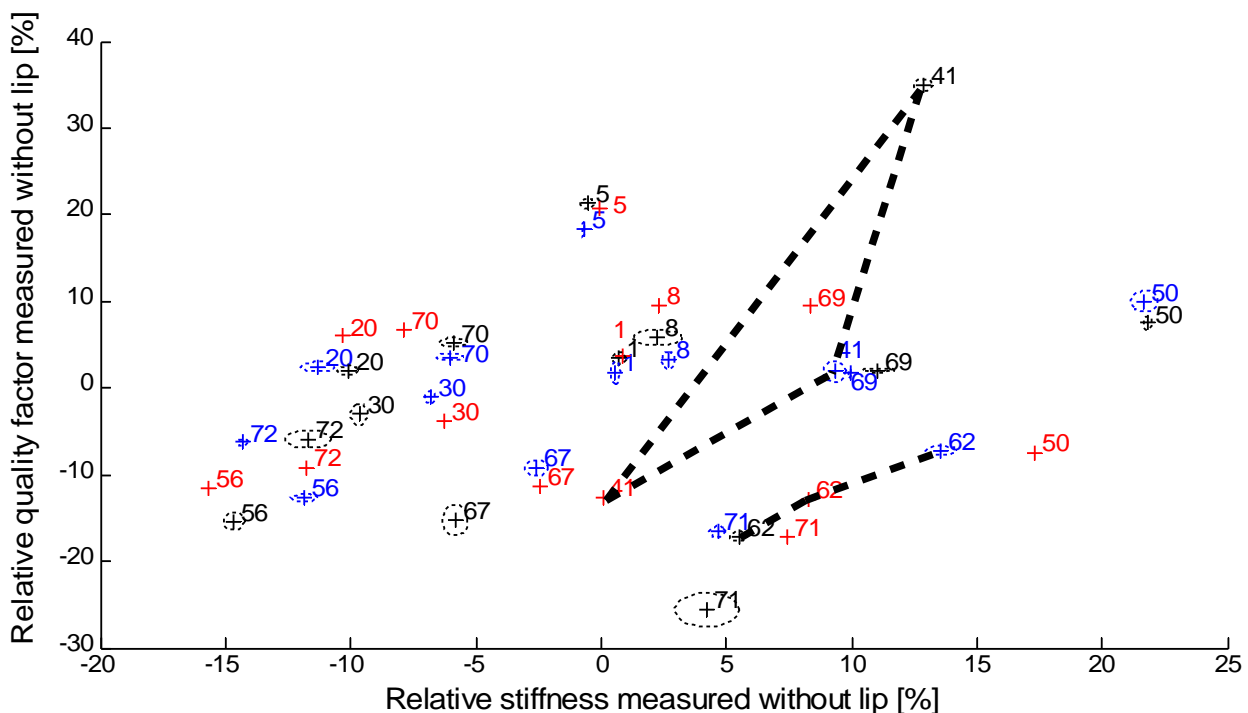

Figure 15: Relative quality factor vs relative stiffness measured without the use of the artificial lip.

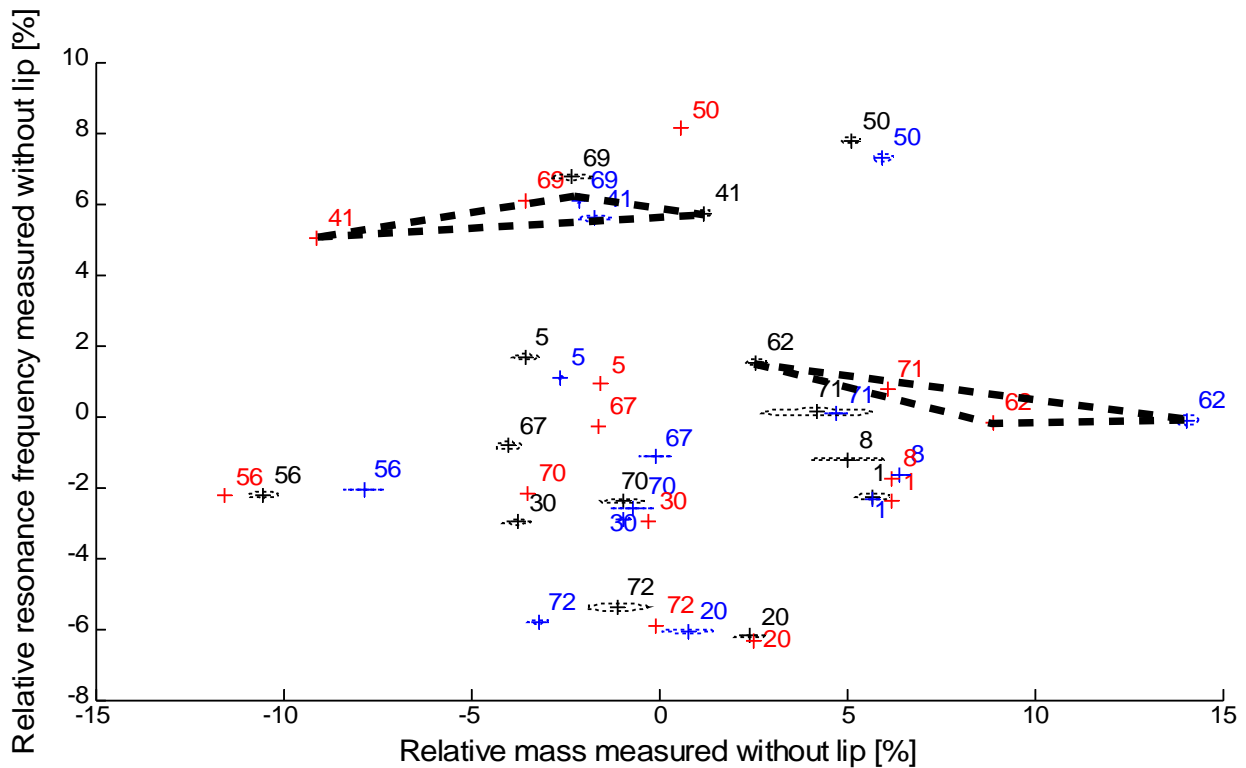

Figure 16: Relative resonance frequency vs relative mass measured without the artificial lip.

We can observe that short-term measurement (estimation) repeatability is generally very good and standard deviations are relatively small. Mid-term repeatability is slightly worse. With some reeds (1, 5, 8, 20) it is very good. With the rest of the reeds, the results are still quite repeatable. For two reeds the results cannot be considered as repeatable (blue, red and black results differ for reeds 41 and 62 on Figure 15). Indeed we observe variations of about 10 % for reed 62 on stiffness, mass and quality factor. For reed 41, the variation in the stiffness is about 15 %, in the quality-factor 50% and in the mass 10%). We assume that these two reeds might have been damaged due to previous excessive use. All these results hold for estimation of mass, stiffness and quality factor. The only parameter for which short-term and mid-term repeatability is generally excellent for all the reeds is the resonance frequency.

In Figure 17 and Figure 18, results of the measurements with the use of the artificial lip are presented. Measurements were performed with the force sensor (FSR) always placed between the reed and the lip and the lip pressure (force) was always set on the same value. The lip was always placed at the same vertical distance from the tip of the reed. A total of five measurements has been performed (four measurements first day and one more measurement three days later). It is obvious that compared to the measurements without the use of the artificial lip, short term repeatability of the measurements with the use of the lip is worse (standard deviations are larger). Mid-term repeatability is even worse and it is questionable whether these results could be used to characterize a reed. Mid-term measurement (estimation) of mass and resonance frequency is not repeatable at all and it is not clear to us why we get such a big variation for these two parameters (for example we observe a variation of the estimated mass of 80 % between the two measurements for reed 56). It seems that several non-mastered factors influence the measurements and that these measurements cannot characterize the reed. At best we can say that under these measuring conditions, some reeds (for ex. 69) are stiffer than others (for ex. 70).

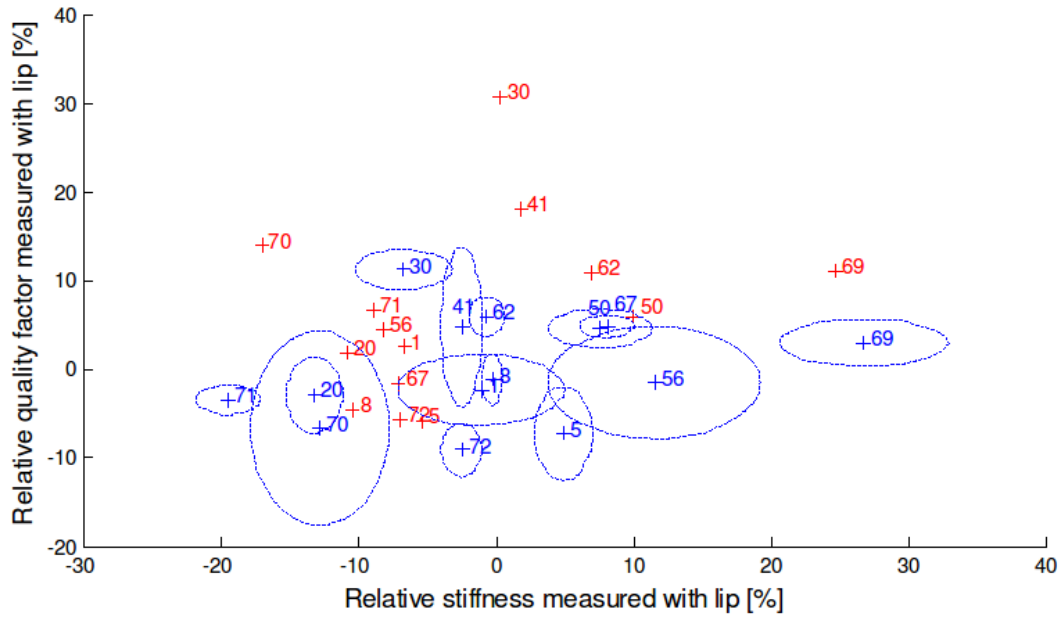

Figure 17: Relative quality factor vs relative stiffness measured with the artificial lip. Mid-term repeatability

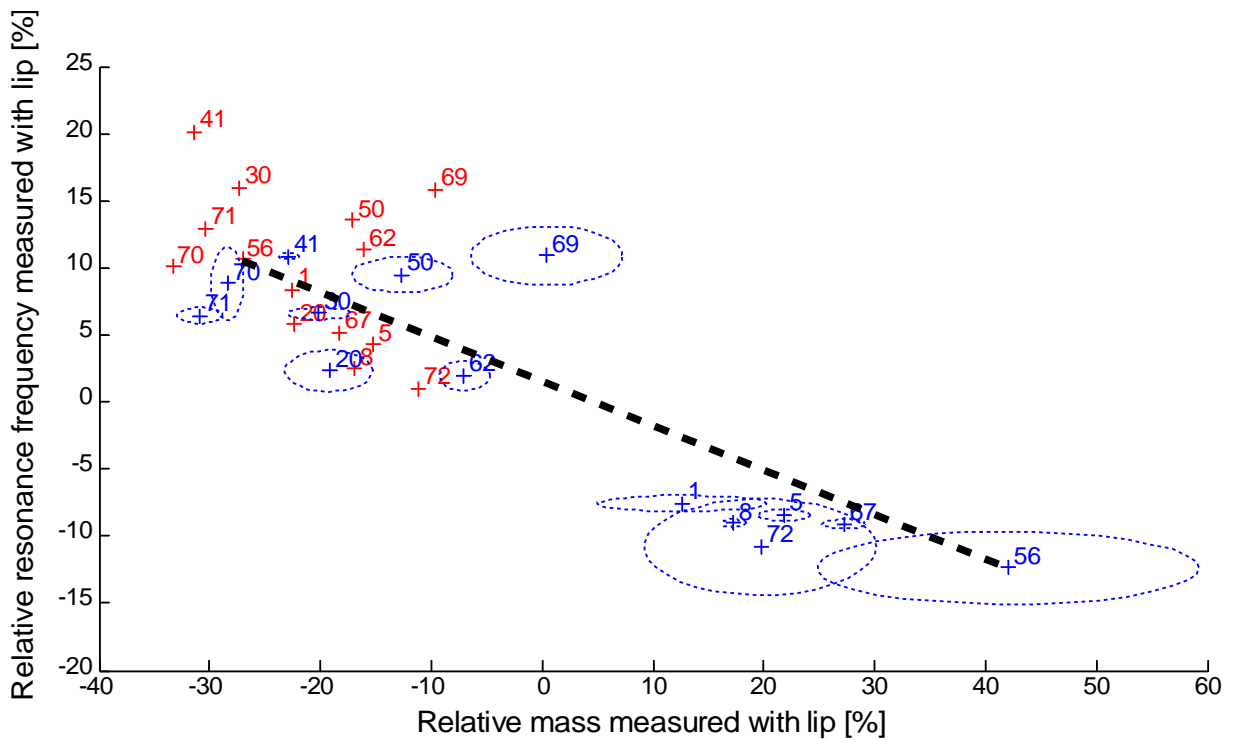

Figure 18: Relative resonance frequency vs relative mass measured with the artificial lip.

4.3.b Long-term repeatability

To estimate the long-term repeatability, we compared our results from the measurements without the artificial lip with the data obtained in [10], corresponding to measurements six month earlier. In Figure 19, new vs old measurements of stiffness and mass are presented. Only mean values of the estimated parameters are shown. Mean values of the first set of five measurements (measured in the first day) were used for comparison. Because the old measurement results and new measurement results differ significantly in their absolute values, they were normalized by their respective mean values so they can

be pictured in the same graph. Figure 19 and Figure 20 reveal that there is no obvious relationship between old and new results and it is clear that the repeatability of the measurements is very weak. Moreover, all parameter values were shifted significantly. Except for quality-factor, all other parameters were changed significantly. Old measurements were made six months before our measurements, reeds were not played during this time and were kept in dry conditions. It is not clear whether it is the amount of water contained in the reed or some other factor, but it is clear that dynamical parameters of the first resonance change greatly with time.

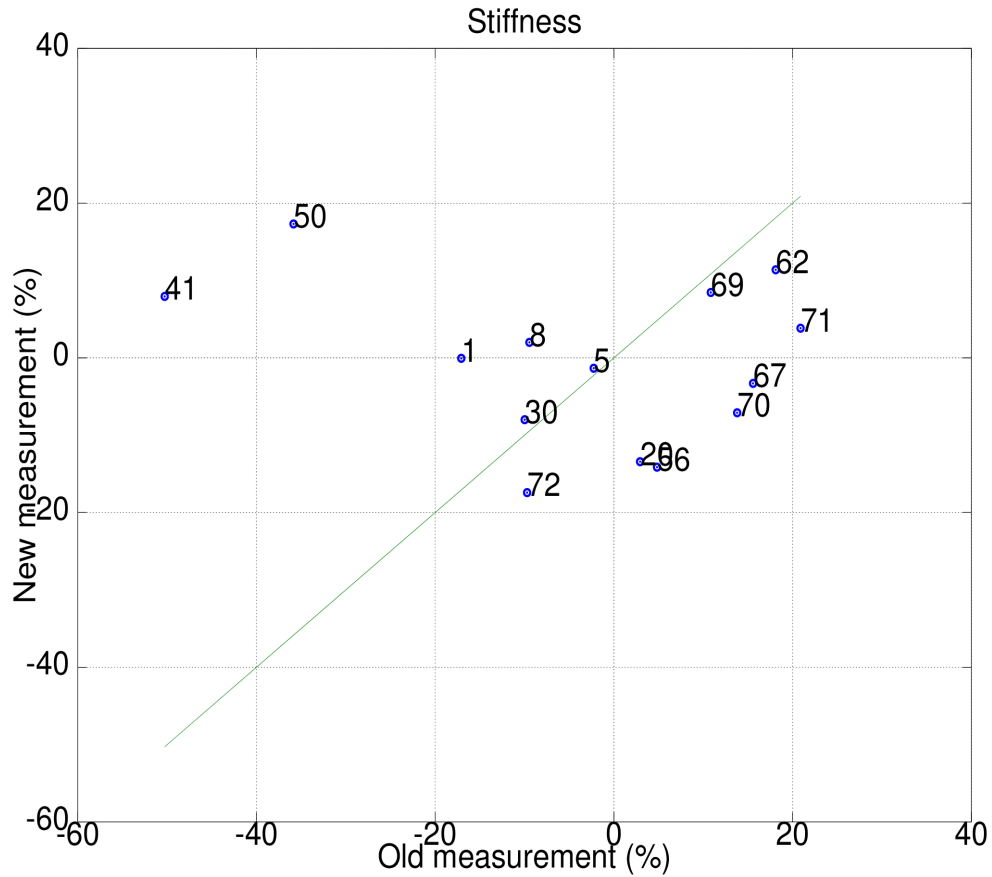

Figure 19: New vs old measurements of stiffness.

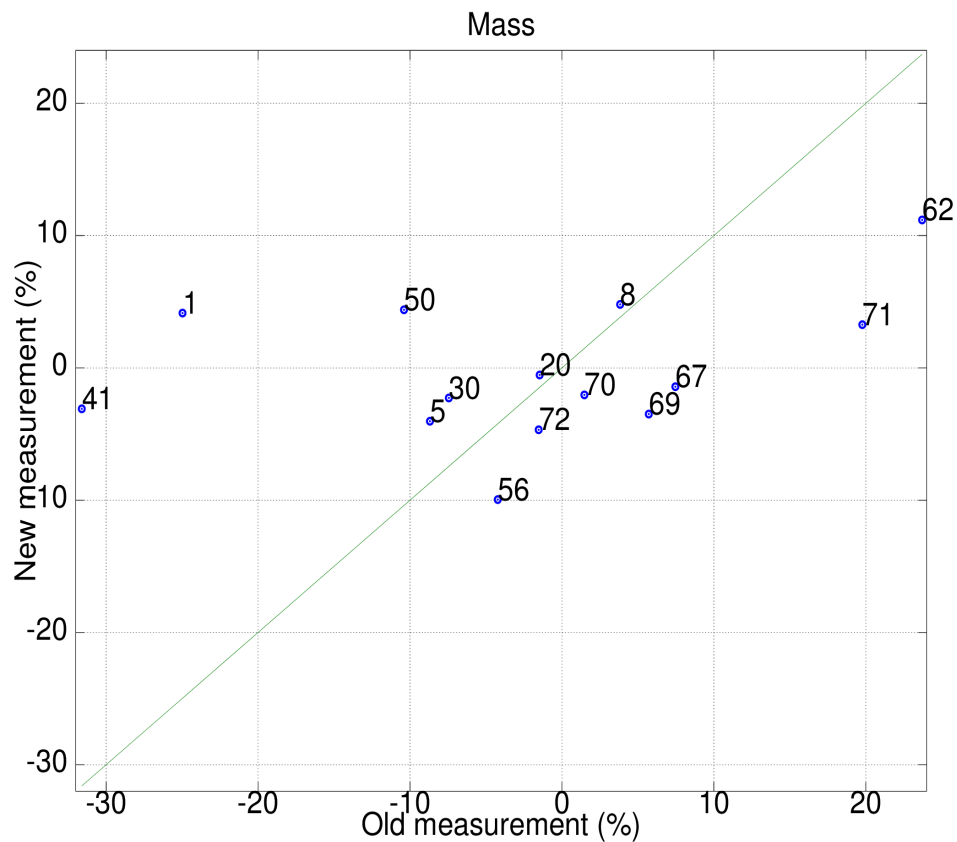

Figure 20: New vs old measurements of mass.

4.4 Discussion

“In vitro“ measurements made without the use of the artificial lip performed within short time period have great repeatability, which suggests that the measuring technique is robust and accurate enough. Comparing the results of “in vitro” measurements made over a time period of several months however shows that the dynamical parameters of the reeds are changing significantly with time. Results from measurements made with the artificial lip are much less repeatable.

5 Correlations between different approaches

In this section, the reeds of series 1 are used to compare the results of three different approaches (subjective, “in vivo” and “in vitro”).

At first, the linear correlation coefficients between all variables are computed. Results are shown in Table 1. They show that certain playing parameters (“in vivo”) have important correlation with the subjective indicators strength and brightness.

		Subjective indicators				Reed parameters		
		Strength	Brightness	Projection	Homogeneity	Relative stiffness (%)	Relative Quality factor (%)	Relative Mass (%)
Subjective indicators	Strength	1,00	-0,51	-0,21	0,14	0,62	-0,08	0,44
	Brightness	-0,51	1,00	0,83	0,44	-0,13	0,27	-0,11
	Projection	-0,21	0,83	1,00	0,74	-0,20	0,15	-0,24
	Homogeneity	0,14	0,44	0,74	1,00	-0,18	-0,22	-0,11
Playing parameters	MRAT	0,80	-0,32	-0,01	0,33	0,56	-0,01	0,26
	MRHSC	-0,47	0,79	0,62	0,05	-0,19	0,32	-0,24
	MROHSC	-0,49	0,75	0,59	0,02	-0,24	0,29	-0,27
	MREHSC	-0,44	0,80	0,62	0,07	-0,14	0,31	-0,18
	MROER	-0,31	0,20	0,23	-0,03	-0,37	-0,01	-0,28
	MRTR2	0,50	-0,56	-0,18	0,41	-0,08	-0,39	-0,05
	MRPTh	0,93	-0,55	-0,41	0,02	0,59	-0,23	0,59
	MRMP	0,90	-0,47	-0,38	0,03	0,69	-0,09	0,58
	MREff	-0,32	0,15	0,09	-0,38	-0,23	0,23	-0,30

Table 1: Correlation coefficients R between subjective descriptors, playing parameters (“*in vivo*”) and “*in vitro*” indicators (reed parameters). Note C3 is not taken into account for the calculation of the playing parameters. Color case show correlation coefficient greater that 0.6 or 0.7 or 0.8.

The higher value of correlation coefficients show a correlation between the strength and Relative Mean Threshold pressure (or Relative Mean Mouthpiece Pressure). Another lower correlation exists between the brightness and the Relative Mean Harmonic Spectral Centroid. This last result is in agreement with previous results which show that brightness is correlated with Harmonic Spectral Centroid ([15]).

Correlation coefficients between the reed indicators (“*in vitro*”) and other indicators show low correlation coefficients. The best correlation shows a relationship between the relative reed stiffness and the mean Mouth pressure. However this correlation coefficient remains very low compared to other ones.

The correlation between threshold pressure and subjective strength seems obvious from the musician's point of view but usual equations describing the functioning of single instruments show a direct relation between reed equivalent stiffness and threshold pressure, which does not appear in our results. This seems to show that the “*in vitro*” measurement bench using a low amplitude excitation does not provide with the relevant stiffness which is introduced in the equations. This measured reed stiffness is not able to explain the playing parameters and the subjective parameters.

5.1 Comparison of subjective parameters with playing parameters

To see how the subjective variables correlate with the objective variables, the four subjective variables are projected on the factorial plane as additional variables (Figure 21). We noticed that the brightness is correlated with the group of variables related to the spectral centroid. This confirms a result of the state of the art. The strength is correlated with variables related to the mouth pressure and threshold pressure and attack time, opposite to efficiency. This result makes sense. Projection and homogeneity are not well represented in the factorial plane, and it is not possible to visualize correlations.

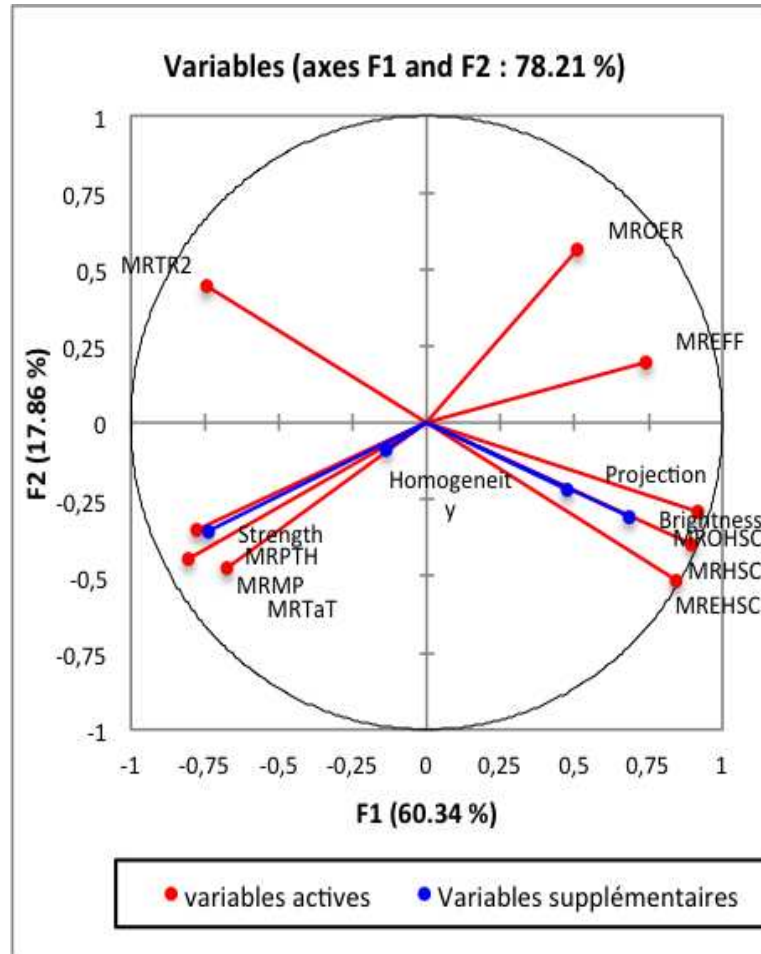

Figure 21: Principal Component Analysis of the “in vivo” measurements.

From these results, we selected two subjective descriptors, which correlate with objective variable: brightness and strength.

For each of these descriptors, linear regressions with the descriptor as the dependent variable and the objective criteria as the independent variables, are computed. An optimization of the model, according to the average squared error, was carried out (model with only one independent variable).

For the strength, the selected variable of the best model was the relative mean pressure threshold MRPTH (Figure 22). The R^2 for the regression is 0.87. For the brightness, the selected variable was the MREHS (Figure 23). The R^2 for the regression is 0.64.

Figure 23 shows that the correlation between the RMEHSC and the brightness is due to the two extreme reeds which enable to obtain strong variations. The good adjustment of the model on the data for the strength of the reed make us confident for the use of this model to predict the perceived strength of the reed.

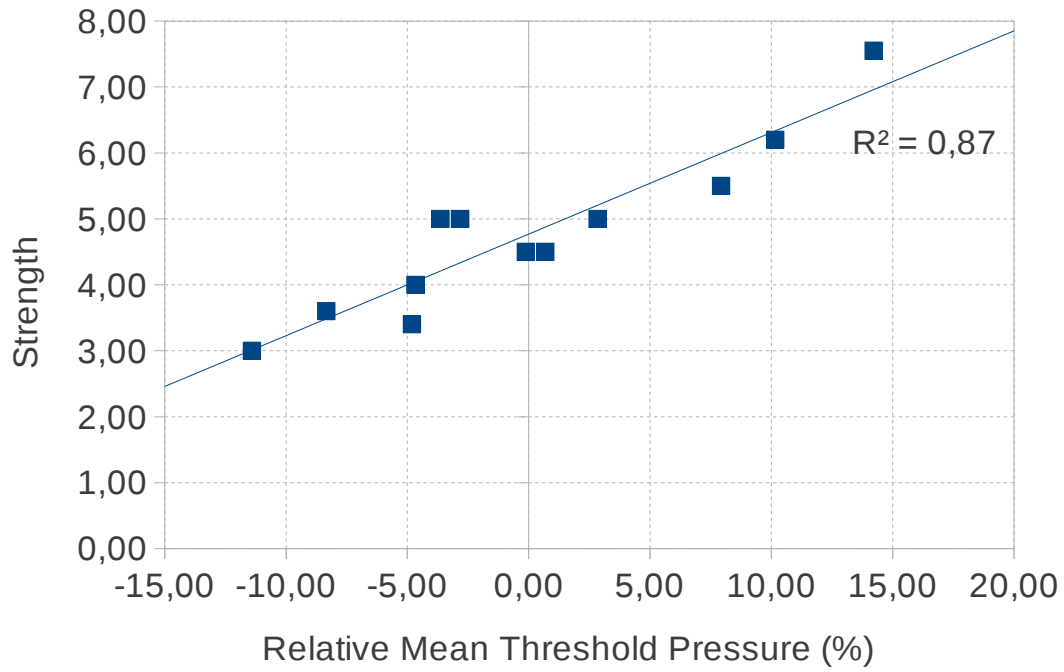

Figure 22: Strength plotted as a function of the relative mouth pressure threshold MRPTh calculated without note C3.

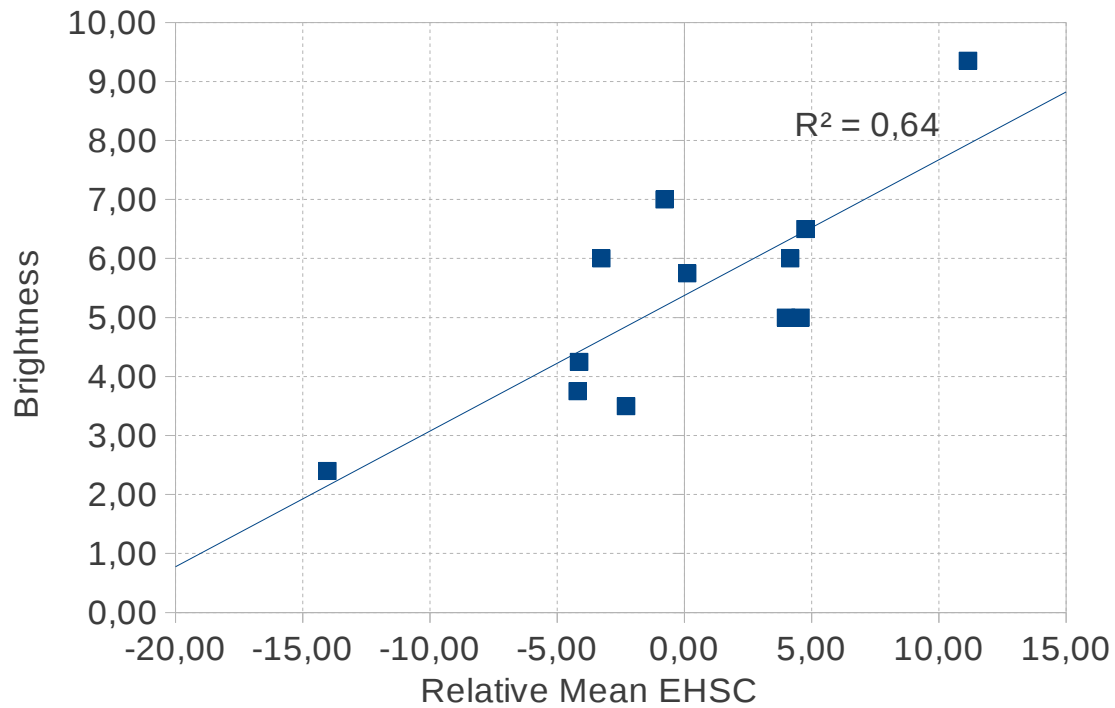

Figure 23 : brightness plotted as a function of the relative mean Even HSC calculated without note C3.

5.2 Comparison of reed parameters with playing parameters and subjective indicators

The ACP of “in vitro” parameters is presented in Figure 24 and shows that, for this reed series, the three “in vitro” indicators RQ RS RM constitute a 2d space. To see how the playing parameters (“in vivo” variables) correlate with the reed parameters (“in vitro variables), the “in vivo” variables are projected on the factorial plane as additional variables (Figure 24). These results show that there is not any strong correlation between the “in vitro” indicators and the playing parameters (“in vivo”). The highest correlation is between MRMP and RS.

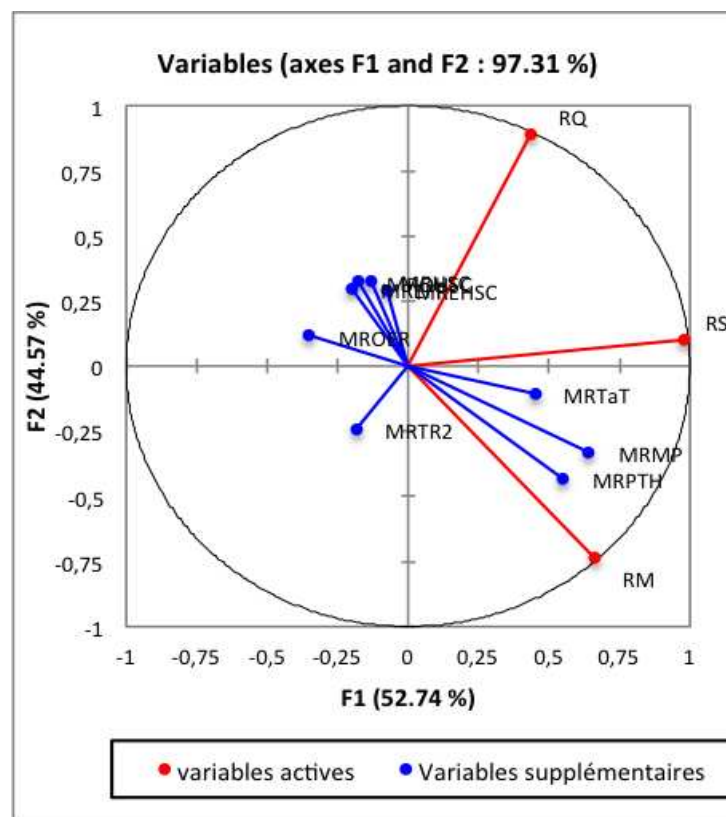

Figure 24: Principal Component Analysis of the “in vitro” measurements. RS is the relative stiffness, RQ is the relative Quality-factor and RM is the relative mass. “in vivo” variables are projected on the factorial plane.

Figure 25 Shows the linear regression between the relative stiffness and Relative Mean Mouth Pressure. The correlation remains very low, which shows that this “in vitro” measurement technique can not be used to predict the playing parameters with a linear model.

To see if the “in vitro” indicators can better explain the subjective indicators, subjective variables are projected on the factorial plane as additional variables (Figure 26). The indicator “strength” seems to be correlated with the relative stiffness (RS) and relative mass (RM). Figure 27 presents the strength as a function of the relative stiffness and shows that the “in vitro” measurement technique used in this work can not explain the subjective indicators with a linear model.

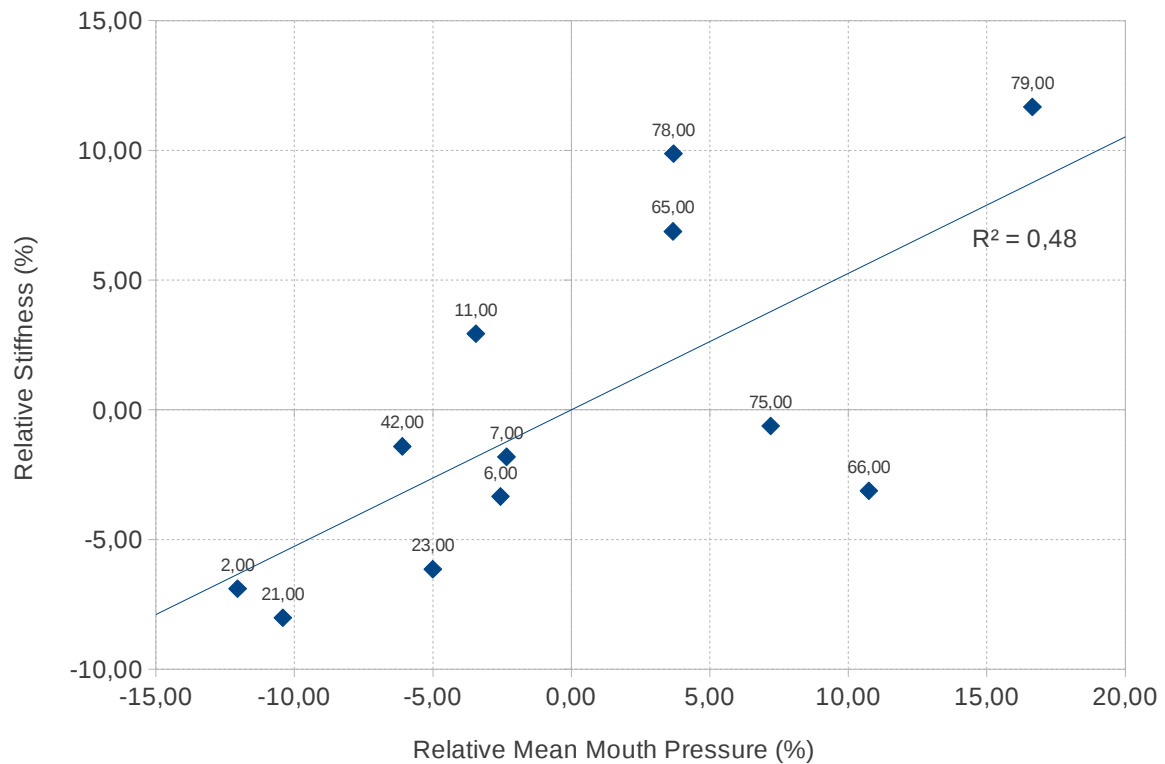

Figure 25: relative Mean Mouth Pressure as a function of the relative stiffness measured “in vitro”. The linear correlation coefficient R^2 is much lower than this found in

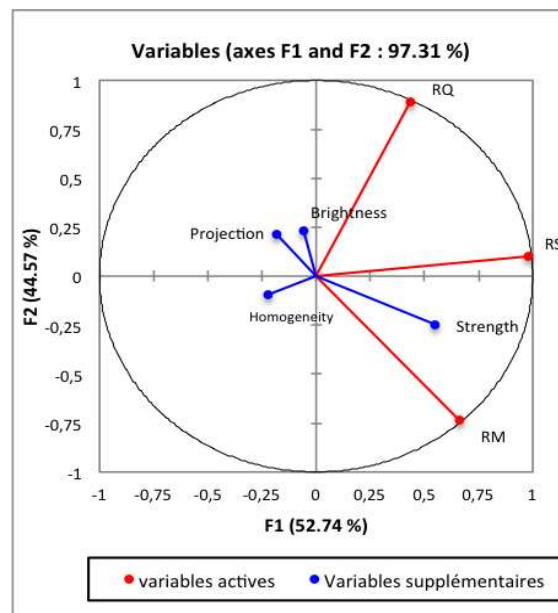

Figure 26: Principal Component Analysis of the “in vitro” measurements. RS is the relative stiffness, RQ is the relative Quality-factor and RM is the relative mass. Subjective descriptors are projected on the factorial plane as additional variables.

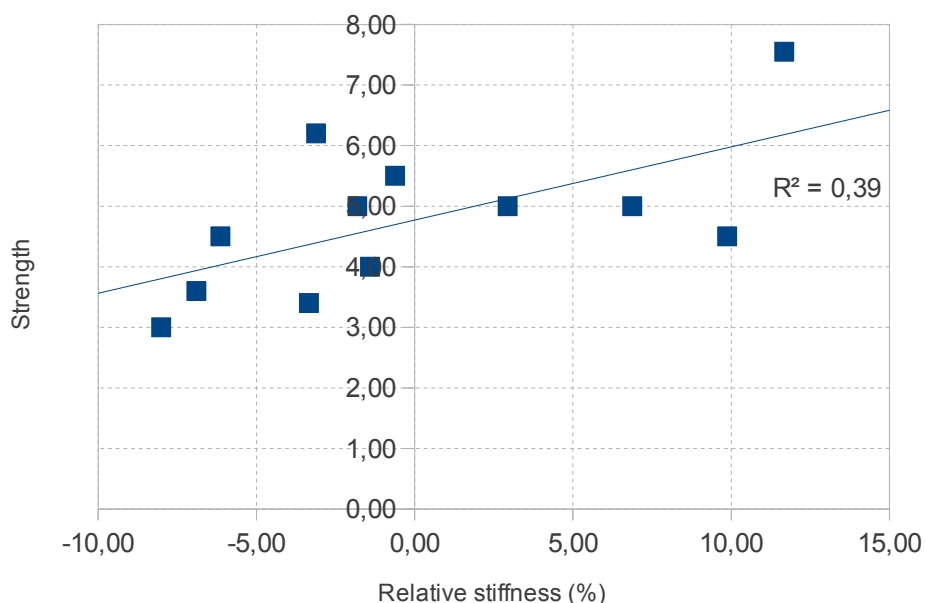

Figure 27: subjective strength as a function of the relative stiffness.

6 Conclusion

This work presents three approaches for characterizing two series of saxophone reeds. First approach uses subjective tests. The experiment performed using series 1 (12 reeds) and one musician shows that the reed quality can be represented by two main dimensions which account for 90% of variance. First dimension is mainly created by the descriptors brightness, projection and homogeneity, which are correlated and second dimension is created by the descriptor strength. The second approach uses the "in vivo" characterization and estimates different playing parameters (threshold pressure, spectral centroid, ...) from pressure signals measurements (mouth pressure, bell acoustic pressure). The comparison between the subjective dimensions and the "in vivo" parameters shows that the estimated threshold pressure is correlated with the subjective dimension "strength" with a determination coefficient equal to 0.87. This result makes us confident for the use of the in vivo measurements as predictors of the subjective quality of reeds. Further studies will be carried out to establish predictive models and test their predictive qualities.

Finally, reeds are characterized using a vibroacoustics bench, with or without the use of an artificial lip. The dynamic "reed parameters" (stiffness, quality factor, mass) are extracted from the vibroacoustical response, obtained with a low level (100 dB) acoustical excitation signal, leading to small displacement of the reed tip (a few μm). Analysis of series 2 of reed (14 reeds) shows that the "in vitro" measurement has a good repeatability for short-term measurements without artificial lip. Short-term measurements with artificial lip and long-term measurements without artificial lip show great variance in the estimated parameters. The reed parameters obtained with series 1 do not show any strong correlation neither with the "in vivo" parameters nor with the subjective descriptors. These results show that the method used for estimating the reed parameters is not robust enough. Different non-controlled factors (humidity, position, ...) may have a strong influence on the measurements of the frequency response of the reeds. Furthermore, the absence of significant correlations between the in vitro parameters and the subjective descriptors shows that the prediction of the subjective quality with in vitro measurements made in the described form is not possible with a linear model. Further studies should be necessary to improve the experimental method for the measurement of the response of the reeds.

References

- [1] P. Kolesik, A. Mills, and M. Sedgley. Anatomical characteristics affecting the musical performance of clarinet reeds made from *arundo donax* L. (gramineae). *Annals of Botany*, 81(1):151–155, 1998.
- [2] S.C. Mukhopadhyay, G.S. Gupta, J.D. Woolley, and S.N. Demidenko. Saxophone reed inspection employing planar electromagnetic sensors. *Instrumentation and Measurement, IEEE Transactions on*, 56(6):2492–2503, 2007.
- [3] E. Obataya and M. Norimoto. Acoustic properties of a reed (*arundo donax* L.) used for the vibrating plate of a clarinet. *The Journal of the Acoustical Society of America*, 106:1106, 1999.
- [4] F. Pinard, B. Laine, and H. Vach. Musical quality assessment of clarinet reeds using optical holography. *The Journal of the Acoustical Society of America*, 113:1736, 2003.
- [5] P. Picart, J. Leval, F. Piquet, JP Boileau, T. Guimezanes, and JP Dalmont. Study of the mechanical behaviour of a clarinet reed under forced and auto-oscillations with digital fresnel holography. *Strain*, 46(1):89–100, 2010.
- [6] Pierre-André Taillard, Franck Laloë, Michel Gross, Jean-Pierre Dalmont, and Jean Kergomard. Measurements of resonance frequencies of clarinet reeds and simulations, arXiv preprint arXiv:1202.2114, 2012.
- [7] M. Barthet, P. Guillemain, R. Kronland-Martinet, and S. Ystad. From clarinet control to timbre perception. *Acta Acustica United with Acustica*, 96(4):678–689, 2010.
- [8] J. W. Beauchamp. Synthesis by spectral amplitude and brightness matching of analyzed musical instrument tones. *J. Audio Eng. Soc.*, 1982.
- [9] G. Peeters. A large set of audio features for sound description (similarity and description) in the *cuidado* project. Technical report, I.R.C.A.M., 2004.
- [10] Bruno Gazengel and Jean-Pierre Dalmont. Mechanical response characterization of saxophone reeds. In *Proceedings of "Forum Acusticum"*, page 000124, Aalborg, Denmark, June 2011.
- [11] M.L. Facchinetti, X. Boutillon, and Constantinescu X. Numerical and experimental modal analysis of the reed and pipe of a clarinet. *The Journal of the Acoustical Society of America*, 2003.
- [12] B. Gazengel, T. Guimezanes, J.P. Dalmont, J.B. Doc, S. Fagart, and Y. Léveillé. Experimental investigation of the influence of the mechanical characteristics of the lip on the vibrations of the single reed. In *Proceedings of the International Symposium on Musical Acoustics*, Barcelona, Spain, 2007.
- [13] Fabrice Silva, Didier Ferrand, and Christophe Vergez. Seuils d'oscillation d'un instrument de musique à anche simple : protocole expérimental & instrumentation d'une bouche artificielle. In *Actes du XIXème Congrès Français de Mécanique*, pages CD-ROM (6 pages), Marseille, France, 2009. OR 21 OR 21.
- [14] J. Piranda. Analyse modale expérimentale. *Technique de l'ingénieur*, 6180:199, 2001.
- [15] Poirson, E. and Petiot, J.F. and Gilbert, J., Study of the brightness of trumpet tones, *The Journal of the Acoustical Society of America*, 118, 2656, 2005