



HAL
open science

Reliability Estimation from Test Data Using Two Different Approaches

J. Hersant, S. Cloupet, Fabien Guérin, Luc Chevalier

► **To cite this version:**

J. Hersant, S. Cloupet, Fabien Guérin, Luc Chevalier. Reliability Estimation from Test Data Using Two Different Approaches. 2012 Annual Reliability and Maintainability Symposium (RAMS), Jan 2012, France. p.1. hal-00782379

HAL Id: hal-00782379

<https://hal.science/hal-00782379>

Submitted on 29 Jan 2013

HAL is a multi-disciplinary open access archive for the deposit and dissemination of scientific research documents, whether they are published or not. The documents may come from teaching and research institutions in France or abroad, or from public or private research centers.

L'archive ouverte pluridisciplinaire **HAL**, est destinée au dépôt et à la diffusion de documents scientifiques de niveau recherche, publiés ou non, émanant des établissements d'enseignement et de recherche français ou étrangers, des laboratoires publics ou privés.

Reliability Estimation from Test Data Using Two Different Approaches

J. Hersant, LASQUO-ISTIA

S. Cloupet, LASQUO-ISTIA

F. Guérin, LASQUO-ISTIA

L. Chevalier, LMSM, UMR8208 CNRS, Univ Paris Est

Key Words: Reliability, Degradation, Stochastic Process, Wear, Fatigue

SUMMARY

This paper compares two different approaches to estimate the reliability of mechanical components subject to degradation (wear, fatigue, etc.). This estimate is realized by considering the degradation drift (periodic or continuous measurement of the degradation level) from tests or exploitation. Two approaches are presented in this article. The first approach is based on a deterministic mechanical model given by the study of physical facts coupled with a Monte Carlo simulation to propagate the uncertainties of input parameters on the degradation. The second approach, based on the stochastic process, uses the Wiener process to model the evolution of degradation over time. A nonlinear formulation is developed in this paper. We compare these two approaches on an industrial case: the wear in rolling contact. The drift of degradation is estimated by the two approaches. We then calculate the failure distribution and associated reliability. Analysis of the results obtained with both approaches is made to discuss the advantages and disadvantages of each.

1 INTRODUCTION

This paper proposes to compare two different approaches found in literature to estimate the reliability of a mechanical component from measurements of degradation. A deterministic mechanical model given by the study of physical facts coupled with a probabilistic method on the input parameters to propagate the uncertainties on the degradation is compared to a stochastic approach, based on the stochastic process. Many processes can be used to model degradation due to wear: Gamma, Wiener, Markovian [1], [2] and [3]. However, in this paper, we use only the Wiener process with a nonlinear formulation. The main difference concerns the inclusion of uncertainties in the degradation. Consider a degradation described by a physical model:

$$y(t) = f(t; \theta) :$$

- $y(t)$ represents the degradation level at time t
- t represents time
- $f(t; \theta)$ represents the function describing the dynamics of degradation
- θ represents the vector of functions parameters

In the Reliability analysis based on mechanical engineering approach, stochastic effect is contained in the variability of vector θ , while stochastic processes integrated it independently.

In a first part, we present the 2 different approaches. In a second part, we apply these approaches to wear in steel rolling contacts from test results which are available in [4]. Finally, we discuss the results.

2 MODELING STOCHASTIC PROCESSES

2.1 Approach 1: Reliability based on mechanical engineering Modeling

This first approach consists to perform simulations with different sets of parameters. They can be stochastic or deterministic. The dispersion of each parameter is represented by a probability density known from tests. A Monte-Carlo simulation is performed for each parameter and a set is created. A simulation from the deterministic model is then performed with this set of parameters.

In this case, the function describing degradation dynamic is given by the study of physical facts of these degradation phenomena. Mostly, this model describes the average behavior and random aspects are introduced by the model parameters. Thus, each parameter $\theta = \{\theta_1, \theta_2, \dots, \theta_m\}$ is defined by a statistical law as in Figure 1.

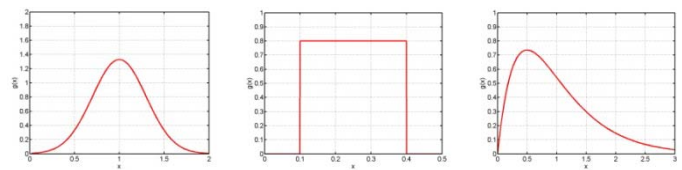

Figure 1 - probabilistic distributions of model parameters

These statistical laws are determined by an analysis of tests results. It could be directly on the degradation phenomena with maximum likelihood (case (a), Figure 2) or during independent tests as the coefficient of friction (case (b), Figure 2).

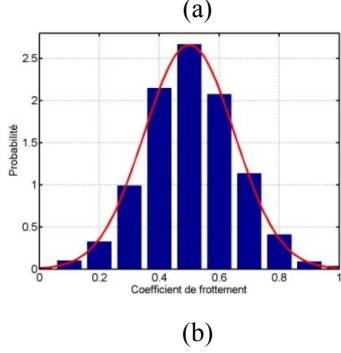
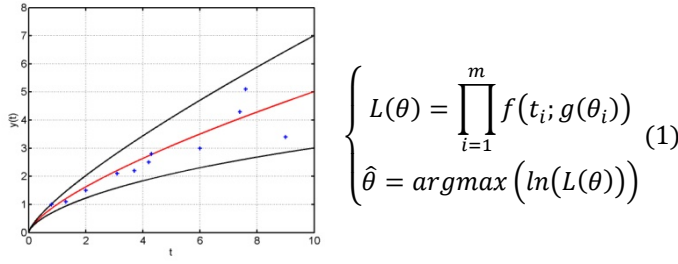

Figure 2 - Determination of distributions from tests results, (a) by maximum likelihood, (b) directly from measurements in independent tests

Then we use Monte-Carlo method to define reliability. This method consists to randomly draw values of random parameters θ_i to build the degradation model $y(t)$ and repeat this procedure n times. Finally, we have a curve network modeling the variability of the degradation process (Figure 3).

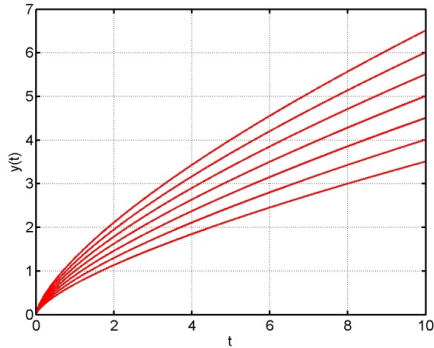

Figure 3 - Curve network obtained by Monte-Carlo simulation

2.2 Approach 2 : Modeling stochastic processes

Degradation processes are derived from trajectories of stochastic processes with independent increments [5]. The Wiener process [1] characterizes increasing degradation on average but it is possible that the degradation decreases between two consecutive moments.

2.2.1 Wiener process with linear trend

To illustrate this approach, we consider a Wiener process $y(t)$ with mean m and variance σ^2 . A Wiener process, in the case of linear trend, has the following properties:

- The initial degradation is zero : $y(0) = 0$

- $\{y(t), t > 0\}$ is a process with stationary and independent events
- $\forall h > 0$ and $\forall t > 0$, increments $(y(t+h) - y(t))$ have a normal distribution $N(mh, \sigma^2 h)$ with probability density function:

$$\forall t > 0, f(y) = \frac{1}{\sigma\sqrt{2\pi h}} e^{\left(\frac{-(y-mh)^2}{2\sigma^2 h}\right)} \quad (2)$$

The time to failure distribution follows an inverse Gaussian distribution $IG(y_0/m, y_0/\sigma^2)$ and its probability density function is defined by:

$$f(T; y_0, m, \sigma) = \frac{y_0}{\sigma\sqrt{2\pi}} T^{-\frac{3}{2}} e^{\left(\frac{-(y_0-mT)^2}{2\sigma^2 T}\right)} \quad (3)$$

To estimate the mean and the standard deviation of this process, we use the maximum likelihood method from the observed increments in tests. We note the increments of degradation ΔZ_{ij} (i is the trajectory and j the time).

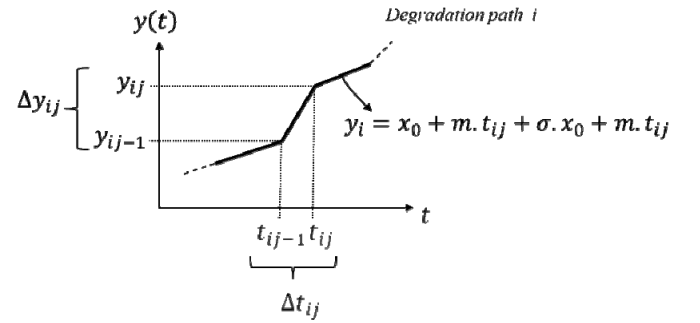

Figure 4 - Definition of increment of degradation

Δy_{ij} is characterized by a normal distribution with mean $m\Delta t_{ij}$ and variance $\sigma^2\Delta t_{ij}$, so the likelihood is written:

$$L(m, \sigma^2) = \prod_{i=1}^n \prod_{j=1}^m \frac{1}{\sigma\sqrt{2\pi\Delta t_{ij}}} e^{\left(\frac{(\Delta y_{ij} - m\Delta t_{ij})^2}{2\sigma^2\Delta t_{ij}}\right)} \quad (4)$$

2.2.2 Wiener process with non-linear trend

Now consider a Wiener process $y(t)$ with non-linear trend. It has the following properties:

- The initial degradation is zero : $y(0) = 0$
- $\{y(t), t > 0\}$ is a process with stationary and independent events
- $\forall h > 0$ and $\forall t > 0$, increments $(y(t+h) - y(t))$ have a normal distribution $N(m(t+h) - m(t), \sigma^2 h)$ with probability density function :

$$\forall t > 0, f(y) = \frac{1}{\sigma\sqrt{2\pi h}} e^{\left(\frac{-(y-(m(t+h)-m(t)))^2}{2\sigma^2 h}\right)} \quad (5)$$

There is no expression for the time to failure distribution. It is necessary to perform numerical method to estimate this distribution.

The parameters estimation is performed by the maximum of likelihood method which is written:

$$L(m(t), \sigma^2) = \prod_{i=1}^n \prod_{j=1}^m \frac{1}{\sigma\sqrt{2\pi\Delta t_{ij}}} e^{\left(\frac{(\Delta Z_{ij} - (m(t_{i,j+1}) - m(t_{i,j})))^2}{2\sigma^2\Delta t_{ij}}\right)} \quad (6)$$

3 WEAR PHENOMENA

We propose in this paper to apply these two approaches to the wear phenomena. The wear by removing the steel on steel rolling contact. These degradation phenomena have been studied and described in [6]. The degradation could follow non-linear and/or linear curves.

Many authors were interested in solving this problem and some of them are based on empirical modeling of wear produced by Archard [7]:

$$W = K \frac{F}{H} l \quad (7)$$

W is the volume of wear, K is a non-dimensional coefficient of wear that characterized a couple of materials, F is the contact force, H is the material hardness and l the sliding length. In cyclic contacts, from the Archard expression, we can write the accumulation of wear based on successive passes. In [9], it is provided a local writing Archard model.

To compare the two approaches, we have test results in [4]. These tests consisted of rolling rollers loaded onto a cylinder (acting cam). The input parameters are deterministic, known and controlled, or probabilistic because it was difficult to control certain parameters. Figure 5 summarizes this state.

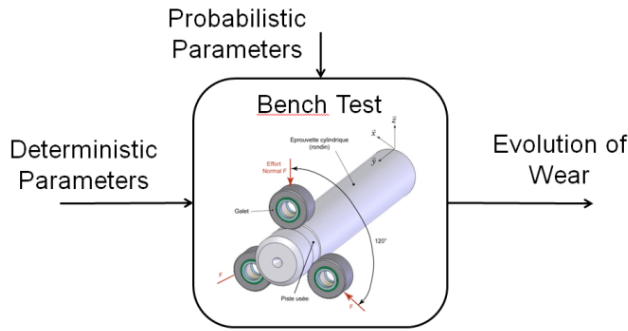

Figure 5 : Different input parameters of the test bench.

The tests results are shown in Figure 6:

Test 1		Test 2		Test 3	
t1 (min)	y1 (μm)	t2 (min)	y2 (μm)	t3 (min)	y3 (μm)
0	0	0	0	0	0
18	5	77	23,4	25	5
27	9,7	122	45,9	80	18,9
99	10,9	277	52,55	107	23
256	24	317	45,9	324	54,8
362	21,9	372	45,9	381	61,6
397	31	432	51,3	438	73
		477	62,5	533	69,4
				704	73,2
				822	87,2
				859	100,5
				959	100,9
				1017	109,35

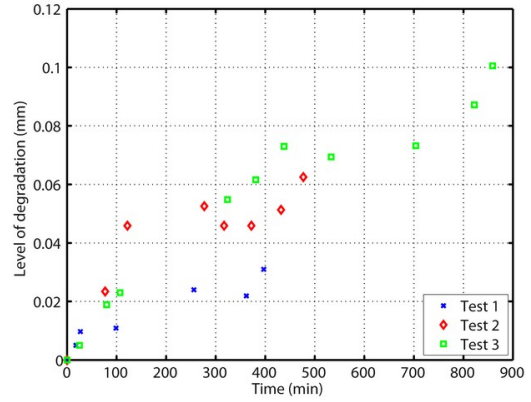

Figure 6 : 3 experimental results

We can see in Figure 6, between two successive points, it can have a decreasing of wear. Physically, this would correspond to an addition of material over time, which is not true here. This reflects the fact that there are measurement errors that must be taken into account in modeling. Only the approach 2 makes it possible because the approach 1 is strictly increasing.

To compare these three tests, simulations are cut to 440 minutes.

4 STOCHASTIC MODELLING OF WEAR

In this section we simulate degradation paths due to wear with the two approaches presented in section 2. We compare these models with experimental results.

4.1 Structural Reliability Approach

In rolling contact, surface wear is due to repeated passage of a component on another. It is therefore important to take the mechanical quantities at interface: contact pressure, tangential stress due to friction between two solids, the material parameters, etc ... We place ourselves in case where the steel materials in contact have elastic deformation and wear which is generated by removal of material. We do not present modeling in this article that is widely described in the work of [4], [8], [10-11] that use [12-14].

The resolution of the problem is therefore as follows:

1. Definition of initial profiles of the cam and the roller before wear.
2. Selectable number of cycles that are to be achieved (number of passes of the roller).
3. Calculation of pressure field, the stress field and the sliding velocity at the contact. Due to the large number of simulations, quick calculation methods have been set up.
4. Calculation of the dissipated power at the contact [4] and [6] and wear with updating profiles after degradation
5. We repeat steps 3 and 4 to reach our stopping criterion: the generated wear.

This calculation method is used for each set of parameters from a draw. There are 5 probabilistic parameters:

1. The contact force F
2. The friction coefficient μ
3. The slip v_x

4. The longitudinal creep v_x and the spin φ_x .
The probability density functions of each parameter are shown Figure 9.

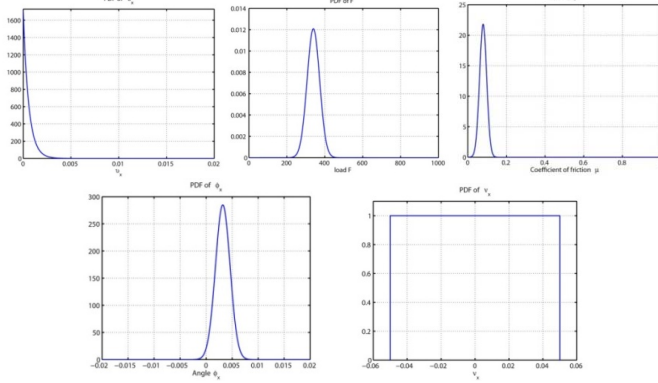

Figure 7 - probabilistic density function (pdf) calculated for each of five probabilistic parameters.

We present in Figure 8, the 2100 simulations with the experimental points.

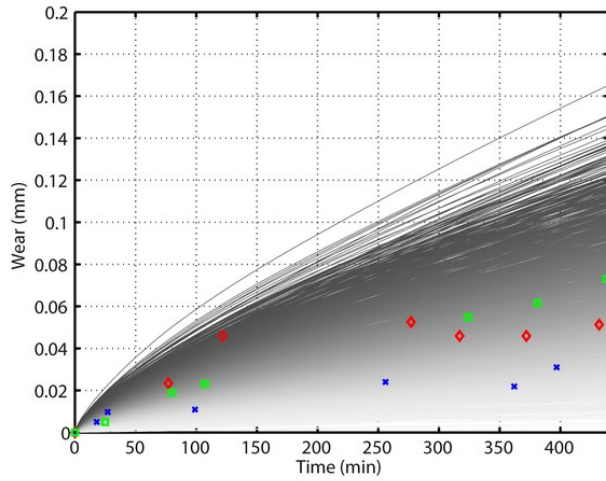

Figure 8 - Calculation of 2100 simulations from the approach 1.

4.1.1 Evolution of the mean in time with the Structural Reliability Approach

In this section, we present the evolution of the mean of wear in time following Monte-Carlo method. It is obtained by calculating the average value of simulations for each time such as:

$$\bar{y}(t) = \bar{f}(t; \theta) \quad (8)$$

Figure 9 shows the evolution of the mean.

4.1.2 Evolution of the standard deviation in time with the Structural Reliability Approach

Figure 11 shows the evolution of the standard deviation in time from Monte-Carlo method by counting the paths:

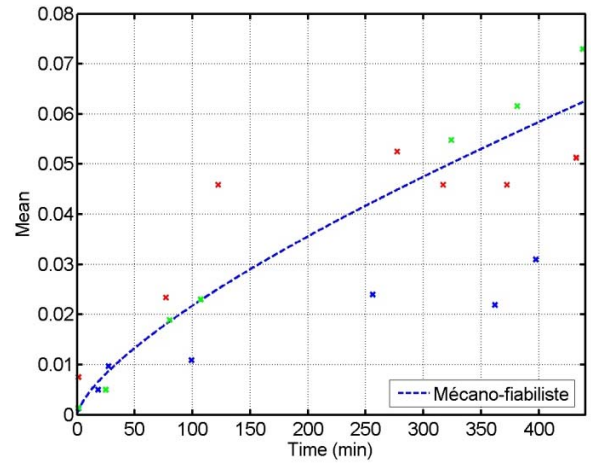

Figure 9 - Evolution of the mean

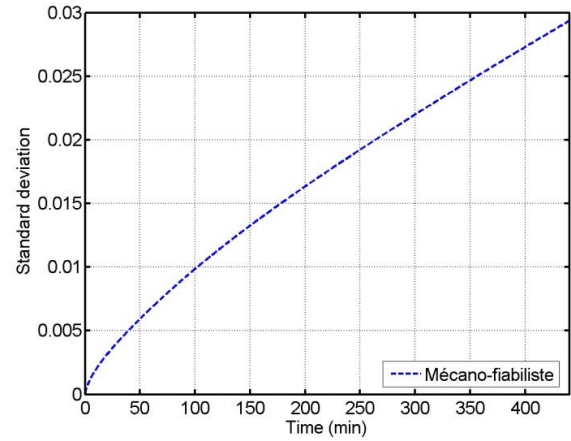

Figure 100 - Implementation of the standard deviation

4.1.3 Construction of the confidence interval.

In this section, we built only confidence intervals at 90% confidence. With the Monte Carlo approach, we use a nonparametric method (percentile 5% and 95%). In practice, this corresponds to remove:

- The 105 simulations in which wear is lowest
- The 105 simulations in which wear is highest

This methodology is applicable because the curves don't intersect.

Figure 11 we present the confidence interval and the average associate.

4.2 Modeling of the Wiener process with non-linear trend

We simulate 1000 degradation paths according to a Wiener process with non-linear trend whose parameters are calculated from test data presented in Figure 6.

We assume that the mechanical model follows a power law form:

$$y(t) = a \times t^\alpha \quad (9)$$

A regression model is calculated on each test and presented Figure 12:

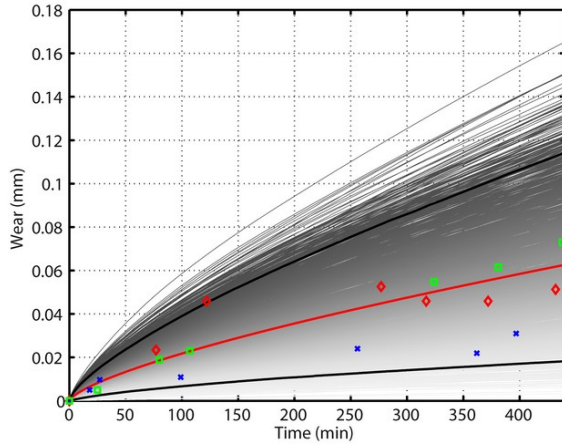

Figure 11 : Construction of the confidence interval for counting.

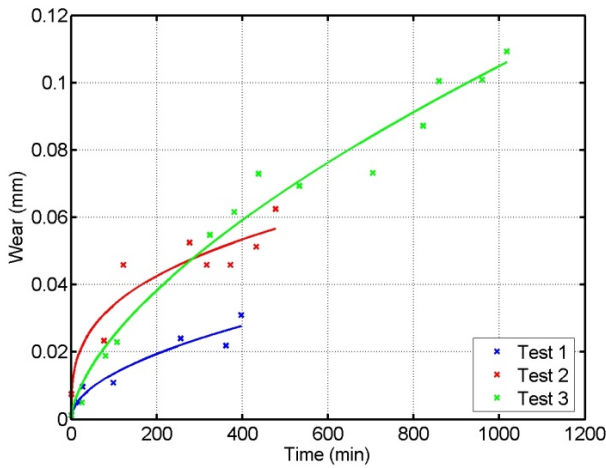

Figure 12 - Installation of a power law on test data

For all three regression models, we find the following correlation coefficients:

	a	α	R^2
Test 1	1.3152	0.5067	0.9695
Test 2	7.3447	0.3291	0.9459
Test 3	1.05	0.6656	0.9763

Figure 13 - Correlation coefficients of power law models

The R^2 coefficient is high for the three tests, so the hypothesis of power law is accepted.

4.2.1 Determination of parameters of the power law from the test data

To determine the parameters of the power law from the test data, we use the maximum likelihood method. The likelihood is written:

$$L(a, \alpha, \sigma^2) = \prod_{i=1}^n \prod_{j=1}^m \frac{1}{\sigma \sqrt{2\pi \Delta t_{ij}}} e^{-\left(\frac{(\Delta Z_{ij} - a \times (t_{ij+1}^\alpha - t_{ij}^\alpha))^2}{2\sigma^2 \Delta t_{ij}} \right)} \quad (10)$$

By applying the maximum likelihood, we obtain the following results:

a	α	σ
6.770×10^{-4}	7.111×10^{-1}	9.787×10^{-4}

Figure 14 - Coefficients of the Wiener process with non-linear trend from tests

Then we trace the evolution of the mean and the standard deviation of the process in time by analyzing the levels of degradation paths. We overlay the analytically determined evolution.

4.2.2 Evolution of the mean and the standard deviation in time following a Wiener process with non-linear trend

We check that the evolutions in the mean and the standard deviation obtained by simulation are identical to those obtained analytically. Figures 15 and 16 show a superposition.

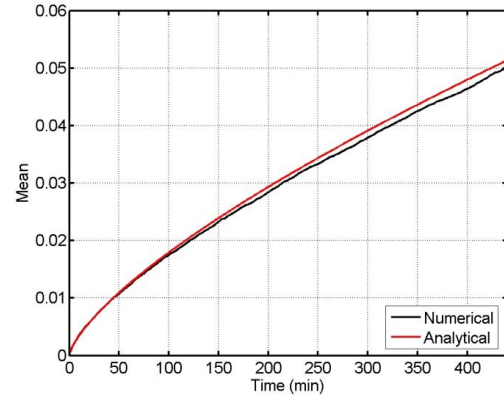

Figure 15 - Mean versus time

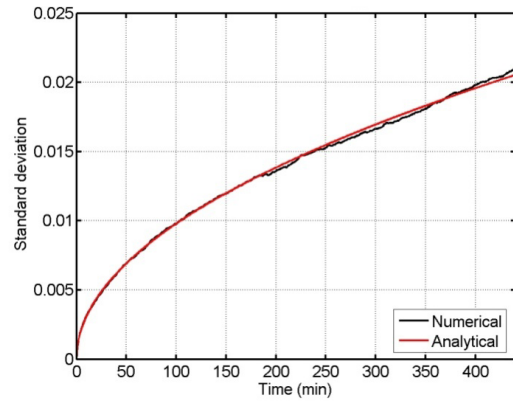

Figure 16 - Standard deviation versus time

In Part 5, for comparison, the approach 2 is presented from the results obtained analytically.

4.2.3 Determination of confidence intervals

We determine the 90% confidence intervals for the approach 2.

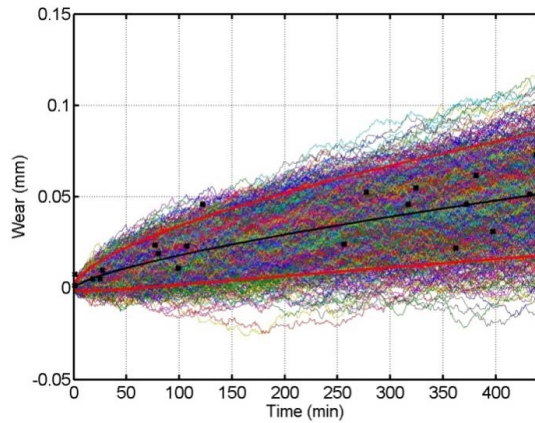

Figure 17 - 90% confidence intervals for the approach 2.

5 COMPARISON OF RESULTS

Figure 18 and Figure 19 respectively present comparisons of evolutions in means and standard deviations obtained with the two approaches.

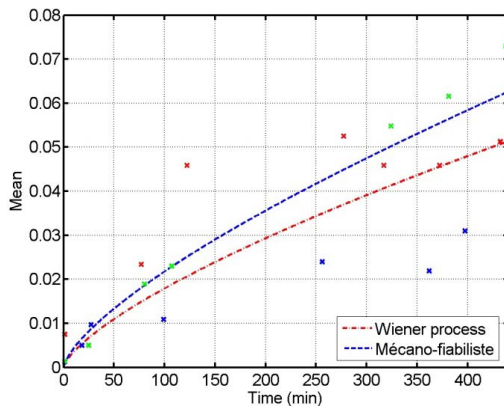

Figure 18 - Means versus time

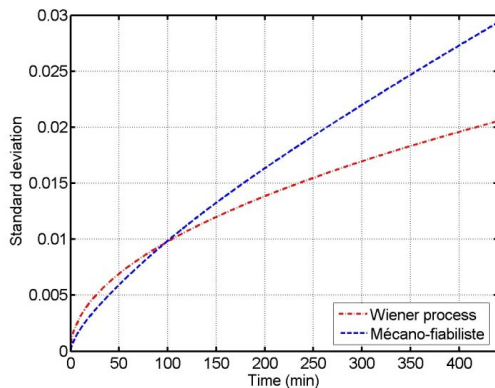

Figure 19 - Standard deviations versus time

We observe that the means and standard deviations of the Structural Reliability Approach analysis increase the mean and standard deviation of the "stochastic" approach by the Wiener process with non-linear trend. In the case of the mean, we explain this discrepancy by greater levels of wear obtained with approach 1. It is explained by the fact that the approach 1

is not a result of the analysis of test data, while approach 2 is. Also, by comparing Figure 11 with Figure 17, the 90% confidence interval is larger with the approach 1 than with the approach 2 which is consistent with an increase in the standard deviation with approach 1.

6 TEST BENCH

The objective is to achieve a bench test to perform tests of wear in rolling contact. It is in progress with ARTS ET METIERS PARISTECH. Figure 21 shows a CAD view of the bench:

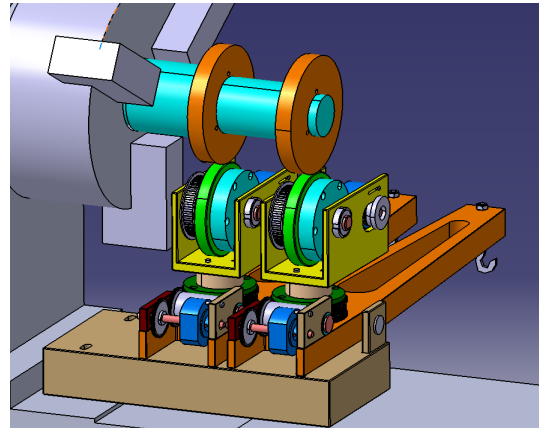

Figure 20 - Bench test.

We bring together a spherical metallic component (roller) on a cylindrical metal component (log). We control the rotational speed of the log, the contact force and angle of rotation of the roller. We measure the rotational speeds of the log and rollers and efforts the following three dimensions.

For reasons of tests time, two independent systems are built in parallel.

CONCLUSION

In this paper, we presented two approaches for estimating the reliability of a component from measurements of damage. We then described the degradation phenomenon under study. We applied both approaches to wear in rolling steel on steel contacts in order to compare their results in a final part.

The means and standard deviations of the Structural Reliability Approach analysis increase the mean and standard deviation of the "stochastic" approach by the Wiener process with non-linear trend. It is explained by the fact that the approach 1 is not a result of the test data, while Approach 2 is.

To check the accuracy of each method should therefore put in place a series of tests highlighting this type of wear damage by removing material in order to compare and conclude through a test. A test bench is in progress with ARTS ET METIERS PARISTECH to perform these tests.

REFERENCES

1. M. Nikulin, L. Gerville-Réache et V. Couallier, Statistique des essais accélérés. Ed Hermes Science, pp. 229-258, Paris, 2007

2. V. Couallier, *Degradation modelling and semiparametric estimation with non independent noises*, Qualita, Bordeaux, 2005.
3. F. Guérin, M. Barreau, F. Coadou, R. Idrissi, Estimation de la fiabilité par des essais de dégradation, QUALITA 2009 (Mar), pp 18–20.
4. S.Cloupet, "Simulation de l'usure superficielle par microglissement dans les contacts roulants came-galet : approche probabiliste des dispersions expérimentales", thèse de Doctorat, ENS de Cachan, 2006.
5. A. J. Lemoine et M. L. Wenocur, *On Failure Modeling*. Naval Research Logistics Quarterly, vo. 32, Numéro 3, pp 497 - 508, 1985.
6. S. Cloupet, L. Chevalier, H. Chollet, Simulation probabiliste de l'usure dans les contacts roulants sous charges Probabilistic simulation of wear in loaded rolling contact, *Mécanique & Industries* 8 6 (2007) 609-630.
7. J.F. Archard, "Contact and rubbing of flat surfaces", *J. Appl. Phys.* vol. 24 pp. 981-988. 1953.
8. L. Chevalier, S. Cloupet, A. Eddhahak "Contributions à la modélisation simplifiée de la mécanique des contacts roulants", *Mécanique & Industries*. Vol 7. Num 2 (2006) 155-168
9. L. Chevalier, S. Cloupet, M. Quillien, "Friction and Wear during Twin-disc experiments under ambient and cryogenic conditions". *Tribology International*, vol. 39, 2006, pp. 1376–1387
10. J.B. Ayasse, H. Chollet, J.S. Fleuret, E. Leveque, CAF, *A generalised conicity criteria for the wheel rail contact. Example of a switch blade safety study*. 8th VSDIA Symposium, November, Budapest, Hungary. 2002.
11. L. Chevalier, S. Cloupet, A. Eddhahak, "On a Simplified Model for Numerical Simulation of Wear during Dry Rolling Contacts" *Journal of Tribology*
12. J.J. Kalker, A Fast Algorithm for the Simplified Theory of Rolling Contact, *Vehicle Syst. Dyn.* Vol. 11 pp. 1-13, 1982.
13. J.J. Kalker, *Wheel/rail wear calculations with the program CONTACT*, Contact Mechanics and Wear of Rail/Wheel System, Vol.2 pp. 3-26, 1987.
14. W. Kik, J. Piotrowski, *A fast approximative method to calculate normal load at contact between wheel and rail, and creep forces during rolling*, Warsaw Technical University, 2nd mini-conference on contact mechanics and wear of rail/wheel systems, Budapest, 1996.

BIOGRAPHIES

J. Hersant, S. Cloupet, F. Guérin
 LASQUO-ISTIA,
 62 rue Notre Dame du Lac,
 49000 Angers

e-mail: julien.hersant@univ-angers.fr

S. Cloupet
 LASQUO-ISTIA,
 62 rue Notre Dame du Lac,
 49000 Angers

e-mail: sylvain.cloupet@univ-angers.fr

F. Guérin
 LASQUO-ISTIA,
 62 rue Notre Dame du Lac,
 49000 Angers

e-mail: fabrice.guerin@univ-angers.fr

G. Germain
 LAMPA-ARTS ET METIERS PARISTECH
 2, boulevard du Ronceray, BP 93525
 49035 Angers Cedex 01

e-mail: guenael.germain@angers.ensam.fr

L. Chevalier
 LMSM, UMR8208 CNRS
 Univ Paris Est, 5 boulevard Descartes
 Champs sur Marne
 77454 Marne La Vallée cedex 2

e-mail: luc.chevalier@univ-paris-est.fr