



HAL
open science

Development of acoustic devices functionalized with cobalt corroles or metalloporphyrines for the detection of carbon monoxide at low concentration

M. Vanotti, V. Blondeau-Patissier, D. Rabus, J.-Y. Rauch, J.-M. Barbe, S. Ballandras

► To cite this version:

M. Vanotti, V. Blondeau-Patissier, D. Rabus, J.-Y. Rauch, J.-M. Barbe, et al.. Development of acoustic devices functionalized with cobalt corroles or metalloporphyrines for the detection of carbon monoxide at low concentration. *Sensors & Transducers.*, 2012, Physical and Chemical Sensors & Wireless Sensor Networks, 14 (1), pp.197-211. hal-00780315

HAL Id: hal-00780315

<https://hal.science/hal-00780315v1>

Submitted on 13 May 2021

HAL is a multi-disciplinary open access archive for the deposit and dissemination of scientific research documents, whether they are published or not. The documents may come from teaching and research institutions in France or abroad, or from public or private research centers.

L'archive ouverte pluridisciplinaire **HAL**, est destinée au dépôt et à la diffusion de documents scientifiques de niveau recherche, publiés ou non, émanant des établissements d'enseignement et de recherche français ou étrangers, des laboratoires publics ou privés.



Distributed under a Creative Commons Attribution 4.0 International License

Development of Acoustic Devices Functionalized with Cobalt Corroles or Metalloporphyrines for the Detection of Carbon Monoxide at Low Concentration

¹ Meddy VANOTTI, ¹ Virginie BLONDEAU-PATISSIER, ¹ David RABUS,
¹ Jean-Yves RAUCH, ² Jean-Michel BARBE, ¹ Sylvain BALLANDRAS

¹FEMTO-ST Institute, 26 chemin de l'Épitaphe, 25030 Besançon cedex, France

²4ICMUB, 9 avenue Alain Savary, 21078 Dijon, France

E-mail: meddy.vanotti@femto-st.fr, virginie.blondeau@femto-st.fr, david.rabus@femto-st.fr, jyves.rauch@femto-st.fr, Jean-Michel.Barbe@u-bourgogne.fr, sylvain.ballandras@femto-st.fr

Abstract: Progresses in synthetic chemistry methodologies has pushed to develop a large variety of artificial receptors of particular interest for chemical sensor applications. We investigate here the behavior of gas sensors based on surface acoustic wave (SAW) devices. The use of Love waves that are specially sensitive to surface perturbation enables to exploit the molecular recognition processes occurring in non conductive sensing layers of cobalt corroles [5,10,15-Tris(2,6-dichlorophenyl)corrolato]cobalt(III)] for CO detection. We have monitored phase variations of Love-wave-based delay lines under various operation conditions and studied the detection efficiency of a differential version of our sensors. A test bench also has especially been developed to allow for the regeneration of the sensor by freeing the CO trapping sites and therefore to provide an accurate control of the operation conditions. The detection threshold reached using the proposed SAW sensor is experimentally found below one ppm.

Keywords: SAW sensor, Love wave, Gravimetric effect, CO detection, Carbon monoxide.

1. Introduction

Carbon Monoxide (CO) is produced in various industrial and current-life processes by incomplete combustion of organic materials. It is a colorless, odorless, tasteless and toxic gas that is highly reactive with living tissues. Because of its properties, it is naturally not detectable by human olfaction.

Its toxicity and undetectability make it a dangerous compound known as the “silent killer”. This observation leads to the necessity of developing devices able to detect the presence of CO in the air.

A crucial point of the development of such sensors is the functionalization of its sensitive surface with chemical processing allowing the trapping of CO molecules. In this context, new materials such as metallo-porphyrins and metallo-corroles have been developed [5-8, 9]. These compounds behave as the hemoglobin molecule which is the natural receptor involved in CO poisoning. These types of macro-cycles interact with the toxic gas by coordination to the central metal atom.

In principle, gravimetric sensors disregard the electronic properties of the absorbing layer; only the mass variations are detected by the molecular adsorption. Among gravimetric sensors, quartz microbalances are the most exploited components for their simple preparation and operation. However, the development of lab-on-chip analysis devices is currently expected as another way to investigate different solutions on that topic. Surface acoustic waves (SAW) have so received a strong interest during the last decades for gravimetric detection.

In this paper, the properties of gas sensors based on Love wave devices that can accurately detect a toxic gas concentration in atmosphere are investigated by using the properties of non-conductive sensing layers. By using functionalized SAW devices, we observe a few second time response when switching from air to CO polluted atmosphere, with a phase shift several times larger than the baseline noise level.

The theoretical background of the proposed development is first presented with a brief recall of the sensor and system operation principles. The device functionalization and experimental assessment of the system operation as well and result discussions are then reported, preceding the paper's conclusion.

2. Basic Principles of the Sensor

As explained in Introduction, this work is focused on the use of stratified devices that permit the use of Love waves for the development of a CO micro-balance. The well-known sensitivity of Love waves to gravimetric effects [3-4] and the fact that shear waves are not radiated in fluids render this kind of device particularly attractive for gas detection. The mass sensitivity (also called gravimetric sensitivity) of SAW devices is given by (1):

$$S_m = \frac{\Delta f}{f_0} \cdot \frac{A}{\Delta m} \quad (1)$$

where f_0 is the resonant frequency of the unperturbed SAW sensor, A is the chemically active surface, Δm and Δf are the mass and frequency variations, respectively. In case of SAW sensors (Fig. 1.) working at 125 MHz, the mass sensitivity is theoretically ten times higher than bulk acoustic wave (BAW) Quartz-crystal-MicroBalance QMB (i.e. 250 cm²/g vs 25 cm²/g). In the present development, we therefore have been using Love-wave delay lines operating at 125 MHz and exhibiting a bandwidth of about 1 MHz. We note that the measurement of the frequency shift induced by mass loading of the chemically active surface (where the wave propagates) of these delay lines is preferably achieved using a synchronous detection approach for which the excitation and detection are achieved at the frequency center of the delay line response and by tracking the resulting phase shift [10]. As the phase of the Love wave is almost linear near the center of the delay line transfer function and considering very small mass changes preventing any dispersive effects, it is possible to directly correlate its changes with the mass load deposited on the said active surface using a proportionality factor. It is then possible to monitor the phase shift of the wave induced by the mass loading with high accuracy [10].

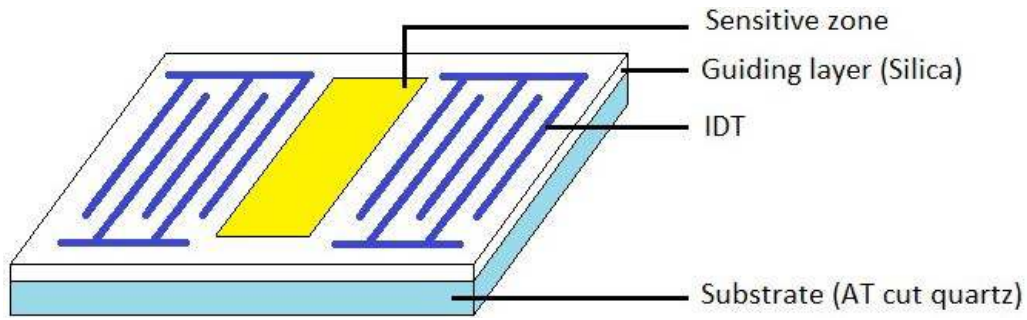

Fig. 1. Scheme of SAW sensor used in delay line configuration.

The Love-wave devices (Fig. 2.) used for the gravimetric detection consists in delay lines built on (AT,Z) cut of quartz substrate. A 2.5 μm thick silica overlay is deposited onto the interdigitated transducers (IDTs) providing a propagation path which permit the guidance of the acoustic wave with a minimum loss of the acoustic energy along the propagation. The Love wave is generated and detected using respectively inverse and direct piezoelectric properties of quartz. The transducers consist in IDTs composed of 50 pairs of electrodes (4-finger-per-wavelength) made of 200 nm thick evaporated aluminum. The grating period is 10 μm , i.e. a wavelength close to 40 μm yielding a frequency operation in the vicinity of 125 MHz as the wave velocity approaches 5000 $\text{m}\cdot\text{s}^{-1}$.

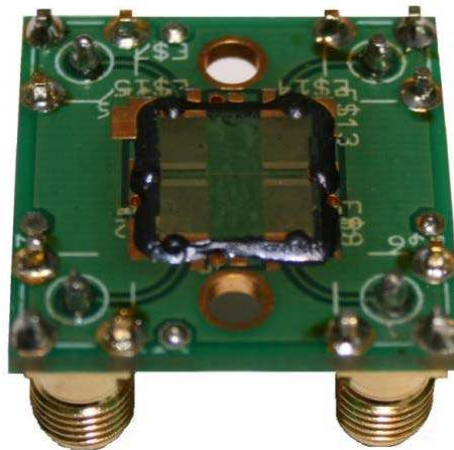

Fig. 2. Photograph of the SAW device using Love waves at 125 MHz.

3. Experiments

3.1. Functionalization of the SAW Sensor's Sensitive Area

The sensitive layers deposited onto the devices used here are composed of cobalt corroles (Fig. 3.). In previous studies [11] the CO trapping capability of different compounds such as porphyrines have been investigated. The corroles are preferred since it presents three bridging carbon atom upon two pyrolic units instead of four. This contraction of cycles gives the corroles special properties. Actually, the macrocycle cavity is smaller than with porphyrines and the central metal atom is stabilized in a larger oxidation degree. This results in a stronger coordination of the CO molecule with the cobalt atom at the center of the macrocycle. In addition, contrary to porphyrines, cobalt corroles do not decompose when exposed to humidity [8]. This behavior fits well with the long term use of a sensor.

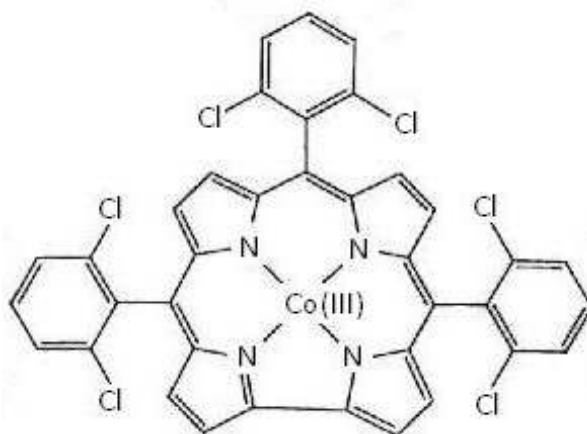

Fig. 3. Cobalt corroles used for the functionalization of the sensors.

These cobalt corroles were synthesized following literature method [8, 9]. The obtaining of the sensitive compound can be made either by the synthesis of a precursor ligand followed by its metalation using cobalt diacetate or directly from a cobalt ion. However, the first way will be preferred since it gives rise to a more sensitive compound [9].

The cobalt (III) corroles have been fully characterized by X-ray photoelectron spectroscopy. Thin films of this compound were deposited onto the surface of the delay lines by spray coating. Cobalt corroles [5,10,15-Tris(2,6-dichlorophenyl)corrolato]cobalt(III), were dissolved in a proper solvent at 10^{-3} M in dichloromethane. In order to control the amount of deposited metallocorroles, the resonance frequency of a QMB was measured on-line during the deposition process via a high stability frequency counter. A frequency variation of about 1 kHz was obtained for all deposited layers. XPS characterizations of the device sensing surface have been performed before and after the corrole spray coating, providing evidences of the presence of the sensitive compound onto the surface of the device (Fig. 4.). The XPS spectrum relative to the bare device shows the presence of Si and O at its surface. After the sensitive layer deposition, it is possible to observe two new peaks: one is characteristic of orbital 1s of the nitrogen atoms and the other denotes the presence of Co (difficult to detect on such wide-range scan but completely recognizable considering its own energy range). This observation is in agreement with the fact that in the corroles, 4 atoms of nitrogen surround the organometallic atom. The peaks relative to the silica substrate are less important after the deposition. Moreover, carbon quantity clearly increases, proving the presence of an organic layer on the surface of the device.

3.2. Experimental Gas Sensing Setup

It has been shown that the cobalt corroles can trap carbon monoxide by coordination to the central cobalt atom. Moreover, these compounds exhibit a remarkable affinity to CO versus O₂ and N₂ that are the two main compounds that compose the atmosphere of the sensor when used in standard conditions. One can note that the interaction between the corroles and the gas to detect is reversible and its selectivity is improved by the application of vacuum conditions in the atmosphere of the sensor when exposed to carbon monoxide. Consequently, the test bench has been developed to allow for placing the reaction chamber under primary vacuum conditions to promote the regeneration of the CO trapping sites. In Fig. 5, the experimental test bench specially designed for high sensitivity carbon monoxide detection is presented.

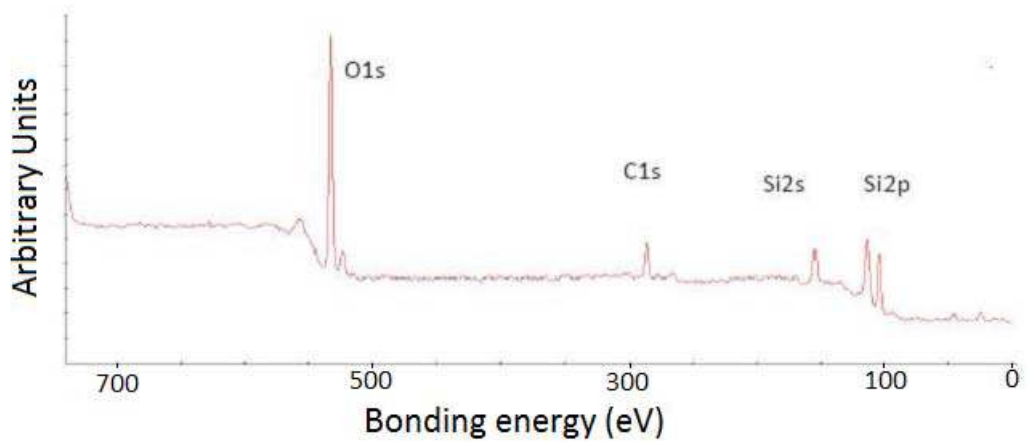

(a)

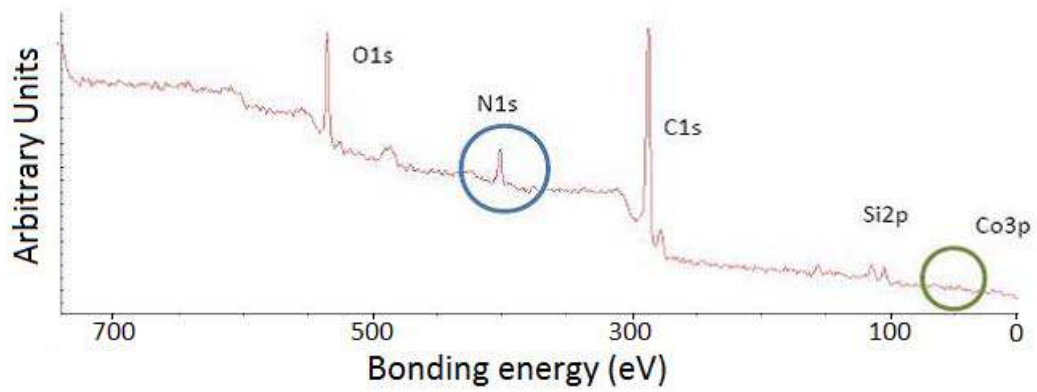

(b)

Fig. 4. XPS spectrum obtained before (A) and after (B) cobalt(III) corroles spray coating on SAW device.

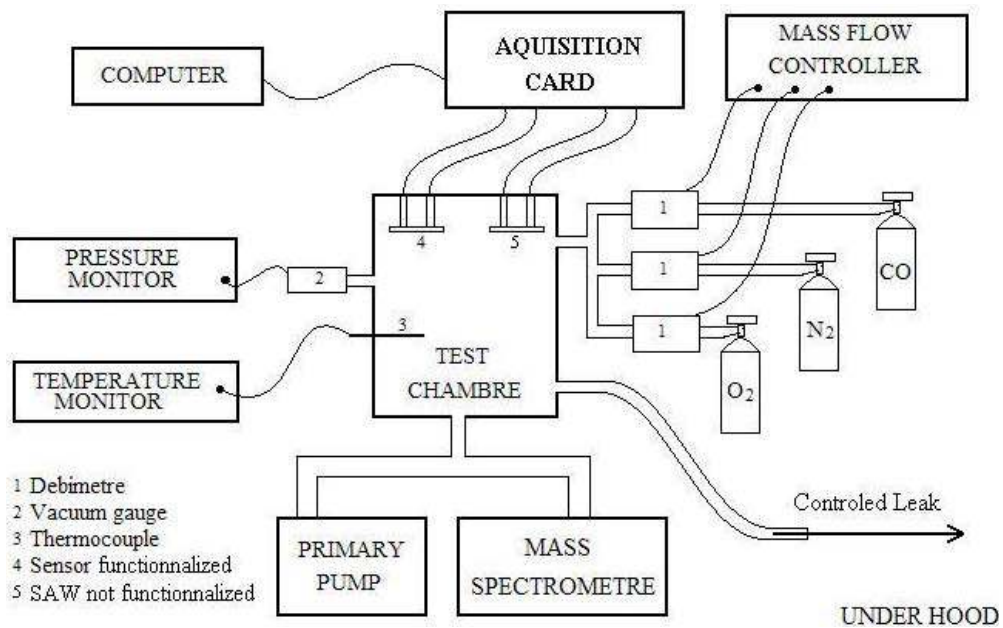

Fig. 5. Scheme of our specific toxic gas detection cell.

During the tests, Love-wave-based sensors are exposed to changes of several experimental parameters (temperature, flow, pressure, presence of gas). In order to extract the information concerning CO adsorption, a specific differential setup is used [10]. By this way, influence of experimental parameter changes limiting or even preventing the CO detection is minimized.

The cell is equipped with three mass flow meters driven by a controller allowing for the dilution of CO with N₂ and O₂. Moreover, a primary pump provides vacuum conditions yielding a faster regeneration of the sensitive area of the sensors as explained above, making it reusable. Several monitoring element are equipping the test chamber in order to control its internal pressure, temperature and flow conditions.

3.3. Measurement and Differential Acquisition

Since the acoustic wave generated by the transducers is a surface acoustic shear wave with a horizontal polarization, it reveals extreme sensitivity to perturbations occurring at the surface of the device. Any modification of the acoustic wave propagation conditions inside or above the silica guiding layer perturbs the physical characteristics of the wave and more specifically its phase velocity. Using a network analyzer, one can determine the transfer function of the device and hence monitor the phase shift induced by mass adsorption within the sensitive layer. By this way, information about the CO loading onto the device's surface is simply and rapidly obtained. By a matter of fact, increasing the deposited mass at the device's surface leads to a shift-down of the delay line synchronism frequency. Since the phase of the delay line is almost linear along frequency near the transfer function center, the frequency down-shift due to mass adsorption can be detected by a phase shift at constant frequency. Fig. 6 illustrates the way the measurements are achieved.

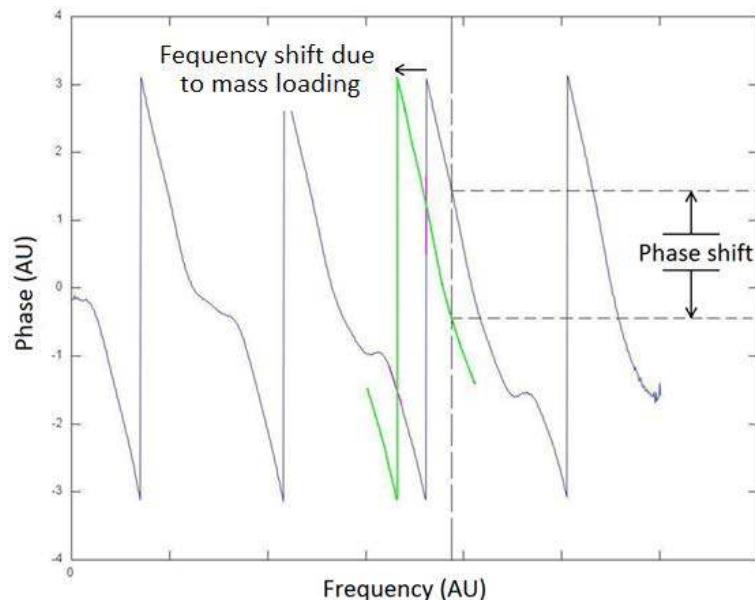

Fig. 6. Measurement of the phase shift consecutive to the mass loading on sensor (transfer function in phase before (in blue) and after (in green) CO loading).

For all the achieved measurements reported here, the CO adsorption was characterized by mean of this phase shift monitoring which is directly representative of the phase velocity changes of the wave. We will particularly consider the velocity of the phase changes. The validity of such a procedure will be evidenced later in the “Experiments” section. Using this information allows for a fast determination

(some tenth of seconds) of the CO concentration in the tested gas, contrary to the total phase shift evaluation that needs much more time to be achieved since the steady state takes several tenth of minutes to be reached. As a consequence, CO detection will be characterized by the phase shift velocity at the beginning of the phase shift decrease.

As mentioned above, a differential acquisition of the phase shift is performed to minimize the influence of correlated parameters. As explained above, such a differential measurement requires two delay lines composing the sensor. One of these delay lines is kept clean as a reference and the other one is covered by spray coating with cobalt corroles yielding it sensitive to the presence of CO. The response of the bare device and the functionalized one are respectively measured. A dedicated, embedded instrument based on a full software control has been developed for the open loop monitoring of delay lines, providing stability and accuracy comparable to a closed-loop approach (based on resonators). A Direct-Digital-Synthesizer (DDS)-based frequency source provides a flexible RF probe signal, while a low noise phase detector is fed by an amplitude-controlled signal. This low noise electronics is used in parallel with a flexible wide-band I/Q demodulator for the preliminary characterization of the transfer function of each sensor and selecting the optimum working frequency used throughout the gravimetric detection experiment. In order to perform differential measurements, both of the two transducers are probed simultaneously. Since the two devices experience different working conditions, either due to manufacturing differences or due to the sensing layer coating, two independent probe signals are generated using two independent detection tracks. Each RF signal is split between a reference channel and a programmable attenuator tuned to generate an output signal with a power close to that going through the SAW delay line used as measurement line. This instrumentation features enough stability and accuracy to allow for the monitoring of the phase. During the experiments, the transition from primary vacuum (10^{-5} bar) to atmospheric pressure by gas injection (nitrogen or air) is accompanied by a decrease of temperature and obviously by a modification of the chemical composition of the atmosphere in the test chamber. Even if these modifications are much less effective than a CO adsorption on the sensor response, it is still likely to perturb the measurement of the CO concentration on the test cell. As one can see in Fig. 7, the use of the differential setup allows for minimizing the influence of changes of such correlated parameters. Indeed, the differential signal exhibits a ratio of 8.2 (-0.23/-0.028) between the phase shift velocity consecutive to the injection of CO and the injection of N_2 contrarily to the signal from the detection branch alone which gives a ratio of only 2.1 (-0.25/-0.12).

4. Results and Discussion

Results concerning the detection of low concentrations of carbon monoxide diluted in nitrogen or air are reported in this section. We first present the preliminary results that have evidenced the capability of the sensor to detect the presence of high CO concentrations under vacuum. Then, the detection of this gas at low concentration and at atmospheric pressure in presence of different gas is reported.

4.1. Preliminary Tests

Preliminary tests were performed with high CO concentration in order to check the device signal dynamics when loaded with a maximum concentration of the tested gas. The toxicity of CO at such concentrations being so high, the experiments were led under vacuum to avoid any leakage in the working environment. Starting from a 10^{-5} bar vacuum, the injection of CO is then achieved, reaching a pressure of 10^{-1} bar.

Fig. 8 shows the signal directly from the detection branch alone (without differential processing), when exposed to CO concentration from 200 to 13 ppm. The functionalized Love-wave sensor allows for the

measurement of concentrations of some tens of ppm of carbon monoxide. The experiments show that the detection of lower concentrations is hardly achievable using the detection branch alone. For this first test campaign, the chamber's volume was about 14 liters. This dimension was too large considering the targeted CO concentration (some ppm) and the injected gas flow (100 sccm). It was then necessary to wait several minutes before the homogenization of the melting gas, yielding severe difficulties for the sensing element to accurately detect CO concentration smaller than 10 ppm.

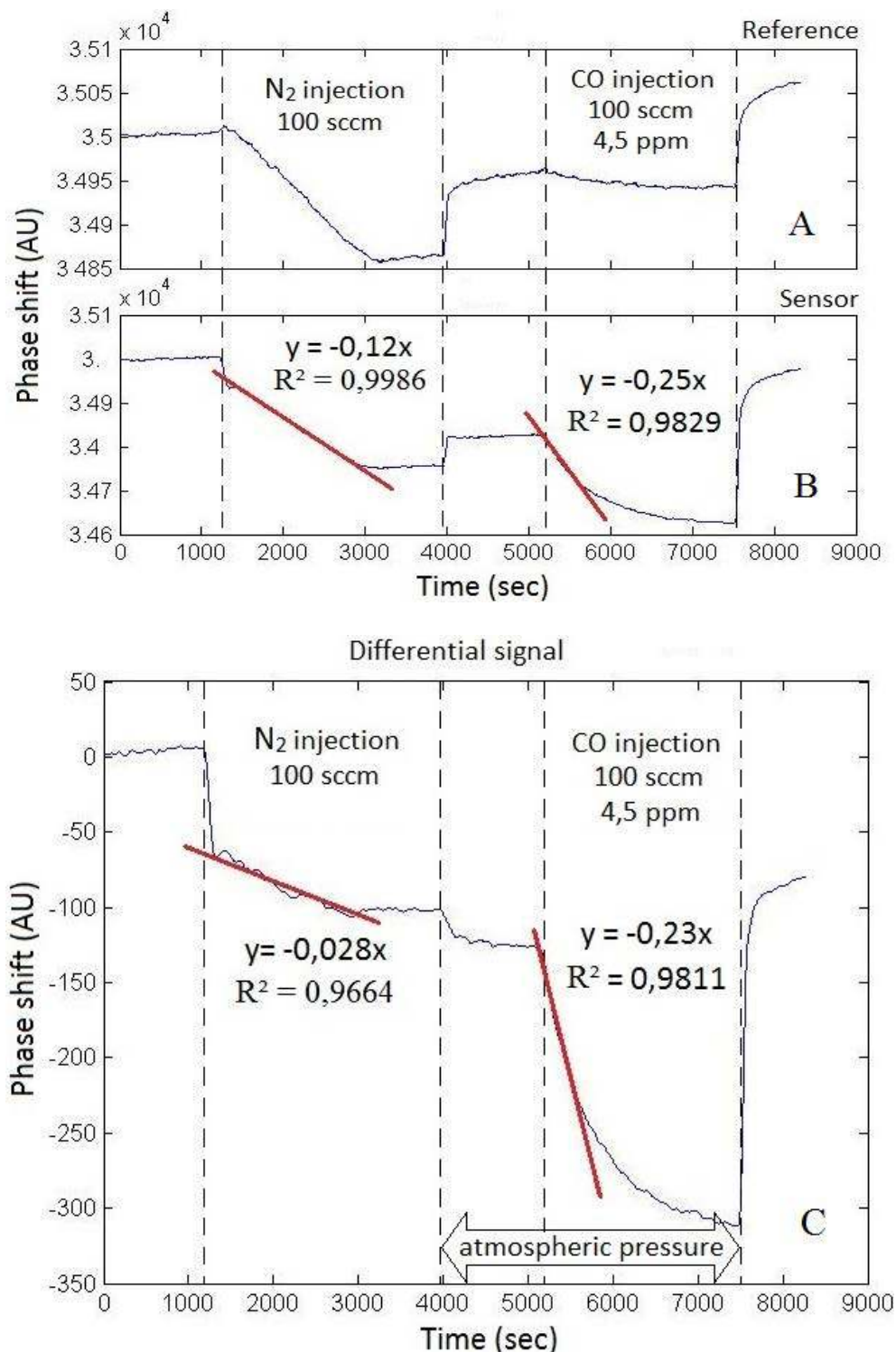

Fig. 7. A differential acquisition system is used to minimize the influence of changing experimental parameters that prevent the CO detection: A) Phase variation obtained with bare device used as reference; B) phase variation of functionalized device with cobalt corroles; C) Difference between two previous signals.

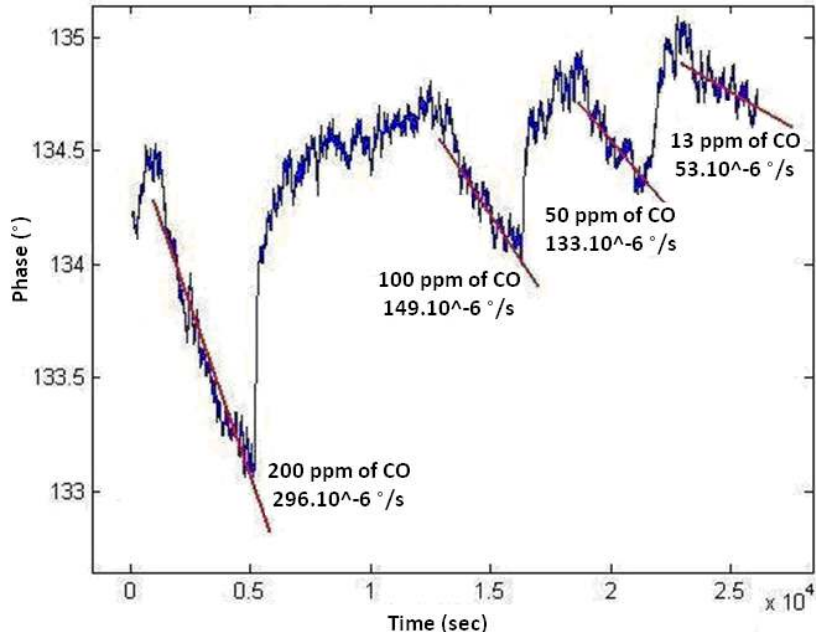

Fig. 8. Detection of gas exhibiting a high CO concentration using the proposed Love-wave device functionalized with cobalt corroles.

4.2. Detection of Low Concentrations of Carbon Monoxide

The capability of our functionalized device to detect ppm concentrations of carbon monoxide in different experimental conditions is demonstrated here. A dilution of the toxic gas with nitrogen is first performed, and the experiments were first led with low pressure in the test chamber (10^{-5} bar). Since the sensor is expected to operate under standard room conditions, the tests have been performed at atmospheric pressure and in presence of air in order to more closely simulate the final conditions of use of such a sensor.

- Experimentations performed at low pressure:

The selectivity of the cobalt corroles for CO versus O_2 and N_2 is improved when the interaction between the corroles and the different gases occurs in low pressure condition [8]. Indeed, under 5 Torr, the selectivity of the corroles to CO is considered infinite. The selectivity of the sensitive compound is characterized by (2);

$$M = (P_{1/2})_{O_2} / (P_{1/2})_{CO}, \quad (2)$$

where $(P_{1/2})_i$ is the partial pressure at half saturation of the “i” gas in the sensitive layer. One can notice that the larger M is, the greater the affinity for carbon monoxide is. Its value decreases while the pressure increase to reach 2557 for a pressure equal to 780 Torr. Detection of low CO concentration has so been performed first under vacuum (10^{-2} Torr) and then, at atmospheric pressure. In that purpose, CO is first diluted with nitrogen by mean of two mass flow meters driven by a controller. The injection of both CO and N_2 in the test chamber with controlled flows allows for getting melting gas with different CO concentrations. The gas injected in the chamber is so detected when flowing at the surface of the device without increasing of the pressure since the primary pump assures vacuum condition upon the experimentation. The obtained results are shown on Fig. 9 and 10.

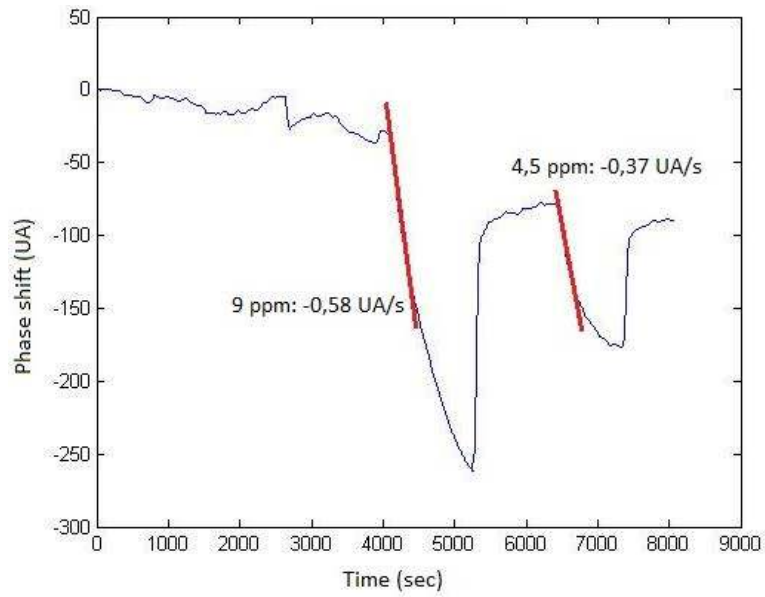

Fig. 9. Phase shift measurement under vacuum and CO injection.

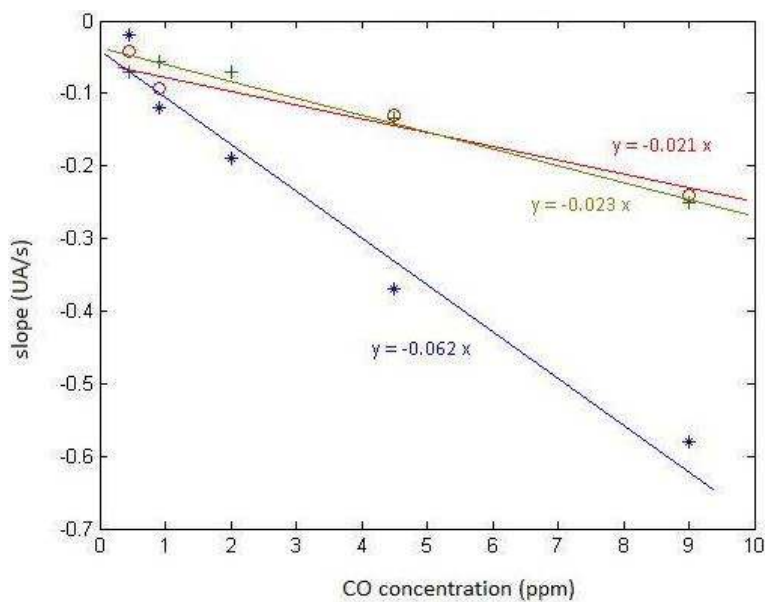

Fig. 10. Phase shift velocity measured under vacuum VS concentration of CO.

The resulting differential signals are shown in Fig. 6 as well as the phase shift velocities calculated by linear regression ($R^2 > 0.98$). Performing the tests under vacuum enables the system to achieve a detection of CO concentration of about 450 ppb.

In Fig. 10, the slopes values are plotted versus the corresponding CO concentrations. One can see that the results of the three series of test exhibit a linear behavior but the slope of these three series are not the same. Judging from this observation, one can say that the repeatability of the experimentation under vacuum isn't evidenced even if the coherence of the results is established upon each series of test.

- Experimentations performed at atmospheric pressure and using nitrogen for dilution:
 In order to get even closer to the final conditions of the sensor operation, the previous tests have been performed at atmospheric pressure. Knowing that the oxygen is the main compound capable to perturb the trapping of CO in the sensitive layer, nitrogen is first used for the dilutions. Fig. 11 and 12 show the results relative to these experiments.

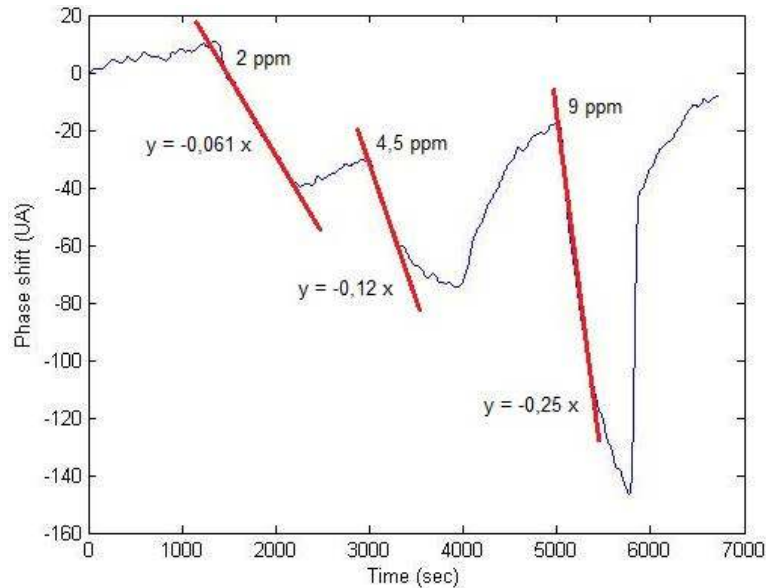

Fig. 11. Phase shift measurement under atmospheric pressure and in presence of CO diluted with nitrogen.

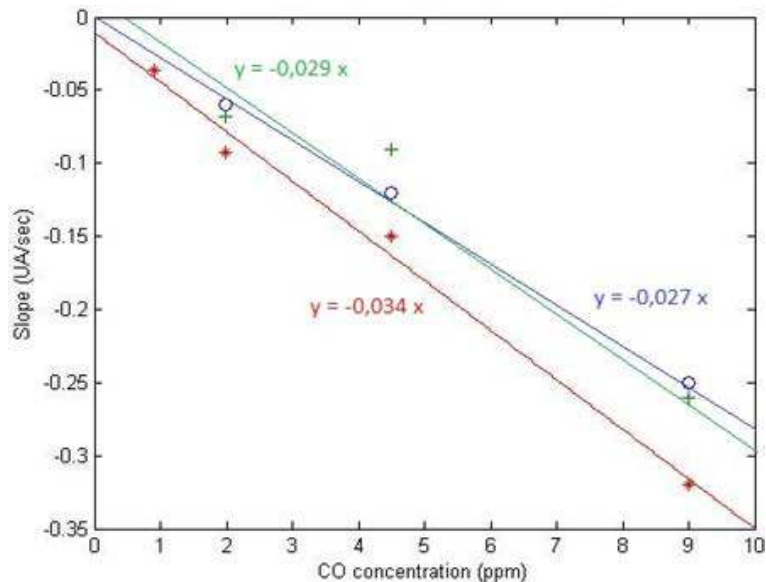

Fig. 12. Phase shift measurement under atmospheric pressure VS concentration of CO.

Fig. 12 shows that the sensor's response still presents a linear behavior for each series of test. Furthermore, the slope obtained on the differential signal versus the concentration of CO is nearly the same from one series to another. In addition, we emphasize that the sensitivity of the device is lower at atmospheric pressure than under vacuum, as expected. Indeed, operating at atmospheric pressure yields a 900 ppb CO concentration detection barrier. This observation allows one to infer that the

detection at atmospheric pressure allow the repeatability of the experiments but scarifying the sensitivity of the sensor by a factor of 2.

- Experimentations performed at atmospheric pressure and with synthetic air used for dilution of carbon monoxide:

Still in the purpose of approaching the actual working conditions of the sensor, the later has been tested under atmospheric pressure in presence of air. Exposing the sensor to the air before the injection of CO can also validate the fact that cobalt corroles are able to coordinate CO molecules even if previously and simultaneously exposed to oxygen. The air used for this experiment has been synthesized from pure oxygen (20 %) and pure nitrogen (80 %). Figs. 13 and 14 report the observations made concerning the capability of the sensitive layer to adsorb CO in presence of oxygen.

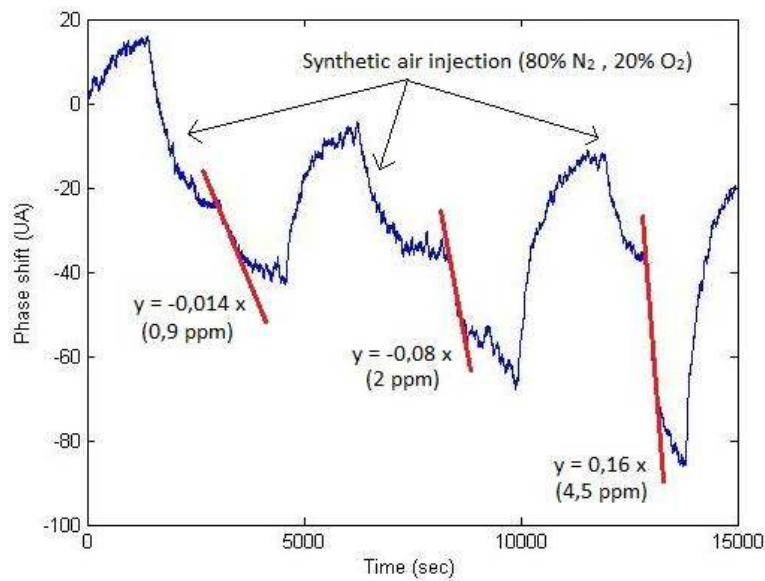

Fig. 13. Phase shift measurement at atmospheric pressure and with CO diluted in synthetic air.

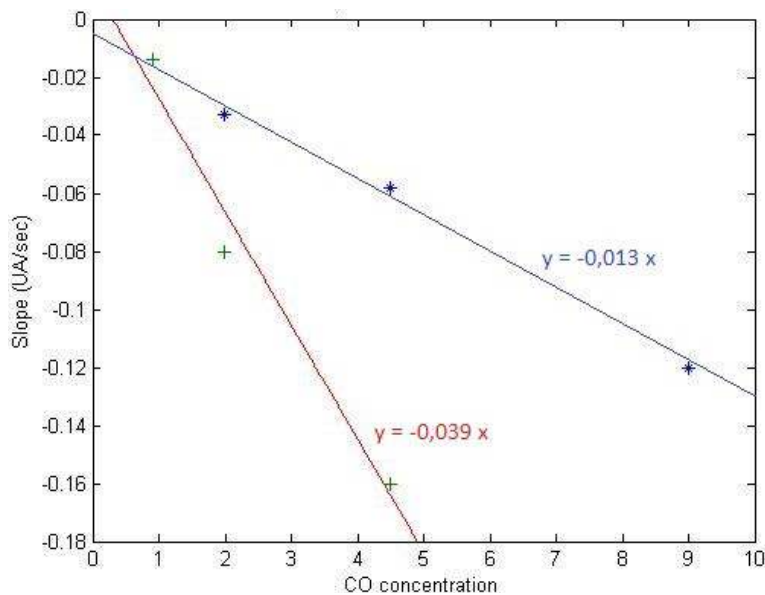

Fig. 14. Phase shift velocity under atmospheric pressure vs. concentration of CO diluted in air.

As shown in Fig. 14, the use of the sensor in presence of air does not degrade the detection threshold of the device and therefore a 900 ppb detection barrier also is met. The repeatability of the experiment was not observed in the present case. However, a linear correlation between the phase shift velocity and the CO concentration in the gas is still observed.

- Influence of a variation of temperature on the sensor's response:

Since Love-waves exhibit a temperature coefficient of frequency (TCF) close to 0 ppm.K^{-1} , temperature changes should moderately influence the propagation of the acoustic wave. However, one can observe that the organic sensitive layer is influenced by temperature variations. Consequently, even if a variation of temperature has a rather small influence on the substrate, it can affect the sensor response as shown in Fig. 15.

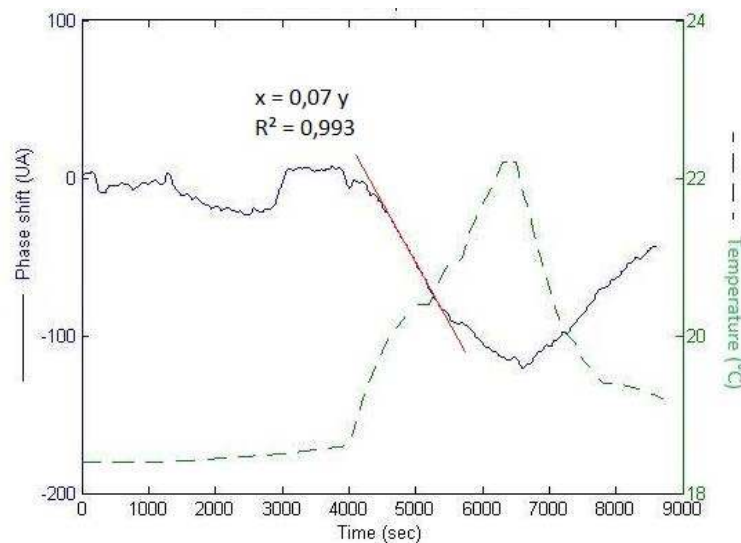

Fig. 15. Phase shift due to a variation of temperature of the sensor's atmosphere without any toxic gas injection.

- Detection of an accumulation of carbon monoxide:

It's known that an overwhelming majority of intoxication by carbon monoxide occurring in everyday life follows from regulation issue on heating system that results in faster or slower accumulation of toxic gas in the indoor air. Until now, the capability of our CO detection device has been determined to detect a progressive gas accumulation within the sensitive layer. Fig. 16 shows the results obtained concerning that issue.

We can see that the injection of carbon monoxide at 9 ppm during 30 seconds induces a phase shift of about 4AU ($1\text{AU} = 3.6 \times 10^{-3} \text{ }^\circ$). One also can observe that just after this first injection, the phase recovers the same value as before the injection ($\text{Phase (before injection)} - \text{Phase (after injection)} = 0.5\text{AU}$). This behavior can be explained by the fact that the injection of CO is instantaneously followed by the application of a nitrogen flow inducing desorption of the toxic gas from the sensitive layer. As shown in the Fig. 16, longer exposures of the sensor to CO with a similar concentration induce a quiet larger phase shift (7AU and 12AU). In addition, one must mention that just after the second injection that last two minutes, the injections of both CO and nitrogen were stopped. By operating along this way, there is no nitrogen flow at the surface of the device after the mass loading and consequently no desorption of carbon monoxide. It is therefore possible to keep the phase unchanged at the value reached after the CO injection. This last experiment allows concluding that the system enables the detection of an accumulation of toxic gas and therefore answering one of the main requirements for such a sensing element.

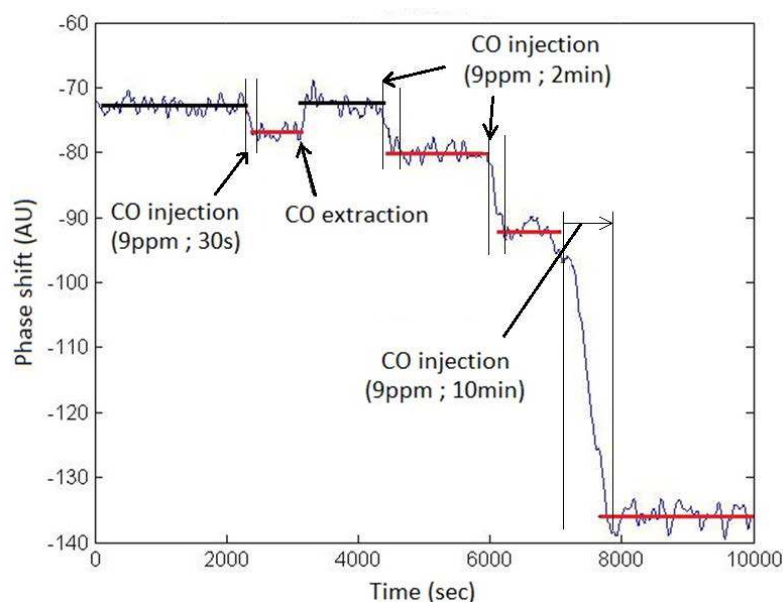

Fig. 16. Phase shift (in arbitrary units) due to CO pulsed injection using nitrogen for dilution.

5. Conclusion

As a conclusion, the use of surface acoustic wave device coupled with the exploitation of new materials for the selective trapping of carbon monoxide enables one to detect measure and monitor a wide range of CO concentrations. Indeed, the use of cobalt corroles combined with acoustic devices based on Love waves using quartz substrate operating at 125 MHz has allowed for selective detections of ppm concentration of carbon monoxide. In addition, a test bench has been developed to perform the detection under controlled conditions of pressure, temperature and gas flow. The obtained results are promising and allow for sub-ppm CO concentration measurements. In order to improve our detection device, studies concerning the deposition process of the sensitive layer are engaged. Moreover, the use of acoustic resonators working at higher frequency will be tested as it is expected to increase the mass sensitivity and the signal/noise ratio.

Acknowledgements

The authors are grateful to Professor Roberto PAOLESSE and Doctor Luca TORTORA for performing the deposition of the cobalt corroles onto our devices.

References

- [1]. Ballantine D. S., White R. M., Martin S. J., Ricco A. J., Zellers E. T., Frye G. C., Wohltjen H., *Acoustic Wave Sensors*, Academic Press, San Diego, CA, USA, 1997.
- [2]. Sauerbrey F., Verwendung von Schwingquarzen zur Wägung dünner Schichten und Microwägung, *Zeit. Physik*, Vol. 155, 1959, pp. 206–222.
- [3]. Harding G. L., Du J., Dencher P. R., Barnett D., Howe E., *Sensors and Actuators A Physical*, 1997, Vol. 61, Issue 1-3, pp. 279-286.
- [4]. Jakoby B., Vellekoop M. J., *Sensors and Actuators A Physical*, 1998, Vol. 68, Issue 1-3, pp. 275-281.
- [5]. Paolesse R. and al., Porphyrin Based Chemical Sensors, *Encyclopedia of Nanoscience and Nanotechnology*, H. Nalwa Ed., American Science Publishers, 2004, Vol. 9, pp. 21-43.
- [6]. Friedt J. M. and al., Design and Use of Wafer Level Fluidic Packaging for Surface Acoustic Wave Sensors, *IEEE*, May 2007, pp. 369-373.

- [7]. Di Natale C. and al., Development of porphyrins based sensors to measure the biological damage of carbon monoxide exposure, in *Proceedings of the IEEE Sensors Conference*, Toronto, Canada, 2003.
- [8]. Barbe J. M., Canard G., Brandès S., Jérôme F., Dubois G. et Guillard R., Metalloporphyrins as sensing components for gas sensors: remarkable affinity and selectivity of cobalt(III) porphyrins for CO vs. O₂ et N₂, *Dalton*, 2004.
- [9]. Jérôme F., Dubois G., Brandès S., Canard G., Barbe J. M., Guillard R., Roux-Fouillet B., Ledon H., Matériaux pour le piégeage sélectif du monoxyde de carbone, *European Patent Office*, EP 1 414 823 B1, 2007.
- [10]. Rabus D. and al., A High Sensitivity Open Loop Electronics for Gravimetric SAW Sensors, *EFTF*, 2010.
- [11]. Vanotti M., Blondeau-Patissier V., Ballandras S., Love Wave Sensors Functionalized with Cobalt Porphyrins or Metalloporphyrins Applied to the Detection of Carbon Monoxide, in *Proceeding of the SENSORDEVICES '11 Conference*, Nice, France, August 2011.