



HAL
open science

Sophie, an FDTD code on the way to multicore, getting rid of the memory bandwidth bottleneck better using cache.

Olivier Cessenat

► To cite this version:

Olivier Cessenat. Sophie, an FDTD code on the way to multicore, getting rid of the memory bandwidth bottleneck better using cache.. 2009. hal-00778172

HAL Id: hal-00778172

<https://hal.science/hal-00778172>

Submitted on 18 Jan 2013

HAL is a multi-disciplinary open access archive for the deposit and dissemination of scientific research documents, whether they are published or not. The documents may come from teaching and research institutions in France or abroad, or from public or private research centers.

L'archive ouverte pluridisciplinaire **HAL**, est destinée au dépôt et à la diffusion de documents scientifiques de niveau recherche, publiés ou non, émanant des établissements d'enseignement et de recherche français ou étrangers, des laboratoires publics ou privés.

SOPHIE, AN FDTD CODE ON THE WAY TO MULTICORE, GETTING RID OF THE MEMORY BANDWIDTH BOTTLENECK BETTER USING CACHE.

OLIVIER CESSENAT*

Abstract. FDTD codes, such as Sophie developed at CEA/DAM, no longer take advantage of the processor's increased computing power, especially recently with the raising multicore technology. This is rooted in the fact that low order numerical schemes need an important memory bandwidth to bring and store the computed fields. The aim of this article is to present a programming method at the software's architecture level that improves the memory access pattern in order to reuse data in cache instead of constantly accessing RAM memory. We will exhibit a more than two computing time improvement in practical applications. The target audience of this article is made of computing scientists and of electrical engineers that develop simulation codes with no specific knowledge in computer science or electronics.

Key words. FDTD, multicore, cache reuse, memory bandwidth, code optimization

AMS subject classifications. 35L05, 65Y20, 68P05, 68U20, 68W40, 65F50

1. Introduction. At CEA, the French Nuclear Agency, we develop yet another FDTD (Finite Difference in Time Domain) code, called Sophie, for electromagnetic simulations of the Laser MegaJoule (LMJ) device. To achieve realistic three-dimensional simulations, we need to be able to make computations on tens of billions of cells. This challenging goal not only demands a massively parallel machine (Tera 10, see www.top500.org), but also a very efficient implementation to reduce the computation time on an always very busy High Performance Computing centre. Current major LMJ simulations cost roughly 500 Euros in electric power consumption. Improving the computing's efficiency is an economic issue.

FDTD codes date back to the late sixties with their numerical scheme first presented in [30], becoming very popular in the eighties with the appearance of the first Cray vector super-computers that made three dimensional simulations affordable [26]. Those codes were very fast due to a perfect vectorization level, particularly efficient on large problems [1].

Nowadays, very large simulations are performed using many mass market personal computers (PCs) components. On those hardware platforms, FDTD codes, as well as all low order solvers, are not able to take advantage of the still up-to-date Moore's law that applies to the processors peak's computing power. This is rooted in the fact that low order solvers need an important bytes to flops ratio (the program balance as described in [8]), typically 4 for an FDTD code in single precision. Ever since thirty years, whereas CPU speed doubles in average every 18 months, memory bandwidth takes around 33 months to double according to [7]. Moore's law validity in the future will probably rely on increasing the number of cores per processor whereas there seems to be no plan to make cores manage the memory accesses independently.

Since the mid-nineties, memory bandwidth bottleneck is seen as the major obstacle to scientific computing generally made of sparse matrix to vector products where modern processors spend more than 80% of their time waiting for data [1]. This is visible to the scientific kernels included in the Specfp benchmarks (www.spec.org) such as GemsFDTD for the 3D FDTD. Much work is being performed to overcome this memory bandwidth bottleneck through very clever cache hierarchies and compiler's

*CEA/DAM/CESTA, F-33114 Le Barp, France.

optimizations (refer to [8] and [29] for cache use optimizations and to [21] for register pressure in multidimensional loops). These optimizations provide a real benefit on many basic linear algebra applications, but their essential weakness is that they lack a global view of the scientific application (they are very often limited to a procedural optimization).

Another possibility is to use specific hardware such as FPGAs where data bandwidth is provided in parallel as in [27]. But specific VLSI programming is far too complicated for computing scientists with no knowledge in electronics. Another drawback of specific electronics is that simulation code's lifetime often exceeds twenty years, whereas electronic devices cannot last more than two years. CPUs life cycle is around four years, but high level programming languages such as FORTRAN limit the cost of porting codes from a CPU to another. Recently, using GPUs (Graphics Processing Units) is seen as an alternative or a complement to general CPUs with the development of CUDA, an NVIDIA C-styled language [22]. Even though NVIDIA's products lifetime is typically two years, the CUDA language is expected to be supported during generations of products. Depending on the application's computing kernel's features, a speed gain of 10 to 50 can be reached. For instance, on the FDTD kernel, a factor of 10 is obtained in [22]. The drawbacks are that GPUs typically provide more than an order of magnitude less storage than the system's RAM and that the kernel's efficiency is masked by the other parts of the application, making the use of a GPU inefficient if the output of the device's computation has to be transferred into RAM through the PCI bus too often.

On the long run however, vendor independent environments, such as HMPP developed by "CAPS enterprise", aiming at providing standard directives, as with OpenMP, seem very attractive. Instead of providing a low level API to GPUs programming, HMPP takes advantage of the high level features related to the program. It then generates optimized GPU code using the low level vendor's API. It is further described in [28] and [3]. It also provides a resource manager which is very useful in an SMP multi-GPU environment.

When optimization both at the hardware and at the compiler's level fail, computing scientists need to review their algorithms so that maximizing the processor's data cache use (and, if possible, data cache hierarchies) is taken into account at the software's design step preceding the implementation. This is not the first time that numerical schemes or computing algorithms must be reviewed to better suit the available underlying computing platforms. The Cray vector computers in the eighties gave a boost to linear algebra and the standard Galerkin methods such as the Finite Elements and the FDTD. The parallel machines era in the nineties demanded breakthroughs in the field of implicit solvers with domain decomposition methods. Today, high order methods with more flops per byte such as the Discontinuous Galerkin Method should address the broadening hardware's gap between CPU and memory bandwidth [2], at least on Cartesian meshes.

The aim of this article is to present techniques at the application's architecture level to naturally optimize the cache use as in [11] and [14], giving a computing scientist's point of view. These techniques apply on today's multicore processors that have enough cache. We believe our approach is original since we consider the algorithm as a whole, not merely one time step. Even though we focus on a time explicit scheme, the method can be adapted to domain decomposition iterative implicit solvers where the iterative steps play the role of the time steps.

Since optimization at the application level needs an insight on the application's

features, section 2 presents the basic framework for any FDTD code. The puzzling practical experiment is a parallel efficiency superior to 1 on mid-sized problems. A simplified (considering only one cache level with infinite bandwidth to processor's registers) theoretical analysis is presented section 3, with major expected speed gains. Confrontation with numerical experiments is shown section 4, first on the FDTD kernel then on the whole FDTD production code Sophie for electro-magnetics simulations at CEA. It demonstrates an enhancement of the computation speed by a factor two.

2. Basic framework issues. Section 2.1 presents the basics of the FDTD scheme. In section 2.2, we explain why FDTD codes struggle against the memory bandwidth bottleneck. The processor's peak computing power is only available when problem is small enough so that its fields fit in cache as explained section 2.3. In today's era of massive parallel machines, FDTD codes bear the advantage to be able to fit in cache when the number of computation nodes increases, as we see section 2.4. Thus, a parallel efficiency superior to 1 can be estimated and actually encountered on practical problems.

2.1. FDTD scheme overview. The Finite Difference in Time Domain is the discrete scheme, leapfrog in time and space, of the Maxwell equations in vacuum. Let $\nabla \times$ denote the curl operator, ε_0 be the permittivity of vacuum, μ_0 the permeability of vacuum. The Maxwell equations write:

$$\varepsilon_0 \partial_t \mathbf{E} - \nabla \times \mathbf{H} = 0 \quad [\text{Maxwell-Ampere}] \quad (2.1)$$

for the electric field evolution, and

$$\mu_0 \partial_t \mathbf{H} + \nabla \times \mathbf{E} = 0 \quad [\text{Maxwell-Faraday}] \quad (2.2)$$

for the magnetic field evolution.

These equations can be made fully antisymmetric with variables $\tilde{\mathbf{E}} = \varepsilon_0 \mathbf{E}$ and $\tilde{\mathbf{H}} = \mathbf{H}/c$ as follows:

$$\partial_t \tilde{\mathbf{E}} - c \nabla \times \tilde{\mathbf{H}} = 0 \quad (2.3)$$

$$\partial_t \tilde{\mathbf{H}} + c \nabla \times \tilde{\mathbf{E}} = 0 \quad (2.4)$$

The Yee space discretization is the integral form of these equations using Green's formula (refer to [4] for the mathematical framework) on faces of the mesh for Faraday's equation, on the edges for Ampere's equation, as detailed in [30]. Time discretization is a leapfrog scheme. Thus, updating the magnetic field in direction x is (refer to [26] or [1] for the other fields):

$$\begin{aligned} H_{i,j+\frac{1}{2},k+\frac{1}{2}}^{n+\frac{1}{2}}(x) = & H_{i,j+\frac{1}{2},k+\frac{1}{2}}^{n-\frac{1}{2}}(x) + \frac{c\Delta t}{\Delta z_{k+\frac{1}{2}}} \left(E_{i,j+\frac{1}{2},k+1}^n(y) - E_{i,j+\frac{1}{2},k}^n(y) \right) \\ & - \frac{c\Delta t}{\Delta y_{j+\frac{1}{2}}} \left(E_{i,j+1,k+\frac{1}{2}}^n(z) - E_{i,j,k+\frac{1}{2}}^n(z) \right). \end{aligned}$$

The problem's numerical stability requires a perfect antisymmetry on the discrete equations which is true when solving equations 2.3 and 2.4 on a Cartesian mesh [10].

2.2. FDTD codes and memory bandwidth issues. Processor to memory throughput nowadays is typically 6.4 GB/s with DDR2-800 (JEDEC standard PC2-800, see www.jedec.org) or up to 12.8 GB/s with the latest DDR3 modules (JEDEC standard PC3-1600, abusively referred to as PC3-12800).

In FDTD codes, the maximum number of cells that we can compute with DDR2-800 is in practice typically 50 MC/s with 32 bits precision. This computing power is quasi independent of the processor's frequency and of the processor's number of cores.

This fact is well known from the Specfp 2006 benchmark with the GemsFDTD test module from the "Center for Parallel Computers" (PDC) at the Royal University of Stockholm, Sweden. In the bench description [1], many numerical experiments on different hardwares (IBM, Fujitsu, SGI, Intel) and an extensive analysis detail which is the best implementation for each platform. Apart from the Fujitsu vector super-computer, all machines have poor performance on large problems, poor related to the processor's peak speed. We strongly recommend the reader to refer to this article [1] to better understand facts that shall not be re-explained here.

The reader should not confuse Gems from PDC (that includes GemsFDTD) with the FDTD leading commercial software, massively parallel software as proven by tests on Blue Gene/L that targets petaflop computations [17].

Let us explain why FDTD codes demand a high number of bytes to flops ratio, considering one of the six FDTD triple loops implemented in the standard way as given in A. Taflov's handbook [26] p. 547 following Yee's numerical scheme [30]:

```
do k=1, nz; do j=1, ny; do i=1, nx-1
  hx(i,j,k)=hx(i,j,k)+ &
  & dz(k)*(ey(i,j,k+1)-ey(i,j,k))+dy(j)*(ez(i,j+1,k)-ez(i,j,k))
end do; end do; end do
```

To compute $hx(i,j,k)$ we need to fetch four electric field values and the magnetic field value itself, then store the result. This makes 6 memory accesses.

We do not deal with the geometrical coefficients $dz(k)$ and $dy(j)$ since we assume they fit in registers. Concerning the $dx(i)$ array used for the computation of $hy(i,j,k)$ and $hz(i,j,k)$, we assume it fits in cache. This is an important specific point of the Cartesian programming: the sparse matrix that updates the field is stored in one-dimensional arrays.

FDTD computations are most of the time performed in single precision, but not always. This is why we shall consider both single and double precision. A real float size in single precision is 4 bytes wide (32 bits), a double takes 8 bytes (64 bits).

Thus, using 6400 MB/s memory throughput, we compute in single precision (4 bytes), knowing there are 6 fields per cell and 6 data access per field:

$$\frac{6400}{4 \times 6 \times 6} = 44 \quad (2.5)$$

million cells per second (MC/s). In double precision, we can compute 22 MC/s. Of course, this analysis does not take into account the cache effect, which reduces the memory requirement. This is why, in practice, even for very large domains where cache benefits are reduced, computing speed is slightly higher.

On an Itanium II dual core processor at 1600 MHz, we can perform 4 floating point operations per cycle and per core, thus 12800 MFlops. In the above FDTD scheme, we need to perform 6 operations per field. We could expect to compute, knowing there are 6 fields per cell:

$$\frac{12800}{6 \times 6} = 355 \text{ MC/s.}$$

Indeed, Itaniums can actually perform 4 operations per cycle when we need to compute a product then an addition. This is not true in the FDTD algorithm where we essentially need to compute an addition then a product. This is why the algorithm can benefit from only half the Itanium's II amazing computing power.

Making the ratio between the number of cells that the processor can compute to the number of cells that memory can feed, we find that the compute power of the processor is used at $\frac{44}{355/2} \approx 25\%$ only: a four times less powerful processor would do the job as well, such as a monocore at 800 MHz. In double precision, a 400 MHz processor would make it...

From that point, we can take three decisions in order to increase our computing power:

- purchase slower processors that use less electricity, investing in a larger parallel machine with more compute nodes,
- give up the low order FDTD scheme and develop high order schemes such as Discontinuous Galerkin Method (refer to [15] and [19] for the mathematical framework and to [2] for the high order computing benefits shown in table 2 p. 754) that demand more operations per byte (when computing dense-block-matrix products on a Cartesian mesh),
- reconsider the FDTD implementation on machines with large enough data cache.

The first point (increasing the number of compute nodes) is investigated in sub-section 2.3 and tested in sub-section 2.4. On average size problems, it is worth making parallel computations in a row rather than sequential computations altogether at once.

The last point, which is the essence of this article, is discussed section 3 and tested section 4, focusing on techniques that reduce the memory bandwidth requirements through better using the cache than in the above standard FDTD implementation.

2.3. Data cache benefits to the FDTD technique. In the above introduction, we drastically simplified the memory to processor data access, assuming no cache hierarchy (or problem too large to take care of cache). Modern processors no longer possess tiny data caches. We can easily purchase processors with 2 MB data cache per core (shared or not). A 2 MB cache can handle a cubic domain made of

$$\left(\frac{2 \times 1024^2}{4 \times 6}\right)^{\frac{1}{3}} = 44$$

cells per direction in single precision (4 bytes per data, 6 fields per cell). Same formula applied to double precision gives 35 cells per direction. When problem is small enough to fit in processor's data cache, system's memory is no longer used and we actually benefit from the processor's increased computing power.

In order to be able to compute larger problems, we can increase the number of nodes (a way to increase the number of memory controllers to multiply the available bandwidth) so that the elementary problem on each node fits in cache.

Let us consider a cubic problem made of 352^3 cells. On only one node, data ($4 \times 6 \times \frac{352^3}{1024^2} = 998$ MB) does not fit in cache. Using the 44 MC/s memory limited speed with DDR2-800 RAM provided by relation 2.5, we need $\frac{352^3}{44} \times 10^{-3} = 991$ milliseconds per time step.

When using 512 nodes, data per node fits in cache ($\frac{352^3}{512} = 44^3$). In case the work between the nodes is well balanced and assuming a typical computing speed of 2400

MFlops per core (i.e. $\frac{2400}{6 \times 6} = 67$ MC/s), a time step requires $\frac{36 \times 44^3}{2400} \times 10^{-3} = 1.28$ milliseconds.

The limiting factor may become the network’s bandwidth for communicating the inter-domains fields. To parallelize an FDTD solver, one needs to provide 2 fields per face on all the interfaces. In a domain with 6 neighbours, there are $2 \times 6 \times 44^2 = 23232$ field values per time step to communicate, i.e. 91 kB per time step. On a 10 Gb/s network (point to point with full duplex), this requires around 70 microseconds assuming a perfect communication and computation overlap (since memory bandwidth is not used for computation).

So, on a perfect network as assumed above, computation time would be more than 768 times faster with 512 nodes: it would take 1.5 less time to make 512 parallel computations on 512 nodes the one after the other than to make 512 sequential computations at the same time.

2.4. Experimental parallel efficiency superior to one. Let us now deal with a real 320^3 problem spread among 512 processors (the number of cells is slightly lower to make sure to actually fit in cache). On the Tera 10 machine at the CEA’s supercomputing centre in Ile de France, CC-Numa nodes are made of four SMP blocks (called QBB from Bull) each with independent system bus, each block is made of two 1.6 GHz Itanium II dual core processors. We assume that communication times inside a node are negligible compared to inter-nodes communication times. In our example, network connections are to be performed on 32 nodes. Let the domain be split so that nodes deal with domains of size $40 \times (\frac{8}{2}, \frac{8}{4}, \frac{8}{4})$ i.e. (160, 80, 80) so that the inter-nodes communications are fairly minimized. This hypothesis can be enforced by an MPI Cartesian three-dimensional split, or by mixing shared memory programming (to be handled with care on a Non Uniform Memory Access node) with distributed memory programming. Figure 2.1 shows on a two-dimensional example how to map the do-

FIG. 2.1. *Minimizing network and NUMA communications: logically identify sub-domains to nodes, QBBs, processors and cores.*

System RAM Bus			D1	D2	D5	D6	D9	D10	D13	D14
Data Cache			D3	D4	D7	D8	D11	D12	D15	D16
QBB #2			D17	D18	D21	D22	D25	D26	D29	D30
Node #1 Network			D19	D20	D23	D24	D27	D28	D31	D32
QBB #3			D33	D34	D37					
QBB #4			D35	D36						
Core#1	Core#2								D61	D62
Proc: #1			D192						D63	D64

main (D) onto the Tera 10 hardware, minimizing inter-nodes communications first, then intra-nodes communications across the QBB crossbar interconnect, then intra-processors communications. In the figure, we put 4 domains per core to generalize the approach presented and further discussed in section 3.

Using single precision real fields, the number of bytes to communicate per time step amounts to

$$4 \times 2 \times (80^2 + 2 \times 80 \times 160) = 250 \text{ kB.}$$

The network is based on very low latency Quadrics Elan 4 cards, meaning we can assume a sustainable speed of 900 MB/s across all nodes. So, it seems realistic to assume we need

$$\frac{250}{900 \times 1024} \times 10^3 = 0.27$$

milliseconds per time step for the communications. At a peak computing speed of 67 MC/s per core (lower than the Itanium's II theoretical speed), we need

$$\frac{40^3}{67} \times 10^{3-6} \approx 1$$

milliseconds per time step for the per core computing time.

There, the parallel efficiency, defined as the time for a computation made by one core divided by the number of cores N times the time of the computation with the N cores is at least

$$\frac{340^3}{44} \times 10^{-3} \times \frac{1}{512 \times (1 + 0.27)} \approx 1.4$$

when the communication time is not overlapped by the computation time at all.

The reader may note that, to manage a computing centre, even though cores are usually dedicated to only one computation at a time, we may not reserve the complete processor to a single sequential application. Thus, in practice, when sequential FDTD computations are run simultaneously on a multicore processor, the memory bandwidth is divided by the number of simultaneous sequential computations.

Let us now confront our estimates to an experiment on the Tera 10 machine. Table 2.1 shows, on the example of a 320^3 cube, the performance that we actually

TABLE 2.1
Practical efficiency on Tera 10 machine, 1000 time steps.

Cores	Computations	CPU Time(s)	MC/s/core	MPI Wait(s)
1	16	2400	13.6	-
1	1	722	45.4	-
512	1	1.87	34.2	0.85

obtained with 32 nodes of 16 cores on Tera 10. First column indicates the number of cores used for the computation. Second column indicates the number of different computations performed on the associated nodes. First line stands for a standard use of the machine, where the sequential code runs alone on a reserved core, but the other 15 cores of the node are used for other numerical simulations. Available bandwidth is shared among 4 cores and actual performance is reduced by a factor 3.3 when comparing with second line where the full node is reserved to only one busy core. Last column in table 2.1 provides the MPI waiting time whereas the third column provides the total CPU time composed of computation and communication times.

The big disappointing result of this practical test is the sustained communication time that actually amounts to 3 times more time than expected. Another disappointment is that even though fields fit in cache, communications are not overlapped by computations.

The in cache computing speed is around 2400 MFlops. The out of cache speed is around the expected one of 44 MC/s when only one core is busy, around 11 MC/s

when all cores are busy. In this table, we have an apparent efficiency of 2.5 for the user who does not use a multicore machine as a monocore one. It takes two and a half less time to perform 512 parallel computations on 512 cores the one after the other than to make 512 sequential computations at the same time. It is then obvious to state that half the results will be brought back to the user within five times less time. This advocates that parallel computing can be energy efficient and very suitable to design optimization where parallelizing on fully independent problems is paradoxically not always the best technical solution.

3. Theoretical improvements. In this section, we present basic ideas to better use data in cache in order to reduce the stress on the memory bandwidth. We base our thoughts upon simplified hypotheses that are:

- processor's data cache to processor's registers throughput is infinite with no latency,
- system's RAM latency is fully hidden by prefetching performed by the compiler.

FIG. 3.1. *Simplified computer system model with infinite Cores to Cache Bandwidth*

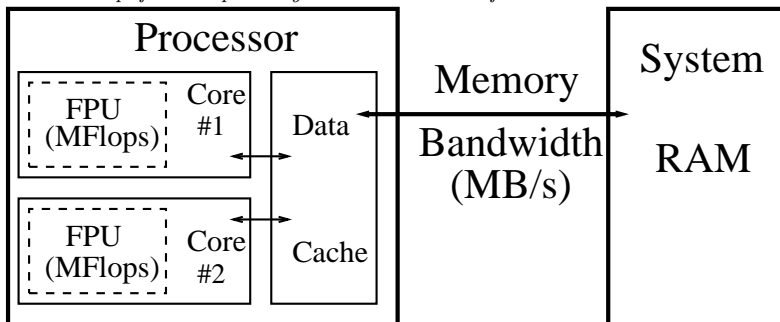

Figure 3.1 shows the simplified data flow and compute engine models that lie behind our theoretical performance analysis.

In section 3.1 we present the idea that consists in emulating the parallel operating mode in a sequential code, so that elementary sub-domains handled by the code fit in cache. Thus, the memory access can be viewed globally on every sub-domain instead of being performed (with the hypothesis of a very large simulation size) field by field, leading to a potential halving of the required memory bandwidth.

Section 3.2 further takes advantage of the sub-domains decomposition, overlapping the Ampere and Faraday solvers, computing the global update domain per domain the one after the other instead of solving the Ampere equation on all the domains, then solving the Faraday equation on all the domains. Potential gain is another 50%.

Under specific assumptions on the sub-domain's physics, we can further optimize the per domain solver, overlapping the electric and the magnetic fields update plane by plane as presented in section 3.3. This technique helps take advantage of the two first ones even when cache size is reduced.

Then, the final enhancement that consists in solving two or more time steps together per sub-domain is presented section 3.4. This idea originates to D. Orozco, PhD student of Pr. Guang R. Gao, University of Delaware. A potential doubling of the computation speed is expected. Do note that the first hypothesis no longer applies when memory bandwidth is optimized with this cache reuse algorithm; a finer analysis should consider the whole data access hierarchy.

3.1. Decomposing the problem into smaller problems as in parallel. As we saw section 2.4, parallel computations make the problem smaller per core and induce more cache hits.

So, our idea here is to split the problem into smaller problems, as done by domain decomposition solvers. Figure 3.2 shows an example where we split the computation

FIG. 3.2. *Decomposing the large computation domain into many small domains*

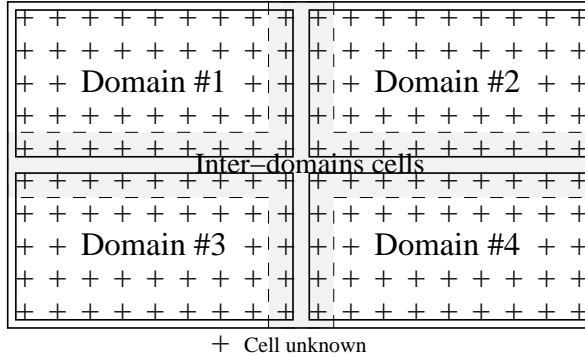

domain made of many cells into four domains, each with four times less cells. We may notice that this decomposition is similar to what can be naturally performed for parallel processing: introducing a domain split in a sequential code brings the same programming difficulties as the ones bound to parallelism. This is a great advantage for designing a parallel code: most of the bugs will be encountered in the sequential code where it is usually easier to detect and correct them.

In the FDTD method, the domain decomposition technique is not a numerical scheme but merely a modified implementation design with no impact at all on output values, such as loop tiling does. Operations performed to compute the fields are exactly the same, in the same order, it is only the order in which we compute the updated values which differs. This is a general feature for explicit solvers.

So, instead of making triple loops on the whole domain, we make triple loops in sub-domains, not forgetting to perform double loops at interfaces to complete the computation. This technique has already been used in [23] and [24].

Splitting the domain into sub-domains is done so that every sub-domain fits in cache, taking care of the actual available cache size for the multicore case in parallel.

The number of data accesses, when cache conflicts do not occur, is reduced to

$$2 \times \frac{3 + 3 + 3}{6} = 3 \tag{3.1}$$

per field update, instead of 6 as seen previously in relation 2.5 section 2.2. Let us explain that. For the electric field update, we need to load the magnetic field, the electric field, and then write the electric field. Without cache conflict, we may compute twice as many values inside domains as in the monolithic case, but there remains to compute the values at the interfaces of the domains. The extra-cost becomes negligible if the sub-domains size is large... which is not possible if the cache size is too small. In practice, a 2 MB data cache size is required to really improve performance.

If this article could be read by processors makers, let us ask them for more cache per core, not only more cores. In any case, we prefer more cache than higher clock frequencies.

3.2. Optimizing the leapfrog time scheme implementation. We may go further than merely splitting the problem into sub-domains. The FDTD time scheme is a leapfrog one where we solve the Maxwell-Ampere (2.1) then the Maxwell Faraday (2.2) equations as follows:

```
do d=1,ndomains
  call volAmpere(d) ! Computes the internal edges in domain d
enddo
call surfAmpere() ! Computes the edges at domains interfaces
do d=1,ndomains
  call volFaraday(d) ! Computes the internal faces in domain d
enddo
call surfFaraday() ! Computes the faces at domains interfaces
```

FIG. 3.3. Internal DoFs to a domain of the leapfrog time scheme

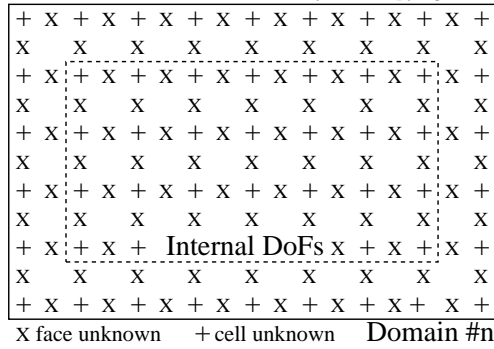

The improvement consists in solving Ampere and Faraday in a row using the internal degrees of freedom (DoFs):

```
do d=1,ndomains
  call volAmpere(d)
  call volFaraday(d) ! Internal faces that use internal edges only
enddo
call surfAmpere()
call surfFaraday() ! Adds computation at faces using edges on interfaces.
```

Figure 3.3 shows in a two-dimensional space the internal degrees of freedom that are updated with the modified time scheme: the electrical field is located at cells (“+”) and the magnetic field is located at faces (“x”). We no longer update the magnetic field values that need an electric value at the sub-domain’s boundary. This technique can be applied to the heat diffusion equation, not only to the waves equation.

With the inter-leaved scheme, assuming there is no cache conflict, we perform

$$2 \times \frac{3+3}{6} = 2 \tag{3.2}$$

memory accesses per field update: we load the electric and the magnetic fields, then we write them. This number is to be compared to the data access count of relation 3.1 section 3.1.

As compared with the initial standard FDTD implementation (relation 2.5 section 2.2), the computation speed we forecast is

$$\frac{6400}{4 \times 6 \times 2} = 133 \text{ MC/s.} \tag{3.3}$$

So, slightly altering the time scheme implementation, after decomposing the problem into sub-problems, leads to a theoretical 50% increase in computing efficiency. When designing a parallel code, this brings a strong impact on the code's architecture since no communication at all must be done between the Ampere and the Faraday updates on the contrary to what is generally performed such as in [25] or [12].

Making only one communication per time step can also be profitable to the code's parallel performance avoiding an inconvenient superfluous network latency.

3.3. Overlapping the leapfrog time scheme plane by plane. In an FDTD code, the basic vacuum equations may not be the only ones to solve between the electric field update and the magnetic field update. To take account of boundary conditions, for instance on a PEC (Perfectly Electric Conductor) we need to zero the electric field values on the PEC before entering the Faraday solver. In materials, we may need to take into account some recursive accumulators as in the JEC technique (see [5]) for linear dispersive media, we may need an absorbing boundary layer to emulate the infinite radiation condition (see [9]), or simply need to add a current to Ampere's equation. Materials and PML layers optimization is not dealt with in this article for the sake of conciseness, but basing the solver on one-dimensional geometrical coefficients as presented section 2.2 instead of easier to implement three-dimensional ones is essential not to increase the memory bandwidth stress.

We consider domains where there is nothing else to do but solve the Maxwell equations in vacuum. This assumption is not useless when the problem is split in many sub-domains, since there probably will exist many sub-domains where the assumption will be true. The reader may notice that this holds for a parallel code, but the gain shall be limited by the difficulty to make larger or smaller domains according to the associated processing speed. When using many sub-domains, even in a parallel computation, we may expect the load balancing to be naturally correct, especially if we layout the domains onto the processors using a balanced cost function.

So, in that vacuum case, the electric field and the magnetic field updates can be done plane by plane along with index k representing the z axis discretization. In the case of a 2 MB cache in single precision, this technique provides a good cache reuse for cubic domains of size up to

$$\left(\frac{2 \times 1024^2}{4 \times (3 + 3 + 3 + 3)} \right)^{\frac{1}{2}} = 209$$

cells per direction, which is far more than the value of 44 found in section 2.3. Moreover, this is independent of the z direction size.

The algorithm becomes:

```
do d=1,ndomains
  call planeAmpere(d,1)
  do k=2, nz
    call planeAmpere(d,k); call planeFaraday(d,k-1)
  enddo
  call planeFaraday(d,nz)
enddo
call surfAmpere(); call surfFaraday()
```

Of course, programming becomes rather more complicated than the one presented in Taflove's handbook [26]. This may become a drawback for the compiler's ability to perform optimizations. In particular, compiler-assisted cache replacement [13] may be less efficient.

3.4. Getting rid of the memory bandwidth bottleneck with limited cache stress. In vacuum, with the same assumption as in the above section, we may get rid of the memory bandwidth bottleneck using a very simple idea from Daniel Orozco [18].

Instead of performing the sub-domains updates step by step, we gather time steps. For the start, we use two steps as given by the following pseudo-code:

```

do n=1,ntimesteps/2
  ! Compute first and second time steps altogether inside domains:
  do d=1,ndomains
    call planeAmpere(d,1,nx,ny)
    call planeAmpere(d,2,nx,ny)
    call planeFaraday(d,1,nx,ny)
    ! Compute the internal DoFs by plane for two time steps in a row
    do k=3, nz
      call planeAmpere(d,k,nx,ny)
      call planeFaraday(d,k-1,nx,ny)
      call planeAmpere(d,k-1,nx-1,ny-1)
      call planeFaraday(d,k-2,nx-1,ny-1)
    enddo
    call planeFaraday(d,nz,nx,ny)
  enddo
  ! Terminate the first time step:
  call surfAmpere(); call surfFaraday()
  ! Terminate the missing volume computations for the second time step:
  do d=1,ndomains
    call surfAmpere(d,nx-1,ny-1,nz-1)
    call surfFaraday(d,nx-1,ny-1,nz-1)
  enddo
  ! Terminate the second time step:
  call surfAmpere(); call surfFaraday()
enddo

```

Figure 3.4 shows the very internal DoFs that are computed over two time steps every even time step and the intermediate internal DoFs that need be computed at every time step. These intermediate DoFs form a surface layer of one cell width next to the sub-domain’s boundary.

FIG. 3.4. Internal DoFs to a domain with the two steps cache reuse algorithm

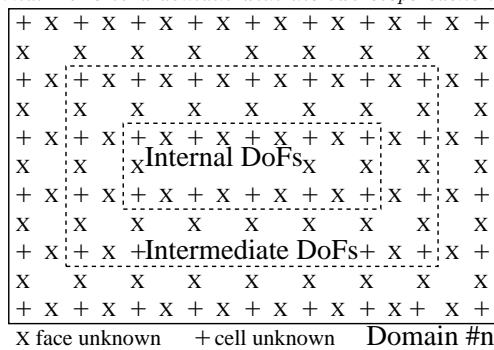

If we neglect the cost of terminating the computation for the internal DoFs of

the domains near the boundaries, we use half the memory bandwidth as long as the double plane problem fits in cache, thus for cubic domains of size up to

$$\left(\frac{2 \times 1024^2}{4 \times (3 \times 6)}\right)^{\frac{1}{2}} = 170$$

cells per direction.

Doing that, assuming there is no cache conflict, we need only one memory access per field update, theoretically doubling the speed of the FDTD code.

Theoretical performance due to memory bandwidth in case of cache fitting and under the assumption there is no cache conflict thus should reach:

$$\frac{6400}{4 \times 6 \times 1} = 267 \tag{3.4}$$

million cells per second. At this speed level, assuming cache to processor's throughput is infinite no longer holds.

The drawbacks of this technique are of course a very complicated programming which may limit the compiler's efficiency, but also merely outputting a field at a pin point becomes tricky to handle. So, instead of not performing this optimization, the right way to do when a pin point value is requested at a time step, is to avoid starting the two time steps the time step before the output is needed. When dealing with a computation over hundreds of thousands time steps, the user shall rarely ask for a print every time step.

4. Numerical experiments. We make numerical experiments benchmarking the various optimizations suggested section 3. Section 4.1 tests the kernel's speed on sub-domains, not taking the inter-domains over-cost into account. Section 4.2 presents two complete simulation tests and the obtained overall gains on the production's code Sophie that mixes up the different algorithms of section 3.

4.1. Experimental performance analysis. In this section, we analyze performance results in million cells computed per second (MC/s) obtained on an Intel Q6600 quadcore processor at 2.4 GHz with two 4 MB cache shared by pair. In mono-core mode, the available cache shall be 4 MB, in quadcore mode it will decrease down to 2 MB. In this article, we shall not discuss the effects of shared or dedicated cache.

The memory is made of four 2 GB DDR2-1066 dual channel modules. We investigate, for single or double precision, for monocore or quadcore being active, the performance variations along with the problem's size N , N being the equal number of cells per direction. Computer implementation is done in FORTRAN and compiled using "Intel 10.1.018 FORTRAN compiler for 64 bits applications".

The operating system is Mandriva Spring 2008.1 with Linux 64 bits kernel 2.6.24 and MPI is OpenMPI release 1.2.

Figure 4.1 indicates that performance per core in single precision is close to 2400 MFlops (67 MC/s), the theoretical performance peak of a 2.4 GHz Core 2 processor family. This performance is sustained oscillating around 1800 MFlops in single precision with only one core being busy. When all cores are busy, performance exceeds the 4×2400 MFlops peak processor's speed (267 MC/s), which is a measuring artefact. Performance drops for problems of size 44 as expected since data no longer fit in cache. When problem's size becomes larger and larger, the global performance of the four cores working altogether or only one core being active get closer and closer. This means that standard FDTD codes do not benefit from multicore, apart from the very

FIG. 4.1. Standard FDTD programming, multicore of limited interest

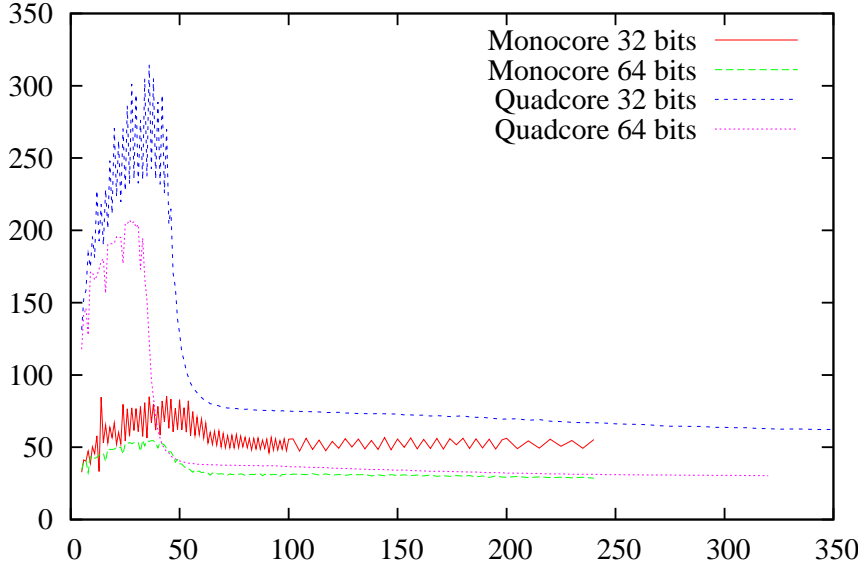

academic cases where the simulation domain is small enough to fit in the processor's data cache. In single precision computing, the asymptotic performance value for large domains drops down to below 62 MC/s (million cells per second). In double precision, the asymptotic value seems to be reached at around 30 MC/s. The theoretical value, on single precision code, is given by equation 2.5 for a 1066 MHz RAM:

$$\frac{1066}{800} \times \frac{6400}{4 \times 6 \times 6} = 59 \text{ MC/s.}$$

This is very close to the value provided by the numerical experiment.

Figure 4.2 shows the benefit of splitting the problem into sub-domains (section 3.1) using the modified time scheme (section 3.2). In this figure, instead of using one large problem of size N , we use 512 domains of size $N/8$ per axis. The figure indicates the global problem size N . The problem, as decomposed, fits in cache for very small sub-domains, so we start at $N = 48$. We observe that the multicore is now useful, bringing a doubling of the computation speed even for rather large problems. The optimal sub-domains size is around 27 in single precision and 22 in double precision to fully benefit from multicore. This value, lower than the expected value of 44 is probably due to cache conflicts. When using adequate sub-domains size, we get a throughput of around 120 MC/s (million cells per second) in single precision. This is twice the speed of the standard FDTD implementation, but when using equation 3.3 of section 3.2, we expect a throughput of

$$\frac{1066}{800} \times \frac{6400}{4 \times 6 \times 2} = 178 \text{ MC/s}$$

instead of 120. Instead of a factor 3 that could be theoretically expected, we only get a factor 2. In double precision, we get a speed at around 58 MC/s instead of 30 with the standard FDTD implementation. In the monocore mode, speed increases with the

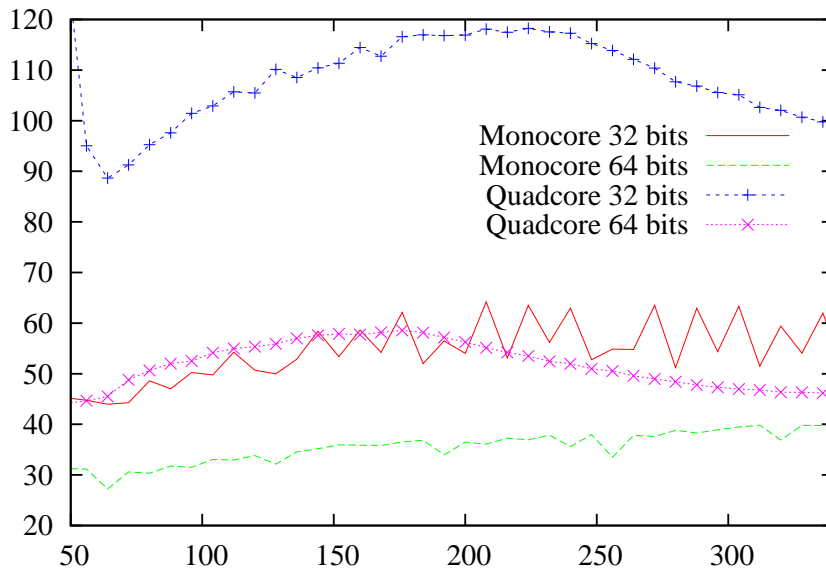
FIG. 4.2. *Splitting into sub-domains, multicore rather interesting*

problem's size up to 40 MC/s which shows that the data access pattern is improved. The double precision code speed is tightly controlled by the memory bandwidth and thus better benefits from this kind of loop tiling.

FIG. 4.3. *Plane solver on sub-domains, enlarging the range for multicore interest*

Figure 4.3 shows the interest of solving the Ampere and Faraday equations together plane by plane (section 3.3). This leads to less cache conflicts and performance

increases beyond sub-domains of size 50 in multicore. In monocore, performance is very stable. So, the interest of this technique is not to increase the computation speed related to the performance observed in the previous figure 4.2, but to make this performance sustainable on a larger domain size range, especially useful if the cache size per core were to decrease in the future with ever growing number of cores but not necessarily growing data cache size per core. Let us note that the compiler did a good job since the monocore 32 bits performance curve is maintained at the previous level of figure 4.2. The double precision monocore speed is lower than before, but not significantly.

FIG. 4.4. Cache reuse, quadcore two and a half as fast as monocore

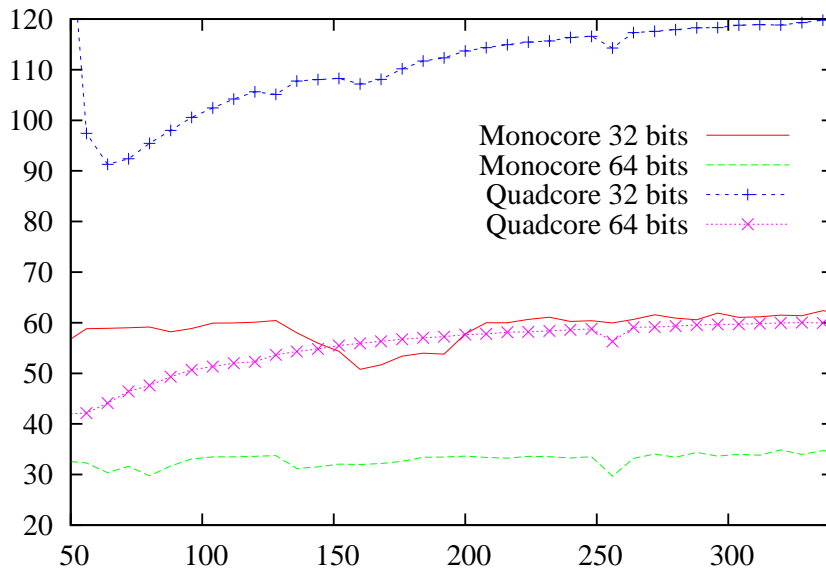
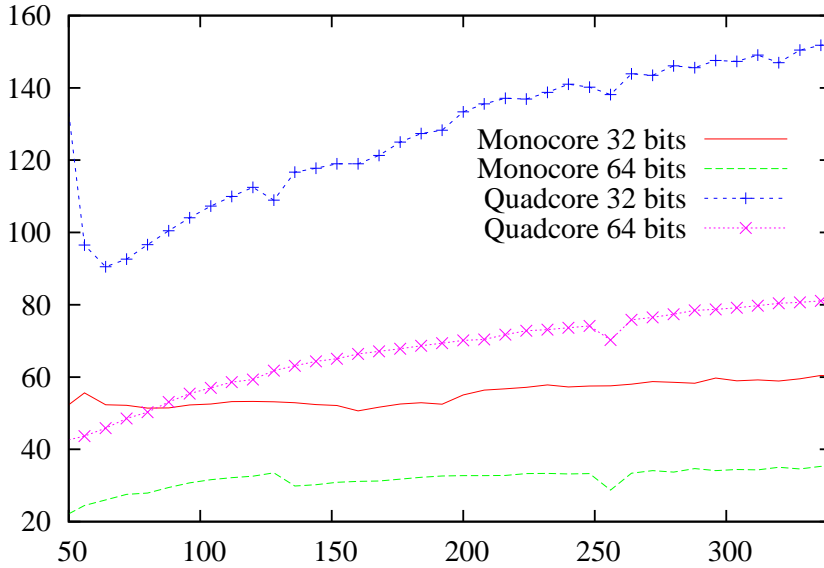

Figure 4.4 shows the tremendous advantage of the cache reusing technique solving two time steps at once (section 3.4). Multicore performance increases with the problem's size, optimal sub-domains size exceeding the value $N = 50$. We obtain a performance gain in multicore of more than two and a half as compared with the monocore performance, indicating that we are on the way to get rid of the memory bandwidth constraint. Nevertheless, in the monocore mode, this technique does not bring much benefit for small domains: the source code becomes difficult to optimize for the compiler and there is no benefit unless the bottleneck is actually the memory bandwidth. Performance on quadcore peaks at 160 MC/s in single precision and 80 MC/s in double precision. When using formula 3.4 with DDR2-1066, we ought to get a single precision speed of

$$\frac{1066}{800} \times \frac{6400}{4 \times 6 \times 1} = 355 \text{ MC/s}$$

which is more than twice the experimental speed of figure 4.4. But there, the limiting factor would no longer be the memory bandwidth, since the peak processor's performance, being four times 2400 MFlops, limits the computation throughput to a

maximum of

$$4 \times \frac{2400}{36} = 266 \text{ MC/s.}$$

Thus, the practical performance drops only by a 1.6 factor. This can be justified by cache conflicts and reduced code optimization due to compiler’s failure to perfectly optimize a much more complicated source code. Nevertheless, when comparing with the standard FDTD code of figure 4.1, we obtain a 2.7 gain in computation speed, both in double and in single precision. This explains why this article is entitled “getting rid of the memory bandwidth bottleneck” with an apparent equivalent bandwidth of

$$\frac{160}{59} \times 6400 \times \frac{1066}{800} = 22.5 \text{ GB/s.}$$

4.2. Global performance observed on real simulations using Sophie.

The Sophie code is a house made CEA/DAM software for electro-magnetics simulations solving Yee’s [30] or Yee’s dual scheme (inverting the locations of the fields between edges and faces) with an FDTD solver. The code’s first developments date back to mid 2005 and production’s first release dates back to end 2006. It is a general purpose solver that can model any linear dispersive medium (according to [5] with slight unpublished improvements), represent the infinite radiation condition (from [9] with an implementation that minimizes memory bandwidth’s demand), approximate thin layers by impedance conditions (following [20]), approximate thin wires (using Holland’s model [16] improved in [6]) and compute their coupling with simple electronic circuits. A basis for Sophie’s implementation is found in C. Guiffaut’s PhD Thesis [12] with further improvements orally provided by its author.

Sophie is a massively parallel code designed to run on thousands of multicore SMP nodes targeting tera-cells computations by the end of the decade on the Tera 100 machine. Sophie is made of 200 thousand lines of FORTRAN, most of them being related to the multi-domain feature initially brought in for both multi-physics load balancing and easier parallel debugging. A key feature for easing maintenance is that parallel and sequential runs provide exactly the same output, with no machine round-off difference. This tremendously helps eliminating the parallel bugs, making automatic non-regression parallel tests prove the code’s validity on a huge number of parallel configurations. Sophie is accompanied by an incredible ten thousand non-regression parallel tests that graph proof the code’s integrity.

For this article, we considered two cavity test cases:

1. a sphere included in a domain of size 402^3 with a diameter made of 400 cells,
2. a cubic domain of size 402^3 with no internal object.

In both cases, the problem amounts to around 64 million cells, and we perform 1300 time steps, i.e. 108% of the domain’s diagonal. We set a current at a pin point inside the sphere, we choose the same pin point for the cube. We also output 6 points at various positions every 20 time steps (not too often, in order not to stop the cache reuse algorithm too many times). We make various domain’s splits to see the impact on global performance.

Table 4.1, for double precision computation, shows for the sphere (S) and cube (C) cases the performance observed at the last time step in million cells per seconds (MC/s), as well as the total elapsed time in seconds (over all the time steps).

These numbers are not linearly deducible the one from the other except for the mono-domain case. In the case of sub-domains, we do not perform computations on sub-domains with all zeroed fields on their boundary as in the plane case of section

TABLE 4.1
Sophie production code's performance table, 64 bits.

Case	Split	Cores	MC/s	Time (s)	Vol. Time (s)	V/T %
S	1	1	27	3160	3160	100
S	1,2,2	4	30	2836	2836	100
S	A	1	38	1927	1303	72
S	A	4	58	1264	776	66
S	P2	4	58	1298	661	56
S	P3	4	37	2075	1063	57
S	P4	4	55	1314	919	75
S	P5	4	56	1296	877	73
C	1	1	27	3103	3103	100
C	1,2,2	4	30	2810	2810	100
C	A	1	31	2292	1668	77
C	A	4	59	1227	765	66
C	P2	4	49	1486	861	63
C	P3	4	37	2020	1011	54
C	P4	4	67	1082	702	71
C	P5	4	67	1080	683	69

3.3. This is a rather trivial optimization, which is particularly interesting at the beginning of the simulation. Do note that for the sphere case, if the sub-domains are small enough, there will always remain some domains entirely with zeroed fields.

After the total CPU time column, the following column in table 4.1 indicates the total CPU time spent in the sub-domains volume update routines. In multi-domain, a large part of the CPU time may be spent in the inter-domains routines `surfAmpere` and `surfFaraday` (as seen in section 3.2). Last column indicates, at the last time step, the percentage ratio of the time spent in the volume computations to the total CPU time.

Performance varies according to the number of cores we use, and, above all, according to the problem's split that is performed. The (1, 2, 2) split builds four domains cut in the y and z planes. The "A" split is the automatic split in (6, 16, 16) performed by the code, as a result of the study of the preceding section. The "P2" split is a manual dense split in (10, 24, 12). The "P3" split is a manual dense split in (2, 40, 20) that favours the x axis length, which is supposed to be good for vectorization and thus performance. The "P4" split is a manual standard symmetric split in (8, 8, 8). The "P5" split is a manual coarse split in (6, 12, 8).

Since the cache reuse technique cannot be performed on the sphere's PEC (Perfectly Electric Conductor) boundary, a coarse split limits the number of cells that are efficiently performed. Furthermore, too large domains are not suitable for fitting in cache. This is why the P5 split is not suitable for the sphere. The P3 split inhibits the cache reuse algorithm on all domains and is even worse.

Nevertheless, we have seen section 4.1 that larger domains are computed faster with the cache reusing technique. Thus, for the cube case where all sub-domains can benefit from that programming, we obtain a 2.3 times speed increase to the initial standard FDTD code in parallel. This follows the performance laws presented in section 4.1 for the inside volumes computations.

Table 4.2 is identical to table 4.1 for single precision computation. Same remarks

TABLE 4.2
Sophie production code's performance table, 32 bits.

Case	Split	Cores	MC/s	Time (s)	Vol. Time (s)	V/T %
S	1	1	43	1953	1953	100
S	1,2,2	4	62	1376	1376	100
S	A	1	61	1183	817	74
S	A	4	112	658	367	62
S	P2	4	102	724	342	51
S	P3	4	76	990	468	51
S	P4	4	105	694	450	72
S	P5	4	107	679	425	69
C	1	1	44	1905	1905	100
C	1,2,2	4	62	1358	1358	100
C	A	1	51	1376	1012	78
C	A	4	109	670	380	64
C	P2	4	85	852	456	60
C	P3	4	73	1023	503	54
C	P4	4	118	615	371	67
C	P5	4	120	602	364	67

can be made, with slightly smaller gains since the memory bandwidth is less the major limiting factor than in double precision. The performance is nevertheless nearly doubled.

5. Conclusion and outlooks. We have dealt with the performance bottleneck that limits the computing efficiency of FDTD codes. Using ideas borrowed to the computer scientists community (in particular discussing with D. Orozco), we have exhibited a technique to start getting rid with the memory constraint on multicore processors with large data caches. This technique has been implemented in a production code where it demonstrates a gain by a factor two on real applications.

A perspective to this cache reuse technique could be to gather more and more time steps together. The practical gain would decrease as a function of the sub-domains size, making high number of time steps gathering inefficient. For a limited number of time steps, say for instance 6, the difficulty (apart from programming the 6 elementary update functions) would be to manage the pin points prints and the fields images prints. For an industrial code that must be able to cope with 6 steps gathering as well as 2 (for smaller domains), mixing the steps would be difficult. In a multi-physics code, the interest might also be reduced.

Even though we limited ourselves to an FDTD code, this cache reuse technique can be applied to any low order solver on Cartesian meshes. It can also be applied to solvers based upon free meshes, despite it's efficiency shall be more limited by the available cache size since fields indirect addresses and sparse update matrix coefficients must also fit in cache, not only the fields values.

Last, but not least, conceiving applications keeping in mind the cache to RAM data transfers is suitable to general purpose GPU implementation where (from a high level software's architecture point of view) GPU's RAM plays the role of the processor's cache and where the limiting factor is the memory transfers to system's RAM through the PCI bus.

Acknowledgments. The author thanks Pierre Lalet, computer science engineer at CEA, for invaluable remarks and suggestions on this work.

REFERENCES

- [1] ULF ANDERSON, *Yee bench, a PDC benchmark code*, University of Stockholm, (2002).
- [2] M. BERNACKI, L. FEZOU, S. LANTERI, AND S. PIPERNO, *Parallel discontinuous Galerkin unstructured mesh solvers for the calculation of three-dimensional wave propagation problems*, Applied Mathematical Modelling, 30 (2006), pp. 744–763.
- [3] F. BODIN AND S. BIHAN, *Heterogeneous multicore parallel programming for graphics processing units*, Scientific Programming Journal, (to appear in).
- [4] M. CESSENAT, *Mathematical Methods in Electromagnetism*, vol. 41 of Series on Advances in Mathematics and Applied Sciences, World Scientific, 1996.
- [5] Q. CHEN, M. KATSURAI, AND P. AOYAGI, *An FDTD Formulation for dispersive media using a current density*, IEEE Transactions on Antennas and Propagation, 46 (1998), pp. 1739–1745.
- [6] FRANCIS COLLINO AND FLORENCE MILLOT, *Fils et méthodes d'éléments finis pour les équations de Maxwell. Le modèle de holland revisité.*, Tech. Report 3472, INRIA-Roquencourt, CERFACS, 42 avenue G. Coriolis, F-31057 Toulouse, August 1998.
- [7] C. DING, *Improving Effective Bandwidth through Compiler Enhancement of Global and Dynamic Cache Reuse*, PhD thesis, Rice University, Texas, 01 2000.
- [8] CHEN DING AND KEN KENNEDY, *The memory bandwidth bottleneck and its amelioration by a compiler*, in International Parallel and Distributed Processing Symposium, Cancun, Mexico, 05 2000.
- [9] S. GEDNEY, *Convolution PML (CPML): An efficient FDTD implementation of the CFS-PML for arbitrary media*, Microwave and Optical Technology Letters, 27 (2000), pp. 334–339.
- [10] STEPHEN D. GEDNEY AND J. ALAN RODEN, *Numerical stability of nonorthogonal FDTD methods*, IEEE Transactions on Antennas and Propagation, 48 (2000), pp. 231–239.
- [11] F. GUENTHER, M. MEHL, M. POEGL, AND C. ZENGER, *A cache-aware algorithm for PDEs on hierarchical data structures based on space-filling curves*, SIAM J. Sci. Computing, 28 (2006), pp. 1634–1650.
- [12] CHRISTOPHE GUIFFAUT, *Contribution à la méthode FDTD pour l'étude d'antennes et de la diffraction d'objets enfouis.*, PhD thesis, FRANCE/Université de Rennes I, Traitement du Signal et Télécommunications., 10 2000.
- [13] G. R. GAO H. YANG, R. GOVINDARAJAN AND Z. HU, *Compiler-assisted cache replacement: Problem formulation and performance evaluation*, in 16th International Workshop on Languages and Compilers for Parallel Computing, College Station, Texas, 10 2003, LCPC'03.
- [14] J. HARTMANN, A. KRAHNKE, AND C. ZENGER, *Cache efficient data structures and algorithms for adaptive multidimensional multilevel finite element solvers*, Applied Numerical Mathematics, 58 (2008), pp. 435–448.
- [15] J. S. HESTHAVEN AND T. WARBURTON, *Nodal high-order methods on unstructured grids - time-domain solution of Maxwell's equations*, Journal of Computational Physics, 181 (2002), pp. 186–221.
- [16] RICHARD HOLLAND AND LARRY SIMPSON, *Finite-difference analysis of emp coupling to thin struts and wires*, IEEE Transactions on Electromagnetic Compatibility, 23 (1981), pp. 88–97. Mission Research Corporation, Albuquerque USA.
- [17] R. MITTRA, WENHUA YU, YONGQUAN LU, AND RUI LU, *Gems - a general purpose conformal FDTD solver tailored for parallel platforms*, in Asia-Pacific Symposium on Electromagnetic Compatibility, 05 2008.
- [18] D. OROZCO, *Gathering time steps per domain in order to better reuse data in cache*. Private communication, 07 2008.
- [19] S. PIPERNO, M. REMAKI, AND L. FEZOU, *A non-diffusive finite volume scheme for the three-dimensional Maxwell's equations on unstructured meshes*, SIAM Journal, Numerical Analysis, 39 (2002), pp. 2089–2108. INRIA, Sophia Antipolis.
- [20] C. LE POTIER, *Le code Sumer-T, calcul d'électromagnétisme 3D temporel par une formulation volumes finis avec condition aux limites absorbante*, Tech. Report DO91, CEA, CEL-V, 1993.
- [21] HONGBO RONG, ALBAN DOUILLET, AND GUANG R. GAO, *Register allocation for software pipelined multi-dimensional loops*, in 2005 ACM SIGPLAN conference on Programming language design and implementation, Chicago, IL, USA, 2005, pp. 154–167.
- [22] S. RYOO, C. I. RODRIGUES, S. BAGHSORKHI, S. STONE, D. KIRK, AND W. HWU, *Optimization*

- principles and application performance evaluation of a multithreaded GPU using CUDA*, in 13th ACM SIGPLAN Symposium on Principles and practice of parallel programming, Salt Lake City, 2008.
- [23] D. SEIDEL, R. COATS, W. JOHNSON, M. KIEFER, P. MIX M., PASIK T. POINTON, J. QUINTENZ D., AND RILEY D. TURNER, *Quicksilver, a general tool for electromagnetic PIC simulation*, tech. report, Sandia National Laboratories, Albuquerque, New Mexico 87175, 1996.
- [24] D. SEIDEL, R. COATS, M. KIEFER, T. POINTON, AND J. QUINTENZ, *Quicksilver, a 3d, time-domain, finite-difference code for the electromagnetic simulation of complex structures*, Tech. Report DE92-003147, Sandia National Laboratories, Albuquerque, New Mexico 87175, 1992.
- [25] M. SU, D. BADER, I. EL-KADY, AND S.-Y. LIN, *A novel FDTD application featuring OpenMP-MPI hybrid parallelization*, in 2004 International Conference on Parallel Processing, ICPP04, 2004.
- [26] ALLEN TAFLOVE, *Computational Electrodynamics, The Finite-Difference Time-Domain Method*, Artech House Publishers, 1995.
- [27] L. VERDUCCI, P. PLACIDI, P. CIAMPOLINI, A. SCORZONI, AND L. ROSELLI, *A standard cell hardware implementation for finite-difference time domain (FDTD) calculation*, IEEE Transactions on Microwave Theory and Techniques, (2003).
- [28] WORKHOP ON GENERAL PROCESSING USING GPUS, *HMPP: A Hybrid Multi-core Parallel Programming Environment*, Boston, 10 2007.
- [29] HONGBO YANG, R. GOVINDARAJAN, G. GAO, AND ZIANG HU, *Improving power efficiency with compiler-assisted cache replacement*, Journal of Embedded Computing, 1 (2005), pp. 487–499.
- [30] KANE S. YEE, *Numerical solution of initial boundary value problems involving Maxwell's equations in isotropic media*, IEEE Transactions on Antennas and Propagation, 14 (1966), pp. 302–307.