

FIGURE CAPTIONS

All figures are to be printed in black & white.

SUPPLEMENTARY MATERIAL

Supplementary material content:

1/ Scheme of the experimental setup

Figure S1: Scheme of the experimental setup

2/ Comparison between correlation and experimental results for the mixtures studied but not displayed in the main text.

Figure S2: Correlation of the laminar burning velocity as a function of the equivalence ratio for: a) an ethane/air mixture; b) a propane/air mixture; c) a *n*-butane/air mixture. Solid squares: experimental data from this work; Solid line: correlation with parameters from this work.

Figure S3: Correlation of the laminar burning velocity as a function of the equivalence ratio for a methane-propane/air mixture. Points: experiments, lines: correlation.

Figure S4: Laminar burning velocities as a function of methane proportion relative to ethane for a methane-ethane/air mixture. Points: experiments, lines: modeling.

3/ Composition of the gases used in this study.

Table S1: Composition of the gases used in this study.

4/ Tables of experimental results.

Table S2: Detailed results obtained for laminar flame velocities of pure compounds (cm/s) and estimated error (sum of a systematic error and an error calculated from three experiments thanks to a Student statistic law with 97.5 confidence level).

Table S3: Detailed results obtained for laminar flame velocities of natural gas-like mixtures (cm/s) and estimated error (sum of a systematic error and an error calculated from three experiments thanks to a Student statistic law with 97.5 confidence level).

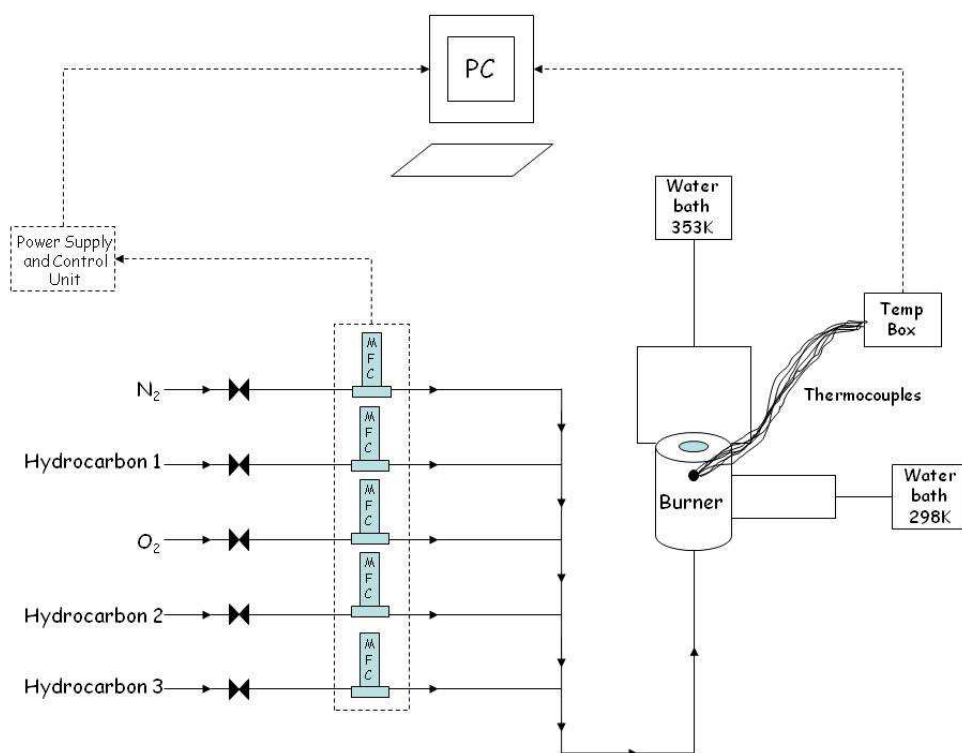
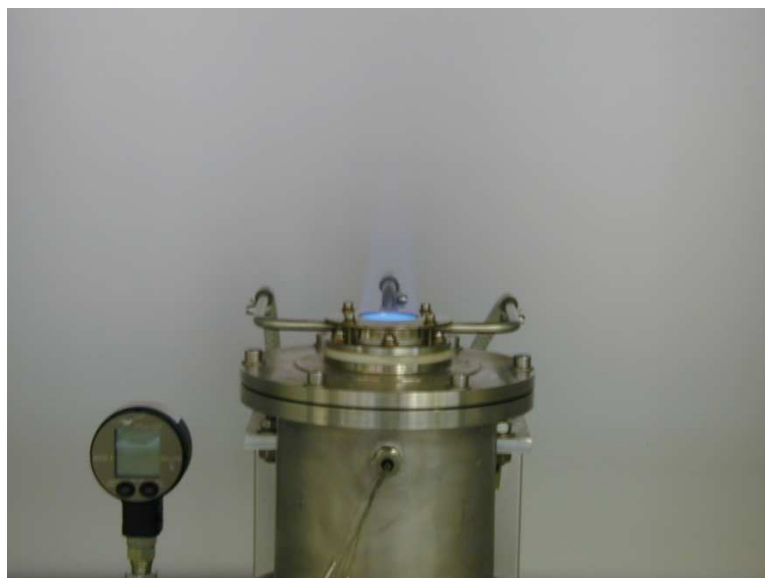

Figure S1: Photography and scheme of the experimental setup.

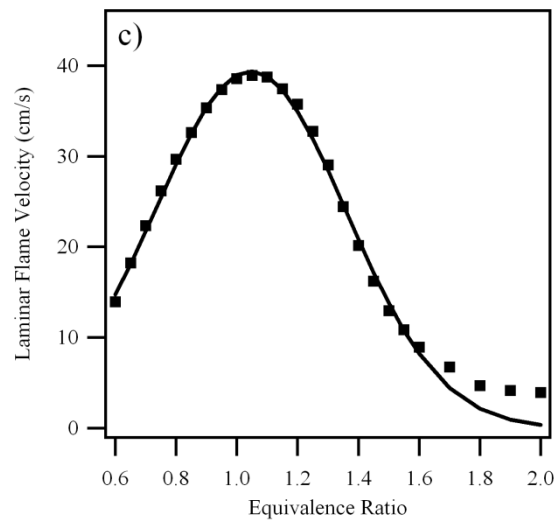
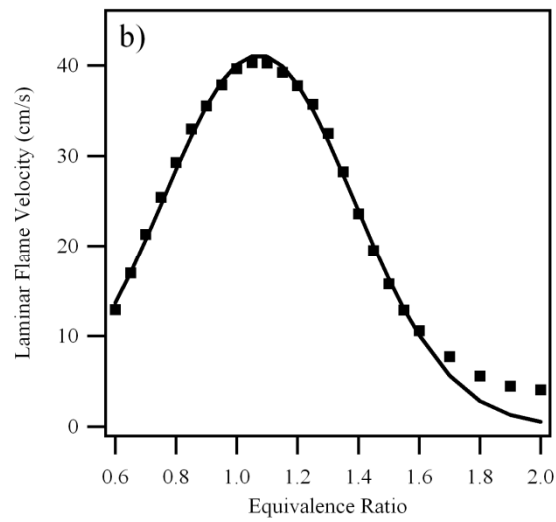
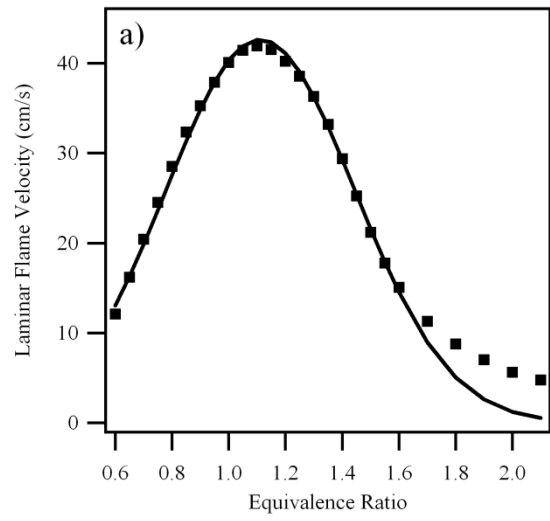

Figure S2: Correlation of the laminar burning velocity as a function of the equivalence ratio for: a) an ethane/air mixture; b) a propane/air mixture; c) a *n*-butane/air mixture. Solid squares: experimental data from this work; Solid line: correlation with parameters from this work.

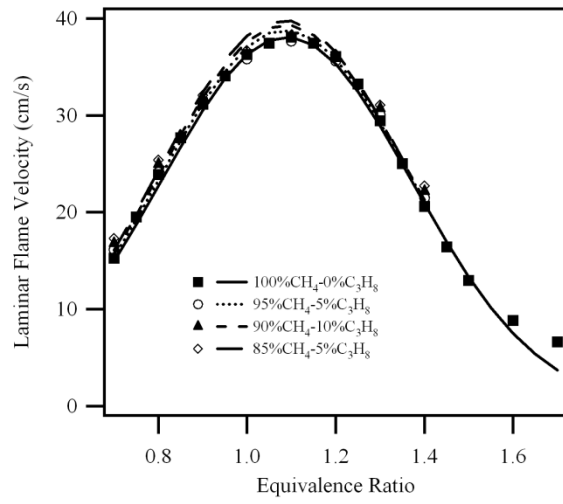

Figure S3: Correlation of the laminar burning velocity as a function of the equivalence ratio for a methane-propane/air mixture. Points: experiments, lines: correlation.

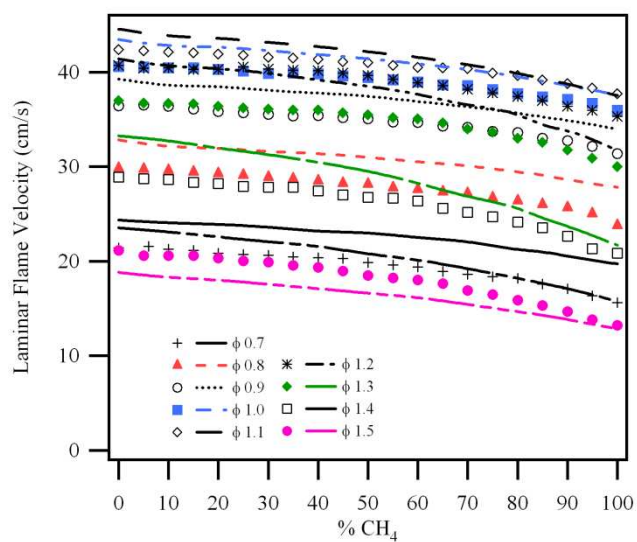

Figure S4: Laminar burning velocities as a function of methane proportion relative to ethane for a methane-ethane/air mixture. Points: experiments, lines: modeling.

Table S1: Composition of the gases used in this study.

Gas	Supplier	Grade	Purity, %	Contaminants
CH ₄	Messer	3.5	99.95	H ₂ O ≤ 5 ppmv, O ₂ ≤ 5 ppmv, CO+CO ₂ ≤ 10 ppmv, H ₂ ≤ 5 ppmv, N ₂ ≤ 100 ppmv, C _n H _m ≤ 100 ppmv
C ₂ H ₆	Messer	3.5	99.95	H ₂ O ≤ 5 ppmv, O ₂ ≤ 10 ppmv, CO ₂ ≤ 5 ppmv, N ₂ ≤ 40 ppmv, C _n H _m ≤ 400 ppmv
C ₃ H ₈	Air Liquide	3.5	99.95	H ₂ O ≤ 5 ppm-mol, O ₂ ≤ 10 ppm-mol, CO ₂ ≤ 5 ppm-mol, H ₂ ≤ 40 ppm-mol, N ₂ ≤ 5 ppm-mol, C ₃ H ₆ ≤ 200 ppm-mol, C _n H _m ≤ 200 ppm-mol
C ₄ H ₁₀	Messer	3.5	99.95	H ₂ O ≤ 3 ppmv, O ₂ ≤ 10 ppmv, N ₂ ≤ 40 ppmv, C _n H _m ≤ 500 ppmv
H ₂	Messer	5.0	99.999	H ₂ O ≤ 5 ppmv, O ₂ ≤ 1 ppmv, CO+CO ₂ ≤ 0.1 ppmv, N ₂ ≤ 5 ppm, C _n H _m ≤ 0.1 ppmv
O ₂	Messer	4.5	99.995	H ₂ O ≤ 5 ppmv, CO ≤ 0.5 ppmv, CO ₂ ≤ 0.5 ppmv, N ₂ ≤ 10 ppmv, Ar ≤ 10 ppmv, Kr + Xe ≤ 5 ppmv, CH ₄ ≤ 0.5 ppmv
N ₂	Messer	4.5	99.995	H ₂ O ≤ 5 ppmv, O ₂ ≤ 5 ppmv, total ≤ 50 ppmv

Table S2: Detailed results obtained for laminar flame velocities of pure compounds (cm/s) and estimated error (sum of a systematic error and an error calculated from three experiments thanks to a Student statistic law with 97.5 confidence level).

Equivalence Ratio ϕ	S_L (methane)	S_L (ethane)	S_L (propane)	S_L (n-butane)
0.60		12.1 ± 1.5	12.9 ± 1.0	13.9 ± 1.3
0.65		16.2 ± 1.7	17.0 ± 0.7	18.2 ± 1.1
0.70	15.3 ± 0.9	20.4 ± 2.2	21.3 ± 1.2	22.3 ± 1.7
0.75	19.5 ± 1.0	24.5 ± 2.3	25.4 ± 1.3	26.2 ± 1.5
0.80	23.9 ± 0.9	28.6 ± 2.2	29.3 ± 1.5	29.7 ± 1.1
0.85	27.7 ± 1.4	32.4 ± 1.7	33.0 ± 1.5	32.6 ± 1.0
0.90	31.2 ± 1.6	35.3 ± 1.8	35.5 ± 1.5	35.4 ± 1.4
0.95	34.1 ± 1.3	37.9 ± 1.6	37.8 ± 1.7	37.4 ± 1.7
1.00	36.3 ± 1.3	40.1 ± 2.2	39.6 ± 1.6	38.6 ± 1.5
1.05	37.5 ± 1.4	41.4 ± 1.7	40.3 ± 1.5	38.9 ± 1.6
1.10	38.1 ± 1.4	41.9 ± 1.5	40.3 ± 1.3	38.7 ± 1.1
1.15	37.5 ± 1.5	41.6 ± 1.4	39.2 ± 1.5	37.5 ± 1.5
1.20	36.1 ± 1.5	40.2 ± 1.1	37.7 ± 1.6	35.7 ± 1.8
1.25	33.2 ± 1.4	38.6 ± 1.4	35.7 ± 1.8	32.8 ± 1.1
1.30	29.4 ± 1.2	36.3 ± 1.2	32.5 ± 2.1	29.0 ± 1.3
1.35	25.0 ± 1.2	33.2 ± 1.4	28.2 ± 2.4	24.5 ± 1.0
1.40	20.6 ± 1.3	29.4 ± 1.4	23.6 ± 3.0	20.2 ± 0.8
1.45	16.4 ± 1.2	25.2 ± 1.6	19.5 ± 2.5	16.2 ± 0.9
1.50	13.0 ± 0.9	21.2 ± 0.7	15.8 ± 2.7	13.0 ± 0.8
1.55		17.8 ± 0.8	12.9 ± 1.6	10.9 ± 0.9
1.60	8.9 ± 0.6	15.1 ± 1.1	10.6 ± 2.0	8.9 ± 0.9
1.70	6.6 ± 0.8	11.3 ± 0.7	7.7 ± 1.4	6.8 ± 0.6
1.80		8.8 ± 0.8	5.6 ± 1.5	4.7 ± 0.6
1.90		7.0 ± 0.8	4.5 ± 0.7	4.2 ± 0.5
2.00		5.6 ± 1.0	4.1 ± 0.5	3.9 ± 0.6
2.10		4.8 ± 0.7		

Table S3: Detailed results obtained for laminar flame velocities of natural gas-like mixtures (cm/s) and estimated error (sum of a systematic error and an error calculated from three experiments thanks to a Student statistic law with 97.5 confidence level).

Equivalence Ratio ϕ	Pittsburgh	Abu Dhabi	Indonesia
0.70	17.6 ± 1.3	18.0 ± 2.0	17.3 ± 2.4
0.75	22.0 ± 1.0	22.0 ± 2.0	21.4 ± 2.4
0.80	25.8 ± 1.0	26.2 ± 2.0	25.4 ± 2.0
0.85	29.6 ± 1.0	29.7 ± 1.6	29.0 ± 2.2
0.90	32.8 ± 1.0	33.0 ± 1.4	32.5 ± 1.5
0.95	35.6 ± 1.3	35.8 ± 1.5	35.2 ± 1.8
1.00	37.5 ± 1.1	37.7 ± 1.4	37.2 ± 1.3
1.05	38.8 ± 1.1	39.2 ± 1.3	38.4 ± 1.8
1.10	39.4 ± 1.3	39.7 ± 1.3	39.0 ± 1.4
1.15	39.0 ± 1.5	39.4 ± 1.2	38.5 ± 1.4
1.20	37.6 ± 1.9	38.0 ± 1.1	37.0 ± 1.5
1.25	35.5 ± 1.3	35.7 ± 1.0	34.6 ± 2.5
1.30	31.8 ± 1.5	32.2 ± 1.7	30.7 ± 2.1
1.35	27.5 ± 1.8	27.9 ± 1.3	26.7 ± 2.4
1.40	22.8 ± 2.0	23.1 ± 1.3	21.8 ± 2.6
1.45	18.6 ± 1.8	19.1 ± 1.3	17.8 ± 2.4
1.50	14.7 ± 1.5	15.4 ± 1.0	14.0 ± 2.6
1.55	12.0 ± 1.7	12.1 ± 1.0	11.4 ± 2.0
1.60	9.8 ± 1.4	9.8 ± 1.0	9.5 ± 1.7
1.70	7.2 ± 1.1	7.3 ± 0.8	6.9 ± 1.5
1.80	5.6 ± 1.2	5.7 ± 0.8	5.5 ± 1.2