



**HAL**  
open science

## Sizing and dynamic analyses of a micro-grid supplying a harbor industrial area

Stephane Kreckelbergh, Ionel Vechiu

► **To cite this version:**

Stephane Kreckelbergh, Ionel Vechiu. Sizing and dynamic analyses of a micro-grid supplying a harbor industrial area. ICSTCC - System Theory, Control and Computing, Oct 2012, Sinaia, Romania. pp.7. hal-00772853

**HAL Id: hal-00772853**

**<https://hal.science/hal-00772853v1>**

Submitted on 11 Jan 2013

**HAL** is a multi-disciplinary open access archive for the deposit and dissemination of scientific research documents, whether they are published or not. The documents may come from teaching and research institutions in France or abroad, or from public or private research centers.

L'archive ouverte pluridisciplinaire **HAL**, est destinée au dépôt et à la diffusion de documents scientifiques de niveau recherche, publiés ou non, émanant des établissements d'enseignement et de recherche français ou étrangers, des laboratoires publics ou privés.

# Sizing and dynamic analyses of a micro-grid supplying a harbor industrial area

S. Kreckelbergh, I. Vechiu, *Member, IEEE*

**Abstract**—This paper presents the first results of the OptimaGRID project which focuses on the design of a micro-grid used for industrial area, namely the Tarnos area of the Bayonne harbor. The objective is to size the electrical sources of the micro-grid according with the harbor needs and test its dynamic operation. For these analyses, HOMER<sup>®</sup> and EUROSTAG<sup>®</sup> software have been used.

## I. INTRODUCTION

The micro-grid provides intelligence and the opportunity to manage and distribute energy, improving the scalability of the application, the reliability of the network, new applications and the ability for consumers to better manage costs, allowing to operate a real-time energy market.

Recently, the incorporation of renewable energy is changing the concept and meanings of service of electricity, with a trend towards decentralization in the generation and distribution. In this context, the objective of the OptimaGRID [1] project is to design, develop and implement intelligent control systems in micro-grids with high renewable energy penetration rate in order to facilitate real-time management in the industrial area. This project implies several laboratories located in Spain, Portugal and France.

This paper present an analyze study made by ESTIA laboratory in the framework of OptimaGRID project in order to size and investigate the dynamic operation of a micro-grid for the Tarnos area of the Bayonne harbor located in south-western of France.

## II. OBJECTIVES AND APPROACH

The first objective of the present work is to size the micro-grid according with the local renewable energy resources and the local needs. Once sized, the micro-grid has been dynamically investigated in simulation in order to analyze its behavior during different operation modes.

To size the micro-grid, the HOMER<sup>®</sup> computer model has been used to evaluate the design options for a grid-connected power system. HOMER<sup>®</sup>'s optimization and sensitivity analysis algorithms allow evaluating the economic and technical feasibility of a large number of technology options

and to account for uncertainty in technology costs and energy resource availability [2].

For a better understanding of the micro-grid dynamic behavior and stability the EUROSTAG<sup>®</sup> software has been use [3]. EUROSTAG<sup>®</sup> is used to analyze the stability margins and also to study the impact of the connection/disconnection of the renewable energy sources from the main grid.

## III. TARNOS HARBOR DESCRIPTION

Tarnos harbor area is composed of a 400 m dock-warehouse, an open area with a technical platform to supply the cranes, and a technical platform with two water pipes, one with freshwater to serve ships and one driven by a fire pump. Two railway tracks pass between the open area and the platforms and the material handling is provided by 4 cranes. The cranes supply comes from a HT 20kV station with a single EDF supplier. Three cranes operate at 5,5kV and another one at 20kV. All crane movements can be used simultaneously and are driven by nine induction motors. For each of these movements specific engines are used. In this particular case (Fig. 1), to rotate the turret of the crane that supports the arrow, the engine is a three-phase motor with a power of 22kW, an intensity of 43,5A and running at 1500 rpm.

The investigated harbor area is enlightened by 24 projectors of 1000W spotlights and 3 projectors of 500W. The energy consumption during 2009 was 95989 kWh.

## IV. DATA COLLECTION AND IMPLEMENTATION

At the level of the Tarnos harbor area different sensors have been installed using SEPAM 2000 system in order to recuperate data about power consumption and renewable resources.

### 1) Load profile

The Figure 2 shows the annual load profile of the Tarnos harbor. The load profile baseline data is a one-year time (2011) series representing the average electric demand, expressed in kW, for each time step of the year. It is a set of 24 hourly values of electric load, one for each hour of the day. The maximum and minimum of energy consumption is respectively of 3,2kW and 126,6kW (Table 1). Comparing the median, which is at 8,5kW and the maximum power

S. Kreckelbergh is with ESTIA - Technopole Izarbel - 64210 BIDART (corresponding author to provide phone: +33.5.59.43.54.72; fax: +33.5.59.43.84.05; e-mail: [s.kreckelbergh@estia.fr](mailto:s.kreckelbergh@estia.fr)).

I. Vechiu is with the ESTIA - Technopole Izarbel - 64210 BIDART (corresponding author to provide phone: +33.5.59.43.84.74; fax: +33.5.59.43.84.05; e-mail: [i.vechiu@estia.fr](mailto:i.vechiu@estia.fr)).

consumption, this confirms the load curve is crenellated (Fig. 2).

2) Wind data

In order to compute the output of the wind turbine in each time step, the available wind resources are needed. For the investigated area the wind resources in 2011 are shown in the Figure 3. This wind speed data comes from the CENER (National Renewable Energy Centre, Spain) simulation data and are evaluated for a height of 50 m compared to the sea level.

The Figure 4 shows monthly statistical data of the wind speed. The last column shows the data for the total of year.

As can be seen, the annual average of wind speed is about 5,3m/s with a max speed of 28m/s. Globally, the regimes of wind are more powerful for the winter and lower for the summer. For example the maximal daily averages in November-February exceed 10m/s, while in July-August is less than 7m/s.

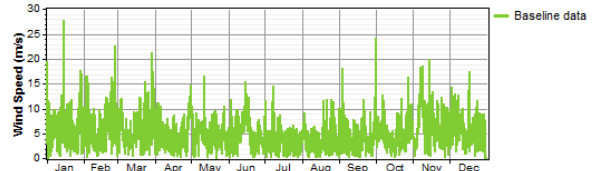

Figure 3. Wind resources available on Tarnos (2011)

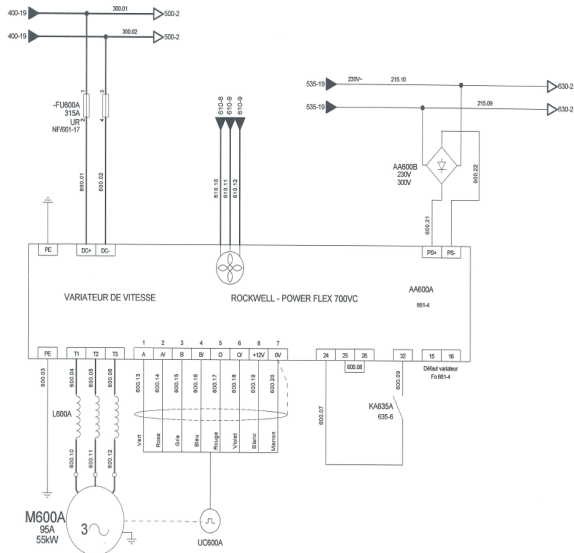

Figure 1. Electrical schema for orientation of a crane

Table 1: Load energy consumption statistic elements

Load power consumption (kW)	
Minimum	3.2
Maximum	126.6
Mean	17.6
Standard deviation	20.2

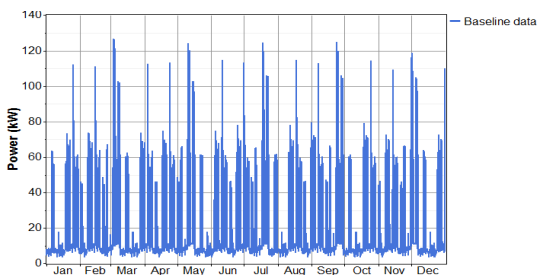

Figure 2. Annual (2011) load profile

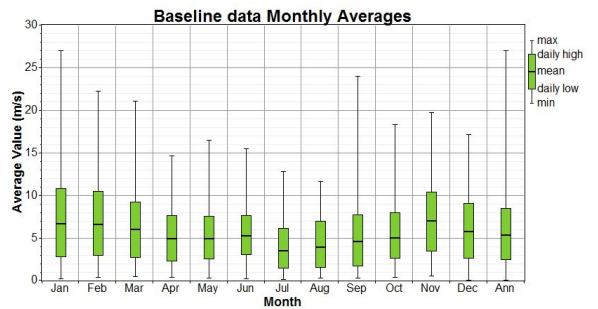

Figure 4. Monthly data of the wind speed (2011)

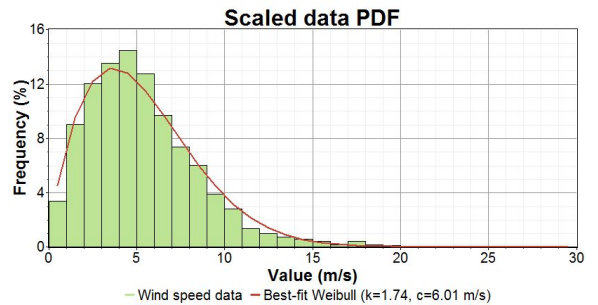

Figure 5. PDF (Probability Density Function) of data of wind speed

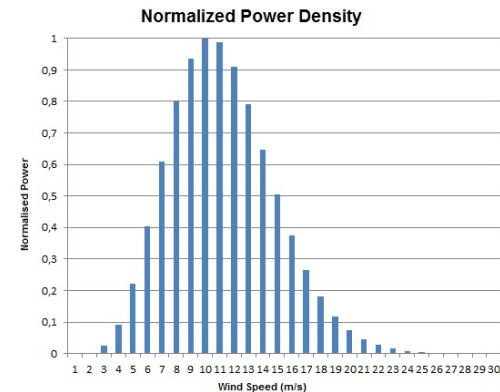

Figure 6. Normalized Power Density

The Figure 5 shows the Probability Density Function (PDF) of the estimated wind speed on the harbor site. We can see that the probability to have a wind speed between 4 and

5m/s is more than 14%. The probability of a wind speed between 6 and 7m/s is almost 10%. For the others wind speeds the probability decrease significantly. Weibull fit parameters allow us to compute the Normalised Power Density (Fig. 6) that permits to know the power density for each wind speed. As can be seen the maximum power density is obtained for a wind speed of 10m/s.

The main conclusions concerning the wind resources analyses are:

- for the Tarnos site, the annual average wind speed at 50 m height compared with the sea level is 5,3m/s;
- the wind is more powerful in winter than during the summer.

This resource is complementary with the electric consumption in the harbor, which is more important in winter.

### 3) Solar data

In order to compute the output of the PV panels of each time step, the available solar resources are needed. The data of solar irradiation are obtained from AICIA (Andalusian Association for Research and Industrial Cooperation, Spain) situated in Seville, and concerns the harbor of Bayonne (Fig. 7). The Figure 8 illustrates monthly statistical data of the solar irradiation (nocturnal and diurnal data). The average the data are expressed for every month of the year, and also for all the year (last column).

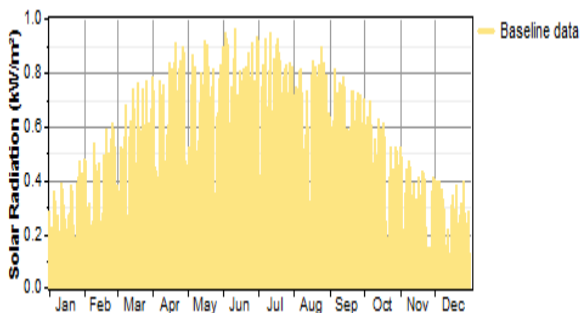

Figure 7. Solar resources available on Tarnos area (2011)

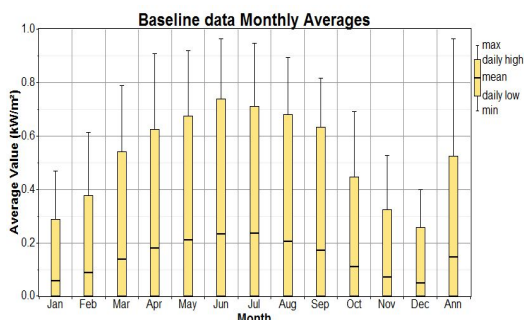

Figure 8. Monthly data of solar irradiation

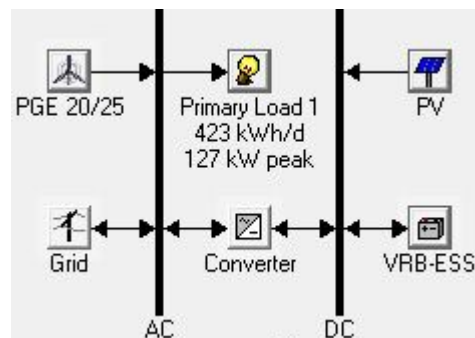

Figure 9. Harbor micro-grid architecture

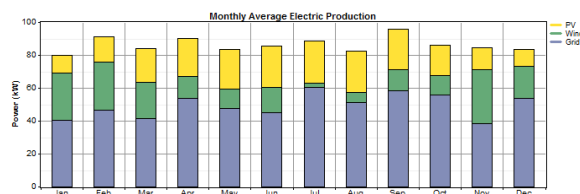

Figure 10. The monthly average electric production Harbor

Compared with the wind speed, the solar irradiation is more important during the summer. These resources are complementary compared with the wind resources.

For the solar resources, the mean conclusions are:

- the annual average solar radiation is  $0,15\text{kW/m}^2$ ;
- the solar potential is more important in summer than in winter. This resource is complementary compared with the wind potential;
- the solar irradiation has important daily variations, which have to be taken into account in order to well define the micro-grid control.

### 4) Micro-grid architecture

The renewable resources and the consumption data presented before have been used as input data for HOMER<sup>®</sup> software to size the micro-grid components. For example, the information concerning the site wind density power (Fig. 6) is used to choose the wind turbine, with an optimized power curve. This strategy implies also the selection of AC or DC components.

The harbor contains different electrical equipments connected to the grid. For this study a basic architecture was taken into account. The micro-grid architecture is based on 150 kW PV array, two wind turbines PGE 20/25 [4] a storage redox battery of 200 kW/800 kWh and an inverter of 400 kW (Fig. 9).

With the configuration shown in Figure 9, the component energy production fractions are: the PV array 346,478 (39%), the wind turbines 149,397 (17%), the grid purchases 403,538 (45%), for a total of 899,412 (kWh/year). The monthly average electric production of the investigated micro-grid architecture connected to the main grid is illustrated in Figure 10.

## B. Dynamic study

The study is done as a top-down process. Indeed, the first part of the article has permitted to size micro-grid components. The following part presents the dynamical study of this micro-grid [4].

The configuration of the micro-grid illustrated in Figure 9 was implemented using EUROSTAG<sup>®</sup>, the software for dynamic operation investigation and the main electrical scheme of the Tarnos harbor area is shown in Figure 11.

The Figure 12 shows the real load profile of the crane 12. As can be seen in Figure 13, using the EUROSTAG<sup>®</sup> micro-grid dynamic model, it is possible to approximate in simulation the real load profile of the crane 12.

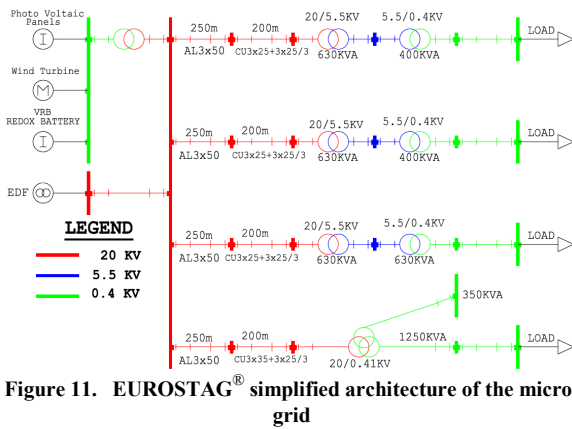

Figure 11. EUROSTAG<sup>®</sup> simplified architecture of the micro-grid

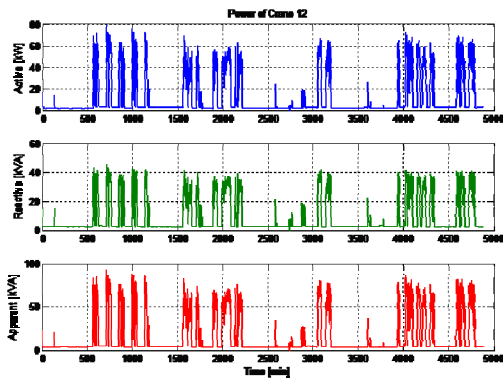

Figure 12. Load profile of the crane 12

Many simulations have been conducted in order to validate the dynamic model of the micro-grid. Figure 14 shows the operation of the micro-grid according with the solar irradiation variation and load demand. At  $t=60s$ , when the solar irradiation level increases from 0 to  $500 \text{ W/m}^2$ , the power of the PV system rises from 0 to 0.16 MW. At  $t=120s$ , another solar irradiation step (from 500 to  $1000 \text{ W/m}^2$ ) is applied to the PV system input and the output power increases to the rated value (0.32 MW). As it can be seen, as soon as the solar irradiation increases, almost half of the total active power requested by cranes 12 and 13 (around 0.65 MW) will be supplied locally by the PV system. Consequently, the

power requested from the main grid will decrease proportionally.

The same tests have been run varying the wind speed in the input of the wind turbine and the results are illustrated in Figure 15. The step wind speed applied varies between 12.5 and 15 m/s, with an intermediary value of 10 m/s. As for the PV system, the power absorbed from the main grid in order to supply the power requested by cranes 12 and 13 will decrease according with the power produced by the wind turbine.

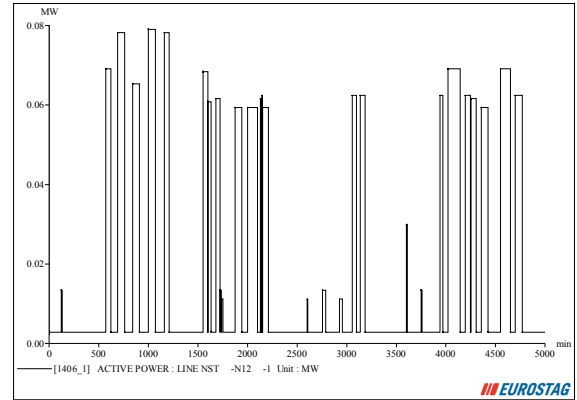

Figure 13. EUROSTAG<sup>®</sup> simulation load profile of the crane 12

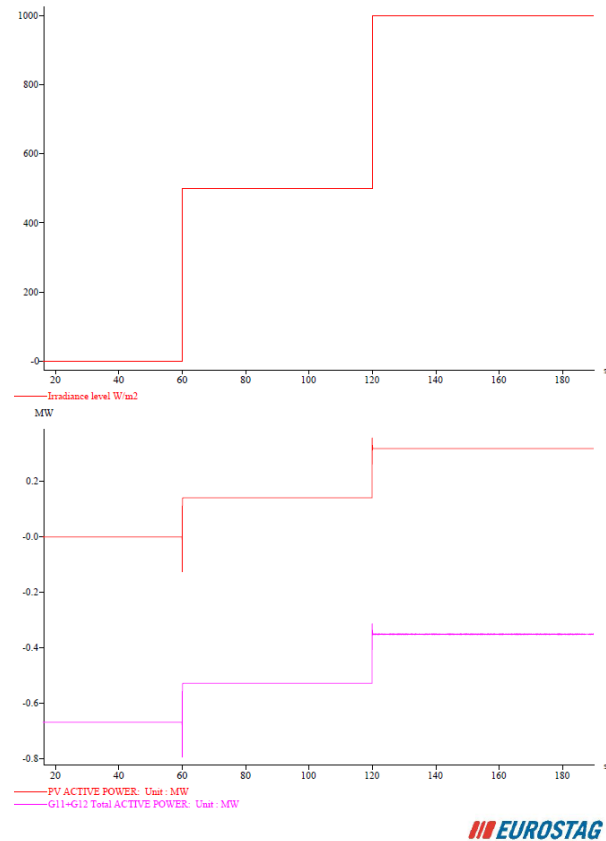
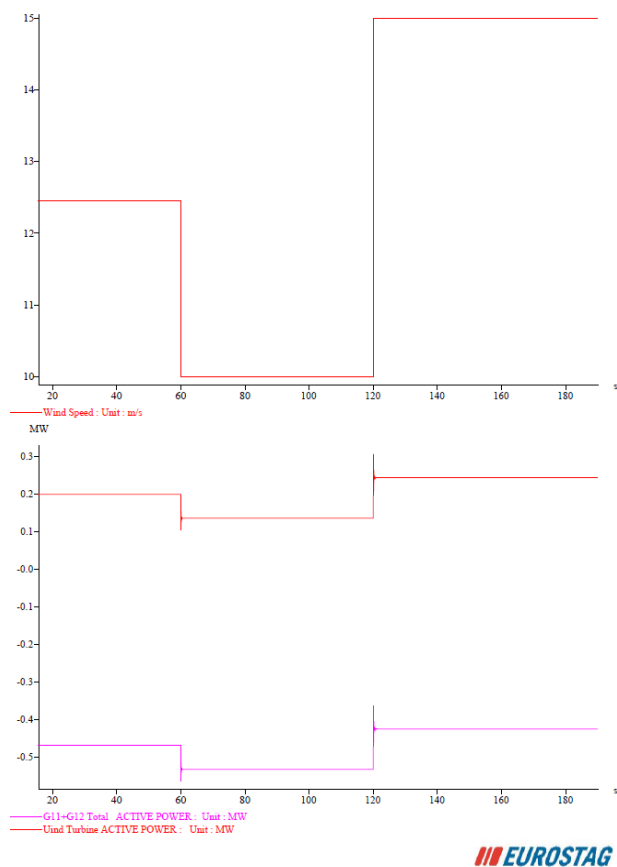

Figure 14. Solar Irradiation, PV active power and total active power demand



**Figure 15. Wind speed, Wind Turbine active power and total active power demand**

## V. CONCLUSION

In this paper, the first stage of a study made to design and investigate the dynamic operation of a micro-grid for an industrial harbor area has been presented. For an optimal sizing and operational strategy of the micro-grid, the software used in this analysis was the Hybrid Optimization Model for Electric Renewable (HOMER®). A sensitivity analysis was also performed to obtain the optimal configuration of hybrid renewable energy based on different combinations of the generating system. Then, the operation of the obtained architecture was dynamically investigated using EUROSTAG® software. The first simulation results showed the accuracy and validate the micro-grid dynamic model. In future works, different simulation case studies will be investigated using the dynamic model in order to analyze the micro-grid stability.

## ACKNOWLEDGMENTS

The authors acknowledge SUDOE for supporting the OptimaGRID Project, as well as the Bayonne harbor and the project partners for data availability.

## REFERENCES

- [1] <http://www.optimagrid.eu>.
- [2] Lambert T, Gilman P, Lilienthal P, *Micropower system modeling with HOMER*, "Integration of Alternative Sources of Energy", Farret FA, Simões MG, John Wiley & Sons, December 2005, ISBN 0471712329.
- [3] Verotte J.F., Panciatici P., Meyer B., Antoine J.P., Deuse J., and Stubbe M., "High Fidelity Simulation Power System Dynamics", IEEE computer Applications in Power, January 1995.
- [4] <http://www.icrepq.com/icrepq'12/230-surianu.pdf>
- [5] Delille, G., François, B. and Malarange, "Dynamic frequency control support: A virtual inertia provided by distributed energy storage to isolated power systems", Innovative Smart Grid Technologies Conference Europe (ISGT Europe), 2010 IEEE PES.