



HAL
open science

Combinatorial rigidity of arc complexes

Valentina Disarlo

► **To cite this version:**

| Valentina Disarlo. Combinatorial rigidity of arc complexes. 2012. hal-00771195v1

HAL Id: hal-00771195

<https://hal.science/hal-00771195v1>

Preprint submitted on 8 Jan 2013 (v1), last revised 27 May 2015 (v4)

HAL is a multi-disciplinary open access archive for the deposit and dissemination of scientific research documents, whether they are published or not. The documents may come from teaching and research institutions in France or abroad, or from public or private research centers.

L'archive ouverte pluridisciplinaire **HAL**, est destinée au dépôt et à la diffusion de documents scientifiques de niveau recherche, publiés ou non, émanant des établissements d'enseignement et de recherche français ou étrangers, des laboratoires publics ou privés.

COMBINATORIAL RIGIDITY OF ARC COMPLEXES

VALENTINA DISARLO

ABSTRACT. We prove that every automorphism of the arc complex of a compact orientable surface with marked points in the interior and on the boundary is induced by an homeomorphism of the surface which fixes the marked points set wise. Our proof is based on a combinatorial approach which leads some new information on the geometry of these objects and is independent by all the other well-known combinatorial rigidity results.

CONTENTS

1. Introduction	1
1.1. Structure of the paper	2
2. Combinatorics of the arc complexes	2
2.1. Arc complexes $A(S, \mathbf{p})$	3
2.2. Intersection numbers	4
2.3. Invariance lemmas and proof of Theorem C	5
3. Basic cases	9
3.1. Genus 0	10
3.2. Case $b = 1$	12
4. Proof of Theorem A	19
5. Proof of Theorem B	20
References	22

1. INTRODUCTION

Combinatorics of arcs play a key-role in the study of the moduli space of Riemann surfaces. In [3] Harer introduced the arc complex of a punctured surface as a tool to understand the homology of the mapping class group. In [1] and [14] Bowditch-Epstein and Penner showed that appropriate quotients of the arc complex give a combinatorial compactification of the moduli space of punctured hyperbolic surfaces.

In this paper we deal with arc complexes in the most general setting of surfaces with boundary, marked points on the boundary and in the interior. These arc complexes naturally arise from Harer's ones when passing to links of simplices. For instance, the link of a vertex in Harer's arc complex is a join of arc complexes in our fashion. This general setting was first introduced by Penner in his decorated Teichmüller theory for surfaces with boundary ([13], [15]). In [11] he suggested an approach to mapping class groups and moduli spaces problems through the combinatorics of arcs and in [12, 14] he studied some properties of the topology of quotients of these more general arc complexes.

In this paper we study the problem of combinatorial rigidity of arc complexes for surfaces with boundary, marked points on the boundary and in the interior. Similar results of combinatorial rigidity for curve complexes were first stated by Ivanov ([8]), then proved in low genus by Korkmaz [6] and proved in the general case by Luo [9]. Applications concern a new proof of Royden's theorem for the isometries of the Teichmüller space and some new the properties of finite index subgroups of the mapping class groups (see for instance [8, 7]). Through (non-trivial) reductions to curve complexes automorphism, one can study the rigidity of other combinatorial complexes naturally associated to a surface (a survey can be found in [10]).

In the case of arc complexes we prove what follows:

Theorem A. *Let $(S_{g,b}^s, \mathbf{p})$ be an orientable surface of genus g with b boundary components, s punctures and $\mathbf{p} = (\mathbf{p}_i)_{i=1}^b$ with $p_i \geq 1$ for all $i = 1, \dots, b$, whenever $b \geq 1$.*

If $(S_{g,b}^s, \mathbf{p}) \neq (S_{0,2}^0, (1, 1))$, then $A(S_{g,b}^s, \mathbf{p})$ is rigid. Moreover, the natural homomorphism $\text{MCG}(S_{0,2}^0, (1, 1)) \rightarrow \text{Aut}A(S_{0,2}^0, (1, 1))$ is surjective, but not injective.

Theorem B. *Let $(S_{g,b}^s, \mathbf{p})$ be an orientable surface of genus g with $b \geq 1$ boundary components, s punctures and $p_i \geq 1$ for all $i = 1, \dots, b$.*

If $(S_{g,b}^s, \mathbf{p}) \neq (S_{0,2}^0, (1, 1))$, then $A_{\#}(S_{g,b}^s, \mathbf{p})$ is rigid. Moreover, the natural homomorphism $\text{MCG}(S_{0,2}^0, (1, 1)) \rightarrow \text{Aut}A_{\#}(S_{0,2}^0, (1, 1))$ is surjective, but not injective.

Theorem C. *If $A(S_{g,b}^s, \mathbf{p})$ is non empty and isomorphic to $A(S_{g',b'}^{s'}, \mathbf{p}')$, then $s = s'$, $b = b'$ and $p_i = p'_i$ for all i .*

As a corollary of the first theorem we also recover a theorem of Irmak-McCarthy [?] concerning the rigidity of Harer's original arc complex.

Our proof is based on a combinatorial approach, which leads to new information on the geometry of our complexes, and it is independent from all the other results of combinatorial rigidity previously achieved, included the rigidity of the curve complex.

1.1. Structure of the paper. The structure of the paper is the following. In Section 2 we introduce the notations and we discuss about the combinatorics of the arc complexes. Here we prove several Invariance Lemmas which will be used throughout the paper, and we also prove Theorem C. In Section 3 we discuss examples and give a proof of Theorem A in the two basic cases: the genus 0 case and the one boundary component case. In Section 4 we complete the proof of Theorem A in full generality. Section 5 is devoted to the proof of Theorem B.

2. COMBINATORICS OF THE ARC COMPLEXES

Let us first fix the notation. Let $S = S_{g,b}^s$ be a compact orientable surface with genus $g \geq 0$, $b > 0$ ordered boundary components and s distinguished points in the interior of the surface. We shall fix a finite set \mathcal{P} of distinguished points on ∂S and denote by $\mathbf{p} = (p_1, \dots, p_b)$ the vector whose component p_i is the number of distinguished points on the i -th boundary component of S . Finally we denote by $(S_{g,b}^s, \mathbf{p})$ or (S, \mathbf{p}) (when no ambiguity occurs) the pair given by a surface $S_{g,b}^s$ and a vector \mathbf{p} of distinguished points on its boundary as here described.

We shall now recall the definition of mapping class group of the pair (S, \mathbf{p}) . Let \mathcal{S} be the set of the s distinguished points in the interior of S . Let $\text{Homeo}(S, \mathbf{p})$ be the group of the homeomorphisms of S fixing $\mathcal{P} \cup \mathcal{S}$ as a set. Let $\text{Homeo}_0(S, \mathbf{p}) \subseteq \text{Homeo}(S, \mathbf{p})$ be the normal subgroup of the homeomorphisms isotopic to the identity. The *mapping class group of the pair* (S, \mathbf{p}) is the group $\text{MCG}^*(S, \mathbf{p}) = \text{Homeo}(S, \mathbf{p}) / \text{Homeo}_0(S, \mathbf{p})$. The *pure mapping class group of the pair* (S, \mathbf{p}) is the subgroup $\text{PMCG}^*(S, \mathbf{p}) < \text{MCG}^*(S, \mathbf{p})$ generated by the homeomorphisms fixing $\mathcal{S} \cup \mathcal{P}$ pointwise.

Let \mathcal{B}_i be the i -th boundary component of S with p_i marked points on it. We will introduce here the definition of $\frac{2\pi}{p_i}$ -rotation around \mathcal{B}_i .

First consider the annulus $A = S^1 \times [0, 1]$ in \mathbb{R}^2 (equipped with polar coordinates) with the marked points $\{(\frac{2\pi}{p_i}j, 1)\}_{j=0, \dots, p_i-1}$ in the (θ, r) -plane with the orientation induced by the standard orientation of the plane. The $\frac{2\pi}{p_i}$ -rotation map of A is the map $R : A \rightarrow A$ defined as $R(\theta, r) = (\theta + \frac{2\pi}{p_i}t, t)$. Remark that R is orientation preserving, the restriction $R_{\mid} : S^1 \times \{1\} \rightarrow S^1 \times \{1\}$ is a rotation of angle $\frac{2\pi}{p_i}$, the restriction $R_{\mid} : S^1 \times \{0\} \rightarrow S^1 \times \{0\}$ is the identity and the power R^{p_i} is the right Dehn-twist around the core curve of the annulus.

Let $\{P_j\}_{j=0,\dots,p_i-1}$ be the set of its marked points on \mathcal{B}_i . Let N be the closure of a regular neighborhood of \mathcal{B}_i , and choose a homeomorphism $\phi : N \rightarrow A$ such that $\phi(P_j) = (\frac{2\pi j}{p_i}, 1)$ for all $j = 0, \dots, p_i - 1$. We consider the homeomorphism $\tilde{R}_i : (S, \mathbf{p}) \rightarrow (S, \mathbf{p})$ defined as follows:

$$\tilde{R}_i(x) = \begin{cases} \phi^{-1} \circ R \circ \phi(x) & \text{for } x \in N \\ x & \text{for } x \in S \setminus N \end{cases}$$

The map \tilde{R}_i depends on the choice of ϕ and N , but the equivalence class modulo isotopies which fix \mathcal{P} pointwise doesn't depend on such choices and gives a well-defined non-trivial element $\rho_{\frac{2\pi}{p_i}} = [\tilde{R}_i]$ in $\text{MCG}^*(S, \mathbf{p})$. We call such element the $\rho_{\frac{2\pi}{p_i}}$ -rotation around the i -th boundary component \mathcal{B}_i .

We remark that the group $R_{\mathbf{p}} = \langle \rho_{\frac{2\pi}{p_0}}, \dots, \rho_{\frac{2\pi}{p_b}} \rangle$, generated by all the rotations around the boundary components of S is abelian of rank b .

We have a Birman-like exact sequence:

Proposition 2.1. *Let Σ_s be the permutation group of the s distinguished points in S . Let Σ_b be the symmetric group on b . For every $i = 1, \dots, b$, let r_i be the number of boundary components having exactly p_i marked points on it, and Σ_{r_i} be the symmetric group on it. There is a short non-split exact sequence:*

$$0 \rightarrow \text{PMCG}(S, \mathbf{p}) \rightarrow \text{MCG}(S, \mathbf{p}) \rightarrow \bigoplus_{i=1}^b (\Sigma_{r_i} \times \mathbb{Z}_{p_i}) \oplus \Sigma_s \rightarrow 0$$

If $s = 0$ and the p_i are all distincts, $\text{MCG}(S, \mathbf{p})$ is spanned by $R_{\mathbf{p}}$ and the Dehn twists around simple closed curves non-parallel to ∂S .

Moreover, the map $\rho_{\frac{2\pi}{p_i}}$ is in the center of $\text{MCG}(S, \mathbf{p})$ for every $i = 1, \dots, b$.

Let $\text{PMCG}^*(S)$ be the subgroup of $\text{MCG}^*(S, \mathbf{p})$ generated by mapping classes fixing pointwise $\mathcal{S} \cup \partial S$.

Proposition 2.2. *The following holds:*

- (1) *If there exist p_i such that $p_i \geq 3$, then $\text{PMCG}^*(S, \mathbf{p}) = \text{PMCG}(S, \mathbf{p})$.*
- (2) *If $s = 0$ and for all $i = 1, \dots, b$ $|p_i| \leq 2$, then $\text{PMCG}^*(S, \mathbf{p})$ is generated by $\langle \text{PMCG}^*(S), i \rangle$, where i an involution which fixes every point in \mathbf{p} ;*
- (3) *In any other case, $\text{PMCG}^*(S)$ is isomorphic to $\text{PMCG}^*(S, \mathbf{p})$.*

2.1. Arc complexes $A(S, \mathbf{p})$. In this section we will define arc complexes and give some examples in low dimension.

We denote by $A(S, \mathbf{p})$ the simplicial complex whose vertices are the equivalence classes of arcs with endpoints on $\mathcal{P} \cup \mathcal{S}$ modulo isotopies fixing $\mathcal{P} \cup \mathcal{S}$ pointwise. A set of vertices $\langle a_1, \dots, a_k \rangle$ spans a $k - 1$ -simplex if and only if all the vertices can be realized simultaneously as disjoint arcs.

We shall denote by $A_{\sharp}(S, \mathbf{p})$ the subcomplex of $A(S, \mathbf{p})$ spanned by isotopy classes of arcs with both endpoints on \mathcal{P} . If $s = 0$, we have $A_{\sharp}(S, \mathbf{p}) = A(S, \mathbf{p})$. In general $A_{\sharp}(S, \mathbf{p})$ has codimension s in $A(S, \mathbf{p})$.

By an elementary Euler characteristic argument the dimension of simplices is bounded from above. In particular in both $A(S, \mathbf{p})$ and $A_{\sharp}(S, \mathbf{p})$ each simplex of maximal dimension is also a simplex which is maximal with respect to inclusion. Maximal simplices have an interesting geometric interpretation: a maximal simplex in $A(S, \mathbf{p})$ corresponds to a triangulation of S with vertices in $\mathcal{P} \cup \mathcal{S}$, a maximal simplex in $A_{\sharp}(S, \mathbf{p})$ corresponds to a maximal union of once-punctured discs (with punctures in \mathcal{S}) and (immersed) triangles with vertices in \mathcal{P} .

Proposition 2.3. *Let $g, s \geq 0, b \geq 1$ and $\mathbf{p} = (p_1, \dots, p_b) \in (\mathbb{N} \setminus \{0\})^b$. The followings hold:*

- (1) *$A(S, \mathbf{p}) = \emptyset$ if and only if $(g, b, s) = (0, 1, 0)$ and $p_1 \in \{1, 2, 3\}$.*
- (2) *$A(S, \mathbf{p})$ and $A_{\sharp}(S, \mathbf{p})$ have finite dimension respectively $6g + 3b + 3s + |\mathbf{p}| - 7$ and $6g + 3b + 2s + |\mathbf{p}| - 7$.*

- (3) If $(g, b, s) \neq \{(0, 1, 1, (1)), (0, 1, 0, (4))\}$, then $A(S, \mathbf{p})$ is arcwise connected.
- (4) $A(S, \mathbf{p})$ has a finite number of vertices if and only if $g = 0$, $b = 1$ and $s \leq 1$. In particular, $A(S, \mathbf{p})$ is a single point if and only if $g = 0$, $b = 1$, $s = 1$ and $\mathbf{p} = (1)$.

Proposition 2.4 (Low dimensional cases). *The following holds:*

- (1) $(g, b, s, \mathbf{p}) \in \{(0, 1, 0; (4))\}$ if and only if $A(S, \mathbf{p})$ has dimension 0. In particular, $A(S_{0,1,1}; (1))$ is a single point and $A(S_{0,1,0}; (4))$ is made by two disjoint vertices.
- (2) $(g, b, s, \mathbf{p}) \in \{(0, 2, 0; (1, 1)), (0, 1, 0; (5)), (0, 1, 1; (2))\}$ if and only if $A(S, \mathbf{p})$ has dimension 1. In particular, $A(S_{0,2,0}; (1, 1))$ is isomorphic to \mathbb{R} , $A(S_{0,1,0}; (5))$ has diameter 2 and $A(S_{0,1,1}; (2))$ has diameter 3.
- (3) $(g, b, s, \mathbf{p}) \in \{(0, 1, 0; (4)), (0, 1, 1; (1))\}$ if and only if $A_{\sharp}(S, \mathbf{p})$ has dimension 0.

In [12] Penner studies the topology of quotients of these arc complexes through the action of the pure mapping class group, underlining a deep connection with the topology of the moduli space. In particular he proves what follows:

Theorem 2.5 (Penner [12]). *Let $(S_{g,b}^s, \mathbf{p})$ be a compact orientable surface with genus g , $b \geq 1$ boundary components, s marked points in the interior and $\mathbf{p} = (p_1, \dots, p_b)$ marked points on the boundary, with $p_i \geq 1$ for all i . The quotient $Q(S_{g,b}^s, \mathbf{p})$ of $A_{\sharp}(S_{g,b}^s, \mathbf{p})$ by the action of the pure mapping class group $PMCG(S_{g,b}^s, \mathbf{p})$ is a sphere only in the cases*

$$\begin{aligned} Q(S_{0,1}^s, \mathbf{p}) \text{ for } s \geq 0; & \quad Q(S_{0,2}^1, \mathbf{p}) \text{ for } p_1 + p_2 \geq 2; \\ Q(S_{1,1}^1, \mathbf{p}) \text{ for } p_1 \geq 1; & \quad Q(S_{0,2}^0, \mathbf{p}) \text{ for } p_1 + p_2 \geq 2; \\ Q(S_{0,1}^1, \mathbf{p}) \text{ for } p_1 \geq 1; & \quad Q(S_{0,3}^0, \mathbf{p}) \text{ for } p_1 + p_2 + p_3 \geq 3. \end{aligned}$$

Furthermore, $Q(S_{g,b}^s, \mathbf{p})$ is a PL-manifold but not a sphere if and only if $p_i = 1$ for all i and $(g, b, s) \in \{(0, 2, 2), (0, 3, 1), (1, 3, 1), (1, 2, 0)\}$. In all other cases the quotient $Q(S_{g,b}^s, \mathbf{p})$ is not a PL-manifold.

We remark that $A_{\sharp}(S_{g,b}^s, \mathbf{p})$ and $A(S_{g,b}^s, \mathbf{p})$ coincide when $s = 0$. The topology of the non-spherical quotients is still unknown.

2.2. Intersection numbers. Let v_1, v_2 be two vertices in $A(S, \mathbf{p})$. We recall the usual notion of *intersection number* $i(v_1, v_2) = \min|\alpha \cap \beta|$, where α, β are essential arcs on S with α in the homotopy class v_1 and β in the homotopy class v_2 .

Definition 2.6. *Let τ and σ be two simplices in $A(S, \mathbf{p})$ with the same dimension. We say that σ and τ are obtained one from the other by an flip if there exists vertices $v_1 \in \tau$ and $v_2 \in \sigma$ (called flippable) such that the followings properties hold:*

- $i(v_1, v_2) = 1$;
- $i(v_1, w) = 0$ for every $w \in \sigma \setminus v_2$;
- $i(v_2, z) = 0$ for every $z \in \tau \setminus v_1$.

Lemma 2.7 (Known Fact). *Let α, β two maximal simplices in $A(S, \mathbf{p})$. Then there exists a finite sequence τ_0, \dots, τ_n of maximal simplices such that $\tau_0 = \alpha$, $\tau_n = \beta$ and for any $i = 0, \dots, n-1$ τ_{i+1} is obtained by τ_i by a flip.*

The following lemma is adapted from Ivanov's proof in [8].

Invariance Lemma 2.8 (Intersection number). *Let $A(S, \mathbf{p})$ and $A(S', \mathbf{p}')$ be arc complexes of dimension greater than 1. Let $\phi: A(S, \mathbf{p}) \rightarrow A(S', \mathbf{p}')$ be an isomorphism (resp. $A_{\sharp}(S, \mathbf{p})$) For any $\alpha_1, \alpha_2 \in A(S, \mathbf{p})$ (resp. $A_{\sharp}(S, \mathbf{p})$) such that $i(\alpha_1, \alpha_2) = 1$, we have $i(\phi(\alpha_1), \phi(\alpha_2)) = 1$.*

Proof. Since ϕ is an isomorphism, $\dim A(S, \mathbf{p}) = \dim A(S', \mathbf{p}')$ and ϕ sends maximal simplices (that is, triangulations of (S, \mathbf{p})) into maximal simplices (that is, triangulations of (S', \mathbf{p}')). Let α and β be arcs intersecting exactly once, we can extend α to a triangulation τ_{α} such that the

set of arcs $\tau_\beta := (\tau_\alpha \setminus \{\alpha\}) \cup \beta$ is also a triangulation of S . Let τ be the simplex of $A(S, \mathbf{p})$ defined as $\tau = \tau_\alpha \cap \tau_\beta = \tau_\alpha \setminus \alpha = \tau_\beta \setminus \beta$, it has codimension 1. Now $\phi(\tau_\alpha)$ and $\phi(\tau_\beta)$ are triangulations of (S', \mathbf{p}') , and $\phi(\tau) = \phi(\tau_\alpha) \cap \phi(\tau_\beta) = \phi(\tau_\alpha) \setminus \phi(\alpha) = \phi(\tau_\beta) \setminus \phi(\beta)$ has codimension 1. Hence, one can pass from $\phi(\tau_\alpha)$ to $\phi(\tau_\beta)$ with one elementary move. We have necessarily $i(\phi(\alpha), \phi(\beta)) = 1$.

Let us adapt the argument for $A_{\sharp}(S, \mathbf{p})$. Let \mathcal{V} be the set of all vertices of $A_{\sharp}(S, \mathbf{p})$ which correspond to simple closed loops around exactly one marked point in \mathcal{S} . It is easy to see that any maximal simplex σ of $A_{\sharp}(S, \mathbf{p})$ contains exactly s disjoint elements of \mathcal{V} . Now let $\alpha_1, \alpha_2 \in A_{\sharp}(S, \mathbf{p})$ be such that $i(\alpha_1, \alpha_2) = 1$. Notice that for each $v \in \mathcal{V}$ we have $i(v, \alpha) \neq 1$ for all $\alpha \in A_{\sharp}(S, \mathbf{p})$, so nor α_1 nor α_2 are elements in \mathcal{V} . Let us extend α_1, α_2 to maximal simplices $\sigma_{\alpha_1}, \sigma_{\alpha_2}$ such that $\sigma_{\alpha_2} = \langle \sigma_{\alpha_1} \setminus \alpha_1, \alpha_2 \rangle$ is the simplex spanned by $\sigma_{\alpha_1} \setminus \alpha_1$ and α_2 . Let us define $\sigma_0 = \sigma_{\alpha_1} \cap \sigma_{\alpha_2}$, it is a simplex of codimension 1. We have that $\phi(\sigma_{\alpha_1}) = \langle \phi(\sigma_{\alpha_0}), \phi(\alpha_1) \rangle$ and $\phi(\sigma_{\alpha_2}) = \langle \phi(\sigma_{\alpha_0}), \phi(\alpha_2) \rangle$ are both maximal simplices in $A_{\sharp}(S, \mathbf{p})$. Now let us realize $\phi(\sigma_0)$ and look at its complement on S . Since $\phi(\sigma_0)$ has codimension 1, its complement contains at most one element of \mathcal{V} . If the complement contains exactly one element $v \in \mathcal{V}$, then we would have $v = \phi(\alpha_1) = \phi(\alpha_2)$, in contradiction with the injectivity: in fact the simplices $\phi(\sigma_{\alpha_1}), \phi(\sigma_{\alpha_2})$ being both maximal simplices, both of them have the same number s of elements of \mathcal{V} . We thus have that all the complementary regions of $\phi(\sigma_0)$ are all open triangles except one open square which should contain both $\phi(\alpha_1)$ and $\phi(\alpha_2)$. We then conclude that $i(\phi(\alpha_1), \phi(\alpha_2)) = 1$. \square

This leads us to state the following lemma, which gives a useful criterion to establish whether two automorphisms coincides or not.

Lemma 2.9. *Let $\phi_1, \phi_2 \in \text{Aut}A(S, \mathbf{p})$. If there exists a maximal simplex $\sigma = \langle a_1, \dots, a_M \rangle$ in $A(S, \mathbf{p})$ such that $\phi_1(a_i) = \phi_2(a_i)$ for all $i = 1, \dots, M$, then $\phi_1(v) = \phi_2(v)$ for all $v \in A(S, \mathbf{p})$.*

Lemma 2.10. *Let $v \in A(S_{g,b}^s, \mathbf{p})$ be a vertex corresponding to an arc which separates S into subsurfaces (S_1, \mathbf{p}_1) and (S_2, \mathbf{p}_2) . If $\phi, \psi \in \text{Aut}A(S_{g,b}^s, \mathbf{p})$ fix v and coincide on each vertex of $A(S_1, \mathbf{p}_1)$ and $A(S_2, \mathbf{p}_2)$, then $\phi = \psi$.*

2.3. Invariance lemmas and proof of Theorem C. The goal of this section is to state some Invariance Lemmas which will be used throughout the paper and to prove Theorem C.

Let us first recall some well-known definitions of simplicial topology we will use in the rest of the paper (a classical reference is [4]).

Let K be a nonempty simplicial complex and let σ be one of its simplices. The *link* $\text{Lk}(\sigma, K)$ of σ is the subcomplex of K whose simplices are the simplices τ such that $\sigma \cap \tau = \emptyset$ and $\sigma \cup \tau$ is a simplex of K . Let K_1 and K_2 be two simplicial complexes whose vertex sets V_1 and V_2 are disjoint. The *simplicial join* of K_1 and K_2 is the simplicial complex $K_1 \star K_2$ with vertex set $V_1 \cup V_2$; a subset of $V_1 \cup V_2$ is a simplex $K_1 \star K_2$ if and only if it is a simplex of K_1 , a simplex of K_2 or the union of a simplex of K_1 and a simplex of K_2 . We have $\dim(K_1 \star K_2) = \dim K_1 + \dim K_2 + 1$. The *simplicial cone* $C(K)$ over K is the join of K with only one vertex $\{w_0\}$.

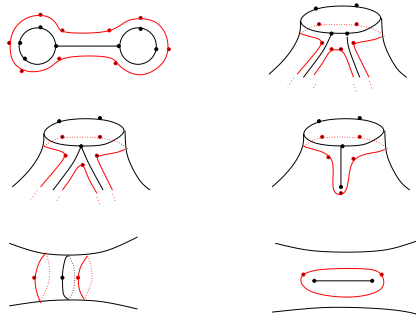

FIGURE 1. Cutting along nonseparating arcs on S

We remark that in the case of arc complexes, the link of a vertex has a precise geometrical meaning: if the vertex corresponds to a non separating arc, its link is the arc complex of the surface obtained by cutting along that arc (up to adding a suitable number of marked points on its new boundary components); if it is a separating arc, then its link corresponds to the join of the arc complexes of the two connected components (up to adding a suitable number of new marked points on the new boundary components), see Figure 1.



FIGURE 2. A 3-leaf, a 3-petal and a 4-petal

Let $S = (S_{g,b}^s, (p_1, \dots, p_b))$, and \mathcal{B}_i be the its i -th boundary component. If $p_i \geq 4$ (resp. $p_i \geq 3$) we call a 4-petal (resp. a 3-petal) an arc which runs parallel to \mathcal{B}_i , joins two distinct marked points and bounds a disc containing exactly 4 (resp. 3) marked points on its boundary (see Figure 2). If $p_i \geq 2$, we call a p_i -leaf any loop based at one marked point and running parallel to \mathcal{B}_i . By the previous discussion we have for instance that if l is a p_1 -leaf $\text{Lk}(l) = A(S_{0,1,0}, (p_1 + 1)) \star A(S_{g,b}^s, (1, p_2, \dots, p_b))$, if m is a j -petal around the first boundary component then $\text{Lk}(m) = A(S_{0,1,0}, (j)) \star A(S_{g,b}^s, (p_1 - j + 2, p_2, \dots, p_b))$.

The following remark is immediate and very useful.

Remark 2.11. *The following holds:*

- (1) $\text{Lk}(v, A(S, \mathbf{p}))$ (resp. $\text{Lk}(v, A_{\#}(S, \mathbf{p}))$) is made of two disjoint vertices if and only if $(g, s, b, \mathbf{p}) = (0, 1, 0, (4))$ (resp. $(g, s, b, \mathbf{p}) \in \{(0, 1, 0, (4)), (0, 1, 1, (2))\}$).
- (2) Let $\dim A_{\#}(S, \mathbf{p}) \geq 1$, and let v_1, v_2 be two vertices in $A(S, \mathbf{p})$ (resp. $A_{\#}(S, \mathbf{p})$). $\text{Lk}(v_1) = \text{Lk}(v_2)$ as subsets of $A(S, \mathbf{p})$ (resp. $A_{\#}(S, \mathbf{p})$) if and only if $v_1 = v_2$.
- (3) $A(S, \mathbf{p})$ is a cone if and only if $(g, s, b, \mathbf{p}) = (0, 1, 1, (1))$, namely if $A(S, \mathbf{p})$ is a point.
- (4) The join of two arc complexes is a cone if and only if one of the two arc complexes is $A(S_{0,1,1}, (1))$.

Let us now make some useful remark on the diameters of the arc complexes.

Remark 2.12. *The following holds:*

- (1) $\text{diam} A_{\#}(S_{g,b}^s, (1_b)) \geq \text{diam} A(S_{g,b}^s, (1_b)) \geq \text{diam} A(S_{g,b+s})$.
- (2) If $\text{diam} A(S_{g,b+s}) = \infty$, then either $A(S_{g,b}^s, (p_1, \dots, p_b))$ has infinite diameter or it contains a simplex σ with $\text{Lk}(\sigma) \cong A(S_{g,b}^s, (1_b))$ which has infinite diameter. The same statement holds for $A_{\#}(S_{g,b}^s, \mathbf{p})$.
- (3) If there exists i such that $p_i \geq 5$, then $\text{diam} A(S_{g,b}^s, \mathbf{p}) = 2$.

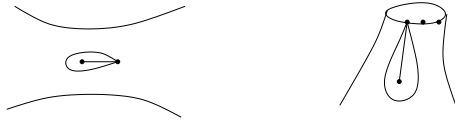

FIGURE 3. Lemma 2.13

By brevity, we will say that an arc on (S, \mathbf{p}) is a *drop* if it is a simple loop based on a point bounding a disc with a puncture (see Figure 3). An edge $\langle l, v \rangle$ in $A(S, \mathbf{p})$ is an *edge-drop* if it corresponds to the arc complex of once punctured disc embedded in S as in Figure 3. An arc on (S, \mathbf{p}) is *properly separating* if it is separating and is not a 3-petal, a 3-leaf or a drop.

Invariance Lemma 2.13 (Separating arcs). *Let us denote with $\mathcal{A}(S_{g,b}^s, \mathbf{p})$ the arc complexes $A(S_{g,b}^s, \mathbf{p})$ or $A_{\sharp}(S_{g,b}^s, \mathbf{p})$. Assume $\dim \mathcal{A}(S_{g,b}^s, \mathbf{p}) \geq 2$.*

The following holds:

- (1) *Let $\phi : \mathcal{A}(S_{g,b}^s, \mathbf{p}) \rightarrow \mathcal{A}(S_{g',b'}^{s'}, \mathbf{p}')$ be an isomorphism. If l is a properly separating arc, then $\phi(l)$ is a properly separating arc on S' .*
- (2) *A vertex l is a drop if and only if its link in $\mathcal{A}(S_{g,b}^s, \mathbf{p})$ is a cone.*
- (3) *Let $\phi : A(S_{g,b}^s, \mathbf{p}) \rightarrow A(S_{g',b'}^{s'}, \mathbf{p}')$ be an isomorphism. If $\langle l, v \rangle$ is an edge-drop, then also the edge $\langle \phi(l), \phi(v) \rangle$ is an edge-drop.*

Proof. 1. By hypothesis $Lk(l) = A_1 \star A_2$ where both A_1 and A_2 are two arc complexes with more than one vertex. Since ϕ is an automorphism $Lk(\phi(l)) \cong A_1 \star A_2$. If it were a non-separating arc or a 2-leaf or a 3-leaf, then its link would contain a finite simplex whose link would have infinite diameter (Proposition 2.12) and this doesn't happen in $A_1 \star A_2$.

2. If l is a simple loop as in the hypothesis its link is a cone. On the other hand, if v is a vertex corresponding to a 2-leaf or a 3-petal or an arc which doesn't disconnect the surface, its link is an arc complex of some "large" surface, hence it is not a cone by Proposition 2.11. If v is a vertex as in Statement 1, we conclude again by Proposition 2.11.

3. Let l be the loop which wraps up the puncture, then $Lk(l) = \{v\} \star A$ for some arc complex A . By the above case, $\phi(l)$ is a loop of the same type and $Lk(\phi(l)) = \{\phi(v)\} \star \phi(A)$. \square

From the previous lemma we deduce the following:

Proposition 2.14. *Let \mathcal{S} be the set of marked points in the interior of S , with $|\mathcal{S}| = s$. It holds:*

- (1) *If $A(S_{g,b}^s, \mathbf{p})$ is isomorphic to $A(S_{g',b'}^{s'}, \mathbf{p}')$, then $s' = s$.*
- (2) *If α is an arc joining two points in \mathcal{S} , then the image of α through an isomorphism is also an arc joining two points in \mathcal{S} .*

Proof. By Lemma 2.13, simple closed loops bounding a once-punctured disc are simplicial invariants. The maximal dimension of a simplex in $A(S_{g,b}^s, \mathbf{p})$ generated by such vertices is s , by simpliciality we thus have $s = s'$. \square

Lemma 2.15. *Let us denote with $\mathcal{A}(S, \mathbf{p})$ the arc complexes $A(S, \mathbf{p})$, $A_{\sharp}(S, \mathbf{p})$. The following holds:*

- (1) *Let $K_1 = \{a, b\}$ (isomorphic to $A(S_{0,1}^0, (4))$ or $A_{\sharp}(S_{0,1}^1, (2))$) and $K_2 = \mathcal{A}(S, \mathbf{p})$ of dimension at least 1.
If K'_1 and K'_2 are arc complexes such that $K_1 \star K_2 \cong K'_1 \star K'_2$, then up to reordering $K'_1 \cong K_1$ and $K'_2 \cong K_2$.*
- (2) *Let $K_1 = A(S_{0,2}^0, (1, 1)) = \mathbb{R}$ and K_2 be an arc complex with infinite vertices.
If K'_1 and K'_2 are arc complexes such that $K_1 \star K_2 \cong K'_1 \star K'_2$, then up to reordering $K'_1 \cong K_1$ and $K'_2 \cong K_2$.*

Proof. 1. The pair $\{a, b\}$ is the unique pair of vertices in $K_1 \star K_2$ whose links coincide. Let $\phi : K_1 \star K_2 \rightarrow K'_1 \star K'_2$ be an isomorphism; $\phi(a)$ and $\phi(b)$ are necessarily in the same K'_i (otherwise they would be connected by an edge). Since K'_i is an arc complex as well, it contains two vertices with the same link if and only if it is isomorphic to K_1 (Proposition 2.11).

2. Let $v \in K_1 = A(S_{0,2}^0, (1, 1)) = \mathbb{R}$, and let $\phi : K_1 \star K_2 \rightarrow K'_1 \star K'_2$ be an isomorphism. Assume that $\phi(v) \in K'_1$; we have

$$\{a, b\} \star K_2 = Lk(v, K_1 \star K_2) \cong Lk(\phi(v), K'_1 \star K'_2) = Lk(\phi(v), K'_1) \star K'_2.$$

Now $Lk(\phi(v), K'_1)$ is either isomorphic to a join of arc complexes $A_1 \star A_2$ or is an arc complex itself. An argument similar to the one used in the previous case allows us to exclude the first case: $(A_1 \star A_2) \star K'_2 \cong \{a, b\} \star K_2$ implies that $\{a, b\}$ coincides entirely with one of the factors and K_2 coincides with the join of the other two (this is impossible because the complexes have different diameters). Since we have found that $Lk(\phi(v), K'_1)$ is an arc complex, by the

previous case either $Lk(\phi(v), K'_1) \cong \{a, b\}$ or $K_2 \cong \{a, b\}$ (that is impossible). We thus have $Lk(\phi(v), K'_1) \cong \{a, b\}$, hence $\dim K'_1 = 1$. We conclude by considering the 3 cases listed in the statement 2 of Proposition 2.4. \square

Invariance Lemma 2.16 (Petals). *Let $\phi : A(S_{g,b}^s, \mathbf{p}) \rightarrow A(S_{g',b'}^{s'}, \mathbf{p}')$ be an isomorphism between arc complexes of dimension at least 2.*

The following holds:

- (1) *If l_1 is a 3-leaf, then $\phi(l_1)$ is a 3-leaf.*
- (2) *If l_2 is a 4-petal, then $\phi(l_2)$ is a 4-petal.*
- (3) *If l_3 is a 3-petal, then $\phi(l_3)$ is a 3-petal. Moreover, if l_i is based on a boundary component having exactly p marked points, $\phi(l_i)$ is also based on a boundary component with the same number of marked points.*

Proof. 1. and 2. Let us notice that 3-leaves and 4-petals are the only vertices which disconnect a surface with one connected component of type $(S_{0,1,0}, (4))$. By Lemma 2.15 we just have to prove that in the case $A(S_{g,b}^s, \mathbf{p})$ contains both a 3-leaf l_1 and a 4-petal l_2 , $\phi(l_1)$ cannot be a 4-petal and $\phi(l_2)$ cannot be a 3-leaf of $A(S_{g',b'}^{s'}, \mathbf{p}')$.

Assume that l_1 is based on the first boundary component \mathcal{B}_1 , and l_2 is based on \mathcal{B}_2 (resp. $p_1 = 3$ and $p_2 \geq 4$), namely $Lk(l_1, A(S_{g,b}^s, \mathbf{p})) \cong A(S_{0,1,0}, (4)) \star A(S_{g,b}^s, (1, p_2, \dots, p_b))$ and $Lk(l_2, A(S_{g,b}^s, \mathbf{p})) \cong A(S_{0,1,0}, (4)) \star A(S_{g,b}^s, (3, p_2 - 2, \dots, p_b))$.

Let ρ_1 (resp. ρ_2) be the $\frac{2\pi}{3}$ -rotation (resp. the $\frac{2\pi}{p_2}$ -rotation) around \mathcal{B}_1 (resp. \mathcal{B}_2). We remark that for any $i = 0, 1, 2$ the arc represented by $\rho_1^i(l_1)$ (resp. $\rho_2^i(l_2)$) is a 3-leaf (resp. a 4-petal), and the intersection patterns for these families of arcs are $i(\rho_1^i(l_1), \rho_1^{j\pm 1}(l_1)) = 2\delta_{ij}$ for $i, j = 0, 1, 2$, and $i(\rho_2^h(l_2), \rho_2^{k\pm 1}(l_2)) = \delta_{hk}$ for $h, k = 0, \dots, p_2 - 1$.

By the simplicial invariance of their intersection number, we deduce that the arcs $\{\phi(\rho_2^j(l_2))\}_{j=0, \dots, p_2-1}$ are all based on the same boundary component of S' , and the arcs are all of the same type (i.e. either they are all 3-leaves or they are all 4-petals). Since $p_2 \geq 4$, we deduce that they are necessarily 4-petals, hence $\phi(l_1)$ is necessarily a 3-leaf.

3. Remark that for every 3-petal l_3 based on the i -th boundary component there exists a 4-petal (or a 3-leaf, in the case $p_i = 3$) l_4 based on that same component such that $Lk(l_4, A(S, \mathbf{p})) = \{l_3, \rho_i(l_3)\} \star A(S_{g',b'}^{s'}, \mathbf{p}') \cong A(S_{0,1,0}, (4)) \star A(S_{g',b'}^{s'}, \mathbf{p}')$. By Lemma 2.15 and the previous case, we deduce that $\phi(l_4)$ is also a 4-petal (or a 3-leaf when $p_i = 3$), and the same holds for all the $\rho_i^j(l_4)$'s as well. The number p_i of points on the i -th boundary component of S is necessarily equal to the number of 3-petals based on it. Since $i(\rho^j(l_3), \rho^{j\pm 1}(l_3)) = 1$ for all $j = 0, \dots, p_i - 1$, our conclusion follows by simpliciality as in the previous case. \square

The same argument also proves the following:

Corollary 2.17. *Let $\mathcal{A}(S, \mathbf{p})$ be $A(S, \mathbf{p})$ or $A_{\sharp}(S, \mathbf{p})$. If $A(S_{g,b}^s, \mathbf{p})$ is isomorphic to $A(S_{g',b'}^{s'}, \mathbf{p}')$, then for every $p_i \geq 3$ there exists $p'_j = p_i$. Moreover, $\sum_{p_i \geq 3} p_i = \sum_{p'_j \geq 3} p'_j$.*

Following the usual definition, we say that a *non-separating* arc on S is an arc which does not disconnect the surface.

Invariance Lemma 2.18 (Non-separating arcs). *Let $(S_{g,b}^s, \mathbf{p})$ be an oriented surface whose arc complex have dimension at least 2, and let $\phi : A(S_{g,b}^s, \mathbf{p}) \rightarrow A(S_{g',b'}^{s'}, \mathbf{p}')$ be an isomorphism. The following holds:*

- (1) *if v is a non-separating arc, then $\phi(v)$ is also a non-separating arc;*
- (2) *if w is a 2-leaf, then also $\phi(w)$ is a 2-leaf.*

Proof. WLOG assume v joins the first and the second boundary component, hence $Lk(v) = A(S_{g',b-1}^{s'}, (p_1 + p_2 + 2, p_3, \dots, p_b))$. By Lemma 2.16 $\phi(v_1)$ is either a non-separating arc or a 2-petal. Now by simpliciality it holds $Lk(\phi(v)) \cong A(S_{g',b-1}^{s'}, (p_1 + p_2 + 2, p_3, \dots, p_b))$, with $p_1 + p_2 + 2 \geq 4$. If $\phi(v)$ were a 2-petal, $Lk(\phi(v)) = A(S_{g',b}^{s'}, \mathbf{p}')$, with $p'_i = 1$ for some i and

$p'_j = p_j$ for all $j \neq i$. Now $\sum_{p'_h \geq 3} p'_h = \sum_{p_h \geq 3} p_h < p_1 + p_2 + 2 + \sum_{p_h \geq 3, h \geq 3} p_h$ in contradiction with Corollary 2.17. The same argument also proves that $\phi(w)$ is necessarily a 2-leaf. \square

It easily follows by the arguments in Lemma 2.16:

Corollary 2.19. *Let $\phi \in \text{Aut}A(S, \mathbf{p})$ be an automorphism. The followings hold:*

- (1) *For every boundary component \mathcal{B} of S there exists $f \in \text{MCG}^*(S, \mathbf{p})$ such that $f_\star \circ \phi$ fixes every 3-petal (or every 2-leaf) on \mathcal{B} .*
- (2) *If $f \in \text{MCG}^*(S, \mathbf{p})$ fixes two intersecting 3-petal (or 2-leaves), then ϕ fixes every 3-petal (or 2-leaves).*

Invariance Lemma 2.20 (Leaves). *Let l be an n -leaf on $A(S_{g,1,s}, (n))$, then $\phi(l)$ is an n -leaf.*

Proof. Notice that there exists a unique 3-petal v which intersects l , and there is no non-separating arc α such that $i(\alpha, l) = i(\alpha, v) = 0$. By simpliciality and Lemma 2.18, the same properties hold for $\phi(l)$. By Lemma 2.13 $\phi(l)$ is a separating loop. If both the connected components bounded by $\phi(l)$ were different from $(S_{0,1,0}, (n+1))$, there would be a non-separating arc disjoint from both the 3-petal $\phi(v)$ and $\phi(l)$, and we would get a contradiction. \square

Theorem C. *If $A(S_{g,b}^s, \mathbf{p})$ is isomorphic to $A(S_{g,b'}^{s'}, \mathbf{p}')$, then $s = s'$, $b = b'$ and $p_i = p'_i$ for all i .*

By sake of brevity, we will introduce the following definitions.

Definition 2.21. *An arc complex $A(S_{g,b}^s, \mathbf{p})$ is rigid if its automorphism group $\text{Aut}(A(S_{g,b}^s, \mathbf{p}))$ is isomorphic to the mapping class group of the underlying surface $\text{MCG}^*(S_{g,b}^s, \mathbf{p})$. We shall say that $A(S_{g,b}^s, \mathbf{p})$ is almost-rigid if the natural homomorphism $\text{MCG}^*(S_{g,b}^s, \mathbf{p}) \rightarrow \text{Aut}(A(S_{g,b}^s, \mathbf{p}))$ is surjective.*

Therefore, when there is topology enough, the notions of rigidity and almost-rigidity are equivalent.

Proposition 2.22. *If $A(S_{g,b}^s, \mathbf{p})$ is almost-rigid, then $A(S_{g,b}^s, \mathbf{p})$ is rigid.*

3. BASIC CASES

In this section we prove Theorem A for some genus 0 surfaces and for surfaces with one boundary component. A key ingredient in our proofs will be the Reduction Lemmas, which will be proved by the use of the Invariance Lemmas stated in Section 2.

Reduction Lemma 1. *For any $s \geq 0$ and $g \geq 0$, if $A(S_{g,1}^0, (1))$ is almost-rigidity, then also $A(S_{g,1}^s, (1))$ is almost-rigid.*

Proof. Let $\phi \in \text{Aut}(A(S_{g,1,s}, (1)))$ be an automorphism. For every $i = 1, \dots, b$, let $\langle l_i, v_i \rangle$ be an edge as in Lemma 2.13 (3), corresponding to the i -th puncture. Without loss of generality, we can assume that the set of all pairs $\{l_i, v_i\}_i$ spans a simplex on $A(S_{g,1,s}, (1))$ and, by Lemma 2.13, $\phi(l_i) = l_i$ and $\phi(v_i) = v_i$ for all $i = 1, \dots, s$. By restriction, we have that ϕ induces an automorphism $\phi|_1$ on $Lk(\sigma) = A(S_{0,1,0}, (1))$. By hypothesis, $\phi|_1$ is induced by a homeomorphism $\tilde{\phi}: (S_{0,1,0}, (s+1)) \rightarrow (S_{0,1,0}, (s+1))$.

Claim: $\tilde{\phi}$ restricts to the identity on the boundary of $(S_{0,1,0}, (s+1))$.

By 2.18 we can equivalently show that $\tilde{\phi}$ fixes every 3-petal on $(S_{0,1,0}, (s+1))$. Let us denote by l_{ii+1} the 3-petal of $(S_{g,1,0}, (s+1))$ which joins the i -th and the $i+1$ -th marked point on the boundary of $(S_{0,1,0}, (s+1))$. Let a_{ii+1} be the arc joining the i -th and the $i+1$ -th puncture of $(S_{0,1,0}, (s+1))$ as it is shown in the Figure 4. The intersection pattern of the a_{ii+1} 's, of the l_j 's and l_{ii+1} 's is the following:

$$\begin{aligned} i(a_{i,i+1}, l_i) &= i(a_{ii+1}, l_{i+1}) = 1 \\ i(a_{ii+1}, l_k) &= 0 \text{ for } i \neq k \\ i(a_{i,i+1}, l_{i+1,i+2}) &= i(l_{i+1,i+2}, a_{i+2,i+3}) = 1 \\ i(a_{h,h+1}, l_{k+1,k+2}) &= i(l_{k+1,k+2}, a_{h+2,h+3}) = 0 \text{ for } h \neq k \end{aligned}$$

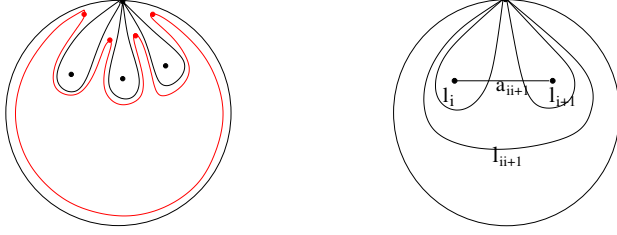

FIGURE 4. Proposition 3.2.2 in genus 0 case

Using Lemmas 2.14-(2), 2.16 and the automorphism invariance of the intersection patterns given above, we immediately deduce that $\phi(l_{ii+1}) = l_{ii+1}$ for all i .

By the claim, we can extend $\tilde{\phi}$ to a homeomorphism of the surface just glueing back the punctured discs bounded by the l_i 's. \square

3.1. **Genus 0.** Here we prove Theorem A for some genus 0 surfaces.

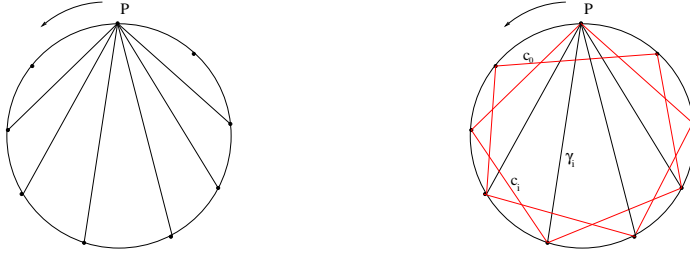

FIGURE 5. Fans and chords

3.1.1. *Polygon* $(S_{0,1}^0, (n))$, with $n \geq 4$. Let $(S_{0,1}^0, \mathbf{p})$ be a polygon with a set of \mathbf{p} ($|\mathbf{p}| = n \geq 4$) marked points on its boundary. Let us endow \mathbf{p} with the (cyclic) order induced by the orientation of ∂S . For any point $P \in \mathbf{p}$, the *fan* based in P is the triangulation F_P as in Figure 5. For any $Q \in \mathbf{p}$, the *chord* based at Q is the isotopy class of any essential arc joining the two marked points adjacent to Q . Let \mathcal{C} be the set of chords of $(S_{0,1}^0, \mathbf{p})$. We shall enumerate the arcs $c_i \in \mathcal{C}$ with respect to the (cyclic) order of their base point in \mathbf{p} , so that $i(c_i, c_{i\pm 1}) = 1$ for $i = 0, \dots, n-1$ and $i(c_i, c_j) = 0$ for $|i-j| \neq 1$.

We characterize fan triangulations and the action of simplicial automorphisms on them as follows:

Lemma 3.1. *Let $\phi : A(S_{0,1}^0, (n)) \rightarrow A(S_{0,1}^0, (n))$ be an automorphism. The following holds:*

- (1) *A triangulation T is a fan if and only if there exists a point $P \in \mathbf{p}$ such that $Lk(c_P, A(S, \mathbf{p})) \cap T = \emptyset$, where c_P is the chord based at P .*
- (2) *If \mathcal{C} is the set of chords of S , then $\phi(\mathcal{C}) = \mathcal{C}$, and ϕ either preserves or reverses the cyclic order of the chords.*
- (3) *Let $F_P = \{\gamma_i\}$ be the fan based at P , where γ_i is the arc which connects P to the i -th point of \mathbf{p} according to the (cyclic) order on \mathbf{p} . There exists $P' \in \mathbf{p}$ such that the triangulation $\phi(F_P) = \{\phi(\gamma_i)\}$ is a fan triangulation $F_{P'}$. The map ϕ either preserves or reverses the order of arcs in F_P .*

Proof. The first two statements easily follow from our definition.

Let us prove the third statement. By the simpliciality of our maps, $\phi(T)$ is a triangulation, and $\phi(Lk(\tilde{a}, A(S_{0,1,0}, \mathbf{p})) \cap T) = Lk(\phi(\tilde{a}), A(S_{0,1,0}, \mathbf{p})) \cap \phi(T)$. Let $c_i \in \mathcal{C}$. Up to cyclic permutations of the indices we have for all $j = 0, \dots, n-1$ and for all $i \neq 0, 1, n-1$ $i(c_i, \gamma_j) = \delta_{ij}$. Moreover

$i(c_0, \gamma_j) = 1$ for all γ_j . By simpliciality, the same relations hold when we replace γ_j by $\phi(\gamma_j)$ and c_i by $\phi(c_i)$. Moreover by Statement 2 we have $\phi(\mathcal{C}) = \mathcal{C}$. An application of Statement 1 (with $c_P = \phi(c_0)$) concludes the proofs. \square

Theorem A (Plane polygons). *For any $n \geq 4$, $A(S_{0,1}^0, (n))$ is almost-rigid.*

Proof. By Lemma 2.9 it is enough to prove that if F_P is a fan and $\phi(F_P)$ is its image through ϕ , then there exists a homeomorphism $\tilde{\phi}$ such that $\tilde{\phi}_*$ agrees with ϕ on each arc of F_P .

Up to precomposition with a rotation $\rho_{\frac{2\pi}{n}}$, we assume $\phi(F_P) = F_P$. By Lemma 3.1, the order of arcs in F_P is either preserved or reversed. Up to precomposition with a reflection, we can assume that ϕ preserves the order of arcs in F_P . Up to isotopies, we also assume that ϕ fixes each arc point wise. We conclude by extending ϕ to a homeomorphism of the disc by the identity on the inner triangles. \square

We remark that the following is a well-known fact. A proof can be found for instance in [2].

Theorem 3.2. *$A(S, \mathbf{p})$ is PL-homeomorphic to \mathbb{S}^{n-4} .*

Let us now deal with punctured polygons. As in the previous case, the following holds:

Theorem A (Punctured polygons). *For $n \geq 1$, $s \geq 1$, $A(S_{0,1,s}, (n))$ is almost-rigid.*

Proof. The case $n = 1$ and $s \geq 1$ follows immediately from Proposition 3.2.2.

The case $n \geq 2$ and $s \geq 1$ goes in similar way. By Lemma 2.19 and 2.20, we can assume that ϕ fixes any 3-petal and any 3-leaf. Let l be an n -leaf, it disconnects S into $(S_{0,1,s}, (1))$ and $(S_{0,1,0}, (n+1))$. The map ϕ induces automorphisms of $A(S_{0,1,s}, (1))$ and $A(S_{0,1,0}, (n+1))$. As in the previous case, both of them are induced by homeomorphisms which restricts to the identity on their boundary. We can then glue them together, and we find an homeomorphism of the surface. \square

3.1.2. *Annuli.* In the following section we shall study the annuli $(S_{0,2}^s, (p_1, p_2))$. We denote by ρ_1 and ρ_2 the two rotations (respectively of $\frac{2\pi}{p_1}$ and $\frac{2\pi}{p_2}$) around the two boundary components of S , and by i the inversion which exchanges the two boundary components of the surface.

In some easy cases there exists a precise description of the geometry of the complexes.

Example 3.3 (Annulus $(S_{0,2}^0, (1, 1))$).

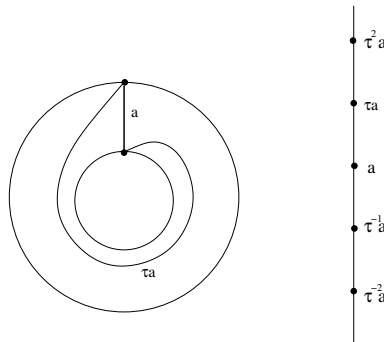

FIGURE 6. Annulus

If a is an arc as in Figure 6, then $\text{MCG}^*(S_{0,2}^0, (1, 1))$ is spanned by $\langle \tau, r, i \rangle$, where τ is the Dehn twist along the core curve of the annulus, r is the reflection with respect to a , and i is the inversion which exchanges the two boundary components of S . Since for any arc α in $A(S_{0,2}^0, (1, 1))$ we have $i(\alpha, \tau\alpha) = 0$, $A(S_{0,2}^0, (1, 1))$ is isomorphic to the real line.

Notice that the natural homomorphism $\text{MCG}^*(S_{0,2}^0, (1, 1)) \rightarrow \text{Aut}A(S_{0,2}^0, (1, 1))$ is surjective but not injective: r and i have the same image.

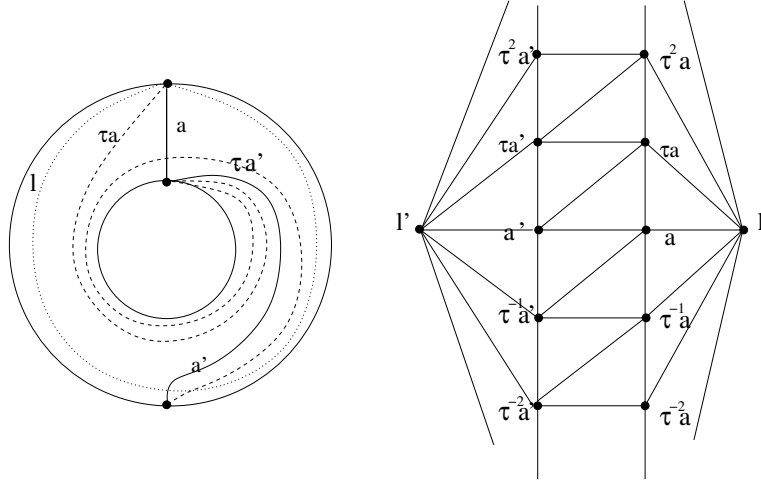

FIGURE 7

Example 3.4 (Annulus $(S_{0,2}^0, (1, 2))$).

Let τ be the Dehn twist around the core of the annulus, let ρ be the π -rotation which exchanges the two marked points and let r be the reflection which fixes the three marked points. It is easy to see that the group $\text{MCG}^*(S_{0,2}^0, (1, 2))$ is generated by the elements τ, ρ, r .

Let a, a' be arcs as in Figure 7. Let l be the loop around the upper point on the outer boundary component of S , and let l' be the loop around the lower point of the boundary component of S . It is not too difficult to see that the complex $A(S_{0,2}^0, (1, 2))$ looks like the strip in Figure 7. It is not too difficult to use this configuration to deduce directly that the natural homomorphism $\text{MCG}^*(S_{0,2}^0, (1, 2)) \rightarrow \text{Aut}A(S_{0,2}^0, (1, 2))$ is surjective.

Theorem A (Annuli). *For any $p_1, p_2 \in \mathbb{N}$, $A(S_{0,2}^s, (p_1, p_2))$ is almost-rigid. If $s = 0$ and $p_1 = p_2 = 1$, $A(S_{0,2}^s, (p_1, p_2))$ is not rigid.*

Proof. Let a be an arc joining the two boundary components. Let ϕ be an automorphism of $A(S_{0,2,s}, (p_1, p_2))$. By Lemma 2.18, we can assume $\phi(a) = a$ and by Lemma 2.19 we can assume that ϕ fixes every 3-leaf in the first boundary component. Cutting the surface along a , we find a new surface $(S_{0,1,s}, (p_1 + p_2 + 2))$. The map ϕ induces by restriction an automorphism which fixes at least two intersecting 3-petals. By Lemma 2.19, $\phi|_1$ fixes any other 3-petal. By Theorem 3.1.1, $\phi|_1$ is induced by an homeomorphism of the surface, which restricts to the identity on the boundary. We can just glue back the two pieces of the boundary coming from the cut along a and get a homeomorphism of the annulus inducing ϕ .

To prove the second statement just notice that r and i have the same image. \square

3.2. Case $b = 1$. Let us work now on the pair $(S_{g,1}^0, (1))$. We will denote as P the unique marked point on the boundary of S .

3.2.1. The forgetful map. Let τ be the Dehn-twist around the boundary of S , τ is not the identity in $\text{MCG}^*(S_{g,1}^0, P)$.

Let α be a vertex in $A(S_{g,1}, P)$. Realize α as a simple closed curve a on S , and consider the curves a^+, a^- obtained from a by twisting only one of its two endpoints (see Figure 8 9) and remark that $\tau a^- = a^+$.

The curves $\{\tau^n a, \tau^n a^-, \tau^n a^+\}_{n \in \mathbb{N}}$ are all represented by the same vertex in $A(S)$, and they all give different vertices in $A(S, P)$. Remark that each vertex of $A(S, P)$ “induces” a vertex in $A(S)$ through a natural *forgetful map* $f : A(S, P) \rightarrow A(S)$, which sends $[a]_{rel P} \rightarrow [a]_S$.

It is easy to prove the following:

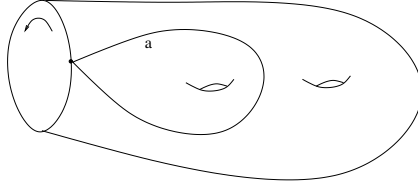

FIGURE 8

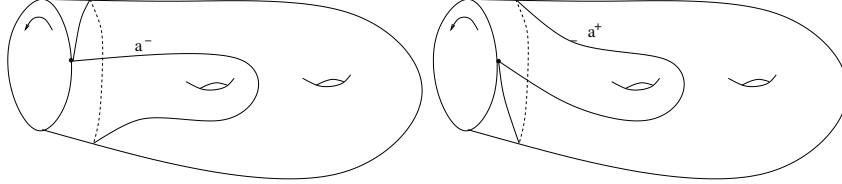

FIGURE 9

Lemma 3.5. *Let $f : A(S, P) \ni [a]_{rel P} \rightarrow [a]_S \in A(S)$ the natural forgetful map. The following holds:*

- (1) *f is well-defined and surjective, and for every $[a] \in A(S)$, $f^{-1}([a])$ is a 1-dimensional simplicial complex isomorphic to \mathbb{R} .*
- (2) *If $\phi \in \text{Aut}(A(S, P))$ is an automorphism induced by an element of $\text{MCG}^*(S, P)$, then for every $a \in A(S, P)$ the restriction of ϕ is an isomorphism: $\phi| : f^{-1}([a]) \rightarrow f^{-1}([\phi(a)])$. Moreover there is a well-defined simplicial map $f(\phi) : A(S) \ni [a] \rightarrow A(S) \ni f([\phi(a)])$ which is also an automorphism.*
- (3) *If $\tau : (S, P) \rightarrow (S, P)$ is the Dehn twist around ∂S , then $\tau_* : A(S, P) \rightarrow A(S, P)$ is a 2-translation on all fibers $f^{-1}([a])$, and $f(\phi) : A(S) \rightarrow A(S)$ is the identity.*

The following two lemmas clarify some of the properties of f .

Lemma 3.6. *Let $\sigma : A(S, P) \rightarrow A(S, P)$ be an automorphism such that $f(\sigma) : A(S) \rightarrow A(S)$ is well-defined and is the identity. Then, either σ is the identity $\text{id}_{A(S, P)}$ or σ is induced by a power τ^k of a Dehn twist around ∂S .*

Proof. Claim 1: There does not exist $[a] \in A(S)$ such that $\sigma| : f^{-1}([a]) \rightarrow f^{-1}([a])$ is a 1-translation.

By contradiction, let $[a] \in A(S)$ be such an element. Let us fix a hyperbolic metric on S such that the boundary of S is geodesic. Remember that any vertex of $A(S)$ has exactly one preferred geodesic representative in its isotopy class: geodesic representatives always intersect each other minimally and are always transverse to the boundary. Let \bar{a} be geodesic representative for $[a]$.

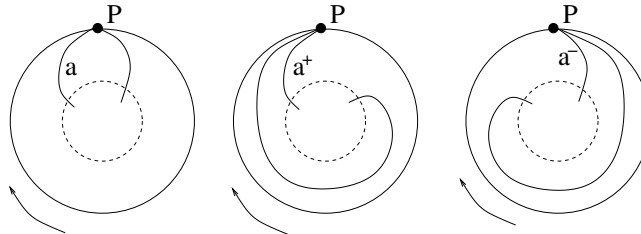

FIGURE 10. a, a^+, a^-

We can then define “preferred” classes $a, a^+, a^- \in A(S, P)$ just taking the relative isotopy classes of the loops obtaining joining the endpoints of \bar{a} to P as in Figure 10. Remark that

$\tau a^- = a^+$. Moreover, we can similarly define a “base point” b on every other fiber $f^{-1}([b])$, $[b] \in Lk([a], A(S))$ and describe completely the links between the fibers $f^{-1}([a])$ and $f^{-1}([b])$.

We have then 3 cases: Figures 11, 12, 13.

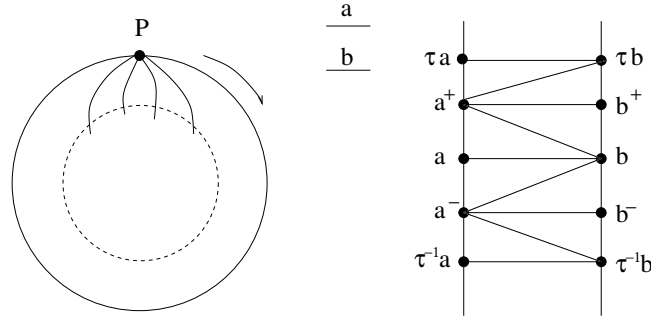

FIGURE 11. Case 1

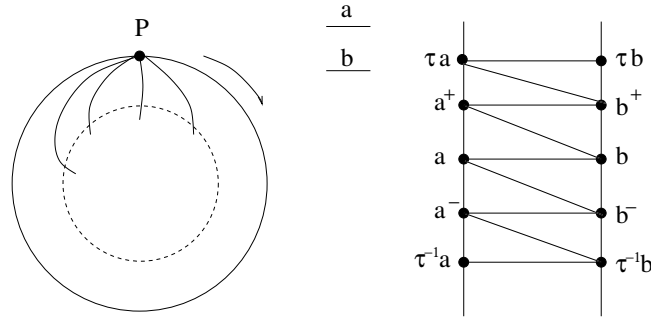

FIGURE 12. Case 2

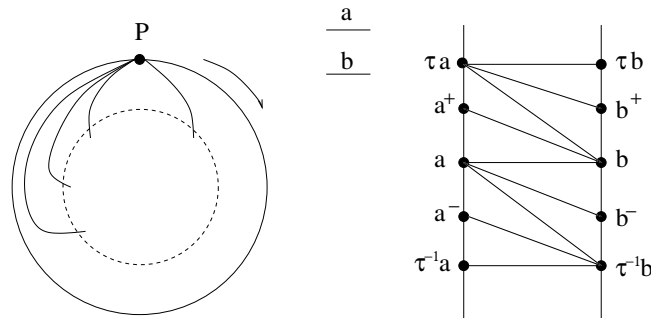

FIGURE 13. Case 3

Notice that in Case 1 we have $|Lk(a, A(S, P)) \cap f^{-1}([b])| = 1$ and $|Lk(a^\pm, A(S, P)) \cap f^{-1}([b])| = 3$. This is enough to prove Claim 1: for if σ restricts to a 1-translation on $f^{-1}([a])$, then $a \rightarrow a^\pm$ and $|Lk(a, A(S, P)) \cap f^{-1}([b])| = |Lk(\sigma(a), A(S, P)) \cap \sigma(f^{-1}([b]))| = |Lk(a^\pm, A(S, P)) \cap f^{-1}([b])|$.

Claim 2: There does not exist $[a] \in A(S)$ such that $\sigma| : f^{-1}([a]) \rightarrow f^{-1}([a])$ is a reflection.

We will prove the claim by contradiction. In the same setting of the proof of the previous claim, the simplicial definition of the reflection of $f^{-1}([a])$ is the following:

$$\rho_a : \begin{cases} a & \rightarrow a \\ a^- & \rightarrow \tau^{-1}a^- \\ \tau^k a & \rightarrow \tau^{-k}a & \text{for } k \in \mathbb{Z} \\ \tau^k a^- & \rightarrow \tau^{-k-1}a^- & \text{for } k \in \mathbb{N} \\ \dots & \end{cases}$$

Now assume that σ is a “global” extension for $\rho_a : f^{-1}([a]) \rightarrow f^{-1}([a])$. Recall from the proof of the previous claim that for every $[b] \in Lk([a], A(S, P))$ the fibers $f^{-1}([a])$ and $f^{-1}([b])$ can be linked in three different ways (Figures 11, 12, 13). It is not difficult to verify that:

- $\sigma| = \rho_b : f^{-1}([b]) \rightarrow f^{-1}([b])$ in Case 1;
- $\sigma| = \sigma_b \circ \rho_b : f^{-1}([b]) \rightarrow f^{-1}([b])$ in Case 2;
- $\sigma| = \sigma_b \circ \rho_b \circ \sigma_b^{-1} : f^{-1}([b]) \rightarrow f^{-1}([b])$ in Case 3.

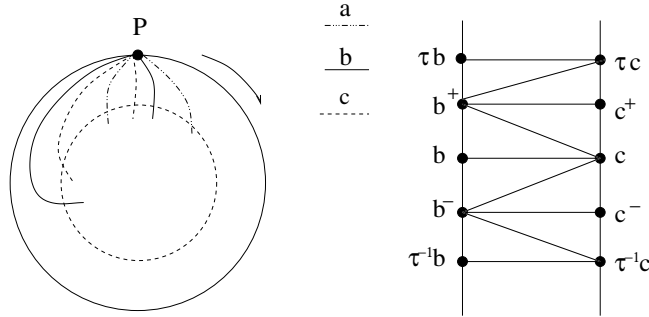

FIGURE 14. Simplicial relations between $f^{-1}([b])$ and $f^{-1}([c])$

Let now $[b], [c] \in A(S)$ such that $[a], [b], [c]$ is a triangle in $A(S)$ and they both are in Case 2. It is not difficult to verify that the simplicial relations between $f^{-1}([b])$ and $f^{-1}([c])$ (see Figure 14) are not compatible with the definitions of $\sigma| : f^{-1}([b]) \rightarrow f^{-1}([b])$ and $\sigma| : f^{-1}([c]) \rightarrow f^{-1}([c])$. Hence we have proved Claim 2.

By Claim 1 and 2, σ must coincide with some τ^{k_a} on each fiber $f^{-1}([a])$. The previous discussion about the connection between fibers $f^{-1}([a])$ and $f^{-1}([b])$ such that $[a]$ and $[b]$ span an edge on $A(S)$ and the connection of $A(S, P)$ proves that k_a is the same for all the fibers. \square

Lemma 3.7. *Let $g \geq 1$. If $\phi : A(S, P) \rightarrow A(S, P)$ is a simplicial automorphism, then $f(\phi) : A(S) \ni [a] \rightarrow f([\phi(a)]) \in A(S)$ is well-defined and it is an automorphism.*

Proof. Remark that if $\langle a, b \rangle$ is an edge of $A(S, P)$, then either $\langle f(a), f(b) \rangle$ is an edge in $A(S)$ or $f(a) = f(b)$ and $b = a^\pm \in f^{-1}([a])$ according to the above description of the fiber of $[a] \in A(S)$. Moreover if $\langle a_1, \dots, a_M \rangle$ is a maximal simplex in $A(S, P)$ (that is, if it corresponds to a triangulation of (S, P)) then the set $\{f(a_1), \dots, f(a_M)\}$ spans a maximal simplex in $A(S)$, and there are exactly two indices $i \neq j$ such that $f(a_i) = f(a_j)$ (that is $a_j = a_i^\pm$).

By contradiction now assume that there exists $\phi \in \text{Aut}A(S, P)$ such $f(\phi)$ is not well defined or simplicial. Hence, there are two cases:

- (1) there exists an edge $\langle a, b \rangle \in A(S, P)$ such that $\langle f(a), f(b) \rangle$ is an edge in $A(S)$, but $f(\phi(a)) = f(\phi(b)) \in A(S)$;
- (2) there exists an edge $\langle a, a^\pm \rangle \in A(S, P)$ such that $f(a) = f(a^\pm)$, $f(\phi(a^\pm)) \neq f(\phi(a))$ and $\langle f(\phi(a^\pm)), f(\phi(a)) \rangle$ is an edge in $A(S)$.

Claim 1: Let $\langle a, b \rangle$ be an edge of $A(S, P)$ as in the case 1. Then there does not exist $c \in A(S, P)$ such that $\langle a, b, c \rangle$ is a 2-simplex in $A(S, P)$, $\langle f(a), f(b), f(c) \rangle$ is a 2-simplex in $A(S)$ and $f(\phi(a)) = f(\phi(b)) = f(\phi(c))$.

By contradiction, let c be such a vertex, and let δ_{abc} be a maximal simplex in $A(S, P)$ which extends the 2-simplex $\langle a, b, c \rangle$. By simpliciality $\phi(\delta_{abc})$ is a maximal simplex in $A(S, P)$

which contains the simplex $\langle \phi(a), \phi(b), \phi(c) \rangle$, and $f(\phi(\delta_{abc}))$ spans a maximal simplex in $A(S)$. Then by the previous remark, at most two elements in the set $\{f(\phi(a)), f(\phi(b)), f(\phi(c))\}$ can coincide.

Claim 2: Let $\langle a, b \rangle$ be an edge as in the case 1. Then $\langle a, a^\pm \rangle$ spans an edge of $A(S, P)$ as in the case 2.

Consider the 2-simplex $\langle a, a^\pm, b \rangle$ and extend it to a maximal simplex $\delta_{aa^\pm b}$ of $A(S, P)$. Notice that $\phi(\delta_{aa^\pm b})$ is a maximal simplex of $A(S, P)$, and by the above remark exactly two of its vertices must have the same image through f . Now by hypothesis $f(\phi(a)) = f(\phi(b))$, then necessarily $f(\phi(a)) \neq f(\phi(a^\pm))$, and $\langle a, a^\pm \rangle$ is an edge of $A(S, P)$ in the case 2.

Claim 3: Let $\langle a, a^\pm \rangle$ be an edge in the case 2, and let δ_{aa^\pm} be a maximal simplex of $A(S, P)$ extending it. Then δ_{aa^\pm} contains a unique vertex b^δ such that $\langle a, b^\delta \rangle$ is an edge in the case 1.

By simpliciality $\phi(\delta_{aa^\pm})$ is a maximal simplex in $A(S, P)$. By hypothesis, $f(\phi(a)) \neq f(\phi(a^\pm))$, then by the above remark there exists $b \in \delta_{aa^\pm}$ such that $f(\phi(b)) = f(\phi(a))$. Now $f(a) = f(a^\pm)$, then by Claim 1 necessarily $f(b) \neq f(a)$. The unicity of b follows from the same argument.

WLOG we can assume that $\langle a, a^+ \rangle$ is an edge as in the case 2 (Claim 2 guarantees that such an edge exists).

In the genus 1 case the proof is direct. Remark that in $(S_{1,1,0}, (1))$ there is only one orbit of arcs though the action of the mapping class group. Up to precomposing with a simplicial automorphism induced by a mapping class, we can assume $\phi(a) = a$. The map ϕ restricts to a simplicial automorphism of the annulus $(S_{0,2,0}, (1, 2))$ obtained by cutting S along a . We remark that the two arcs a^+ and a^- correspond to the two 2-leaves of the annulus. By Lemma 2.18, ϕ preserves the set of 2-leaves, hence $\phi(a^+) \in \{a^+, a^-\}$ and $f(\phi(a^+)) = f(a)$, we get to a contradiction.

Let us now focus on the case $g \geq 2$. Let $\delta_{aa^+}^1$ be a maximal simplex of $A(S, P)$ extending $\langle a, a^+ \rangle$. Let b^1 be the unique vertex in $\delta_{aa^+}^1$ as in the Claim 3. Now flip $\delta_{aa^+}^1$ on b^1 , and let $\delta_{aa^+}^2$ be the new triangulation and b^2 be the new side. By Claims 1 and 3 the edge $\langle a, b^2 \rangle$ is necessarily as in the case 1. Now since $g \geq 2$ the situation looks like in Figure 15 and b^2 bounds

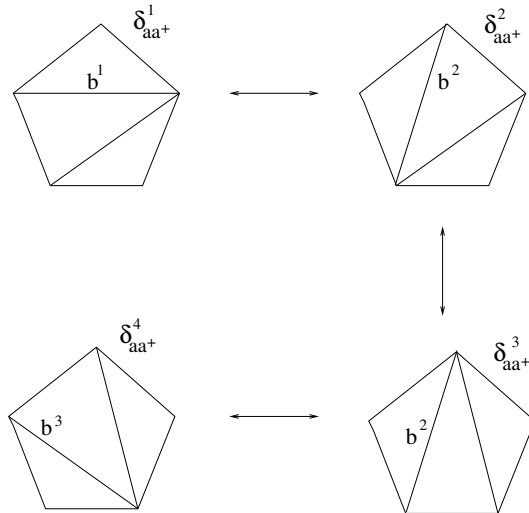

FIGURE 15

a triangle on (S, P) where at least one of the other two sides is neither a nor a^+ . Performing another flip on that arc, we find another maximal simplex $\delta_{aa^+}^3$ still containing a, a^+ and b^2 . Now flipping again on b^2 , we obtain a new maximal simplex $\delta_{aa^+}^4$ containing a, a^+ and a new

arc b^3 (not contained in $\delta_{aa^+}^3$). By Claim 1 and 3, the edge $\langle a, b^3 \rangle$ is in the case 1, and $\langle b^1, a, b^3 \rangle$ spans a 2-simplex (see again 15), but this contradicts Claim 1. \square

We can summarize the results of the previous lemmas in the following proposition.

Proposition 3.8. *The forgetful map $f : A(S, P) \rightarrow A(S)$ induces an homomorphism $f_* : \text{Aut}A(S, P) \rightarrow A(S)$ whose kernel is generated by Dehn twists around ∂S .*

3.2.2. *Proof of Theorem A for $b = 1$.* Let us now complete the proof of Theorem A for surfaces with one boundary component. We will prove another Reduction Lemma, which will be used together with Reduction Lemma as a key ingredient in our proof.

Reduction Lemma 2. *Let $S_{g,1}^0$ be a surface of genus $g \geq 1$ with 1 boundary component. If $A(S_{g,1}^0)$ is almost-rigid, then also $A(S_{g,1,0}, P)$ is almost-rigid.*

Proof. Let $\phi \in \text{Aut}(A(S_{g,1}^0, P))$ be an automorphism. By Lemma 3.7 $f(\phi) \in \text{Aut}(A(S_{g,1}))$, and by hypothesis there exists a mapping class $\text{MCG}^*(S_{g,1})$ which induces ϕ . Let $\bar{\phi} : (S, P) \rightarrow (S, P)$ an homeomorphism in such class and let $\bar{\phi}_* : A(S, P) \rightarrow A(S, P)$ be the induced map. We have that $\text{id} = f(\bar{\phi}_*^{-1} \circ \phi) : A(S_{g,1}) \rightarrow A(S_{g,1})$, then there exists $k \in \mathbb{Z}$ such that $\bar{\phi}_*^{-1} \circ \phi = \tau_*^k$, hence ϕ is induced by $\phi \circ \tau^k$. \square

The following proposition can be also regarded as a particular case of a theorem of Irmak and McCarthy [5]. We will postpone our proof to the last section.

Proposition 3.9. *If $S_{g,1}^0$ is a compact orientable surface of genus $g \geq 2$ with one boundary component, then the natural homomorphism $\text{MCG}^*(S_{g,1}^0) \rightarrow \text{Aut}(A(S_{g,1}^0))$ is surjective.*

An easy application of Lemma 2 and the previous proposition proves the following:

Proposition 3.10. *Let $(S_{g,1}^0, (n))$ be a surface of genus $g \geq 1$ with one boundary component and n marked points on it. Then $A(S_{g,1}^0, (n))$ is almost-rigid.*

Proof. The case $n = 1$ easily follows from an application of Lemma 2.

Now let us use an inductive argument. By Lemma 2.19, we can assume that ϕ fixes every 3-petal (or 2-leaf). Let v be a 3-petal (or 2-leaf), cutting S along v we find two surfaces $(S_{g,1}^0, (1))$ and $(S_{0,1}^0, (3))$, and ϕ induces an automorphism ϕ_1 of the arc complex of $(S_{g,1}^0, (n-1))$. By induction ϕ_1 is induced by a homeomorphism ϕ_1 of $(S_{g,1}^0, (n-1))$ which fixes every point on the boundary. Lemma 2.10 ensures that the homeomorphism obtained by glueing ϕ_1 to a suitable homeomorphism of $(S_{0,1}^0, (3))$ induces ϕ on the whole $A(S_{g,1}^0, (n))$. \square

As an immediate application of Propositions 3.10 and 3.2.2, we have:

Theorem A (Case $b = 1$). *Let $(S_{g,1}^s, (1))$ be an orientable surface of genus $g \geq 1$. Then $A(S_{g,1}^s, (1))$ is almost-rigid.*

3.2.3. *Proof of Proposition 3.9.* In this section we will use Lemma 2 to give an independent proof of Proposition 3.9.

Lemma 3.11. *Let $S_{g,0,1}$ be a closed orientable surface of genus $g \geq 2$ with one puncture P . Let $c \in A(S_{g,1})$ be a vertex corresponding to a separating arc, which separates S in two connected components $S = S'_c \cup S''_c$.*

For any $\phi \in \text{Aut}(A(S_{g,0,1}))$ $\phi(c)$ corresponds to an arc which separates S in two connected components $S = S'_{\phi(c)} \cup S''_{\phi(c)}$, with $S'_{\phi(c)}$ homeomorphic to S'_c and $S''_{\phi(c)}$ homeomorphic to S''_c . Moreover, ϕ restricts to isomorphisms $\phi_1 : A(S'_c, P) \rightarrow A(S'_{\phi(c)}, P)$ and $\phi_1 : A(S''_c, P) \rightarrow A(S''_{\phi(c)}, P)$.

Proof. By simpliciality, $Lk(c, A(S_{g,0,1})) = A(S'_c, P) \star A(S''_c, P) \cong Lk(\phi(c), A(S_{g,0,1}))$ has diameter 2. If $\phi(c)$ were non-separating, then $Lk(\phi(c), A(S_{g,0,1})) \cong A(S_{g-1,2,0}, (1, 1))$ has infinite diameter. Thus, $\phi(c)$ separates S into two connected components $S'_{\phi(c)}$ and $S''_{\phi(c)}$. We also remark that in this setting the following conditions are equivalent:

- (1) $S'_{\phi(c)}, S''_{\phi(c)}$ are respectively homeomorphic to S'_c, S''_c ;
- (2) $(\text{genus}(S'_{\phi(c)}), \text{genus}(S''_{\phi(c)})) = (\text{genus}(S'_c), \text{genus}(S''_c))$;
- (3) $\dim A(S'_c, P) = \dim A(S'_{\phi(c)}, P)$
- (4) the number of arcs of a triangulation of S'_c is equal to the number of arcs of a triangulation of $S'_{\phi(c)}$.

Without loss of generality, we assume $g(S'_c) = \max\{g(S'_c), g(S''_c), g(S'_{\phi(c)}), g(S''_{\phi(c)})\}$. Let μ_c be a maximal simplex in $A(S'_c, P)$, that is $\dim \mu_c = \dim \text{Lk}(c, A(S))$. Let $\mathcal{S}(\mu_c)$ be the set of simplices of $\text{Lk}(c, A(S))$ obtained from μ_c by an elementary move. Since μ_c corresponds to a triangulation of S'_c , it holds $|\mathcal{S}(\mu_c)| = \dim \mu_c + 1 = \dim A(S'_c, P) + 1$. By simpliciality, $\phi(\mathcal{S}(\mu_c))$ corresponds precisely to the set of simplices in $\text{Lk}(\phi(c), A(S))$ obtained from $\phi(\mu_c)$ by an elementary move, and it holds $|\phi(\mathcal{S}(\mu_c))| = |\mathcal{S}(\mu_c)|$. We write $\phi(\mu_c)$ as $\phi(\mu_c) = \langle \mu'_{\phi(c)}, \mu''_{\phi(c)} \rangle$, where $\mu'_{\phi(c)}$ (resp. $\mu''_{\phi(c)}$) is either the empty set or a simplex in $A(S'_{\phi(c)}, P)$ (resp. $A(S''_{\phi(c)}, P)$), and we remark that $\dim \mu'_{\phi(c)} + \dim \mu''_{\phi(c)} + 2 = \dim \phi(\mu_c) + 1 = \dim \mu_c + 1 = \dim A(S'_c, P) + 1 = |\mathcal{S}(\mu_c)|$.

By contradiction assume that $0 \leq \dim \mu'_{\phi(c)} < \dim A(S'_{\phi(c)}, P)$, that is $\mu'_{\phi(c)}$ is non empty nor a triangulation of $(S'_{\phi(c)}, P)$. Since $g \geq 2$, there are at least two different ways to extend $\mu'_{\phi(c)}$

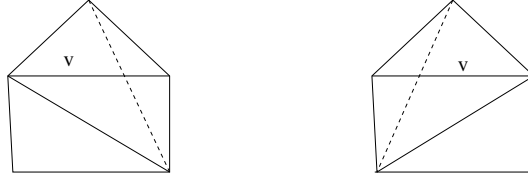

FIGURE 16. Two ways of flipping v in $\mu'_{\phi(c)}$

to a triangulation of $S'_{\phi(c)}$ and, since $(S'_{\phi(c)}, P)$ has only one boundary component, there exists at least one vertex of $\mu'_{\phi(c)}$ flippable in at least two different ways (see Figure 16). It follows that $|\mathcal{S}(\phi(\mu_c))| \geq \dim \mu''_{\phi(c)} + 1 + \dim \mu'_{\phi(c)} + 2 > |\mathcal{S}(\mu_c)|$, and we get to a contradiction. The same argument holds if we assume $0 \leq \dim \mu''_{\phi(c)} < \dim A(S''_{\phi(c)}, P)$.

We deduce that either $\dim \mu'_{\phi(c)} = \dim A(S'_{\phi(c)}, P)$ (and $\mu''_{\phi(c)} = \emptyset$) or $\dim \mu''_{\phi(c)} = \dim A(S''_{\phi(c)}, P)$ (and $\mu'_{\phi(c)} = \emptyset$). In the first case $\phi(\mu_c) = \phi(\mu'_c) \subset A(S'_c, P)$ has maximal dimension, similarly in the second case $\phi(\mu_c) = \phi(\mu''_c) \subset A(S''_c, P)$ has maximal dimension. The conclusion easily follows from the equivalence of the above conditions 1 and 2. \square

This lemma actually gives an independent proof of Proposition 3.9:

Proposition 3.12. *Let $S^1_{g,0}$ be an oriented surface of genus $g \geq 1$ with one marked point P . Then the natural representation $\text{MCG}^*(S^1_{g,0}) \rightarrow \text{Aut}(A(S^1_{g,0}))$ is surjective.*

Proof. We recall that this result is well known for $g = 1$.

Let $\phi \in \text{Aut}A(S^1_{g,0})$ be a simplicial automorphism, and let $c \in A(S^1_{g,0})$ be an arc which separates S in two subsurfaces $(S^0_{1,1}, P)$ of genus 1 and $(S^0_{g_2,1}, P)$ of genus $g_2 \geq 1$. Up to precompose ϕ with an automorphism induced by $\text{MCG}^*(S^1_{g,0})$, we can assume $\phi(c) = c$, and ϕ restricts to automorphisms ϕ_1 and ϕ_2 , respectively on $A(S^0_{1,1}, P)$ and $A(S^0_{g_2,1}, P)$. By the genus 1 case, ϕ_1 is induced by a homeomorphism $f_1 : (S^0_{1,1}, P) \rightarrow (S^0_{1,1}, P)$. If also $g_2 = 1$, let $f_2 : (S^0_{1,1}, P) \rightarrow (S^0_{1,1}, P)$ be the homeomorphism which induces ϕ_2 . We conclude just glueing it to f_1 , the resulting homeomorphism $f : S^1_{1,0} \rightarrow S^1_{1,0}$ induces ϕ . $\bar{g}_2 \geq 1$. An inductive argument on g_2 allows us to conclude: if the statement holds for \bar{g}_2 , then by Lemma 2 the homomorphism $\text{MCG}^*(S^1_{\bar{g}_2}, P) \rightarrow \text{Aut}A(S^1_{\bar{g}_2}, P)$ is surjective, and ϕ_2 is induced by a homeomorphism $f_2 : (S^0_{\bar{g}_2,1}, P) \rightarrow (S^0_{\bar{g}_2,1}, P)$, which can be glued to f_1 to give an homeomorphism of the surface inducing ϕ . \square

3.2.4. *Complement.* Here we complete our proof with the $b = 0$ case. The following lemma can be proved with the same argument as Proposition 3.12.

Lemma 3.13. *Let $S_{g,0}^{s+1}$ be a compact orientable surface of genus $g \geq 2$ with $s + 1$ marked points. Let $c_1 \in A(S_{g,0}^{s+1})$ be a vertex corresponding to a separating arc who decomposes S as $S = S'_{c_1} \cup S''_{c_1}$ where $S'_{c_1} = (S_{g'+1,1}^0, (1))$ and $S''_{c_1} = (S_{g''+1,1}^s, (1))$.*

For any $\phi \in \text{Aut}(A(S_{g,s+1}))$ $\phi(c_1)$ is a separating arc whose induced decomposition is $S = S'_{\phi(c_1)} \cup S''_{\phi(c_1)}$, with $S'_{\phi(c_1)}$ homeomorphic to S'_{c_1} and $S''_{\phi(c_1)}$ homeomorphic to S''_{c_1} . Moreover, ϕ induces isomorphisms $\phi|_1 : A(S'_{c_1}, P) \rightarrow \phi(A(S'_{c_1}, P)) = A(S'_{\phi(c_1)}, P)$ and $\phi|_2 : A(S''_{c_1}, P) \rightarrow \phi(A(S''_{c_1}, P)) = A(S''_{\phi(c_1)}, P)$ by restriction.

Theorem 3.14. *Let $S_{g,0}^s$ be an orientable surface of genus $g \geq 2$ with $s \geq 1$ punctures. Then the natural homomorphism $\text{MCG}^*(S_{g,0}^s) \rightarrow \text{Aut}A(S_{g,0}^s)$ is surjective.*

Proof. Let $\phi \in \text{Aut}(S_{g,s})$ and let c be a simple closed loop based at the puncture P on S such that c disconnects the surface into the two subsurfaces $(S_{1,1,s-1}, P)$ (of genus 1) and $(S_{g_2,1,0}, P)$ (of genus $g_2 \geq 1$). By Lemma 3.13, up to precomposition with an element of the mapping class group, ϕ restricts to automorphisms of $A(S_{1,1,s-1}, P)$ and $A(S_{g_2,1,0}, P)$. Hence, by Proposition 3.10 in the genus 1 case, Proposition 3.12 and Lemma 2 both automorphisms are induced by homeomorphisms of the respective surfaces. Glueing them, we get an homeomorphism of S which induces ϕ by Lemma 2.9. \square

An analogous version of Theorem 3.14 in the slightly different context of injective simplicial maps and arc complexes of surfaces with boundary (and no marked points) has also been achieved by Irmak and Mc Carthy. Their proof is based on an extensive study of all the possible reciprocal configurations of quintuplets of arcs connecting two boundary components (see [5]).

4. PROOF OF THEOREM A

In the following we shall denote by $(S_{g,b}^s, \mathbf{p})$ a surface of genus $g \geq 1$, with s marked points, b enumerated boundary components and $\mathbf{p} = (p_1, \dots, p_b)$ is the vector whose i -th component p_i is the number of marked points on the i -th boundary component. Also recall that $\dim A(S_{g,b}^s, \mathbf{p}) = 6g + 3b + 3s + |\mathbf{p}| - 7$. When $p_i = 1$ for all $i = 1, \dots, b$, we will use the notation (1_b) to refer to the vector \mathbf{p} .

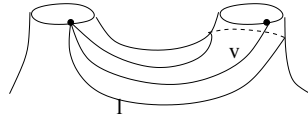

FIGURE 17

Invariance Lemma 4.1. *Let $\langle l, v \rangle$ be an edge of $\text{Aut}(A(S_{g,b}^s, \mathbf{1}))$ such that v corresponds to a non-separating arc connecting two distinct boundary component and l corresponds to a separating loop wrapping around v as in Figure 17. Then $\phi(\langle l, v \rangle)$ is an edge of the same kind.*

Proof. Let $\phi \in \text{Aut}(A(S_{g,b}^s, \mathbf{1}))$ be an automorphism. We remark that $Lk(l) \cong \mathbb{R} \star A(S_{g,b}^s, (2, 1_{b-1}))$, where v is a vertex of \mathbb{R} . By Statement 2 of Lemma 2.15 $\phi(l)$ has the same property and $\phi(v)$ is a vertex of \mathbb{R} . \square

Reduction Lemma 3. *If $A(S_{g,b}^s, \mathbf{1})$ is almost-rigid, then for every $\mathbf{p} = (p_1, \dots, p_b) \in \mathbb{N}_0^b$ $A(S_{g,b}^s, \mathbf{p})$ is almost-rigid.*

Proof. By an inductive argument it is sufficient to show that the surjectivity of $\text{MCG}^*(S_{g,b}^s, (p_1 - 1, \dots, p_b)) \rightarrow \text{Aut}(A(S_{g,b}^s, (p_1 - 1, \dots, p_b)))$ implies the surjectivity of $\text{MCG}^*(S_{g,b}^s, (p_1 - 1, \dots, p_b)) \rightarrow \text{Aut}(A(S_{g,b}^s, \mathbf{p}))$. Let $\phi \in \text{Aut}(A(S_{g,b}^s, \mathbf{1}))$ be an automorphism.

Assume first that $p_1 \geq 3$. By Lemma 2.16 we can assume that ϕ fixes every 3-petal (or 3-leaf) on the first boundary component, up to precomposition with an automorphism induced by an element of the mapping class group. Let v_1, v_2 be two 3-petals such that $i(v_1, v_2) = 0$. Let us cut along v_1 , ϕ induces an automorphism ϕ_1 of the arc complex of the surface $(S_{g,b}^s, (p_1 - 1, \dots, p_b))$ obtained cutting along v_1 . Our hypothesis implies that ϕ_1 is induced by a homeomorphism $\tilde{\phi}_1$ of $(S_{g,b}^s, (p_1 - 1, \dots, p_b))$. Since $\tilde{\phi}_1(v_2) = v_2$, $\tilde{\phi}_1$ is the identity on the boundary of its first component, it agrees with the identity on $(S_{0,1}^0, (3))$ and, by gluing, it gives a homeomorphism on $(S_{g,b}^s, \mathbf{p})$ which induces ϕ . Lemma 2.18 ensures us that the same argument holds for $p_i = 2$ using 2-leaves instead of 3-petals. \square

Reduction Lemma 4. *Let $b \geq 2$. If $A(S_{g,b-1}^s, \mathbf{1})$ is almost-rigid, then $A(S_{g,b}^s, \mathbf{1})$ is almost-rigid.*

Proof. Let $\langle l, v \rangle$ be an edge as in Lemma 4.1. WLOG assume l is based on the first boundary component and v joins the first and the second boundary component. Let $\phi \in \text{Aut}(A(S_{g,b}^s, \mathbf{1}))$ be an automorphism. Up to precomposition with an element induced by a mapping class, we can assume $\phi(l) = l$ and $\phi(v) = v$. Cutting along v , we have that ϕ restricts to an automorphism ϕ_1 of the arc complex of the surface $(S_{g,b-1}^s, (4, 1_{b-2}))$. Our hypothesis and Lemma 3 imply that ϕ_1 is induced by a homeomorphism $\tilde{\phi}_1 : (S_{g,b-1}^s, (4, 1_{b-2})) \rightarrow (S_{g,b-1}^s, (4, 1_{b-2}))$. Since $\tilde{\phi}_1(l) = l$, ϕ preserves the segment of the first boundary components of $(S_{g,b-1}^s, (4, 1_{b-2}))$ which correspond to the cut along v , we can thus glue back and get a homeomorphism of $(S_{g,b}^s, \mathbf{1})$. \square

Combining the previous lemmas, Proposition 3.2.2 and $g = 0$ cases, we deduce the following:

Theorem A (Geometricity). *Let $(S_{g,b}^s, \mathbf{p})$ be an orientable surface of genus $g \geq 1$ with s marked points in the interior, b enumerated boundary components, and let $\mathbf{p} = (p_1, \dots, p_b)$ be the vector whose i -th component p_i is the number of marked points on the i -th boundary component of S . Then $A(S_{g,b}^s, \mathbf{p})$ is almost-rigid.*

5. PROOF OF THEOREM B

By sake of brevity, we shall use the notation $A_{\#}$ for $A_{\#}(S_{g,b}^s, \mathbf{p})$ and A for $A(S_{g,b}^s, \mathbf{p})$. In order to prove Theorem B, we shall first prove that any $\phi : A_{\#}(S_{g,b}^s, \mathbf{p}) \rightarrow A_{\#}(S_{g,b}^s, \mathbf{p})$ automorphism extends to $\tilde{\phi} : A(S_{g,b}^s, \mathbf{p}) \rightarrow A(S_{g,b}^s, \mathbf{p})$.

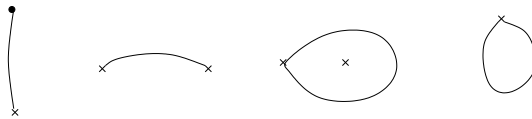

FIGURE 18

Step 1: Extending ϕ on the vertices of A .

We shall define an extension $\tilde{\phi}$ of ϕ on A_0 . We classify the vertices of $A \setminus A_{\#}$ in 4 types, as in Figure 18: arcs α joining a marked point on the boundary to a puncture inside, arcs β joining two punctures, loops γ based at a puncture wrapping around another puncture, loops δ based on a puncture (different from type γ).

Let α be an arc joining a marked point on the boundary to a puncture inside, and let us complete α to the edge-drop $\langle \alpha, l_{\alpha} \rangle$ (we can do it in a unique way). By Lemma 2.13, $\phi(l_{\alpha})$ is an arc of the same type. Hence, we can define $\tilde{\phi}(\alpha)$ as the unique complement of $\phi(l_{\alpha})$ to an edge-drop in A .

The following lemma is an easy consequence of Lemmas 2.14 and 2.15.

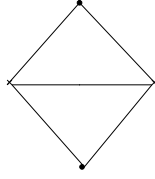

FIGURE 19

Lemma 5.1. *The configuration of arcs in a square like in Figure 19 is invariant through the action of ϕ (and $\tilde{\phi}$, above defined).*

Let $\beta \in A$ be an arc joining two punctures. Let us choose vertices $v_1, \dots, v_4 \in A$ disjoint arcs as in the case above, such that they form a square on S whose diagonal is β (as in Figure 19). Let us denote by β^* the other diagonal of this square, and remark that $\beta^* \in A_{\sharp}$. By Lemma 5.1, the arcs $\tilde{\phi}(v_1), \dots, \tilde{\phi}(v_4)$ form a square with diagonal $\phi(\beta^*)$. Let us then define $\tilde{\phi}(\beta) := \phi(\beta^*)^*$, the other diagonal of this new square. We remark that at this step this definition depends only the choice of v_1, \dots, v_4 . We shall see later that it is actually natural.

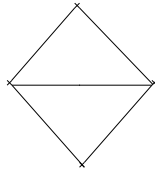

FIGURE 20

Lemma 5.2. *The configuration of arcs in a square joining punctures in a square like Figure 20 is invariant through the action of ϕ (and $\tilde{\phi}$, as above defined).*

Let γ be a loop around β , and let α be one of the arcs not intersecting γ used in the definition of $\tilde{\phi}(\beta)$. By definition, $\tilde{\phi}(\beta)$ (resp. $\tilde{\phi}(\alpha)$) is an arc of the same type of β (resp. α), and by the above lemma $\tilde{\phi}(\alpha)$ and $\tilde{\phi}(\beta)$ share a (unique) common endpoint.

We can thus define $\tilde{\phi}(\gamma)$ as the loop based at this end and running close around $\tilde{\phi}(\beta)$. We remark that this definition depends only on the one of $\tilde{\phi}(\beta)$. Let γ be a loop based at a puncture. Let

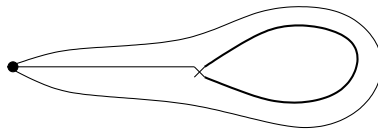

FIGURE 21

us choose α_γ an arc disjoint from γ which connects the puncture to a marked point on the boundary, and let l_γ the loop boundary of $\alpha_\gamma \cup \gamma$ as in Figure 21. As in lemmas above, it is not difficult to prove that the relative configuration of $\alpha_\gamma \cup l_\gamma$ is invariant through the action of $\tilde{\phi}$. We can then define $\tilde{\phi}(\gamma)$ as the loop parallel to $\phi(l_\gamma)$ based at the top point of $\tilde{\phi}(\alpha_\gamma)$. We remark that this definition depends only on the choice of α_γ .

Step 2: Simpliciality of $\tilde{\phi}$ We can resume the remarks used above in the following Invariance Lemma. The prove easily follows from lemmas above, Lemmas 2.13, 2.15.

Lemma 5.3. *The maps ϕ and $\tilde{\phi}$ preserve squares and their diagonals.*

It is not difficult to see that $\tilde{\phi}$ is simplicial if and only if for any maximal simplex T in A $\tilde{\phi}(T)$ is a maximal simplex as well. For any T_{\sharp} maximal simplex in A_{\sharp} , there is a natural way to

extend T_{\sharp} to a maximal simplex \tilde{T}_{\sharp} by adding arcs of type α as above. By definition of $\tilde{\phi}$, the simultaneous disjointness of all such arcs is preserved in this case, and \tilde{T}_{\sharp} is a maximal simplex in A as well. To prove the statement in full generality, just recall that any two triangulations of A are connected by flips and Lemma 5.3 ensures us that simpliciality is preserved through flips.

Step 3: Surjectivity of $\tilde{\phi}$. We remark that $\tilde{\phi}$ preserves the types of arcs in Figure 18, moreover it is clearly surjective on arcs α . Surjectivity on arcs γ clearly follow from surjectivity on arcs β . Surjectivity on β and δ follows from Lemma 5.3. Let w be such an arc, there exists a square (whose sides v_1, \dots, v_4 are arcs of type α) on S having w as a diagonal (see for instance Figure 19 for β). By surjectivity on sides of type α , $v_i = \tilde{\phi}(u_i)$. By Lemma 5.3, u_1, \dots, u_4 is a square as well and its diagonals are the preimages of diagonals of the v_1, \dots, v_4 .

Step 4: Injectivity of $\tilde{\phi}$.

Injectivity on arcs of type α follows by definition, injectivity on arcs of type β and γ follows by construction. Imagine $\tilde{\phi}(\delta_1) = \tilde{\phi}(\delta_2)$.

Step 5: Well definition By the above steps, we have that all the possible extensions $\tilde{\phi}$ are automorphisms of A . By the remark in Step 2, the maps are all canonically determined on a triangulation \tilde{T}_{\sharp} . Hence, by Lemma 2.9, they all coincide and the definition of $\tilde{\phi}$ doesn't depend on any choice.

To conclude the proof, let us just remark that the restriction map $\beta : \text{Aut}A \rightarrow \text{Aut}A_{\sharp}$ defined as $\beta(\phi) := \phi|_{A_{\sharp}}$ is well- defined and is a group homomorphism, and so is $\alpha : \text{Aut}A_{\sharp} \rightarrow \text{Aut}A$ defined as $\alpha(\phi) := \tilde{\phi} \circ \phi$. Moreover $\alpha \circ \beta = id_{\text{Aut}A}$ and $\beta \circ \alpha = id_{\text{Aut}A_{\sharp}}$, hence $\text{Aut}A_{\sharp} \cong \text{Aut}A$. Theorem A concludes the following.

Theorem B. *Let $(S_{g,b}^s, \mathbf{p})$ be an orientable surface of genus g with $b \geq 1$ boundary components, s punctures and $p_i \geq 1$ for all $i = 1, \dots, b$.*

If $(S_{g,b}^s, \mathbf{p}) \neq (S_{0,2}^0, (1, 1))$, then $A_{\sharp}(S_{g,b}^s, \mathbf{p})$ is rigid. Moreover, the natural homomorphism $\text{MCG}(S_{0,2}^0, (1, 1)) \rightarrow \text{Aut}A_{\sharp}(S_{0,2}^0, (1, 1))$ is surjective, but not injective.

Acknowledgements I would like to thank my advisor Athanase Papadopoulos for proposing me this problem as well as for his corrections on the earlier versions of this draft.

REFERENCES

- [1] H. Bowditch, D. B. A. Epstein, Natural triangulations associated to a surface. *Topology* 27 (1988), no. 1, 91117.
- [2] B. Braun, R. Ehrenborg, The Complex of Non-Crossing Diagonals of a Polygon, *Journal of Combinatorial Theory Series A* Volume 117, Issue 6 (2010), 642-649
- [3] L. Harer, The virtual cohomological dimension of the mapping class group of an orientable surface. *Invent. Math.* 84 (1986), no. 1, 157176.
- [4] Munkres, *Elements of algebraic topology*, Addison-Wesley Publishing Company, Menlo Park, Calif., 1984
- [5] Irmak, McCarthy, Injective simplicial maps of the arc complex, *Turk. J. Math.* 34, (2010), 339 - 354
- [6] M. Korkmaz, Automorphisms of complexes of curves on punctured spheres and on punctured tori, *Top. Appl.* 95 (1999), no. 2, 85-111
- [7] N. Ivanov, Mapping class groups, in *Handbook of geometric topology*, 523-633 North- Holland, Amsterdam, 2002.
- [8] N. Ivanov, Automorphisms of complexes of curves and of Teichmüller spaces, *IMRN* 14 (1997), 651 - 666
- [9] F. Luo, Automorphisms of the curve complexes, *Topology*, Volume 39 (2000), Issue 2, 283-298
- [10] McCarthy, Papadopoulos, Simplicial actions of the mapping class groups, *Handbook of Teichmüller theory* vol. IV, EMS (2012)
- [11] R. C. Penner, Probing mapping class groups through arcs in "Problems on the mapping class groups and related topics", *Proceedings of Symposia in Pure Mathematics* 74, AMS
- [12] R. C. Penner, The structure and singularities of quotient arc complexes, *Journal of Topology* 1 - 3 (2008), 527 - 554
- [13] R. C. Penner, *Decorated Teichmüller theory*, EMS (2012)
- [14] R. C. Penner, The simplicial compactification of Riemann's moduli space, *Proceedings of the 37th Taniguchi Symposium* (World Scientific, 1996), 237-252

- [15] R. C. Penner, Decorated Teichmüller space of punctured surfaces, *Comm. Math. Phys.* Volume 113, Number 2 (1987), 299-339.