



HAL
open science

Modélisation méthodes et structuration des données induites pour les codes de simulation

Harry Boyer, Jean-Claude Gatina, Florence Pignolet, Jean Brau

► **To cite this version:**

Harry Boyer, Jean-Claude Gatina, Florence Pignolet, Jean Brau. Modélisation méthodes et structuration des données induites pour les codes de simulation. Ciss: First Joint Conference of International Simulation Societies, 1994, Aug 1994, Zurich, Switzerland. pp.729-733. hal-00768193

HAL Id: hal-00768193

<https://hal.science/hal-00768193>

Submitted on 21 Dec 2012

HAL is a multi-disciplinary open access archive for the deposit and dissemination of scientific research documents, whether they are published or not. The documents may come from teaching and research institutions in France or abroad, or from public or private research centers.

L'archive ouverte pluridisciplinaire **HAL**, est destinée au dépôt et à la diffusion de documents scientifiques de niveau recherche, publiés ou non, émanant des établissements d'enseignement et de recherche français ou étrangers, des laboratoires publics ou privés.

MODELISATION METHODS AND DATA STRUCTURATION INDUCED FOR BUILDING THERMAL SIMULATION CODES

Harry BOYER, Jean Claude GATINA, Florence PIGNOLET
Université de la Réunion, Faculté des Sciences,
Laboratoire de Génie Industriel,
BP 7151 - 15, rue René Cassin
97715 Saint-Denis Cedex messag. 09
Ile de la Réunion- FRANCE
E. mail : boyer@helios.univ-reunion.fr

Jean BRAU
Institut National des Sciences Appliquées
Equipe Equipement de l'Habitat, CETHIL
Bât. 307, 20 avenue Albert Einstein
69621 Villeurbanne Cedex, FRANCE

Abstract : Two main modelisation techniques are the analytic and systemic methods. After a presentation of each method applied to building simulation, this paper emphasizes the benefit of systemic modelisation for multizone cases. Using a conceptual description of a building issued of previous method, one particular sub-system appears naturally, i.e. the thermal zones. Then, one of the simulationist's problem, the physical coupling of thermal zones, can simply be solved and in a very modular manner. Building description through data structures, required for thermal design, is easily reached. Then, the detail of our datas' organisation is given in the case of our multiple model software, CODYRUN.

At the beginning of this work, our objective was to realize a design tool suitable for professionals and usable by researchers. More precisely, *CODYRUN* is a multizone software integrating both natural ventilation and moisture transfers. During a simulation, one of its most interesting aspects is to offer the expert thermician a wide range of choices between different heat transfer models and meteorological reconstitution parameters models. The aim may be to realize studies of the software sensitivity to these different models, in order to choose those that should be integrated in a suitable conception tool. It was developed on a PC micro computer with Microsoft WINDOWS user-friendliness interface.

Considering the thermal behaviour of a building, its thermal state is determined by the continuous field of temperatures, concerning all points included in the physical limits of the building.

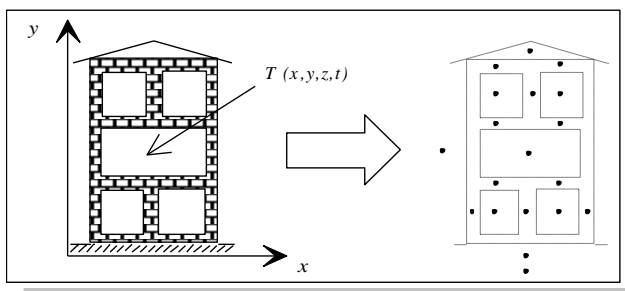

Fig. 1 : Thermal discretisation of a building

The constitution of a reduced model (fig. 1) is possible by assuming some simplifications, as mono-

dimensional conduction in walls or well mixed air volumes of each thermal zone.

1) Analytic method in building simulation :

As in other fields, computer simulations and before modelisation methods became key words. History of modelisation shows the domination of the analytic methods. This procedure means that it's possible to reduce the studied object into elementary parts and that it's possible to rebuild the object from these parts. So, the building system is considered as split up into simple systems, like walls, windows, air volumes, HVAC systems,Then, it's necessary to study them one by one and to understand the existing interactions.

Considering a wall, the thermal field expresses the instanted balance between conduction, convection and radiation heat transfers. For each of these phenomena, analytic models are available and their assembly will build a wall thermal model. For conduction transfers, inputs for each side of the wall (indiced respectively by 1 and 2) are ϕ_{CV} (convective flux), ϕ_{SW} (short wave flux) and ϕ_{LW} (long wave). The outputs of the model are temperatures inside the wall, $\{Ti\}$, and surface temperatures T_{s1} and T_{s2} .

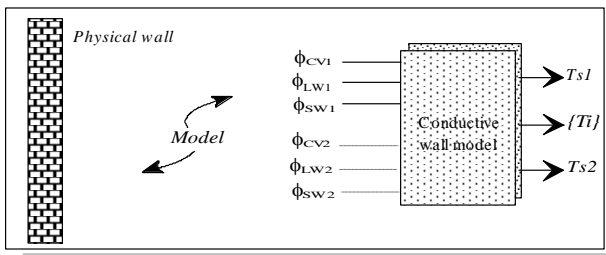

Fig. 2 : Conduction model for a wall

Concerning convection heat transfer, we choose a simple model considering surfaces and air temperatures (respectively T_s and T_a), illustrated by figure 3.

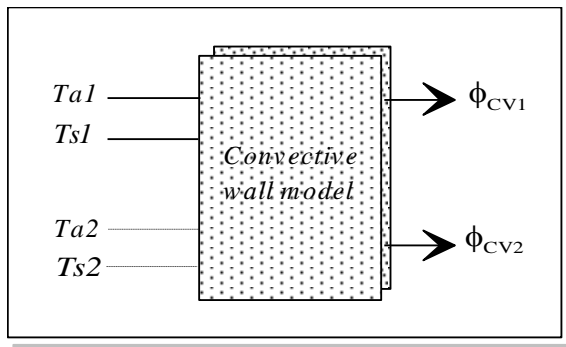

Fig. 3 : Convection model for a wall

For long wave exchanges, the chosen model computes long wave fluxes, ϕ_{LW} , on indoor and outdoor surfaces. One meteorological input is the sky temperature, T_c (another choice could be the outdoor radiant temperature). This model also needs the indoor surface temperatures, $\{T_s\}$.

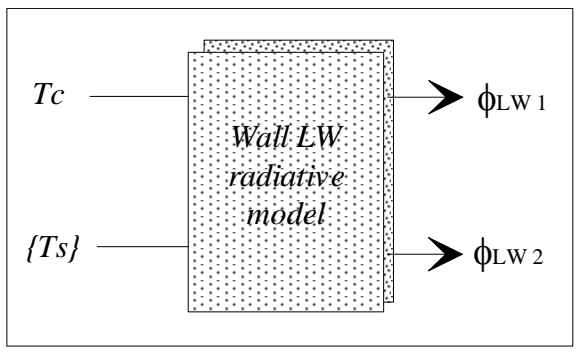

Fig. 4 : Long wave exchanges

Then, we consider on fig. 5 the simple following building, constituted by 3 walls (A, B and C) and a window.

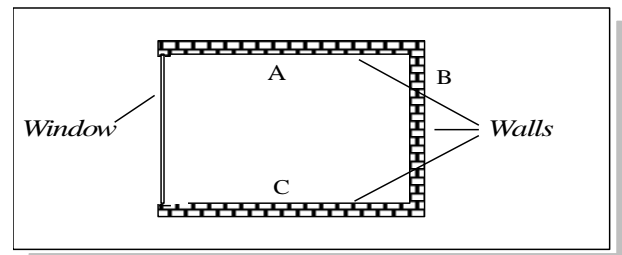

Fig. 5 : Simple building vue

Doing the same as for walls, it is possible to build thermal model for windows and air volumes (Boyer 93b). By assembling each model (conduction, convection, ...) of each component (walls, window, air volume), the analytic methods lead to the construction of a thermal model for the whole building (fig. 6). It's obvious to predict some problems in case of real buildings, composed of many walls, windows and rooms (assumed to thermal zones). The natural description for this method needs to inform all the connections between the different models.

This analytic method is in fact really close to physics laws. The main consequence is that simulation tools issued of the analytic modelisation method do not suit to professional users; TRNSYS (TRNSYS 79) could be one of these. In addition, this anatomic splitting up is not giving the designer much information about the way to describe the building, in terms of data structures

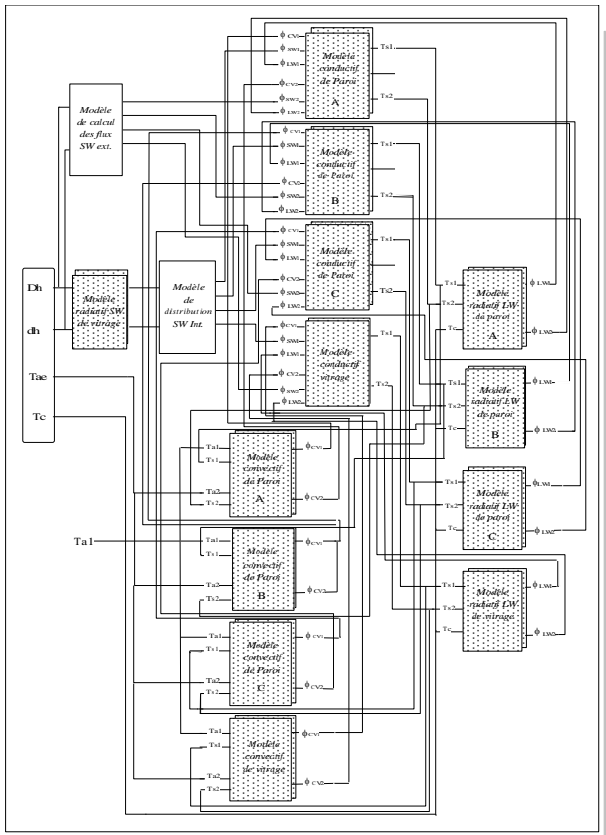

Fig 6 : Global model of previous building

In addition, this anatomic splitting up is not giving the designer much information about the way to describe the building, in terms of data structures.

2) Systemic analysis :

We'll show that this method allows us to council detailed modelisation and design orientation of our work. Bertalanffy (*Bertalanffy 68*) associates the systemic method to the question "What does it make ?", in opposition to analytic method, dealing with "What is this made of ?". The general system theory considers a system as an evolving black box, displayed on fig. 7, in interaction with environments (physical, legacy, ...), having aims and realizing functions.

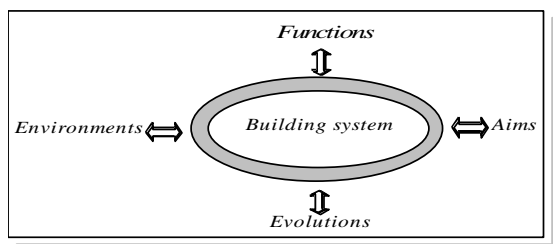

Fig. 7 : The General System

Robin (*Robin 91*) gives this definition of a building : A physical envelop, space close and covered, protecting of all outdoors actions an internal space. In regard to building thermal behaviour, considering its partitioning into rooms (for social, structural or economic reasons), the aim is to control the indoor climate of the whole building or of some of it parts. So, the aim of thermal design is showing the emergence of an entity, the thermal zone. It means one or few rooms, having similar thermal behaviour (including same HVAC conditions). A thermal zone is constituted of components, such as air volumes, HVAC systems, walls in contact with air volumes, In regard to this new object, next figure illustrates our first tree-like structure for a 3 zones building:

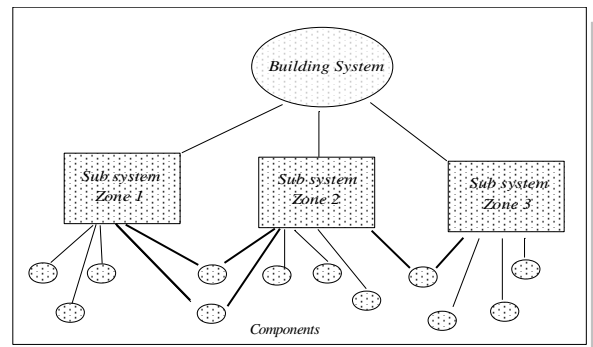

Fig. 8 : Systems hierarchy

Relations between the three levels of description (i.e. lines on the previous figure) exprimate belonging relations. So, if one room is considered as a thermal zone, we can say that the room belongs to the building. If this room is air conditioned, the HVAC system belongs to the zone. As given our definition of a thermal zone, a component may belong to two zones (bolded lines). Such a component (separation wall or opening) is performing the thermal coupling of the separated zones. To make the description easier, we prefer to introduce another object, the *Inter-zone*, to which the coupling components belong.

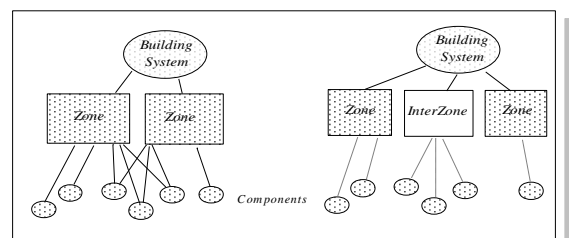

Fig. 9 : Systemic and conceptual building description

With the usual physical assumptions, we use the technique of nodal discretisation of the space variable by finite difference. In addition, the mass of air inside one

zone is represented by a single thermal capacity. Thus, for a given zone, the principle of energy conservation applied to each concerned wall node, associated with the sensible balance of the air volume, constitutes a set of equations, that can be condensed in a matricial form :

$$[C] \left\{ \frac{dT}{dt} \right\} = [A] \{T\} + \{B\}$$

In the previous equation, {T} is the vector of all the nodes of the zone and [C] is a diagonal matrix concerning their thermal capacities. [A] contains all the terms corresponding to energy exchanges in the considered zone and B represents solicitations. Considering the thermal coupling of sub-system zones (each having a matricial model), we solve each zone separately, assuming temperatures convergence. The figure 10 shows the way of coupling two zones (1 and 2), their intersection constituting the Inter-zone.

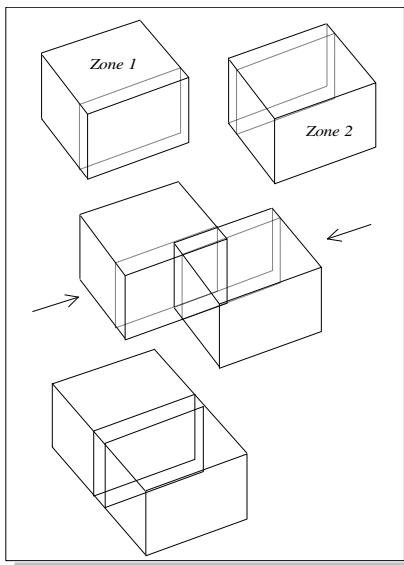

Fig. 10 : Thermal coupling of two zones

3) Data description for CODYRUN :

The three main parts of *CODYRUN* are the building description, the simulation program and the operation of the results. As far as the description is concerned, we have been brought to break down the building into three types of entities which are the following ones : firstly, the *Zones* (from a thermal point of view), the *Inter-zones* partitions (zones separations, outdoor being considered as a particular zone) and finally, the *Components* (i.e. walls, glass partitions, air conditioning system sets, ...). The following tree-like structure illustrates our organisation :

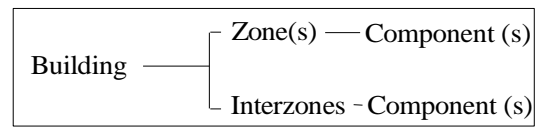

Fig. 11 : Data organization

Concerning our memory implementation, intensive use of dynamic allocation is made. The reason is that the number of zones, interzones and components is much variable, depending of course on the studied building, but also on the objectives of the simulation or on the thermal experience of the user.

The user's interface proposes to begin the description of a building with the following window :

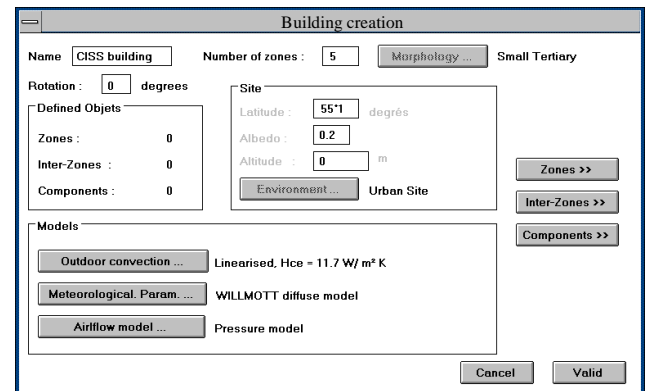

Fig. 12 : Building description window

A few information fields are associated to the building, as name and morphology, to its location (latitude, environment, ...). The border titled *Defined objets* remembers the number of zones, interzones and components previously attached to the building. The number of zones, informed during building creation, is a data that won't be modifiable. The choice we made was to condition the building description by the number of zones. The push buttons zone, interzone and components make possible the access to this previously defined entities. The access to the models linked to the entity "building" is also possible from this window through the push buttons of the screen part called "models". It is possible in this way to select the chosen models for outside heat convection transfer, reconstitution of meteorological parameters (diffuse and sky temperature) as well as the airflow model.

The second presented window is concerning the thermal zone entity. The main associated datas are a name (that will be needed later to affect components to this zone or for interzone location) and the volume. The push buttons < and > allow access to the window concerning respectively the previous and next zone.

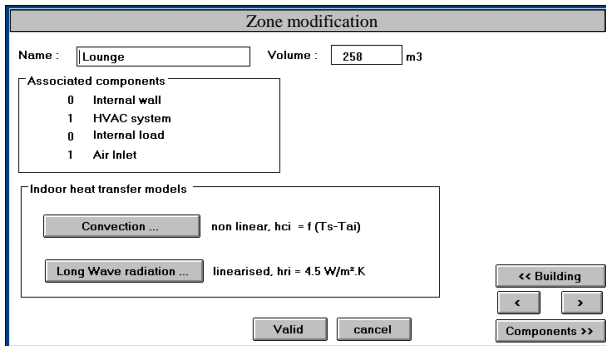

Fig. 13 : Zone description window

After filling building and zones windows, it's necessary to give informations about interzones. The name will be used to affect components. Each Interzone has a type, listed in the border tilted *Type*. This information is needed by models (for an opening affected to an interzone, the airflow model needs to know if the interzone is vertical or horizontal) or in order to control components affectation (for ex., no wall on slab in a vertical indoor interzone).

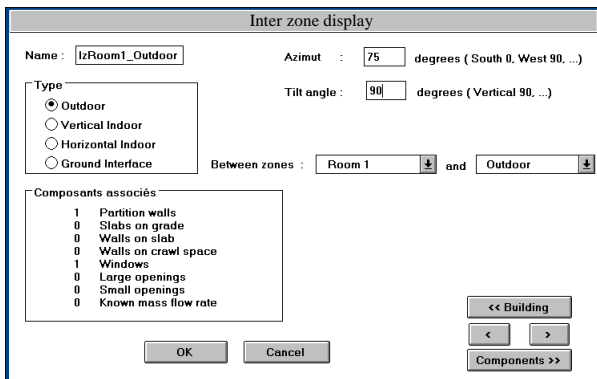

Fig. 14 : Interzone description window

The description now corresponds to a building squeleton. To complete, the following board lists the components already integrated :

Zone components	Interzone components
<i>internal wall</i>	<i>partition wall</i>
<i>HVAC system</i>	<i>slab on grade</i>
<i>Internal load</i>	<i>wall on slab</i>
<i>air inlet</i>	<i>wall on crawl space</i>
	<i>window</i>
	<i>large opening</i>
	<i>Small opening</i>
	<i>known air flow rate</i>

For all the components, the name, the type (among the proposed component types), and the name of the entity (zone or interzone) it belongs to. The following figure 15 is corresponding to an HVAC system, attached to a zone (by using the list box containing the names of the zones).

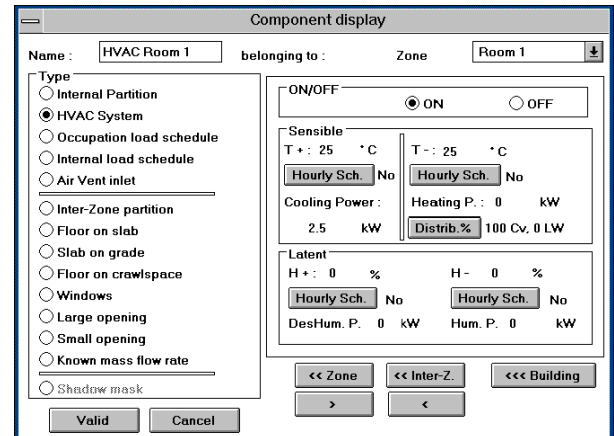

Fig. 15 : HVAC system description window

The components being of different types, specific information is needed for each component. Thus, for an air conditioning system, information relative to the sensible and latent loads are to be entered. We must then define the threshold temperature values (high and low), the hourly schedules and the available heating and cooling powers. Most of the time, simulation softwares consider the heating power as convective. However, to allow a better integration of systems such as heating floors, it is possible to choose for the involved power convective and radiative ratios.

Another example of component window is concerning a partition wall.

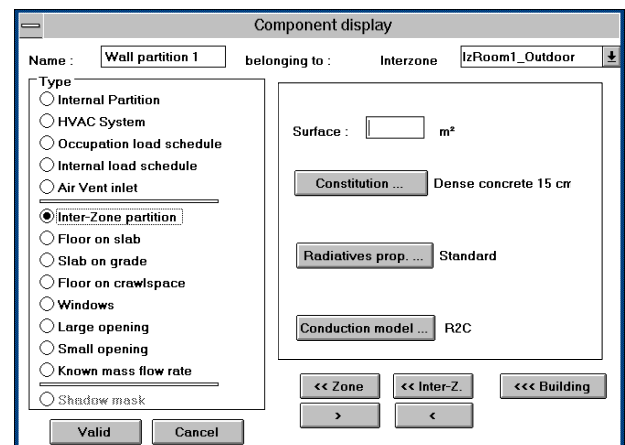

Fig. 16 : Wall description window

For such a component attached to an interzone, surface has to be entered, as constitution, radiative

properties and conduction model. For these three last groups of information, default values are assumed (and mentioned). Action on the corresponding push-button give access to other windows allowing to change these default values.

Conclusion :

Establishing the level of approach of the building professionals, the first part applies the systemic analysis to the thermal design of buildings. The consequence of the splitting up of the building makes evident the sub-system thermal zone and lays the foundations of our description of a building. The data structures linked to the building turn on to be complex due to the diversity of the situations that can be described (the number of zones, the constitution of the covering of the building, the integration of systems, ...). Our focusing on the modelisation method and building description led us to introduce some description windows of our multizone software, *CODYRUN*. Many aspects developed to this day in this software have been purposely put aside, in particular in regard to as the multiple model innovator feature (*Boyer 93a*) or airflow simulation. Meanwhile, for these points too, our work (*Boyer 93b*) shows the importance of systemic analysis.

TRNSYS, 1979. *User's guide*. Madison (U.S.A.) : Solar Energy Laboratory, University of Wisconsin, 1650 p.

References

Bertalanffy, L, 1968. *General system theory, foundation, development, applications*. G. Braziller, New York.

Boyer, H., Brau, J., Gatina, J.C. 1993. Multiple model software for airflow and thermal building simulation. A case study under tropical humid climate, in Réunion Island. *In Proceedings of Building Simulation '93*, (IBPSA, Adelaide, Aug.), 111-117.

Boyer, H., 1993. Conception thermo-aéraulique de bâtiments multizones. Proposition d'un outil à choix multiple des modèles. *Phd Thesis*, Institut National des Sciences Appliquées de Lyon, France.

Le Moigne, J.L., 1990. *La modélisation des systèmes complexes*. Dunod, Paris, Collection Afcet Systèmes.

Robin, C, 1991. Intégration de savoir expert et d'outils de simulation pour la conception thermique des bâtiments et des systèmes. *Phd Thesis*, Institut National des Sciences Appliquées de Lyon, France