



HAL
open science

Thermal performance of photovoltaic systems integrated in buildings

Dimitri Bigot, Frédéric Miranville, Idriss Ingar, Ali Hamada Fakra, Stéphane Guichard, Harry Boyer

► **To cite this version:**

Dimitri Bigot, Frédéric Miranville, Idriss Ingar, Ali Hamada Fakra, Stéphane Guichard, et al.. Thermal performance of photovoltaic systems integrated in buildings. Intech. Solar Collectors and Panels, Theory and Applications, Reccab Manyala (Ed.), InTech, pp.405-411, 2010, 978-953-307-142-8. 10.5772/10347 . hal-00767716

HAL Id: hal-00767716

<https://hal.science/hal-00767716>

Submitted on 20 Dec 2012

HAL is a multi-disciplinary open access archive for the deposit and dissemination of scientific research documents, whether they are published or not. The documents may come from teaching and research institutions in France or abroad, or from public or private research centers.

L'archive ouverte pluridisciplinaire **HAL**, est destinée au dépôt et à la diffusion de documents scientifiques de niveau recherche, publiés ou non, émanant des établissements d'enseignement et de recherche français ou étrangers, des laboratoires publics ou privés.

Chapter Number

Thermal performance of photovoltaic systems integrated in buildings

D. Bigot, F. Miranville, F. Ali Hamada, I. Ingar, S. Guichard & H. Boyer
*University of Reunion
France*

1. Introduction

1.1 History of photovoltaic systems ...

Photovoltaics is one of the leading chains of "sustainable development". Indeed, when one observes the development programs of energy systems in the countries or nations that move towards sustainable development, we find that the solar (and through it the production of energy through photovoltaics) represents the main axis of development.

One might at first believe that knowledge of the photovoltaic effect is recent. In fact, we must go back to 1839 with the French physicist Edmund Becquerel who first discovered the photovoltaic effect. It was during the period between the second half of the 19th and the Second World War (1945) that scientific knowledge related to solar phenomena were mastered. Thus, in 1875, Werner von Siemens presented to the Academy of Sciences in Berlin an article on the photovoltaic effect in semiconductors and it was Albert Einstein who first was able to explain the photovoltaic principle, thereby won the Nobel Prize for Physics in 1923.

After the Second World War, when the world gets in another war called "cold war" between the East Block in the West Block, the simmering conflict reached its apogee in the arms race and especially in the space conquest. The space industry is now rapidly finding new and innovative solutions that would power satellites into space. This was a boon for the photovoltaic sector and will help structure an industry.

Thus, in 1954, with the developed of a high efficiency photovoltaic cell for the time (6%) and in 1958, the rise of the yield to 9% and above, VANGUARD, the first satellite equipped with photovoltaic cells was sent to the space.

The oil shocks of the 1970s allowed the industry to begin its development in civilian applications in 1973 with the construction of the first house powered by solar cells at the University of Delaware. The next step was the construction of the first car equipped with a photovoltaic energy, which in 1983 covered a distance of 4000 km in Australia.

Yet in 1980, while the industry is launched commercially, the following years have seen its development focus mainly on rural electrification as well as some isolated houses for professional use (refuges, measuring stations, etc.) and for many villages in developed countries.

Since 1990, awareness of the phenomenon of global warming induced the development of the concept of sustainable development, with effect of boosting the photovoltaic and allows it to pass a critical level.

With the advent of power electronics, the use of PV systems connected to the network exploded in 2007, to represent over 90% of PV capacity installed. Then programs of grid-connected photovoltaic roofs appeared in 1995 in Japan and Germany, with a generalization from 2001.

1.2 ... Integrated in buildings

Integrating the frame represents the substitution of traditional building elements of homes and buildings with PV systems. This type of system offers the advantage of improving the profitability of a construction project from the substitution by the photovoltaic modules of traditional materials or equipment.

This may seem surprising at first, because of the cost of a photovoltaic system, but in fact, given the fact that the cost of redeeming a photovoltaic system integrated into the frame is low, the overall calculation of a construction project it is in fact improved.

The types of integration are built:

- Sloped roofs
 - Photovoltaic tiles
 - Systems integration of conventional modules
 - PV steel bins
 - PV membranes (in some cases)
- Flat roofs
 - PV membranes
 - Photovoltaic steel trays (in some cases)
- Facades
 - Conventional modules mounted on a metal specific structure
 - Systems integration of conventional modules (for some systems)
- Sun visors
 - Conventional modules mounted on a specific metal structure
- Windows
 - Semi transparent modules, translucent or only on specific structure

In France, the systems integrated into buildings can receive a higher purchase price with the "premium built integration". This bonus is awarded when the systems met the eligibility criteria.

The base rates and the premium rates are adjusted each year so that by 2009, rates for purchases are as follows:

Metropolitan France	Corsica & DOM TOM
Basic rate: 0.32823 € / kWh Grant for integration: € 0.27353 / kWh Integrated tariff: € 0.60176 / kWh	Basic price: € 0.43764 / kWh Grant for integration: € 0.16412 / kWh Integrated tariff: € 0.60176 / kWh

Table 1. Rates of photovoltaic energy in France in 2009

The solar integrated building is a French particularity.

The architectural integration of photovoltaics promotes a healthier growth of the sector, because avoids speculative effects related to the explosion of large solar parks.

Since July 2006, France has thus feed-in tariffs of PV highest in the world with a significant premium to the frame integration, thereby stimulating the market to maturity.

Financial incentive in addition to the context of fiscal incentive (tax credit, VAT at 5.5%, aid communities) and regulatory objectives are clear and ambitious (23% renewable by 2020, nine buildings positive energy around 2020).

Investment in building integrated photovoltaics is now a 20-year guaranteed investment, which generates an average return rate of 8 to 10%.

1.3 From global warming ...

Global Warming is one of the most controversial sciences from the 21 st century, challenging the very structure of our global society. The problem is that global warming is not just a scientific concern, but encompasses economics, sociology, geopolitics, local politics, and individuals' choice of lifestyle. Global warming is caused by the massive increase of greenhouse gases, such as carbon dioxide, in the atmosphere, resulting from the burning of fossils fuels and deforestation. There is clear evidence that we have already elevated concentrations of atmospheric carbon dioxide to their highest level for the last half million years and maybe even longer. Scientists believe that is causing the Earth to warm faster than at any other time during, at the very least, the past one thousand years. The most recent report by the Intergovernmental Panel on Climate Change (IPCC) states that there is a clear evidence for 0.6°C rise in global temperature and 20 cm in sea level during the 20 th century.

The IPCC also predicts that the global temperatures could rise by between 1.4°C and 5.8°C and sea level could rise by between 20 cm and 88 cm by the year 2100.

1.4 ... to energetic optimization of buildings

The electrical energy consumed in a building is divided on such items as lighting, equipment (Hi-Fi, TV ,...) production of hot water, electric heating, air conditioning ... but the position still remains the majority consumer of heating or cooling (depending on whether it is summer or winter). However, the introduction of PV plant on the roofs of buildings can impact the use of air conditioning because the plant acts as a double skin on the roof. Thus, there is a direct relationship between the presence of a PV installation on a building with its power consumption because of the role played by the central insulation in reducing the operating time of air conditioning, so the power consumption of the building. The challenge is thus to be able to model the coupling PV production - profile of energy consumption in a building to control the operation of energy consuming equipment that they operated during hours of plant output PV. This is the approach that, combined with a master's program of energy in the building, ultimately achieves what is called a positive energy building, meaning a building that produces, much less energy than it consumes.

2. Methodology

2.1 Context and objectives

The purpose of this study is to establish a physical model able to describe, transiently, the thermal phenomena taking place in a Building Integrated Photovoltaic systems (BIPV) or Building Added Photovoltaic system namely BAPV (see Fig 1). The model should be able to take into account the different positions of photovoltaic panels (inclined, horizontal and vertical) that are integrated into the architecture of the building (roof, facades, awnings, closeroofs, etc.).

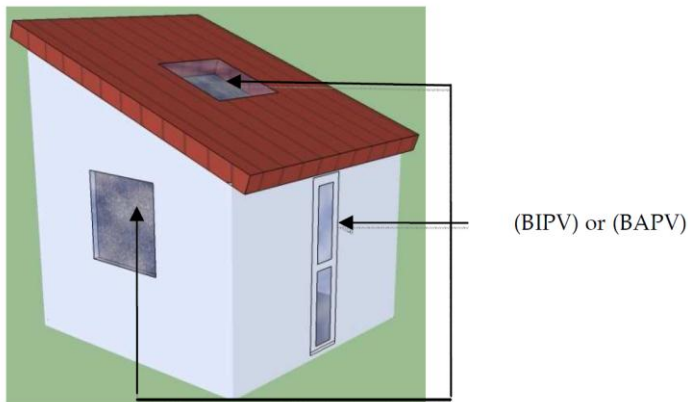

Fig 1. Illustration of BIPV and BAPV

Moreover, it is important for the results to be validated, in order to allow their use when dealing with studies about renewable energy and building energy consumption and optimisation. For this, worldwide recognized procedures exist and can be applied to implemented models to test their general behaviour under given conditions.

2.2 Literature review

In the early 1990s, BIPV started to become more important. Many studies have been conducted to describe the evolution of the temperature of BIPV products and systems. These studies were conducted in different fields of scientific research:

- The development of physical models;
- The design of experimental devices;
- Finally, the conception of software's capable to give the evolution of this temperature in the space and the time. Other research has been conducted to ensure the reliability of the software to simulate correctly the temperature.

This paragraph presents an inventory of all the work developed in the field of BIPV.

2.2.1 Existing models

In 2001, Zondag did a numerical study on the BIPV roof (Zondag, 2001). Kropf (Kropf, 2003) developed a simulation model for dynamical calculation of the heat gain of BIPVT. Many models have been conducted as for BIPV-Thermal system included facade- integrated and roof-integrated PVT (Photovoltaic and Thermal collector), system ventilation BIPV (Zondag, 2008); (Bazilian & Prasad, 2001); (Bazilian, 2002.) ;(Kondratenko, 2003.). Generally, there are three models types for characterize dynamic and steady state aspects: experimental, numerical (3D, 2D and 1D), and analytical models of performance of BIPV systems.

In 2006, Wang (Wang et al, 2006) compared four thermal models, one-dimensional, transient, for different roofs to evaluate the impacts of BIPV on the building's heating-and-cooling loads: ventilated air-gap BIPV, non-ventilated (closed) air-gap BIPV, close roof mounted BIPV, and conventional roof with no PV and no air gap. An objective of this study was to evaluate the photovoltaic performances and building cooling-and-heating loads across the different roofs in order to select the appropriate roof BIPV system.

Jie (Jie et al, 2007) developed a two-dimensional thermal model of PV glass panel and model of the PV-Trombe wall system. These models can be used to predict the temperature distribution of a room at any time too.

Guiavarch and peuportier (Guiavarch & Peuportier, 2006) calculated the thermal yield of a BIPVT (Building Integrated Photovoltaic and thermal collector system) for climate of Paris and Nice (in France).

Tian (Tian et al., 2007) introduced a PTEBU model. This model described the thermal influence of BIPV on microclimate of urban canopy layer.

In 2008, Fung (Fung & Yang, 2008) presented the Semi-transparent Photovoltaic module Heat Gain (SPVHG) model for evaluating the heat gain of semi-transparent photovoltaic modules of BIPV applications on one-dimensional transient heat transfer.

In the same year, Chow (Chow et al., 2007) have taken over the work of Jiménez and presented a numerical modelling (based on the multi-node scheme) of a building integrated photovoltaic and water-heating (BIPVW) system. The authors have gathered the various existing models in the field of thermal building, photovoltaic and thermal collector system in a single dynamic model of the BIPVW system.

In 2008, Jiménez (Jiménez et al., 2008) worked on the linear and non linear continuous time modelling of physical systems using discrete time data (stochastic models), in particularly,

on BIPV systems. Continuous-discrete stochastic state space model consists of a set of Stochastic Differential Equations (SDE's) describing the dynamics of the system in continuous time and a set of discrete time measurement equations.

In 2009, Skoplaki (Skoplaki, & Palyvos, 2009) established the important role of the operating temperature in relation to electrical efficiency of a BIPV array. Authors developed an implicit correlation for the PV operating temperature and compared the empirical modelling with other implicit and explicit equations for T_c (cell/module operating Temperature) in the scientific literature review. The author recommends being careful in applying a particular expression to BIPV installation because the available equations have been developed with a specific mounted geometry or building integration level in mind.

In 2009, Nynne (Nynne et al., 2009) presented a new mathematical modelling of the heat transfer of BIPV modules for a stochastic non-linear physical system. This model takes into account ambient wind velocity and the PV module temperature variations.

In 2010, Steven and Benjamin (Steven & Benjamin, 2010) developed a Finite Element Model (F.E.M) applied into a double pane glazing system. The model is capable to study the thermal and electrical performance for an opaque Active Thermal Insulator (A.T.I) glazing system. A.T.I- systems represent a new thermal control technology that uses solar energy to compensate for passive heat losses or gains in building envelopes.

2.2.2 Experiment tests cases and validations

Many Scientific studies were conducted, in the world, on BIPV and BAPV systems. Most significant and recent studies that were treated in the thermal aspect of BIPV systems are as follows.

In 2001, Cherruault (Cherruault & Wheldon, 2001) evaluated the performance of BIPV system installed in the refurbishment of the roof at the University of Reading in UK. The report contained many references of thermal measurement database of the BIPV.

In 2008, Xu (Xu & Dessel, 2008) worked on the technology of Active Building Envelope (ABE) in particularly, the experimental ABE window-system for the testing room in USA. Test set up and protocol of measuring errors of BIPV was described.

Trinuruk developed other experimental test cases in 2009 (Trinuruk et al., 2009). Indeed, Authors developed Scale Models that represented structure envelopes of building in Thailand and integrated BIPV systems (Photovoltaic in the façade of the wall). Experimental facility and measuring equipment set up was presented in this work. The PV module installed can be positioned with different inclination angles relative to the test room (Scale Model).

Bigot has worked on Isotest cells (scale models tests rooms) and compared the experimental thermal performance of BIPV in tropical region. Results of experimental measurements have shown that building added photovoltaic systems might reduce the temperature inside the building around 3-6 degrees depending on the configurations chosen (Bigot et al. 2009).

In 2009, Mei (Mei et al., 2009) presented the results of a laboratory based experimental investigation undertaken to determine the potential for high temperature operation in such a BIPV installation in UK.

In this same year, Park (Park et al., 2010) studied the thermal performance of a semi-transparent PV module that was designed as a glazing component. The experiment was performed under both Standard Test Condition (STC) and outdoor conditions.

2.3 A combined approach (M.E.V.)

To determine both the thermal behaviour and the performances of BIPV and BAPV installed according to the state of the art, it is important to combine three parts: Modelling, Experimentation and Validation (what we'll indicate as M.E.V.). The first one consists of the detailed modelling of the energetic system composed of the whole building, including the added PV panels. For this, it is necessary to define the correct level of description in order to be able to use the results during practical studies. This part is illustrated on the left side of fig 2.

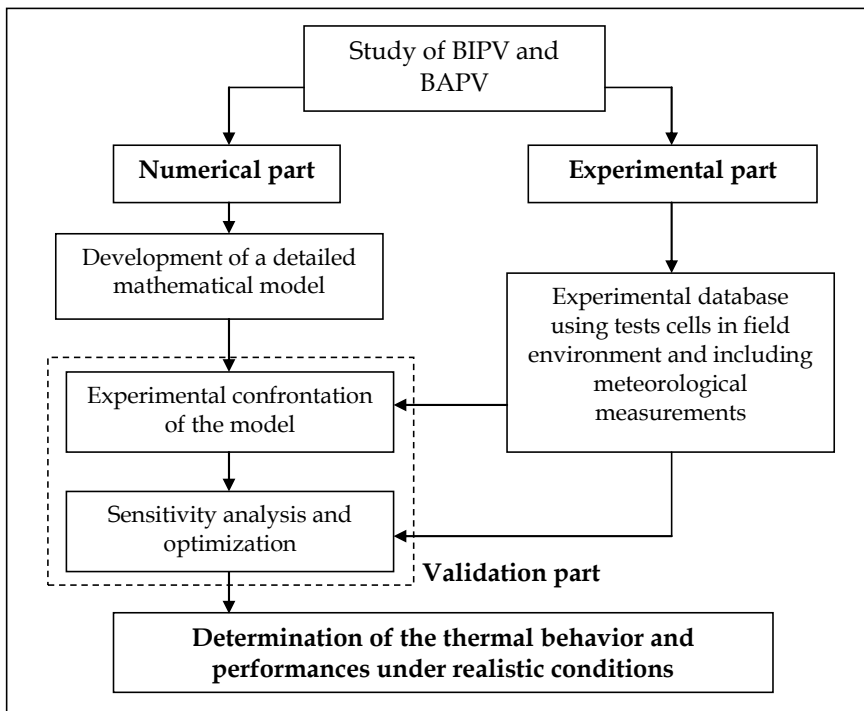

Fig 2. General overview of the methodology

The detailed model then goes through a validation step, including comparisons with measurements and also two important analyses: parameters sensitivity and optimization. At the end of the process, the model can be used to determine, in several conditions, the general thermal behaviour of the building as well as its performances.

The corresponding steps indicated on the right side of fig 2., concern the experimental part. Indeed, to be able to run the validation process, it is necessary to have at least one measurement database, for comparisons. Such data have to be of high quality and correspond to realistic conditions. It also has to be constituted such that direct comparisons of equivalent variables in both the model and the experimentation can be done. Parameters

as time step of measurements, location of the sensors, errors calculations of the whole data acquisition system have to be determined to ensure the accuracy of the results.

The last part combine the two preceding ones, in the sense that it uses the predictions of the model, and also the measurements included in the database. The validation step follows a worldwide known procedure, known as the BESTEST procedure (Judkoff et al., 1995). It consists of verifying the calculation code of the model, through analytical tests and inter-software comparisons, and also of validating the model, through predictions/measurements comparisons and also a detailed analysis of the model, with sensitivity analysis, optimisation and corroboration.

2.4 Numerical and experimental tools

To apply the above methodology, numerical and experimental tools are needed. In our case, they have been totally developed and dedicated to the present study and constitute an original contribution to international studies about complex wall, especially including PV systems. Many publications have involved these tools, for example (Miranville, 2003) and (Bigot, 2009).

The numerical code used to predict the thermal response of the whole building envelope is part of the thermo-hygro-aeraulic simulation codes and is based on a multizone description of the physical system (here composed of the building and its very specific wall with PV). Specific developments have been done to allow the correct modelling of the system, with a very special focus on radiative exchanges in semi-transparent layers. The corresponding model is described further and constitutes the main addition to the building simulation code that is necessary for predicting the temperature field.

In terms of experimental equipment, a dedicated platform has been set up, build in field environment, constituting a unique case for the French overseas departments. It is composed of several test cells, as it will be described further, allowing the collection of experimental databases, needed for comparisons with code predictions. Combining the two tools give a powerful means to analyse the adequacy between models and measurements and thus go further in the knowledge about building physics.

2.5 Performance indicators

Once a model is validated, it can be used to evaluate the thermal performance of the building; if the aim of the study is to calculate the thermal performance of a wall, several performance indicators can be used:

1. The R-value
2. The percentage of reduction of the heat flux

The R-value is the most known performance indicator for walls, as it is part of the theory of heat transfers, in particular for steady state conditions. In field environment, with measurements, it is possible to calculate the R-value, using dynamic values. The used method to reach this objective is called the average method and is well known among performance materials researchers. Restrictions for the obtaining of correct values are

imposed. If well used, it is possible to determine a R-value which is very near from the indicator in steady-state conditions.

The average method is precisely described in (ISO-9869, 1994) and is based on an evaluation of the thermal resistance R of a wall with the following mathematical expression:

$$R = \frac{\sum_{i=1}^n (T_{se,i} - T_{si,i})}{\sum_{i=1}^n \varphi_i} \quad [m^2.K / W]$$

With:

$T_{se,i}$: outer surface temperature of the wall [K]

$T_{si,i}$: inner surface temperature of the wall [K]

φ_i : heat flux density through the wall [W/m^2]

Another well-used indicator, when dealing with performance of complex walls, is the percentage of reduction of the heat flux. Its application requires comparative experimental or numerical studies, one set with the specific wall, another set equipped with a reference wall. The calculation is simply done according to the following equation:

$$\text{Percent reduction} = \frac{\int_{\text{evaluation period}} \varphi_{\text{wall with PV}} \cdot dt - \int_{\text{evaluation period}} \varphi_{\text{wall without PV}} \cdot dt}{\int_{\text{evaluation period}} \varphi_{\text{wall without PV}} \cdot dt}$$

These two indicators are often used to demonstrate the thermal performance of building walls, and are usually evaluated in the post-processing step of models results.

3. Modelling of building integrated PV (BIPV)

3.1 Physical and structural description

In this study, interest has focused on photovoltaic systems installed on buildings. Specifically, on systems that are installed on the walls of a building, either in front or on the roof. Such systems are generally integrated into the architecture of the building; they are designated by the term "BIPV" i.e. "Building Integrated Photovoltaics". These systems can be installed on the roof of a building, like sun protection in front, in walls or trombe walls, or embedded in glass windows.

In this context, and in order to approach the building simulation code that will be subsequently used, it was decided to consider these systems as a particular type of wall. The walls of a building are generally opaque except glasses of windows. So the photovoltaic wall system has been considered like an assembly of the photovoltaic panel and the wall that supports it.

The characteristic of a photovoltaic system, compared to other types of walls encountered in a building, is that a part of its component layers is semitransparent. Semitransparent layers are mainly those of the panel that produce electricity. They are an assembly of materials,

generally glass, and the silicon under it (or other semiconductor material that can produce electricity when exposed to radiation). In addition, silicon is typically encapsulated in two layers of material used to protect it (see Fig 3).

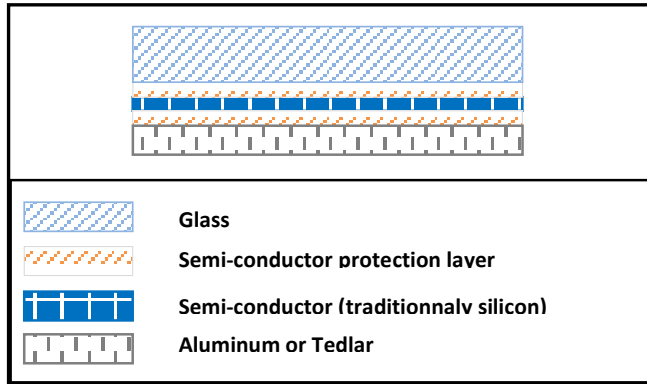

Fig 3. Cross section of a typical photovoltaic panel

In these semitransparent layers, complex radiative phenomena occur. Indeed, the multiplicity of layers causes complex reflection phenomena in the semitransparent medium. This is shown in Fig 4. A ray of light that reach the surface of a layer of material will be decomposed into three fluxes: absorbed, reflected and transmitted.

Furthermore, another feature of the system is that it may contain air or water gaps. These air gaps may be contained in the wall where the panel is installed or between the wall and the photovoltaic panel (as in the case of trombe walls or on some photovoltaic roof). The blades of water are present in hybrid PV systems. These layers of fluid are complex to model, and are host of phenomena due to different ventilation system integration in the building. They may be influenced by conditions outside the system (such as wind in the case of opened air gaps in roof installations).

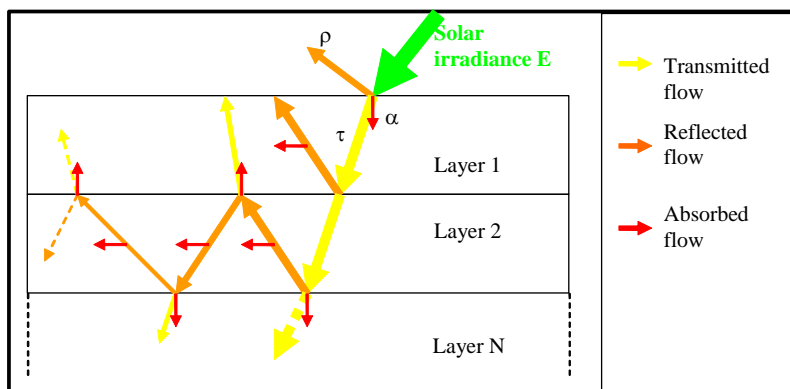

Fig 4. Section view of the multiple reflections phenomena in a semi-transparent multilayer material

3.2 Thermal phenomena and assumptions

The walls are modelled layer by layer. The goal is to find the energy transfer across the solar system and its coupling with the building, it is not necessary to model finely phenomena. In addition, the coupling of the wall model with the PV will be done with an existing code, named Isolab (Miranville, 2003). This code models each type of walls in the same manner, by reducing the thermal problem at the scale of the material layer.

Isolab is a building simulation code able to predict the heat and mass transfer in buildings according to a nodal 1D description of the building and its corresponding thermo-physical and geometrical parameters. The resolution is based on a finite difference numeric scheme and the system of differential equations, written in a matrix form, is solved numerically for each time step.

In the version of Isolab that was used as the basis for this work, the walls are described by using heat balance equation. This equation is discretized by finite difference method dynamically according to a nodal 1D description in the thickness of each wall.

The heat transfer equation takes into account the conduction phenomena in different layers. But the phenomena occurring in convective fluid layers and radiative semitransparent layers must be described specifically.

Regarding the fluid layers, the choice was made to use empirical models. These models can characterize the convective heat flux by determining the coefficient of convective heat exchange between the fluid and the considered wall. This coefficient will depend on the flow regime in the fluid layer, and the temperature of the fluid. Several models have been chosen to perform the tests; they were chosen to meet the most technical configurations of the panel (Bigot, 2009). Note that the models chosen are not necessarily the most appropriate in some cases. The goal here is to test the ability of these models to describe our system. It will be necessary in the future to choose other models as appropriate, and validate them. These models were implemented directly in the PV model code. They are chosen automatically by the program as needed (cavity vertical, inclined, horizontal, or depending on the configuration of the air layer in terms of opening to the outside, and thus ventilation).

To model the radiative phenomena in the semitransparent medium, the model chosen follows the "ray tracing" method. It is presented in the next section.

3.3 Derivation of the problem

The « ray tracing » method is a model that can describe radiative exchanges in semitransparent mediums. In this work, the model was inspired of Robert Siegel works (Siegel, 1992). This model consists on a net radiative balance of fluxes at each layer of material. As its name suggests, a ray of light will be followed and dispatched every time it will meet a new material surface (see Fig 4). With each new surface it encounters, the ray will be divided into three parts until meeting an opaque layer: the flux absorbed by the layer encountered, the flux transmitted through this layer, and the flux reflected by this layer to

the layer where the ray comes from. These phenomena are reproduced until encounter an opaque layer (the layer N where $\tau > 0$ on Fig. 4).

A system describing radiative flux exchanges can be defined for such a problem:

$\Phi_{\text{abs}}(i,1,j)$ is the flow absorbed by the layer i at the iteration j on its exterior face ($\Phi_{\text{abs}}(i,2,j)$ corresponds to the inside); $\Phi_{\text{trans}}(i \rightarrow k,j)$ is the flux transmitted on the layer k by the layer i in the iteration j , and $\Phi_{\text{ref}}(i \rightarrow k,j)$ is the reflected flux by the layer i on the layer k for the iteration j . In the below relations, the indicated physical parameters are the following:

Φ_i : absorption coefficient of the layer i
 Φ_i : transmission coefficient of the layer i
 Φ_i : reflectivity coefficient of the layer i
 Φ_i : emissivity coefficient of the layer i
 F_{pe} : view factor between the panel and the environment
 F_{pi} : view factor between layers i and j
 E : incident shortwave radiation
 T_i : temperature of the layer i
 Φ_{abs} : absorbed radiation flux
 Φ_{trans} : transmitted radiation flux
 Φ_{ref} : reflected radiation flux

In terms of equations, the physical phenomenon can be described as indicated below:

• Initial condition:

$$\Phi_{\text{abs}}(1,1,1) = E \cdot S \cdot \alpha_1 \cdot F_{\text{pe}}$$

$$\Phi_{\text{trans}}(1 \rightarrow 2,1) = E \cdot S \cdot \tau_1 \cdot F_{12}$$

$$\Phi_{\text{trans}}(N+1 \rightarrow N,1) = \varepsilon_{N+1} \cdot \sigma \cdot S \cdot T_{N+1}^4 \cdot F_{N+1,N}$$

• Boundary conditions: for $2 \leq j \leq I$:

$$\Phi_{\text{abs}}(1,2,j) = \Phi_{\text{abs}}(1,j-1,2) + (\Phi_{\text{ref}}(2 \rightarrow 1,j-1) + \Phi_{\text{trans}}(2 \rightarrow 1,j-1)) \cdot \alpha_1 \cdot F_{21}$$

$$\Phi_{\text{trans}}(N+1 \rightarrow N,j) = 0 ; \Phi_{\text{trans}}(1 \rightarrow 2,j) = 0 ; \Phi_{\text{ref}}(1 \rightarrow 2,j) = 0$$

$$\Phi_{\text{ref}}(N+1 \rightarrow N,j) = (\Phi_{\text{trans}}(N \rightarrow N+1,j-1) + \Phi_{\text{ref}}(N \rightarrow N+1,j-1)) \cdot \rho_{N+1} \cdot F_{N+1,N}$$

• System description: for $2 \leq j \leq I$ et $2 \leq i \leq N$:

$$\Phi_{\text{abs}}(i,1,j) = \Phi_{\text{abs}}(i,j-1,1) + (\Phi_{\text{ref}}(i-1 \rightarrow i,j-1) + \Phi_{\text{trans}}(i-1 \rightarrow i,j-1)) \cdot \alpha_i \cdot F_{i-1,i}$$

$$\Phi_{\text{abs}}(i,2,j) = \Phi_{\text{abs}}(i,j-1,2) + (\Phi_{\text{ref}}(i+1 \rightarrow i,j-1) + \Phi_{\text{trans}}(i+1 \rightarrow i,j-1)) \cdot \alpha_i \cdot F_{i+1,i}$$

$$\Phi_{\text{ref}}(i \rightarrow i-1,j) = (\Phi_{\text{trans}}(i-1 \rightarrow i,j-1)) \cdot \rho_i \cdot F_{i-1,i}$$

$$\Phi_{\text{ref}}(i \rightarrow i+1,j) = (\Phi_{\text{trans}}(i+1 \rightarrow i,j-1)) \cdot \rho_i \cdot F_{i+1,i}$$

$$\Phi_{\text{trans}}(i \rightarrow i-1,j) = (\Phi_{\text{trans}}(i+1 \rightarrow i,j-1) + \Phi_{\text{ref}}(i+1 \rightarrow i,j-1)) \cdot \tau_i \cdot F_{i,i-1}$$

$$\Phi_{\text{trans}}(i \rightarrow i+1,j) = (\Phi_{\text{trans}}(i-1 \rightarrow i,j-1) + \Phi_{\text{ref}}(i-1 \rightarrow i,j-1)) \cdot \tau_i \cdot F_{i,i+1}$$

The absorbed flux by the layer situated after the PV system and the absorbed flux by each layer are known:

$$\Phi_{abs}(N+1,1) = \alpha_{N+1} \cdot F_{N,N+1} \cdot \sum_{j=1}^{j=I} \Phi_{trans}(N \rightarrow N+1, j)$$

$$\Phi_{abs}(i,1) = \sum_{j=1}^{j=I} \Phi_{abs}(i, j, 1)$$

$$\Phi_{abs}(i,2) = \sum_{j=1}^{j=I} \Phi_{abs}(i, j, 2)$$

Iterations can be stopped when the residual energy of the system is lower than a threshold value (*erreur*):

$$\sum_{i=1}^{i=N} (\Phi_{trans}(i, j) + \Phi_{ref}(i, j)) - \sum_{i=1}^{i=N} (\Phi_{trans}(i, j-1) + \Phi_{ref}(i, j-1)) \leq erreur$$

The integration of the PV module to the building simulation is done according to the synoptic of Fig. 5. Once the thermal model of the considered building without PV panels is generated, a test is done in order to detect the inclusion of PV panels; if PV panels are detected, the PV module generates the corresponding system of equations and solves the whole model. Results can then be analysed.

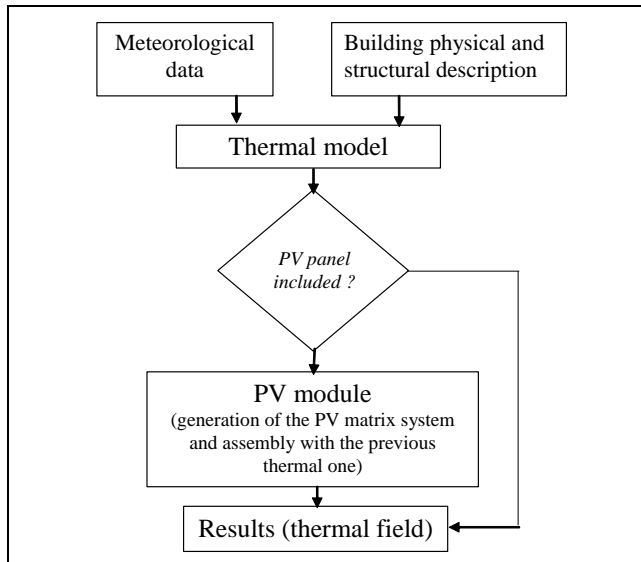

Fig 5. Integration of the PV calculation module to the existing Isolab code

3.4 Numerical resolution

By discretizing the heat equation below as described above, we obtain a system describing the evolution of the temperature in each building wall. This system of equations can be written in matrix form to facilitate its handling and resolution.

$$\frac{\partial^2 T}{\partial x^2} = \frac{1}{a} \cdot \frac{\partial T}{\partial t} - P \quad \text{where} \quad a = \frac{\lambda}{\rho \cdot C_p}$$

In the case where the material is a semi-transparent layer, P is the radiative energy absorbed by the semi-transparent layer. P is null in other cases.

We solve this equation by discretizing with a finite difference method. Each layer of material is cut in many nodes. We obtain three types of equations by doing the discretization:

- A first for nodes inside the layer:

$$T_c^t = -\frac{\Delta t}{\tau_c} \cdot T_{c+1}^{t+1} + \left(1 + 2 \cdot \frac{\Delta t}{\tau_c}\right) T_c^{t+1} - \frac{\Delta t}{\tau_c} \cdot T_{c-1}^{t+1} + P$$

- A second for nodes on extremity of the wall or near a fluid layer (c is the number of the node in the wall):

$$T_c^t = \left(1 + 2 \cdot \frac{\Delta t}{\tau_c}\right) \cdot T_c^{t+1} - \frac{2\Delta t}{\tau_c} \cdot T_{c-1}^{t+1} - \frac{2\Delta t}{C_c} \cdot \varphi_{inc}$$

- A third for nodes of the surface between two conductive materials:

$$T_c^t = \frac{k_{c+1}}{k_c + k_{c+1}} \cdot T_{c+1}^t + \frac{k_{c-1}}{k_c + k_{c-1}} \cdot T_{c-1}^{t+1}$$

$$\text{Where: } \tau_c = \frac{C_c}{k_c} ; \quad C_c = \rho_c \cdot C_{pc} \cdot \Delta x ; \quad k_c = \frac{\lambda_c}{\Delta x}$$

For surface node temperatures, the φ_{inc} corresponds to the sum of convective and radiative exchange fluxes.

These equations are applied to all nodes of the building system, and we obtain an equation system that describes the evolution of each temperature. It can be expressed in a numeric form by the following matrix equation:

$$[A]_i \cdot [T]^t = [A]_e \cdot [T]^{t+1} + B$$

Matrixes $[A]_i$ and $[A]_e$ describe the composition of the various materials constituting the building, while $[B]$ corresponds to outside or internal solicitations of the system. Matrixes $[T]^t$ and $[T]^{t+1}$ contain all nodes temperatures of all walls.

Finally, a matrix system is obtained that describes the temperature evolution of the PV wall. It is included like a traditional wall by Isolab to the matrix building system. Function of the surfaces, the PV wall is partly or totally substituted to the wall where the PV panel is installed.

4. Experimentation of BIPV

4.1 A dedicated experimental platform

In order to apply the preceding combined methodology, a dedicated experimental platform was set up, in field environment. It is indeed very important to be able to determine the physical behaviour of the whole building equipped with the BIPV or the BAPV, under realistic conditions. For this, the experimental platform includes several cells, facing north, and fully instrumented. A meteorological station is also integrated, to allow the measurement of the climatic conditions of the location. The cells are of two types. A large scale test cell, named LGI, is used to represent typical conditions of a real building and its thermal response. Four other cells (ISOTEST cells) are installed on the platform, reduced size and dedicated to the simultaneous comparison of different types of walls installed on buildings. An overview of the platform is presented on fig 6 and the two types of cells are illustrated on fig 7.



Fig 6 & 7. The experimental platform and the test cells

The study undertaken here is made with ISOTEST test cells in order to compare directly the cases between the buildings which are equipped with a PV panel and those which are not (see fig 8 and 9). These experimental cells have indeed been set up to allow a comparison between the several types of roof components, all in the same conditions. Each of them is equipped with a specific roof component and is fully instrumented to allow the physical observation of the energetic behaviour. It has an interior volume of about 1m^3 and is conceived from a modular structure, which means that with the same cell we can study different configurations and phenomena. This is why the walls are movable. It constitutes a basis for the thermal studies of building components, with the advantage of flexibility and easy-to-use, especially when several products must be tested. It is installed in-situ, which allows us a better observation of the actual behaviour of the cell. Thanks to this method, we are able to know the temperature of each part of the system in different configurations but in the same environmental conditions. Comparisons between the test cells have been made. Before this, a calibration step has been done to make sure that the four cells had the same thermal behaviour.

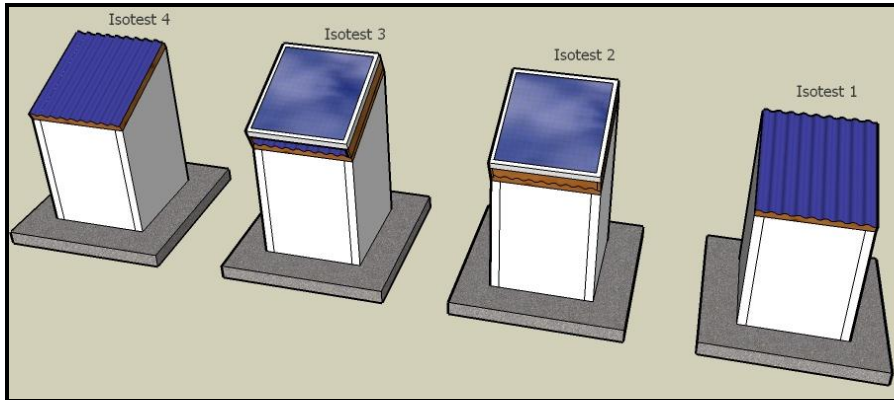

Fig 8. Current aerial view of Isotest Cells



Fig 9. Photography of Isotest cell without and with PV panel

4.2 Data acquisition sensors and errors

The data measured in this experiment are inside surface temperatures of walls and roof, air temperatures, and heat flux through each roofs (see fig 10). The global error of these measurement equipments (sensors and data acquisition system) is about one degree celsius ($\pm 1^{\circ}\text{C}$) for the temperature and $\pm 10\%$ for the heat flux (Miranville, 2002). The last study made with this equipment dating for one year, it was necessary to calibrate the equipment. This was done by running a calibration procedure consisting in determining the calibration coefficient allowing the correct inter-comparison of the response of the cells.

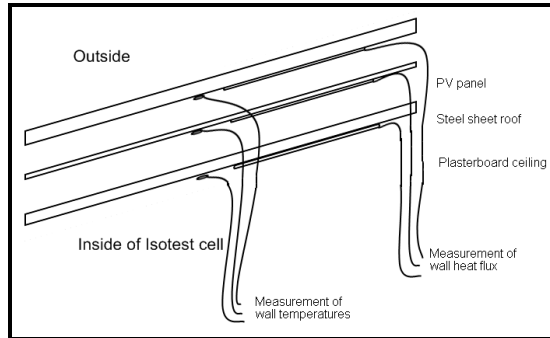

Fig 10. Sensors installation in the roof wall.

5. Validation

5.1 Overview

Building simulation codes are useful to point out the energetic behaviour of a building as a function of given inputs. The steps involved in this process depend on a mathematical model, which is considered a global model because it involves several so-called elementary models (conductive, convective, radiative, etc.). Therefore the validation procedure will involve verifying not only the elementary models, but also their coupling, as the building model can be seen as the coupling of a given combination of elementary models.

For several years a common international validation methodology has been developed, which, among others, has led to Anglo-French cooperation. This latter brought to fruition a common validation methodology, involving two test categories, as indicated in table 2.

Verification of the basic theory Verification of good numerical behaviour Comparison of software Analytic verification of elementary models	'Pre-Tests'
Parametric sensitivity analysis Empirical validation	'Post-Tests'

Table 2. Global validation methodology

The first, generally called 'a priori' or 'pre-' tests, involves the verification of the programming code, from the under-lying theory of the elementary models, to software comparisons, and finally to analytic verifications. The objective is to ensure the correct implementation of the elementary models and the correct representation of their coupling at the level of the global model.

This important step of validation justifies the development of dedicated software tools, such as the BESTEST procedure (Judkoff et al., 1995). This latter is essentially based on the comparison between the programming code predictions with so-called reference software results, for a range of different configurations. As a result it includes aspects of verification of correct numerical behaviour and of cross-software comparison, and allows us to compare the program to analogue tools. If the results compare well with those found during this procedure, the programming code is considered acceptable.

The second part of the validation methodology, known as the ‘a posteriori’ or ‘post-’tests, involves two main steps, the parametric sensitivity analysis and, most important, the empirical validation. This second step is fundamental, because it compares the program’s predictions with the physical reality of the phenomena, using measurements. It therefore requires an experiment to be set-up, with the aim of obtaining high quality measurements.

The sensitivity analysis of the model consists of finding the set of parameters with most influence on a particular output. It is also used when seeking the cause of any difference between the model and measurements, and allows us to focus this search on a restricted set of parameters, which control the considered output.

Further, the empirical validation methodology is a function of the given objective and of the type of model under consideration; in our case, the empirical validation must allow us to demonstrate the correct thermal behaviour of the building envelope, in particular at the level of the complex wall including a PV panel.

5.3 Empirical validation

In order to improve the PV model, a comparison has been made between measurements and simulation data (see fig. 11) for the case of the PV panel with a confined air layer. In previous articles, the ISOLAB code has already been validated in many cases by comparisons with other building simulation codes, as well as experimental validations. This comparisons can show advantages and disadvantages of the model. In figures presented below, the main temperatures are compared for the previous cell.

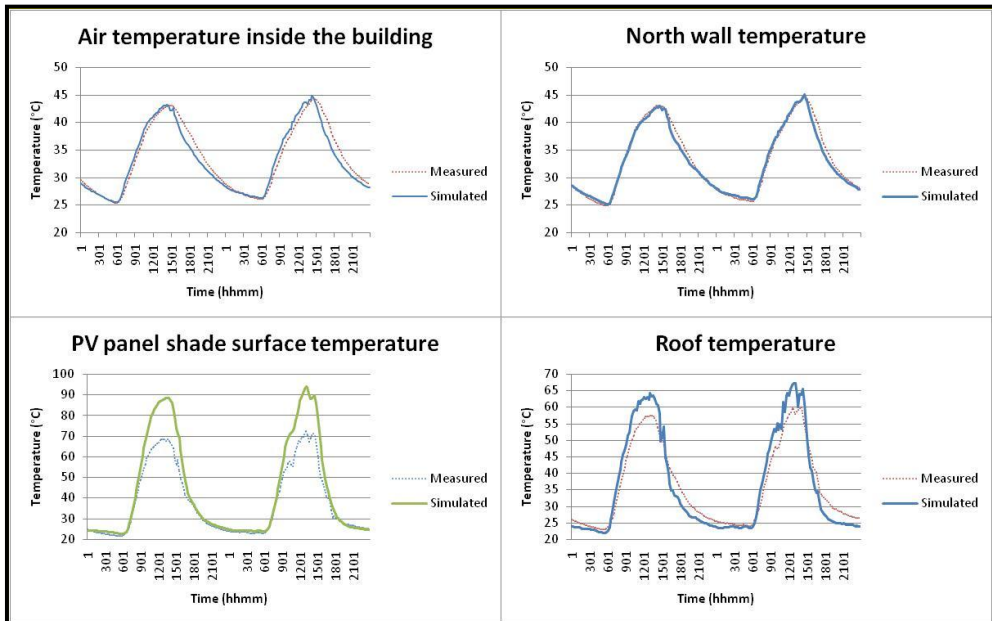

Fig 11. Temperatures of the PV installation with a confined air layer

For the temperatures obtained for the body of the cell, a good agreement is obtained, the average difference of temperature being weak, of the order of 1°C. Nevertheless Figure 11 shows, although the PV model has a good dynamic behaviour in the case of a confined air layer, noticeable differences between the model and the reality of measurements. These differences can be related to:

- Thermo-physical properties (conduction, thermal capacity, transmittivity, absorptivity...) of each PV panel material, which are not exactly known. Industrials did not give details of those properties in order to protect their copyright.
- The precision of the radiative model (of PV panels) or convective model (of air layer) in the PV modelling.

To give elements of answers for these differences between predictions and measurements, a sensitivity analysis was made, as explained in the following paragraph.

5.4 Sensitivity analysis

The sensitivity analysis consists in performing several simulation runs by oscillating each parameter according to a sinusoid over its range of interest. Analyzing the spectrum (Fourier transform or power spectral density) of the output, identification of the most influential factors can be easily derived (Mara, 2000); (Mara et al., 2000); (Mara, 2002).

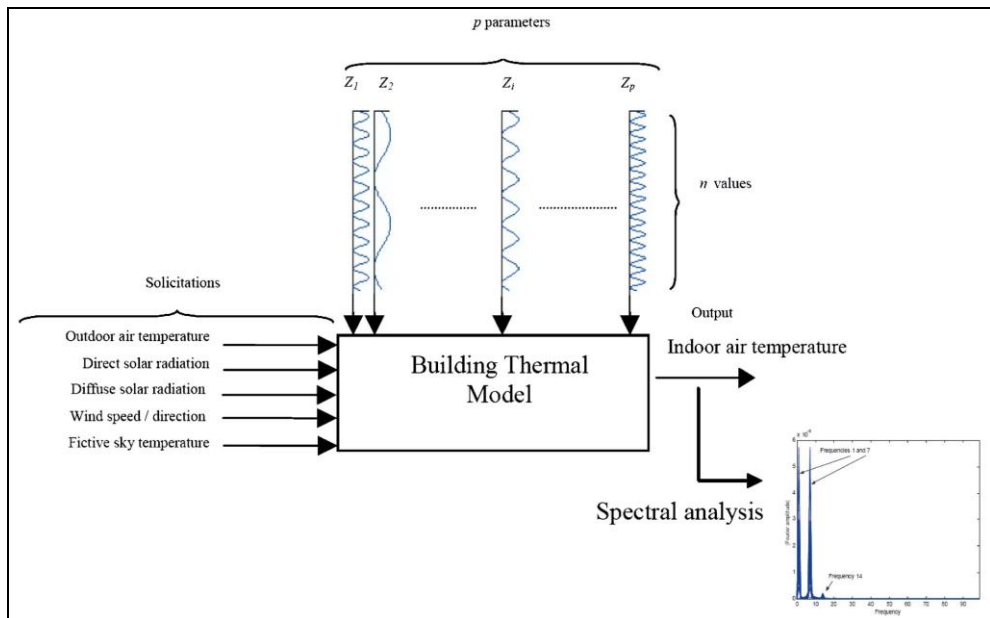

Fig 12. Procedure of sensitivity analysis.

The proposed FAST method (Fast Fourier Amplitude Transform) uses a sinusoidal sampling of parameters around their base value, each parameter having its own frequency, the

variation being applied to a simulation on the other as shown in fig. 12. Thus, the process is analogous to the use of an experimental design where the parameters are varied in each test according to a predetermined pattern, so to sweep the best surface model response.

The sensitivity analysis is composed of three steps:

- The first step that put in evidence the most influential parameters, shown on the figure 13 (Fourier spectrum). For each frequency that corresponds to each parameter it can be shown if it has an effect on the outputs.
- The second step presents principal effects of each parameter on the outputs. It represents the linear effect of each parameter.
- The third step presents non linear effects of parameters on the outputs. Contrary to principal effects, it takes into account the effect of a parameter in interaction with other parameters.

In this study, only principal effects are presented, because non linear effects are negligible compare to principal effects (the maximum interactional effect is about 0.1°C).

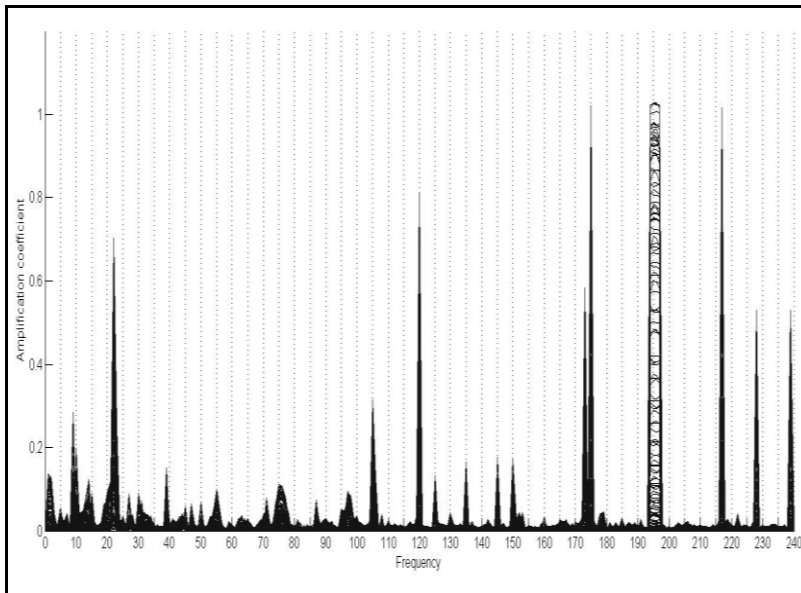

Fig. 13. Fourier spectrum of the sensitivity analysis for the inside air temperature of the building

Parameter numbers	Signication of the parameter
120	Roof azimuth
125	Roof tilt
135	Galvanized steel thickness
145	Galvanized steel density
150	Galvanized steel heat capacity
175	Aluminum thermal conductivity
194	EVAinf transmissivity
195	Silicon transmissivity
196	EVA _{sup} transmissivity
197	Glas transmissivity
217	Aluminum absorptivity
228	Convective heat transfer of the air gap under PV panel

Table. 3. Designation of influential parameters of PV model on temperatures of the building

The sensitivity analysis was run with a thermal simulation of the building during two days in January 2009. A variation of 10% was applied to all parameters contained in the building and PV panel descriptions.

In a First run, the inside air temperature of the building was chosen has the output. Results show that several parameters of the PV thermal model are influential on this temperature (see fig. 13 an fig. 14).

The fig. 13 shows the Fourier spectrum, and also parameters of influence. Fig. 14 shows parameter effects, and the magnitude of influence of each parameter, described by a frequency number (see Table 3).

Because the inconsistency seems to come from the modelling of the PV system (ie the assembly of the PV panel and the roof wall), the sensitivity analysis was made for temperatures of all layers of the PV panel system and for the building inside air temperature.

The analysis emphases thermo-physical parameters like thermal conductivity, heat capacity or transmittivity. These results show that three types of thermal transfer must be described more precisely or in a different way, because they are very influential on the air temperature inside the building:

- the transmission of solar irradiation through the semi-transparent system in the PV panel, and the absorption of solar irradiation by the first opaque layer,
- the thermal conduction through all opaque layers after semi-transparent complex system,
- the convection transfer in air gaps in the PV complex wall (like the air gap besides the PV panel).

Furthermore, optical properties of semi transparent layers and characterization of the flow in inclined air gaps are not easy to visualize or describe. These phenomena have been

described by commonly accepted parameters, but it is not sure it corresponds exactly to reality. So these results seem quite realistic.

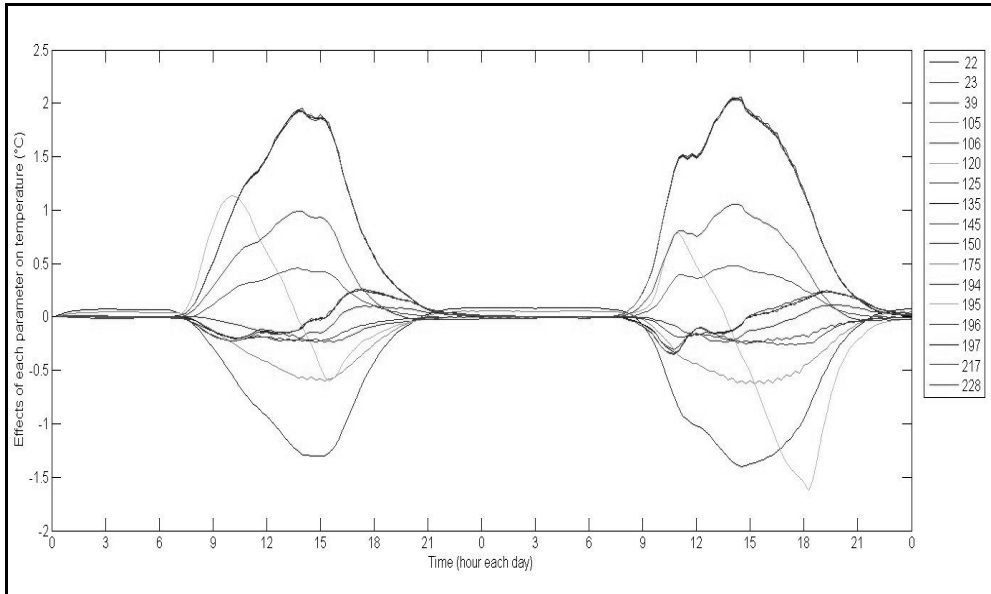

Fig. 14. Principal effect of sensitivity analysis of the inside air temperature of building

Focusing the sensitivity analysis on different layers of the PV complex wall, it can be shown that the most influential parameters are those presented above. Basically, it depends on the transmittivity of all semi-transparent layers through which solar irradiation is transferred, on the conductivity of all opaque layers, and on convective heat transfer coefficients of air gaps of the system.

The next step consists in optimizing parameters of the thermal modelling, as it is introduced as following.

5.5 Optimization

The optimization is the step where the model can be improved and validated. It can be made by using optimization algorithms. In this chapter, we present the use of a free optimization program called “Genopt” (Wetter, 2001). This program was set up to allow anyone to use it with his own simulation code. It has been coupled with many building simulation codes like EnergyPlus, TRNSYS, SPARK, IDA-ICE or DOE-2.

Genopt make the optimization by running simulations of the studied code. It changes values of parameters in the inputs of the program and notes the variation induced on the outputs. As it is shown on fig. 14, it needs only three files to run: the input file, the output file and also the program it has to run. Furthermore, it needs information about the optimization algorithm, studied parameters and the cost function.

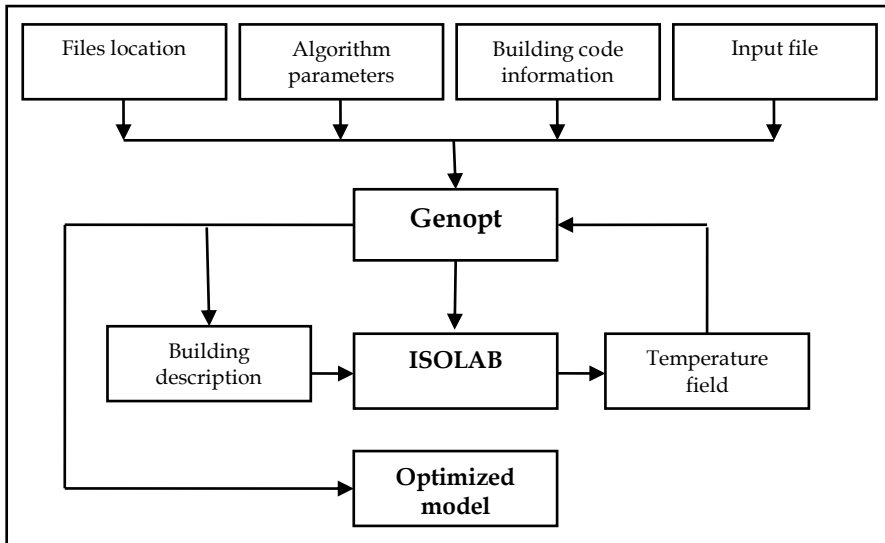

Fig. 14. Synoptic of the coupling of the building simulation code Isolab with Genopt

To use Genopt as it is presented in fig. 14, it is necessary to create a complete standalone simulation code; i.e. a program that does not need the human intervention to run a simulation. This step is particularly complex in our case, because Isolab was made to be used with the presence of a human kind in all steps of the simulation process.

The interfacing between Genopt and Isolab is in the last test phase. The next step will be the optimisation procedure of the PV system, with the precise determination of the best set of parameters, including conductive, convective and radiative aspects.

Finally, the corroboration of the optimised model will terminate the validation procedure, and allow the generalised use of the model for precise building design.

6. Conclusion

6.1 Thermal Performance of BIPV

The review on BIPV has demonstrated that not only a unique physical model exists, capable of predicting the thermal evolution of the building envelope with the influence of photovoltaic systems in various configurations (integrated-façade, integrated-roof, integrated-glazing, etc.). This chapter has presented a semi-detailed model of a fully coupled PV model, integrated in a building simulation code. The model was used to predict the temperature field in the complex wall constituted by the PV system and its support wall. A global validation procedure (including a sensitivity analysis) has been conducted to determine the precision level of the results and has shown that the performance of the BIPV was greatly dependant on the radiative heat transfer within the semi-transparent layers and the convective heat transfer in the fluid layers. Moreover, the opaque layer included in the

system plays also, according to its radiative properties, an important role on the whole behaviour of the system. The main problem is the modelling of convective air-gaps, in which coupled heat transfers arise, the intensity of the coupling being function of the configurations of the photovoltaic installation (angles, thickness and distribution of air spaces in the panel, etc).

6.2 Model validity

Experimentation data was compared to simulation data. This comparison shows that the thermal model has a good dynamic. However, there are some fairly large differences in amplitude for temperatures of the PV complex wall. To provide some answers to this problem, a sensitivity analysis was run and brought to light the most important parameters on the behaviour of the system. An optimisation procedure is planned, to determine the best set of parameters to lead to the best performance of the BIPV. Adjusting these parameters will considerably reduce the observed difference between measurements and predictions, and lead to the validation of the building envelope model. This important step is in progress and will be presented in future works.

6.3 Coupling with PCMs

One possible perspective is to couple the BIPV with MCPs (phase change materials). These are materials capable of changing of physical state within wide ranges of temperatures according to desired applications (building insulation, passive cooling, thermal energy storage, textile industry, etc.).

These materials have the ability to store or to destock a large amount of energy as latent heat during phase change liquid-solid. They can be classified into three broad categories:

- The MCP organic (paraffin and fatty acid)
- The MCP inorganic (hydrated salt)
- The MCP eutectic (organic-organic, organic-inorganic, inorganic-inorganic)

The choice of MCPs is based on a number of factors such as latent and sensible heat, thermal conductivity in liquid and solid phases but also the impact on the overall thermal performance of the entire system and its cost.

The coupling of the PCM with BIPV could be considered as liquid-solid phase change to reduce the temperature rise within the BIPV but also increase their performance and their life.

6.4 Toward zero net energy buildings

The building simulation code used for this study henceforth includes a generic model, fully coupled, for the complete modelling of the integration of PV panels in buildings. More and more used in the world, as a means of electricity production using renewable energy, PV systems are of great potential and are subject to numerous research programs. Their inclusion in building envelopes opens the way for zero net energy constructions, whose potential in terms of energy consumption and reduction of global warming is more and more recognised. In a near future, with constant developments and improvements, our

building simulation code will be able to predict the energetic behaviours of zero net energy buildings and thus the evaluation and optimisation of their performances.

7. References

- Bazilian MD, Prasad D. Thermal and electrical performance monitoring of a combined BIPV array and modular heat recovery system. In: ISES Solar World Congress Adelaide, Australia, 2001
- Bazilian MD. Australia's first BiPV/thermal test facility (an ACRE funded research project). In: PV in Europe, Rome, 2002
- Bigot, D.; Miranville, F.; Fakra, A., H.; Boyer, H. (2009). A nodal thermal model for photovoltaic systems: impact on building temperature field elements of validation for humid climatic conditions. *Energy and Buildings*, Vol. 41, June 2009, 1117-1126
- Cherruault, J; Wheldon, A.; (2001). Evaluation of a BIPV roof, designed for expandability and using coloured cells. DTI Sustainable Energy Programmes. DTI Pub/URN 01/1395, ETSU S/P2/00297/REP, 80 p. University of Reading, Renewable Energy Helpline
- Chow, T., T.; He, W.; Chan, A., L., S.; Fong, K., F.; Lin, Z.; Li, J. (2008). Computer modelling and experimental validation of a building-integrated photovoltaic and water heating system. *Applied Thermal Engineering*, Vol. 28, October 2007, 1356-1364
- Fung, T., Y.; Yang, H. (2008). Study on thermal performance of semi-transparent building-integrated photovoltaic glazing's. *Energy and Buildings*, Vol. 40, February 2007, 341-350
- Guiavarch, A. ; Peuportier, B. (2006). Photovoltaic collectors efficiency according to their integration in buildings. *Solar Energy*, January 2006, Vol. 80 issue 1, 65-77
- Jie, J.; Hua, Y.; Wei, H.; Gang, P.; Jianping, L.; Bin, J. (2007). Modeling of a novel Trombe wall with PV cells. *Building and Environment*, Vol. 42, January 2006, 1544-1552
- Jiménez, M., J.; Madsen, H., Bloem, J., J.; Dammann, B. (2008). Estimation of non-linear continuous time models for the heat exchange dynamics of building integrated photovoltaic modules. *Energy and Buildings*, Vol. 40, February 2007, 157-167
- Judkoff, R.D., Neymark, J.S. A Procedure for Testing the Ability of Whole Building Energy Simulation Programs to Thermally Model the Building Fabric. *Journal of Solar Energy Engineering, Transactions of ASME*, Volume 117, pp. 7-15, 1995
- Kondratenko IV. Urban retrofit building integrated photovoltaics [BIPV] in Schotland, with particular reference to double skin facades. PhD thesis, University of Glasgow, 2003
- Kropf S. PV/T Schiefer, Optimierung der Energieeffizienz von Gebäuden durch gegenseitige Ergänzung von Simulation und Messung am Beispiel der Hinterlüftung gebäudeintegrierter Photovoltaik. PhD report, ETH Zurich, 2003
- Mara, T., Boyer, H., Garde, F. and Adelard L., *Présentation et Application d'une Technique d'Analyse de Sensibilité Paramétrique en Thermique du Bâtiment*, Société Française de Thermique SFT 2000, Lyon, France. p.795-800. 2000.
- Mara, T., Garde, F., Boyer, H., Mamode M.. Empirical validation of the thermal model of a passive solar test cell. *Energy and Buildings*. Vol.1320, p.1 - 11. 2000.
- Mara, T., Boyer, H., Garde, F. Parametric Sensitivity Analysis of test cell thermal model using spectral analysis. *ASME Journal of Solar Energy Engineering*. Vol.124, p.237 - 242. (2002)

- Mei, L.; Infield, D., G.; Gosttschalg, R.; Loveday, D. L.; Davies, D.; Berry, M. (2009). Equilibrium thermal characteristics of building integrated photovoltaic tiled roof. *Solar Energy*, Vol. 83, July 2009, 1893-1901
- Miranville, F. Contribution à l'Etude des Parois Complexes en Physique du Bâtiment. Thesis. University of La Reunion, La Reunion (France). 2002.
- Miranville F., Boyer H., Mara T., Garde F. On the thermal behaviour of roof-mounted radiant barriers under tropical and humid climatic conditions. *Energy and Buildings*, Volume 35, Issue 10, November 2003, Pages 997-1008
- Norme ISO-9869-1994, Isolation thermique - Elements de construction - Mesures in-situ de la resistance thermique et de la transmittance thermique
- Nynne, F.; Maria, J., J.; Hans, B.; Henrik, M. (2009). Modelling the heat dynamics building integrated and ventilated photovoltaic modules. *Energy and Buildings*, Vol. 41, May 2009, 1051-1057
- Park, K., E.; Kang, H., G.; Kim, H., I.; Yu, G., J.; Kim, J., T. (2010). Analysis of thermal and electrical performance of semi - transparent photovoltaic module. *Energy*, Vol. 35, July 2009, 2681 - 2687
- Siegel R. 1992. *Thermal Radiation Heat Transfer*. Hemisphere, Washington.
- Skoplaski, E.; Palyvos, J.,A. (2009). Operating temperature of photovoltaic modules: A survey of pertinent correlations. *Renewable Energy*, Vol. 34, June 2008, 23-29
- Steven, V, D.; Benjamin, F. (2010). Active thermal insulators: finite elements modelling and parametric study of thermoelectric modules integrated into a double pane glazing system. *Energy and Buildings*, Vol. 42, February 2010, 1156-1164
- Tian, W.; Wang, Y.; Xie, Y.; Wu, D.; Zhu, L.; Ren, J. (2007). Effect of building integrated photovoltaic on microclimate of urban canopy layer. *Building and Environment*, Vol. 42, February 2006, 1891-1901
- Trinuruk, P.; Sorapipatana, C.; Chenvidhya, D. (2009). Estimating operating cell temperature of BIPV modules in Thailand. *Renewable Energy*, Vol. 34., February 2009, 2515-2523
- Wang, Y., Tian, W.; Ren, J.; Zhu, L.; Wang, Q. (2006). Influence of a building's integrated-photovoltaic on heating and cooling loads. *Applied Energy*, Vol. 83, December 2005, 989-1003
- Wetter, M. GenOpt - A generic optimization program. In R. Lamberts, C. O. R. Negrao, and J. Hensen, editors, *Proc. of the 7th IBPSA Conference*, volume I, pages 601-608. Rio de Janeiro, 2001.
- Xu, X.; Dessel, V., S. (2008). Evaluation of a prototype active building envelope window - system. *Energy and Buildings*, Vol. 40, February 2007, 168-174
- Zondag, H., A. Combined PV-air collector as heat pump air preheater. *Staffelstein*, 2001
- Zondag, H., A. (2008). Flat-Plate PV-Thermal collectors and systems: A review. *Renewable and Sustainable Energy Reviews*, Vol. 12, December 2005, 891-959