



**HAL**  
open science

# IR Thermography measurement of convective heat transfer coefficients with periodic excitation by Joule effect applied to the estimation of compact heat exchanger efficiency

P. Leblay, J.F. Henry, D. Caron, Denis Leducq, André Bontemps, L. Fournaison

## ► To cite this version:

P. Leblay, J.F. Henry, D. Caron, Denis Leducq, André Bontemps, et al.. IR Thermography measurement of convective heat transfer coefficients with periodic excitation by Joule effect applied to the estimation of compact heat exchanger efficiency. 3rd IIR Workshop on Refrigerant Charge Reduction in Refrigerating Systems, Oct 2012, Valence, Spain. 10 p. hal-00765914

**HAL Id: hal-00765914**

**<https://hal.science/hal-00765914>**

Submitted on 17 Dec 2012

**HAL** is a multi-disciplinary open access archive for the deposit and dissemination of scientific research documents, whether they are published or not. The documents may come from teaching and research institutions in France or abroad, or from public or private research centers.

L'archive ouverte pluridisciplinaire **HAL**, est destinée au dépôt et à la diffusion de documents scientifiques de niveau recherche, publiés ou non, émanant des établissements d'enseignement et de recherche français ou étrangers, des laboratoires publics ou privés.

**3<sup>rd</sup> IIR Workshop on Refrigerant Charge Reduction in Refrigerating Systems**  
**IR THERMOGRAPHY MEASUREMENT OF CONVECTIVE HEAT**  
**TRANSFER COEFFICIENTS WITH PERIODIC EXCITATION BY JOULE**  
**EFFECT APPLIED TO THE ESTIMATION OF COMPACT HEAT**  
**EXCHANGER EFFICIENCY**

**P. LEBLAY<sup>(a)</sup>, J.-F. HENRY<sup>(b)</sup>, D. CARON<sup>(b)</sup>, D. LEDUCQ<sup>(a)</sup>, A. BONTEMPS<sup>(c)</sup>, L. FOURNAISON<sup>(a)</sup>**

<sup>(a)</sup> LGP2ES Irstea-GPAN, 1, rue Pierre-Gilles de Gennes, CS 10030, 92761 Antony Cedex, France, [patrick.leblay@irstea.fr](mailto:patrick.leblay@irstea.fr)

<sup>(b)</sup> University of Reims Champagne-Ardenne, URCA/GRESPI/Thermomécanique, UFR Sciences, 51687 Reims Cedex 2, France, [jf.henry@univ-reims.fr](mailto:jf.henry@univ-reims.fr)

<sup>(c)</sup> LEGI, UMR 5519, Domaine Universitaire BP 53, 38041 Grenoble Cedex 9, France, [andre.bontemps@cea.fr](mailto:andre.bontemps@cea.fr)

### ABSTRACT

A new methodology has been developed to characterize the loss of efficiency of heat exchangers due to a maldistribution of the two-phase flow. The approach consists to measure the distribution of the local heat transfer coefficients with a non-intrusive and fast measurement method, based on a periodic excitation by Joule effect and infrared thermography measurement. An analytical model of the heat transfer is used to deduce heat transfer coefficients from the amplitude of the outside tube temperature fluctuations amplitude and heat flux measurement. This method, initially developed for a cylindrical tube, has been also applied on various tube shapes, including microchannel flat tubes. As an example, the method is used to evaluate the heterogeneity of distribution of an air-water mixture in a compact heat exchanger composed of seven multiport flat tubes. The distribution of heat transfer coefficients was studied for a vertical downward header and horizontal channels and for mass flux from  $29 \text{ kg}\cdot\text{m}^{-2}\cdot\text{s}^{-1}$  to  $116 \text{ kg}\cdot\text{m}^{-2}\cdot\text{s}^{-1}$  and for quality from 0.10 to 0.70. Results are presented and discussed.

### 1. INTRODUCTION

Brazed aluminium heat exchangers are composed of flat tubes on the refrigerant side and louver fins on the air side. The flat tubes are grouped within a header, to use the heat exchanger in a parallel flow configuration. These exchangers have some advantages compared to the heat exchangers with round tubes, such as charge reduction and higher heat transfer efficiency.

But a reduced diameter implies a great number of parallel circuits (Hrnjak, 2002). Conventional distributors are thus not suitable to small-channel heat exchangers. Increasing the number of tubes and reducing the hydraulic diameter implies a refrigerant distribution much more penalizing for these exchangers than for round tube heat exchangers. Indeed, according to Kulkarni *et al.* (2004), an uneven distribution may result in a performance reduction up to 20 %.

The major influence of geometrical parameters on distribution (Webb and Chung, 2005) implies disposing of a non intrusive measurement method respecting the heat exchanger geometry. Indeed, investigating two-phase distribution in a small-channel heat exchanger requires an appropriate measurement technique.

Typically, distribution between channels is studied in terms of flow rate of each phase in every tube. Bernoux *et al.* (2000) and later Ahmad *et al.* (2009) have thus equipped every tube with its own flowmeter and condenser to measure the distribution of two-phase R-113 and HFE-7100 in the whole exchanger. This protocol has also been used by Poggi *et al.* (2009) for two-phase HFE-7100.

Watanabe (1995) and later Cho and Cho (2006, 2004) used a variant of this system, with separators of liquid and gas followed by liquid and gas flowmeters.

Such a system, even if reliable, can't be easily translated to a typical heat exchanger configuration. Indeed, the influence of the outlet header isn't taken into account in this case. Moreover, this method is reasonably adapted for exchanger with only a few channels, considering the need to dispose of one or two flowmeters per channel.

### 3<sup>rd</sup> IIR Workshop on Refrigerant Charge Reduction in Refrigerating Systems

Investigations of Kim and Lee (2006) stand on the same principle. The heat exchanger was separated at its middle to include a derivation system. With this modification, distribution of two-phase fluid can be estimated by measuring flow rate and quality at each channel outlet successively. Hwang *et al.* (2007) used a similar system to measure the distribution of two-phase R-410a.

This protocol takes into account the effect generated by the outlet header. However, this system requires a pressure drop measurement to avoid the influence of sampling on distribution.

For liquid distribution, O'halloran *et al.* (2004) used PIV (Particle Image Velocimetry) to study the distribution. This method provides good results but was not suitable for two-phase measurement.

Distribution was also estimated by measuring the evaporator air temperature contours. Shi *et al.* (2011) studied the influence of geometry on the distribution. Evaporator air temperature contours was measured with thermocouples and authors relied on these data to support their observations.

IR<sup>1</sup> thermography was used by Sa *et al.* (2003) to provide information on two-phase distribution. Transient measurements were performed with various exchanger configurations. Knowledge of transient temperature distribution, together with quantitative data such as heat transfer rate and pressure drop, were used to select the best configuration.

The present paper focuses on the development of a method designed to measure the efficiency of heat exchanger. The measurement of heat transfer coefficient allows qualifying the efficiency of the distribution. The method is based on an infrared thermography measurement of the flat tubes surface temperature under a periodic heat flux by Joule effect, and a mathematical model to deduce the heat transfer coefficient.

## 2. MEASUREMENT PRINCIPLE

The objective of the measurement performed in the GRESPI laboratory is to estimate heat transfer coefficients between the flowing water and the inlet wall of a pipe. The studied exchanger was composed of seven multiport flat tubes. Each tube was heated by Joule effect with a periodic excitation. The heat flux was measured with an ammeter and voltmeters, and the oscillation of the outside surface temperature of the tubes with an IR camera. Heat flux and temperature amplitude were used as entry variables in a model to finally estimate the heat transfer coefficients.

Tubes were electrically heated by a sinusoidal wave DC generator which output voltage was modulated at low frequency ( $f = 0.05$  Hz in this study). Since the tube acts as a pure resistance, the current is itself at the same frequency as the voltage and in phase with it. Their expression is given in eq. (1).

$$\begin{aligned} U &= U_m + U_a \cos(\omega t) \\ I &= I_m + I_a \cos(\omega t) \end{aligned} \tag{1}$$

The power dissipated by Joule effect in the tubes is equal to the product  $U I$  and therefore has three components: a continuous one, one at the excitation frequency  $f$  and one at a frequency twice that of the source. The model takes into account these components.

## 3. MODEL DEVELOPPED

The model developed assimilates the flat tube to a wall, as presented in Figure 1. Thanks to the symmetry condition induced by the geometry, only half the flat tube was considered. The relation between the periodic heating energy and the temperature oscillations of the outside wall is composed of the heat conduction equation inside the wall and of the boundary conditions. These conditions are a convective heat flux imposed on the inner surface of the tube by the fluid flow and a condition of adiabaticity on the outer surface. Indeed, heat losses by external convection and radiation are negligible compared to the heat flux transferred to the fluid and will be neglected here. To take into account the influence of the fins formed by small-channel separations, two different surfaces were added to the model. Surfaces  $s_1$  and  $s_2$  were considered respectively for conduction and for convection.

---

<sup>1</sup> Infrared

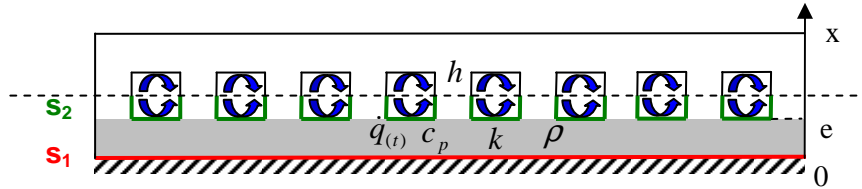

Figure 1: Representation of the multiport flat tube and related quantities

Considering the low heat flux provided by the power supply, oscillating from 5 W to 35 W, a second assumption is a constant fluid temperature. The third hypothesis concerns the independence of the thermodynamic properties of the material and of the convection coefficient to the temperature. The fourth and last hypothesis is a 1-D temperature variation. Heat transfers in any other direction than the x axis are then neglected.

The system to solve, composed of the energy equation and boundary conditions, is given in eq. (2).

$$\begin{cases} \frac{\partial^2 T_{w(x,t)}}{\partial x^2} - \frac{l}{a} \frac{\partial T_{w(x,t)}}{\partial t} = -\frac{\dot{q}(t)}{k} \\ x = e \quad -k s_l \left. \frac{\partial T_{w(x,t)}}{\partial x} \right|_{x=e} = h s_2 (T_{w(e,t)} - T_{f,in}) \\ x = 0 \quad -k \left. \frac{\partial T_{w(x,t)}}{\partial x} \right|_{x=0} = 0 \end{cases} \quad (2)$$

Temperature, like power, has three components: a continuous one, one at the excitation frequency, and one at a frequency twice the excitation frequency. By defining eq. (3),

$$\theta_{(x,t)} = (T_{w(x,t)} - T_{f,in}) \quad (3)$$

and assuming a periodic established state, we obtain eq. (4)

$$\theta_{(x,t)} = \theta_{c(x)} + \theta_{\omega(x)} \exp(j(\omega t + \varphi)) + \theta_{2\omega(x)} \exp(j(2\omega t + \varphi)) \quad (4)$$

and (5)

$$\dot{q}(t) = \dot{q}_c + \dot{q}_\omega \exp(j\omega t) + \dot{q}_{2\omega} \exp(j2\omega t) \quad (5)$$

where  $\varphi$  is the phase shift between the temperature and the heat source. The resolution of the system provides the expression of  $\theta_{w,\omega(x)} \exp(j\varphi)$ , given in eq. (6) and (7).

$$\theta_{w,\omega(x)} \exp(j\varphi) = \frac{\dot{q}_\omega}{m_\omega^2 k} \left[ 1 - \frac{\left( 1 - \frac{m_\omega^2 k V}{\dot{m}_f c_{p,f}} \right) ch(m_\omega x)}{\frac{k m_\omega s_l}{h} \frac{s_1}{s_2} sh(m_\omega e) + ch(m_\omega e)} \right] \quad (6) \quad \text{with } m_\omega = \sqrt{\frac{j\omega}{a}} \quad (7)$$

The same resolution was applied to the system at twice the excitation frequency to obtain the expression of  $\theta_{2\omega(x)} \exp(j\varphi)$ . Knowing eq. (8),

$$\theta_{(x)} = \left| \theta_{\omega(x)} \exp(j \varphi) + \theta_{2\omega(x)} \exp(j \varphi) \right| \quad (8)$$

an evaluation of the  $h$  value is finally obtained by minimizing  $\mathcal{E}$  such as given in eq. (9).

$$\mathcal{E} = \left| \theta_{(0)exp} - \theta_{(0)} \right| \quad (9)$$

where  $\theta_{(0)exp}$  is the experimental amplitude of the temperature oscillations. So, the knowledge of the properties of the tube material  $c_p$ ,  $k$ ,  $\rho$ , the excitation frequency  $f$ , the power densities  $\dot{q}_\omega$  and  $\dot{q}_{2\omega}$  and the amplitude of the measured temperature  $\theta_{(0)exp}$  allow us to determine the convective heat transfer coefficient  $h$ .

#### 4. EXPERIMENTAL FACILITY

The exchanger in which the heat transfer coefficient measurements were carried out was composed of two headers and seven multiport flat tubes. Both headers were acrylic round tubes of 2.1 cm diameter. They were transparent to allow flow pattern visualization. The tubes were made of aluminium and their geometry is presented in Figure 2. The tubes were connected to the headers with a pitch of 1 cm and with an intrusion depth of 1 cm. The exchanger itself is positioned to be supplied in a vertically downward way.

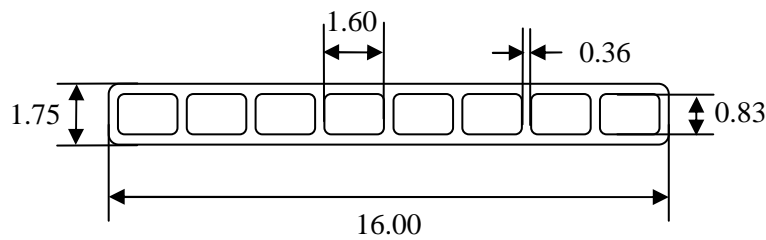

Figure 2: Cross-sectional view of the multiport flat tube (unit: mm)

The two main devices needed to estimate heat transfer coefficients were a power supply to generate periodic excitation by Joule effect and a scanning device to monitor and measure the surface temperature. A length of 30 cm was thus heated by Joule effect at a frequency of 0.05 Hz. This effect was located between electrodes connected to the power supply with copper cables. To supply the complete exchanger, tubes were connected in series with copper electrodes, as presented in Figure 3. A clamp ammeter and voltmeters were connected to a data logger to measure respectively electric current in the exchanger and voltage in each tube.

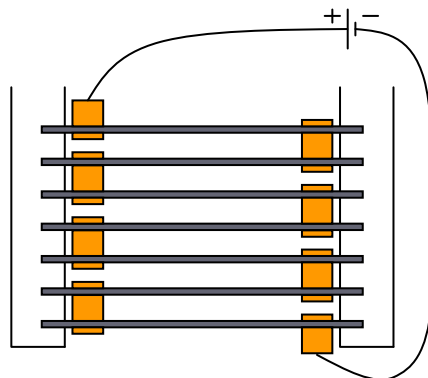

Figure 3: Electrical assembly

To measure the distribution of heat transfer coefficients for a complete heat exchanger, the surface temperature was measured by IR thermography. The thermographic camera (Titanium Cedip) measured the temperature on the external surface of the tubes at a frequency of 2 Hz. This allowed the capture of 400

### 3<sup>rd</sup> IIR Workshop on Refrigerant Charge Reduction in Refrigerating Systems

points in 200 seconds and thus 10 periods. The tube external surface was painted in black in order to increase and homogenize their emissivity. The area observed by the camera was about 20 cm long and was located in the middle of the area heated by Joule effect. The area considered for calculation, presented in Figure 4, is a part of each tube that is about 1.2 cm wide and 2.4 cm high. To measure the temperature evolution of the complete exchanger, the thermographic camera was inclined with an angle of 45 °.

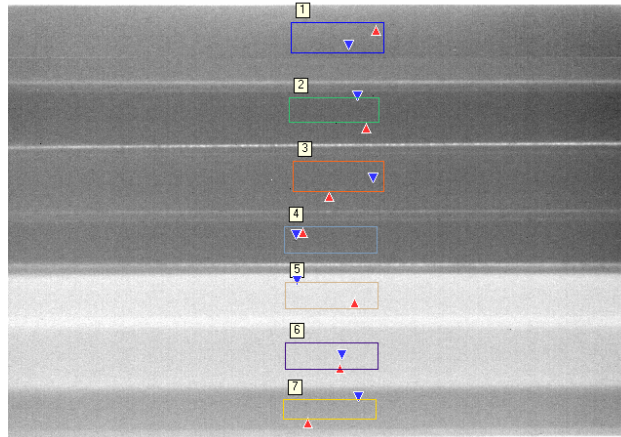

Figure 4 : Area considered

The hydraulic circuit is presented in Figure 5. Air and water were used as working fluid. The two fluids were mixed through a static mixer to have an homogeneous mixture. Water and air flow rate were controlled by valves. Both fluid flow rates were measured by a corresponding flowmeter. Total inlet mass flux and quality of air-water ranged from  $29 \text{ kg.m}^{-2}.\text{s}^{-1}$  to  $116 \text{ kg.m}^{-2}.\text{s}^{-1}$  and 10 % to 70 %, respectively. A thermocouple, located at the outlet of the exchanger, measured the water temperature during experiments in order to check that the water temperature remained constant during the test. The tank temperature was controlled using a thermocouple connected to the data logger.

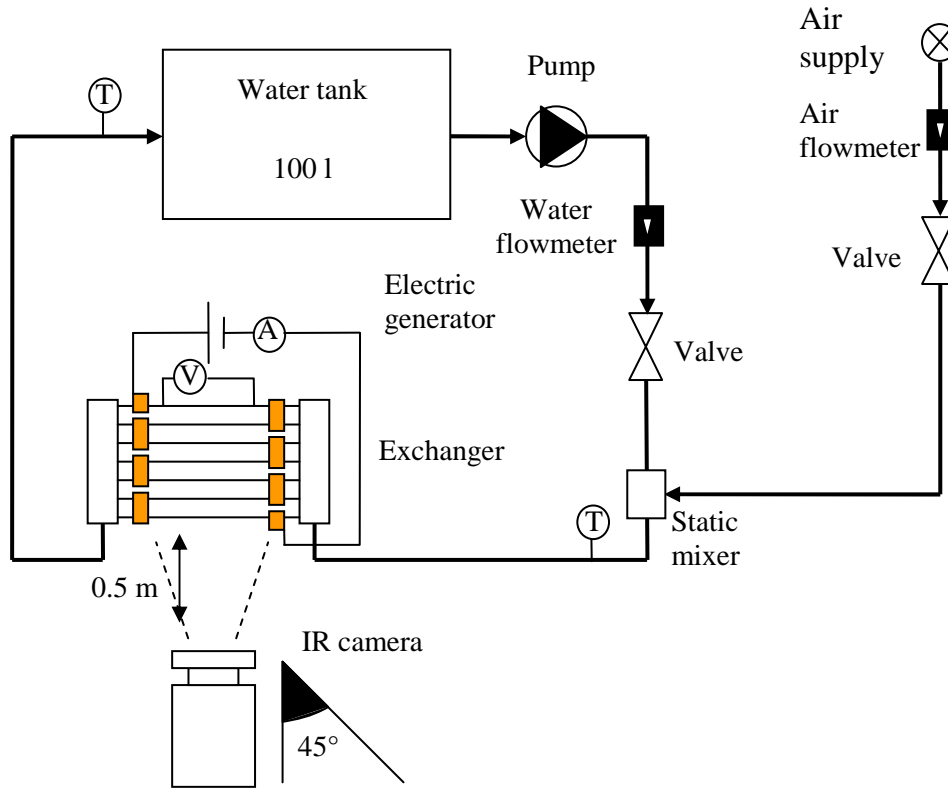

Figure 5: Hydraulic circuit

## 5. EXPERIMENTAL RESULTS

In studies focused on the measurement of liquid and gas distribution, the flow rate in each channel is evaluated in terms of liquid and gas flow ratio in each channel. The flow ratio  $\dot{m}_i^*$  is the ratio of the flow rate of the phase considered  $\dot{m}_i$  inside the tube number  $i$  over the mean flow rate of this phase. It is given in eq. (10).

$$\dot{m}_i^* = \frac{\dot{m}_i}{\sum_{j=1}^N \dot{m}_j / N} \quad (10)$$

Similarly, to compare the distribution of heat transfer coefficients obtained for various flow rates and quality, results are presented here in terms of Nusselt ratio. The Nusselt ratio  $Nu_i^*$  of the tube number  $i$  is the ratio of the Nusselt number measured  $Nu_i$  on the tube  $i$  over the mean Nusselt number calculated for all the tubes, given by eq. (11).

$$Nu_i^* = \frac{Nu_i}{\sum_{j=1}^N Nu_j / N} \quad (11)$$

We thus have a relative comparison of the heat transfer obtained along the header, with a value of 1 indicating a homogeneous distribution.

The effect of mass flux on heat transfer distribution for a vertical downward header is presented in Figure 6. It appears that, whatever the mass flux, the last channels are characterized by greater heat transfer. Heat transfers are almost evenly distributed for the tubes one to five.

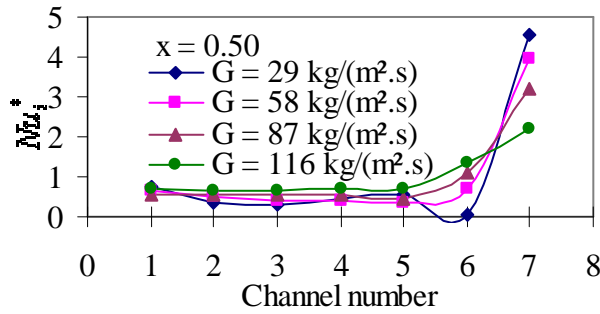

Figure 6: Effect of mass flux on Nusselt number distribution along the header for air-water

Poggi *et al.* (2009) measured distribution obtained for a similar vertical downward header. Their results are presented in Figure 7. Distribution of two-phase HFE7100 was studied for a round header connected to eight multiport flat tubes. They have thus shown that liquid particles hitting the first tube are projected up to the bottom of the header. Liquid accumulated thus at the bottom of the header and supplies mainly the last tubes. The gas phase is evenly distributed.

The results of Poggi *et al.* (2009) are thus consistent with ours. Indeed, with a homogeneous gas distribution, heat transfers are mainly linked to liquid distribution. High liquid distribution at the bottom of the header implies thus high heat transfers.

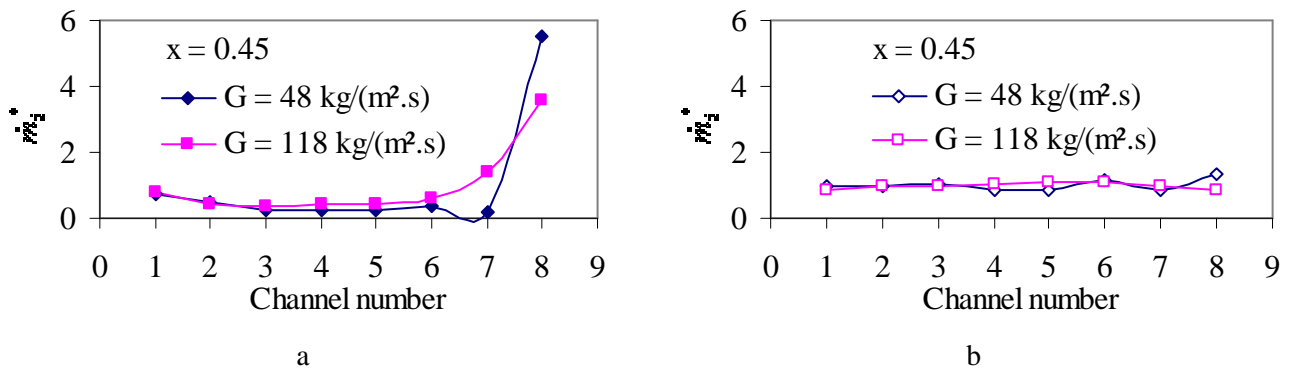

Figure 7: Effect of mass flux on flow distribution of liquid (a) and gas (b) along the header

The effect of quality on distribution of heat transfer is presented in Figure 8. It appears that, for a low quality ( $x = 0.10\%$ ), the latest tubes are oversupplied at the expense of the tubes 2 to 5. For an intermediate quality, the distribution of heat exchange is homogeneous for the five first tubes and sharply increases for the last two. Finally, for a high quality ( $x = 0.70$ ), the distribution of heat exchange is homogeneous for the four first tubes, falling for the fifth and increasing for the last two.

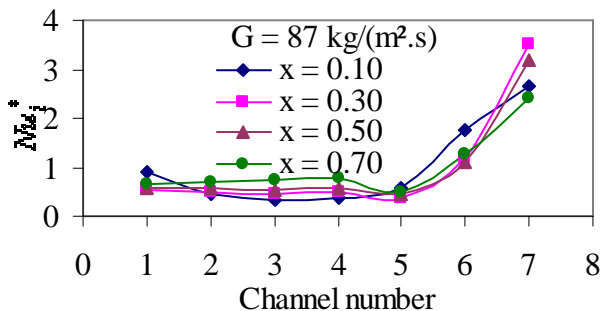

Figure 8: Effect of quality on Nusselt number distribution along the header for air-water



### 3<sup>rd</sup> IIR Workshop on Refrigerant Charge Reduction in Refrigerating Systems

Results obtained by Poggi *et al.* (2009) on the influence of quality on distribution are presented in Figure 9. More pronounced effect is observed in this study. Indeed, increasing quality makes the liquid supplying of all the tubes reduced in favour of the last ones. For a lower quality, the height of liquid accumulated at the bottom of the header is more important. Gas distribution, while relatively homogeneous, improves with the increase of the quality.

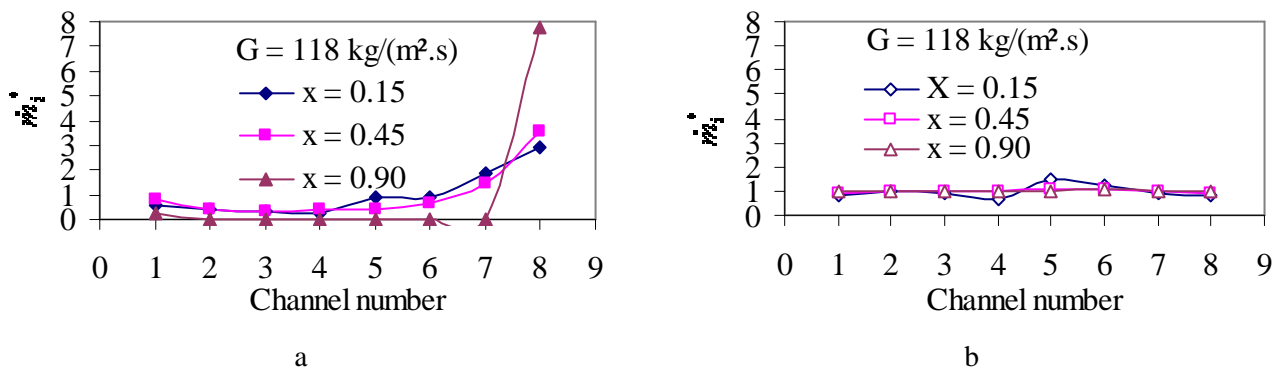

Figure 9: Effect of quality on flow distribution of liquid (a) and gas (b) along the header

The difference between the two results regarding the influence of this parameter may be related to the fluid used. Indeed, the density ratio between phases is much smaller in the case of an air-water mixture than in the case of HFE-7100 (0.0012 and 0.0070 respectively). Air velocity is much higher than water velocity. Some liquid particles are carried away by the air passing through the first tubes. In the case of HFE-7100, this phenomenon is less important.

Moreover, the heat exchanger used by Poggi *et al.* (2009) did not include outlet header. Thus, the dragged effect is increased in our case, the outlet header generating a suction phenomenon.

## 6. CONCLUSION

A method has been developed to measure the convective heat transfer coefficient in a tube. This method is based on a modulated heat flux generated by Joule effect. In this way, the measurement of the amplitude of the tube outside wall temperature with an IR thermographic camera allows to determine internal heat transfer coefficients through a simple analytical model or by using commercial software. The simplicity of the model allows appliance to more complex shaped tubes. This flexibility makes it a perfect tool for controlling series of elements with a similar shape.

This method has several advantages. First, it is a non-intrusive measurement method. It enables heat transfer differences to be estimated without requiring knowledge of the flow rate, temperature or properties of the fluid. Moreover, it does not require a high heat flux, thus avoiding strong perturbation of the fluid properties. The use of infrared thermography allowed us measuring heat transfer on several tubes connected in parallel. In this way, the heat transfer distribution over the entire surface of a heat exchanger could be analyzed.

Among insights, lock-in thermography could be an additional tool. In this way, the thermograms could be treated using a synchronous detection algorithm to obtain complete maps of amplitude and phase. These can then be correlated with exchange coefficient maps.

## 7. ACKNOWLEDGEMENTS

This work has been supported by the Cetim foundation as part of the research project “Two Phase Flow Distribution in a Compact Heat Exchanger”.

## NOMENCLATURE

$a$	thermal diffusivity $a = k / (\rho c_p)$	$(\text{m}^2 \cdot \text{s}^{-1})$	Subscripts
$c_p$	specific heat capacity	$(\text{J} \cdot \text{kg}^{-1} \cdot \text{K}^{-1})$	$a$ alternating

Corresponding author: P. Leblay  
 Phone: + 33 (0)1 40 96 65 78  
 E-mail address: Patrick.leblay@irstea.fr

### 3<sup>rd</sup> IIR Workshop on Refrigerant Charge Reduction in Refrigerating Systems

$f$	frequency	(s <sup>-1</sup> )	$c$	continuous part
$G$	mass flux	(kg.m <sup>-2</sup> .s <sup>-1</sup> )	$exp$	experimental
$h$	heat transfer coefficient	(W.m <sup>-2</sup> .K <sup>-1</sup> )	$f$	fluid
$j$	imaginary number such as $j^2 = -1$	(-)	$in$	inlet
$I$	intensity	(A)	$m$	mean
$k$	thermal conductivity	(W.m <sup>-1</sup> .K <sup>-1</sup> )	$w$	wall
$\dot{m}$	mass flow rate	(kg.s <sup>-1</sup> )	$\omega$	excitation angular frequency
$\dot{q}$	heat flow rate by unit of volume	(W.m <sup>-3</sup> )	$2 \omega$	twice the excitation angular frequency
$s$	surface	(m <sup>2</sup> )		
$T$	temperature	(K)		
$t$	time	(s)		
$U$	voltage	(V)		
$\varepsilon$	minimization criterion	(-)		
$\theta$	reduced temperature	(K)		
$\rho$	density	(kg.m <sup>-3</sup> )		
$\varphi$	phase delay	(rad)		
$\omega$	angular pulsation $\omega = 2 \pi f$	(rad.s <sup>-1</sup> )		

#### REFERENCES

1. Hrnjak, P., Microchannel heat exchangers as a design option for charge reduction in NH3 and HC systems. *Zero Leakage - Minimum Charge*, 2002: p. 111-118.
2. Kulkarni, T., Bullard, C.W., and Cho, K., Header design tradeoffs in microchannel evaporators. *Applied Thermal Engineering*, 2004. **24**(5-6): p. 759-776.
3. Webb, R.L. and Chung, K., Two-phase flow distribution to tubes of parallel flow air-cooled heat exchangers. *Heat Transfer Engineering*, 2005. **26**(4): p. 3-18.
4. Bernoux, P., Etude de la distribution d'un mélange liquide-vapeur à l'entrée des échangeurs de chaleur., in "Mécanique-Energétique". 2000, Université Henri Poincaré: Nancy. p. 240.
5. Ahmad, M., Berthoud, G., and Mercier, P., General characteristics of two-phase flow distribution in a compact heat exchanger. *Int. J. Heat and Mass Transfer*, 2009. **52**(1-2): p. 442-450.
6. Poggi, F., Macchi-Tejeda, H., Leducq, D., Maréchal, A., and Bontemps, A. Experimental and numerical study of the distribution of a single-phase flow in a small channel heat exchanger. in *IIR 1st Workshop on Refrigerant Charge Reduction, Cemagref Antony, France, 2009*. 2009.
7. Watanabe, M., Katsuta, M., Nagata, K., and Sakuma, K., General characteristics of two-phase flow distribution in a multipass tube. *Heat Transfer - Japanese Research*, 1995. **24**(1): p. 32-44.
8. Cho, H. and Cho, K., Two-phase flow distribution and pressure drop in microchannel tubes under non-heating and heating conditions. *Nanoscale and Microscale Thermophysical Engineering*, 2006. **10**(3): p. 233-247.
9. Cho, H.G. and Cho, K.N., Mass flow rate distribution and phase separation of R-22 in multi-microchannel tubes under adiabatic condition. *Microscale Thermophysical Engineering*, 2004. **8**(2): p. 129-139.
10. Kim, N.H. and Sin, T.R., Two-phase flow distribution of air-water annular flow in a parallel flow heat exchanger. *Int. J. Multiphase Flow*, 2006. **32**(12): p. 1340-1353.
11. Hwang, Y., Jin, D.H., and Radermacher, R., Refrigerant distribution in minichannel evaporator manifolds. *Hvac&R Research*, 2007. **13**(4): p. 543-555.

### 3<sup>rd</sup> IIR Workshop on Refrigerant Charge Reduction in Refrigerating Systems

12. O'Halloran, S.P., Hosni, M.H., Beck, B.T., and Eckels, S.J. Three dimensional velocity measurements in an automotive-size evaporator using particle image velocimetry. in *Proc. ASME Heat Transfer/Fluids Engineering Summer Conference 2004, HT/FED 2004*. 2004. Charlotte, NC.
13. Shi, J., Qu, X., Qi, Z., and Chen, J., Investigating performance of microchannel evaporators with different manifold structures. *Int. J. of Refrig.*, 2011. **34**(1): p. 292-302.
14. Sa, Y.C., Jang, D.Y., Ko, C.S., Oh, S.K., Oh, S.Y., and Chung, B.Y. Flow mal-distribution of flat tube evaporator. in *Proceedings of the 2003 4th Int. Symposium on Heating, Ventilating and Air Conditioning*. 2003. Beijing.