



HAL
open science

Nitrile gas chemistry in Titan atmosphere

Thomas Gautier, Nathalie Carrasco, Arnaud Buch, Cyril Szopa, Ella Sciamma-O'Brien, Guy Cernogora

► **To cite this version:**

Thomas Gautier, Nathalie Carrasco, Arnaud Buch, Cyril Szopa, Ella Sciamma-O'Brien, et al.. Nitrile gas chemistry in Titan atmosphere. *Icarus*, 2011, 213 (2), pp.625-635. 10.1016/j.icarus.2011.04.005 . hal-00756910

HAL Id: hal-00756910

<https://hal.science/hal-00756910>

Submitted on 24 Nov 2012

HAL is a multi-disciplinary open access archive for the deposit and dissemination of scientific research documents, whether they are published or not. The documents may come from teaching and research institutions in France or abroad, or from public or private research centers.

L'archive ouverte pluridisciplinaire **HAL**, est destinée au dépôt et à la diffusion de documents scientifiques de niveau recherche, publiés ou non, émanant des établissements d'enseignement et de recherche français ou étrangers, des laboratoires publics ou privés.

Accepted Manuscript

Nitrile gas chemistry in Titan atmosphere

Thomas Gautier, Nathalie Carrasco, Arnaud Buch, Cyril Szopa, Ella Sciamma-O'Brien, Guy Cernogora

PII: S0019-1035(11)00126-6
DOI: [10.1016/j.icarus.2011.04.005](https://doi.org/10.1016/j.icarus.2011.04.005)
Reference: YICAR 9778

To appear in: *Icarus*

Received Date: 6 January 2011
Revised Date: 7 April 2011
Accepted Date: 7 April 2011

Please cite this article as: Gautier, T., Carrasco, N., Buch, A., Szopa, C., Sciamma-O'Brien, E., Cernogora, G., Nitrile gas chemistry in Titan atmosphere, *Icarus* (2011), doi: [10.1016/j.icarus.2011.04.005](https://doi.org/10.1016/j.icarus.2011.04.005)

This is a PDF file of an unedited manuscript that has been accepted for publication. As a service to our customers we are providing this early version of the manuscript. The manuscript will undergo copyediting, typesetting, and review of the resulting proof before it is published in its final form. Please note that during the production process errors may be discovered which could affect the content, and all legal disclaimers that apply to the journal pertain.

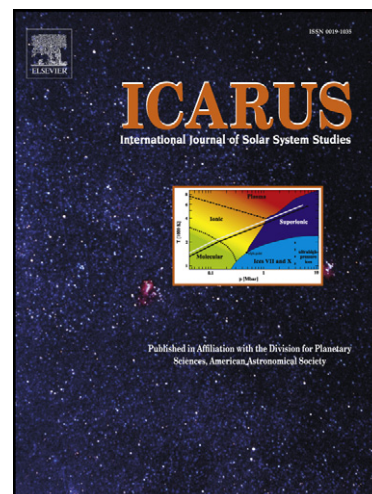

Nitrile gas chemistry in Titan atmosphere

Author List

Thomas Gautier¹, Nathalie Carrasco¹, Arnaud Buch², Cyril Szopa¹, Ella Sciamma-O'Brien¹, Guy Cernogora¹

¹ Université Versailles St Quentin, UPMC Univ. Paris 06, LATMOS, CNRS, 11 Bvd d'Alembert 78280 Guyancourt, France

² LGPM, Ecole Centrale de Paris, Grande voie des Vignes, 92295 Chatenay-Malabry Cedex, France

Editorial correspondence to:

Mr. Thomas Gautier
LATMOS-UVSQ
11 Boulevard d'Alembert
78280 Guyancourt
France
Phone: (0033) 1 80 28 52 77
Fax: (0033) 1 80 28 52 90
E-mail: thomas.gautier@latmos.ipsl.fr

Pages: 41

Equation: 2

Tables: 3

Figures: 7

To be submitted to Icarus

Abstract

This work presents the first study of the gaseous products resulting from the partial dissociation of methane and nitrogen in the PAMPRE experimental setup simulating Titan's atmospheric chemistry.

Using cryogenic trapping, the gaseous products generated from the chemical reactions occurring in the reactor have been trapped. Analyses of these products by gas chromatography coupled with mass spectrometry have allowed the detection and identification of more than 30 reaction products. Most of them are identified as nitrile species, accompanied by aliphatic hydrocarbons and a few aromatics compounds. The observed species are in agreement with the data from the recent Cassini-Huygens mission as well as from other laboratory setups capable of dissociating nitrogen and methane. This work emphasizes the probable importance of nitrogen-bearing compounds in the chemistry taking place in Titan's atmosphere.

Furthermore, a quantification of mono-nitriles with saturated alkyl chains has been performed relatively to hydrogen cyanide and shows a power-law dependence in their concentration. This dependence is consistent with the Cassini-INMS data and Titan's photochemical models.

An empirical relationship has been extracted from our experimental data:

$[C_xH_{2x-1}N] = 100x^{-2}$ where x is the number of carbon atoms in the nitrile molecule.

This relationship can be directly used in order to foretell the concentration of heavier nitriles induced by chemistry in Titan's atmosphere.

ACCEPTED MANUSCRIPT

1 Introduction

The dense atmosphere of Titan, Saturn's largest satellite, is mainly made up of nitrogen and methane (Kuiper 1944). Organic chemical reactions take place in this atmosphere, induced by solar radiation and electrically charged heavy particles coming from Saturn's magnetosphere (Sittler Jr et al. 2009).

This induced organic chemistry is one of the most complex known in the solar system, and leads to the formation of solid organic aerosols responsible for Titan's brownish color.

These aerosols present a major interest for planetary science. First, knowing how they are formed and what their properties are is a clue to better understanding the radiative transfer in planetary atmospheres. Second, the formation process of organic complex molecules presents *de facto* a large interest for exobiology.

In order to understand Titan's atmospheric chemistry, one needs to use several complementary methods. First, Earth and space observations of Titan are used to detect the most predominant species in its atmosphere. In particular, the instruments onboard the current Cassini/Huygens mission (NASA/ESA) have revealed new aspects of Titan's chemistry, discovering many heavy molecules, and negative and positive ions in its upper atmosphere (Israel et al. 2005; Hartle et al. 2006; Yelle et al. 2006; Barnes et al. 2009; Vinatier et al. 2010). Second, numerical models are used to study the chemical pathways and mechanisms that could explain these observations (Wilson and Atreya 2003; Hebrard et al. 2006; Hebrard et al. 2007; Carrasco et al. 2008; Lavvas et al. 2008; Krasnopolsky 2009).

Finally, the last approach to study the chemistry in Titan's atmosphere is the experimental simulation in laboratories. Most of these experiments reproduce a gas mixture close to Titan's atmosphere, or at least to a part of its atmosphere, and then deposit energy into this gas mixture to induce chemistry. Different sources of energy can be used to initiate the dissociation of both molecular nitrogen and methane.

Photochemical experiments expose the gas mixture to a light flux. However, this flux is often not sufficient to dissociate molecular nitrogen because UV radiations below 200 nm are stopped by silica windows. In order to induce a nitrogenous chemistry, these experiments often have to introduce nitrogenous reactive species, such as HCN or HC_3N , in the reactive gas mixture (Clarke et al. 2000; Tran et al. 2005; Barnun et al. 2008).

In order to dissociate molecular nitrogen, other experiments have been developed using plasma discharges, either Direct Current Plasma (DCP) (Bernard et al. 2003; Somogyi et al. 2005), corona discharges (Ramírez et al. 2005), dielectric barrier discharges (Horvath et al. 2010) or radiofrequency plasmas (Imanaka et al. 2004; Szopa et al. 2006), as the energy source. In this case, the chemistry is induced by electronic impact on methane and molecular nitrogen. The energy distribution of the electrons in the plasma is not so different from the energy spectrum of solar photons (Szopa et al. 2006). Moreover, Robertson et al. (2009) showed that the shape of dayside (photon and electron induced chemistry) and nightside (electron chemistry only) INMS ion mass spectra were similar. This observation suggests that the plasma chemistry found in Titan's ionosphere is more or less similar when initiated by photons or by electrons. It also supports the idea that, experimental plasma setups are relevant tools to simulate Titan's upper atmosphere.

The PAMPRE experimental setup used in this study employs a RadioFrequency Capacitively Coupled Plasma (RF CCP) discharge to dissociate N₂. Alcouffe et al. 2010 have given a wider description of the different plasma experimental setups that have been developed to simulate Titan's atmospheric chemistry and have shown the interest of using RF CCP discharges, which are the only experimental setups where tholins can grow in volume (Bouchoule 1999), as in Titan's atmosphere.

Previous studies have been done on the plasma physics and on the properties and chemical composition of tholins on PAMPRE experiment (Carrasco et al. 2009; Hadamcik et al. 2009; Alcouffe et al. 2010; Pernot et al. 2010). Recently, the chemistry of the reactive gas mixture and the carbon gas to solid conversion yield in PAMPRE have also been studied (Sciamma-O'Brien et al. 2010).

Here we present the first study of the gas products in PAMPRE, both on their detection and their relative quantification. This study will help to understand the chemistry in the gas phase, highlighting key organic species responsible for the resulting in tholin formation.

2 Experimental setup and protocol

2.1 The PAMPRE experiment

The PAMPRE experiment goal is to simulate Titan's atmospheric chemistry, and particularly the chemical reactivity leading to the formation of aerosols, by producing laboratory analogues of these aerosols (Szopa et al. 2006).

The PAMPRE experimental setup configuration used for this study is shown in Fig. 1 and a description of the experimental protocol on PAMPRE can be found in Sciamma-O'Brien et al. 2010).

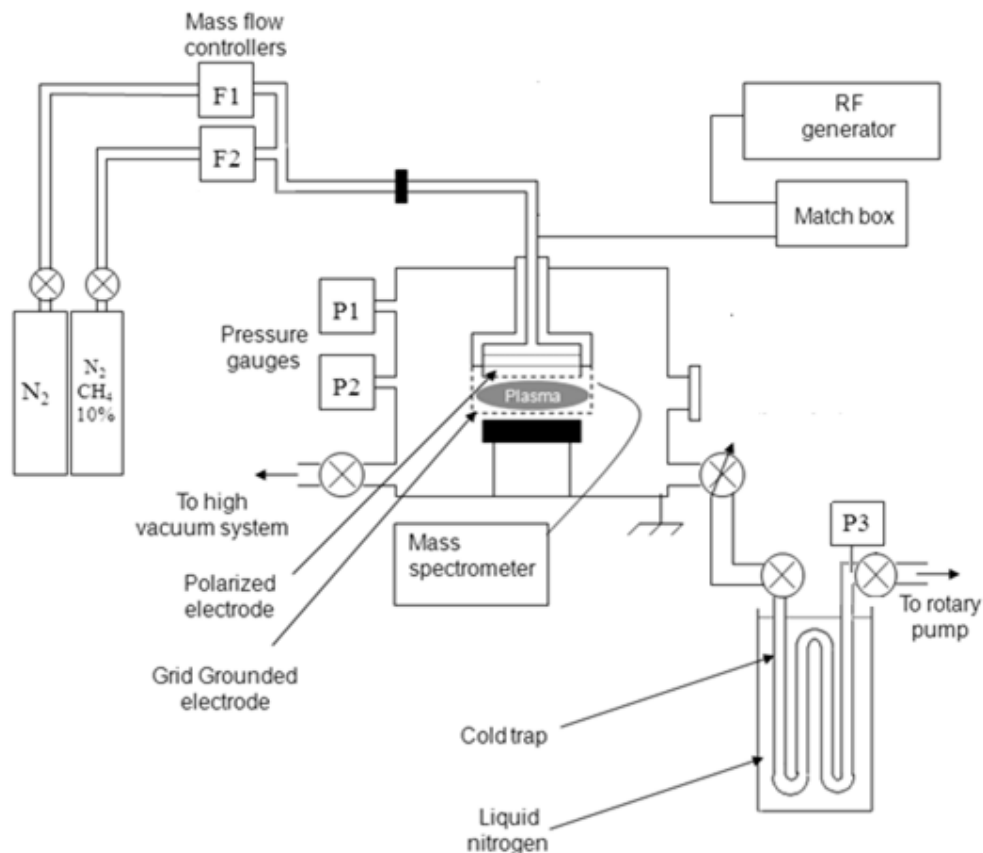

Figure 1

In the study presented here, all experiments were performed with a continuous 55 sccm N_2 - CH_4 gas flow using different methane concentrations. The methane percentages taken into account in the present work are 1%, 4% and 10% CH_4 in N_2 . The 1% and 10% CH_4 concentrations were chosen because they are the extreme values accessible with the PAMPRE setup. The 4% CH_4 concentration was also studied since it corresponds to the maximum tholin production (Sciamma-O'Brien et al. 2010). The pressure in the reactor was approximately 1.7 mbar and the gas temperature was the room temperature.

Using in-situ mass spectrometry, Pintassilgo et al. (1999) have shown that in DC N_2 - CH_4 discharges, CH_4 is strongly dissociated. In a previous work, the CH_4

consumption in the PAMPRE experiment has been monitored using a mass spectrometer (Sciamma-O'Brien et al. 2010). Unfortunately, in-situ mass spectrometry does not allow to measure minor species in the reactor.

On the experimental setup used for the study presented here, as shown in Fig. 1, a cold trap was located at the gas outlet of the reactor. This cold trap is a cylindrical glass coil, with a diameter of 1.3 cm, a length of 1 m and a total volume of 133 cm³, which is immersed in liquid nitrogen. The gas pumped from the reactor flows through this trap where products coming from the reactive gas mixture can condense depending on the pressure and the temperature. Since the trap is cooled by liquid nitrogen, the gas temperature is $T \geq 77\text{K}$. The pumping induces a pressure gradient from the reactor ($P=1.7\text{mbar}$) to the pump such that the pressure in the cold trap is lower than 1.7mbar. This setup allows the trapping of all the species condensable in these temperature and pressure conditions. A Bourdon pressure gauge measures the pressure in the trap in the range from 0 to 1000 mbar with a resolution of ± 10 mbar.

In the study presented here, the trap was heated and then pumped with a turbo pump before each experiment in order to remove water vapor adsorbed on the trap walls. Experiments were 3h long and were repeated at least two times in order to ensure the repeatability of the measurement.

At the end of an experiment, the trap was isolated from the reactor with a gas valve. The pressure inside it while it was still immersed in liquid nitrogen was below the limit of detection of the Bourdon gauge. When the trap was warmed up to room temperature, the light species trapped were going back to their gas phase and a solid residue was formed when the trap returns to room temperature. In the present study,

only the gas phase present in the cold trap was analyzed. The analysis of the solid residue will be the subject of a future work

The absence of condensation of both N_2 and CH_4 in the trap was checked with non reactive experiments (plasma off), where a 55 sccm flux of N_2 - CH_4 90:10 was injected in the reactor in the same pressure conditions. After a 3 hour run the trap was taken out of liquid nitrogen and left at room temperature to warm up. As no pressure increase was observed, neither nitrogen nor methane get trapped.

2.2 Gas phase analysis with Gas Chromatography-Mass Spectrometry

The gas trapped was analyzed by Gas Chromatography coupled to Mass Spectrometry (GC-MS). The cold trap was connected to a GC-MS device through a six port gas valve to perform direct injection of the trapped gas.

The GC-MS device used in this study was a ThermoScientific GC-Trace coupled to a ThermoScientific DSQ II Mass spectrometer operated in a quadrupole detection mode. The column used for the gas separation was a MXT-QPlot (Restek) 30 m long, 0.25 mm internal diameter and 10 μm stationary phase thickness designed to easily separate volatile compounds up to five carbons. For this study, the column temperature was set with a temperature isotherm at 30 °C during 5 minutes, then a gradient of 5 °C/min from 30 °C to 190 °C and a second isotherm at 190 °C for 5 minutes. Helium was used as a carrier gas at a constant 1 mL.min⁻¹ flow rate. The injector used was an Optic 3 thermal desorber working either in split (1/10) or in splitless mode. The gas phase was trapped in split mode at low temperature (-80 °C) in the injector's liner filled with a mixture of Tenax and Carboseive®. This step allowed concentrating the target species. In order to inject them in the GC, the

injector liner was then quickly heated (with a rate of $16^{\circ}\text{C}\cdot\text{min}^{-1}$) at 250°C . It operated in splitless mode. The temperature of the detector was set to 200°C .

Before each injection, a blank experiment was performed under the same analytical conditions without any sample injected. This blank injection allows us to clearly identify potential contaminant species, and discriminate them from chemical species evolving from the sample. No specific contamination was detected in the blank except usual column releases.

3 Results

3.1 Pressure of the gas in the cold trap

When the trap is warmed up, the gas pressure inside the cold trap increases, showing the presence of gas products accumulated during the experiment and condensed in the trap. For the different experiments carried out, this pressure was shown to depend on the methane concentration of the gas mixture injected in the reactor. This indicates that the total amount of condensable species produced changes with the amount of methane introduced in the reactor. The evolution of the total gas pressure measured in the cold trap after warming up to room temperature is given in Figure 2 as a function of the CH_4 concentration. The evolution of the carbon gas to solid conversion yield obtained from a previous study (Sciamma-O'Brien et al. 2010) is also plotted in this figure. This yield is defined as the ratio between the mass of solid carbon incorporated in the tholins and the mass of reactive gaseous carbon coming from the CH_4 consumption in PAMPRE. It reflects the efficiency of the reactive gas mixture to produce solid aerosols, relatively to the carbon element transfer from reactants (CH_4) to products.

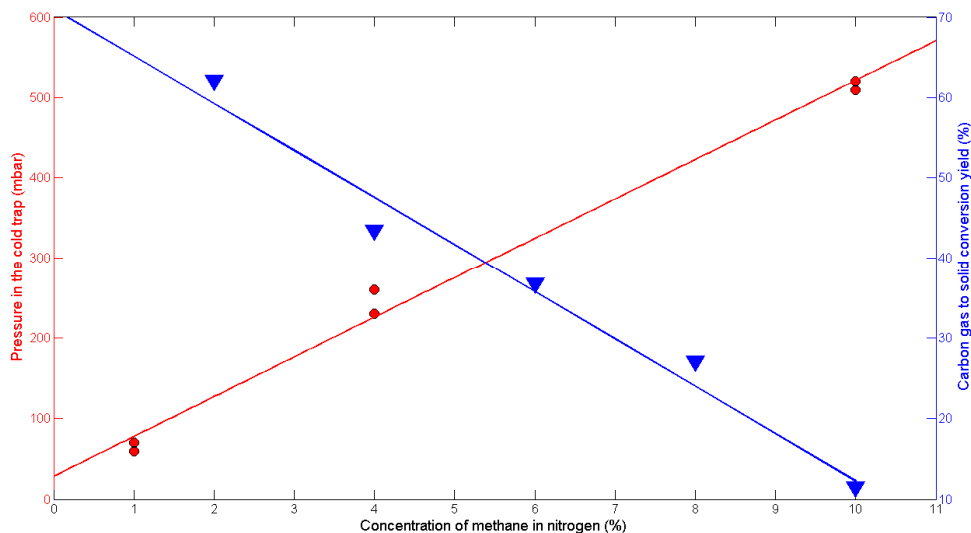

Figure 2

Figure 2 shows that the highest pressure difference measured between two similar experiments is of 14%, ensuring a satisfying reproducibility of the measurements. Moreover, this pressure linearly increases with the CH_4 concentration. The pressure in the cold trap rises from 60 mbar after an experiment with 1% of CH_4 in the gas mixture up to 500 mbar of gas in the cold trap after an experiment with 10% of CH_4 in the gas mixture. On the other hand, the carbon gas to solid conversion yield linearly decreases with the increasing concentration of methane in nitrogen. For 2% of CH_4 in the experiment, the carbon gas to solid conversion yield is 62% while for 10% of CH_4 in the gas mixture the yield plummets to 12% (Sciamma-O'Brien et al. 2010).

The opposite evolution of the two parameters with the CH_4 concentration in the reactive gas mixture is consistent with the product formation trend in the PAMPRE reactor. At low CH_4 concentrations, gaseous products are essentially converted into solid phase (tholins); the amount of gas remaining is thus low. Inversely, for high CH_4

concentrations, the gas products are not consumed much to create tholins, and stay in the gas phase; the total gas pressure in the trap is then higher.

3.2 GC-MS results

3.2.1 Evolution of the gas phase from 1 to 10% of CH₄ in the experiments

Evolution of the gas

The three chromatograms given in Fig. 3 a, b, c correspond to three experiments respectively at 1%, 4% and 10 % of CH₄ in N₂. All the peaks have been identified using their elution order and their mass spectra. The peaks of highest intensity seen in these chromatograms can be attributed to nitriles. The main peak is due to hydrogen cyanide (HCN), the second peak in intensity is acetonitrile (CH₃CN) while the two other predominant peaks are attributed to propanenitrile (CH₃CH₂CN) and propenenitrile (CH₂CHCN).

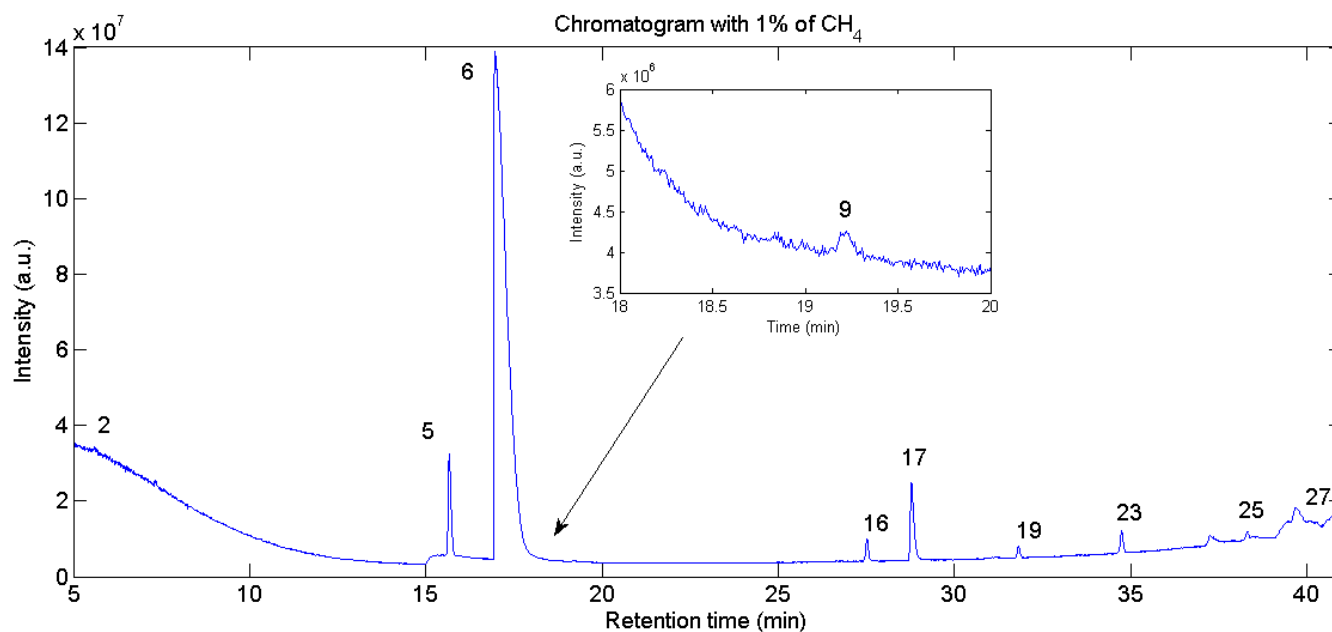
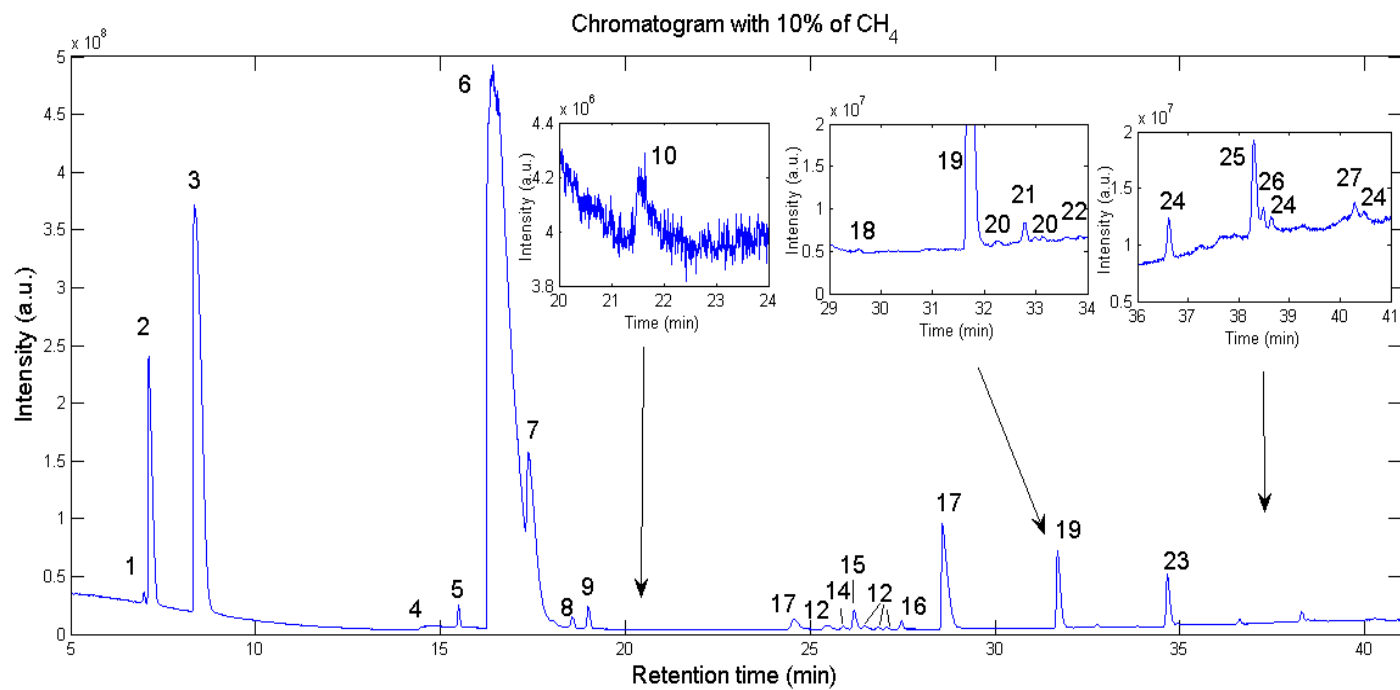
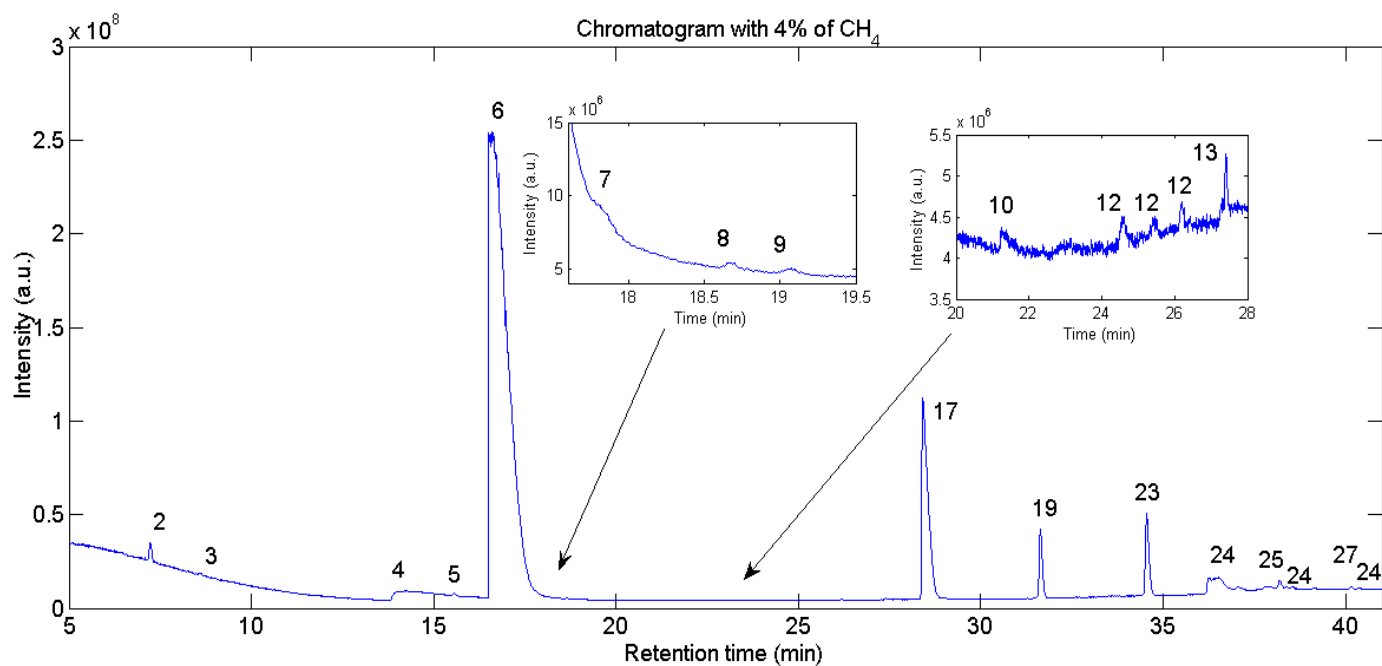

Figure 3 a



From the analysis of all the chromatograms obtained, whatever the methane concentration, more than 30 species have been detected (cf. table 1) among which a

large amount of nitriles, many hydrocarbons, and a few aromatics, mainly heteroaromatic compounds.

Considering that the MS response is similar for all the detected compounds, whatever the methane concentration in the reactor is, nitrile peaks are always the overriding peaks in the chromatograms, meaning that nitriles are the main species in the gas phase.

For samples produced with 1% and 4% of CH₄ in the experiment, the chromatograms look similar, with just a small increase of the existing peaks. However, for the sample produced with 10% of CH₄, new peaks can be observed on the chromatogram. From their retention time and their mass spectra, these peaks can be identified as hydrocarbons. Hydrocarbons containing two carbon atoms (C₂) are eluted at Tr=5.3 minutes (Ethylene), Tr=7.2 minutes (Acetylene) and Tr=8.6 minutes (Ethane). C₃ hydrocarbons are identified at Tr=17.2 minutes (propene), Tr=17.4 minutes (propane) and Tr=18.9 minutes (propyne), while C₄ hydrocarbons are eluted in the range of Tr=25 to 27 minutes. Thanks to pre-concentrated injections performed on a sample coming from an experiment with 10% CH₄ in the reactor, a small signal due to heavier compounds (C₅H₁₂, C₅H₁₀, C₅H₈, C₆H₆) can also be detected for retention time higher than 35 minutes.

3.2.2 Chemical species detected in the gas phase

▶ The list of all the gaseous compounds detected is given in Table 1.

[Table 1]

Comparison to Titan:

The list of compounds detected in the cold trap with GC-MS and presented in Table 1 is consistent with the currently known list of Titan's atmospheric compounds (Vuitton et al. 2007; Waite et al. 2007; Lavvas et al. 2008; Cui et al. 2009; Robertson et al. 2009). In addition, we have been able to detect some heavy nitriles not detected on Titan, such as butanenitrile ($\text{CH}_3\text{-(CH}_2\text{)}_2\text{-CN}$) and pentanenitrile ($\text{CH}_3\text{-(CH}_2\text{)}_3\text{-CN}$). The non detection of these molecules on Titan could be explained by the fact that these molecules are expected to be at very low concentrations, far below the current limit of detection of the instruments onboard Cassini/Huygens. In this case, we suggest some minor species to be present in Titan's atmosphere.

Comparison to other laboratory studies:

It is possible to compare our results with other experimental works containing gas phase analysis. This comparison has been mainly done with experiments closed to PAMPRE experiment, i.e. able to dissociate molecular nitrogen. This criterion limits comparison with plasma experiments (Ramírez et al. 2001; Bernard et al. 2003; Ramírez et al. 2005). We also included a comparison with the work of Tran et al. (2005), a photochemical experiment, where nitrogenous compounds (such as HCN) were introduced to provide nitrogen to the reactive mixture.

As shown in Table 1, most of the species detected in our experiments are also consistent with the compounds detected in other lab experiments with the same light species detected and with a longer list of heavy nitriles (Ramírez et al. 2001; Bernard et al. 2003; Ramírez et al. 2005).

However, a few differences are observed between the experimental setups. There are two possible explanations for these differences. First, for experiments capable of dissociating molecular nitrogen, differences observed probably come from the

detection methods used. The molecules detected are indeed at very low concentrations and could remain unseen if the separation and detection methods were not optimized to detect them. For example, Tran et al. (2005) detected more heavy compounds than in our study due to their GC column whose stationary phase is optimized for light aromatics detection (Restek RTX-502.2 capillary column). Second, the lack of nitrogenous compounds in some photochemical irradiation experiments (Bar-Nun et al. 2008) can be explained by the fact that molecular nitrogen is not dissociated. Indeed, the bond energy for N_2 is 9.7eV which means that this molecule needs a radiation with a wavelength lower than 128nm to be photo-dissociated and to release a nitrogen atom that could be involved in further reactions. Unfortunately, since silica cuts off radiation around 200 nm, if an experimental setup uses silica windows, molecular nitrogen will not be dissociated nor will it be used to form nitrogen-bearing species.

Finally, it is interesting to note that ammonia was detected in our experiments in much lower concentrations than expected (Bernard et al. 2003). One possible explanation for this lack of NH_3 is the use of stainless steel for transfer and injection in the GC-MS, since ammonia is known to adsorb onto it. The ammonia concentration detected in the GC-MS chromatograms might therefore not be representative of the ammonia present in the cold trap. A solution for ammonia detection might be to perform a Siltek® treatment of the stainless steel parts.

Oxygen containing compounds:

A few oxygen-bearing compounds have also been detected (cf. Table 1) in our experiments: three compounds with low peaks areas (less than 0.1% of the HCN peak area). Those can be explained by the presence of remaining micro-leaks due to

the use of a low pressure experiment. They have been measured to be lower than 10^{-3} sccm, four orders of magnitude lower than the 55 sccm injected gas flow rate. The oxygen contamination can thus be considered as negligible in this work.

Aromatic species:

As shown in Table 1, we have also detected aromatic compounds in the cold trap. These aromatic compounds are however less numerous than reported in other laboratory experiments (Ramírez et al. 2001). This could be due to the GC column used in the present work, which was optimized for the detection of light molecules containing approximately up to 6 carbon or nitrogen atoms.

Moreover, the detected aromatic compounds are mainly heteroaromatics, containing at least one nitrogen atom. The main aromatic species detected is tetrazolo[1,5-b]pyridazine which seems to be the bountiful aromatic compound in the gas mixture. The topological formulas of this compound and its experimental mass spectrum compared to theoretical mass spectra from NIST database are shown in Fig. 4.

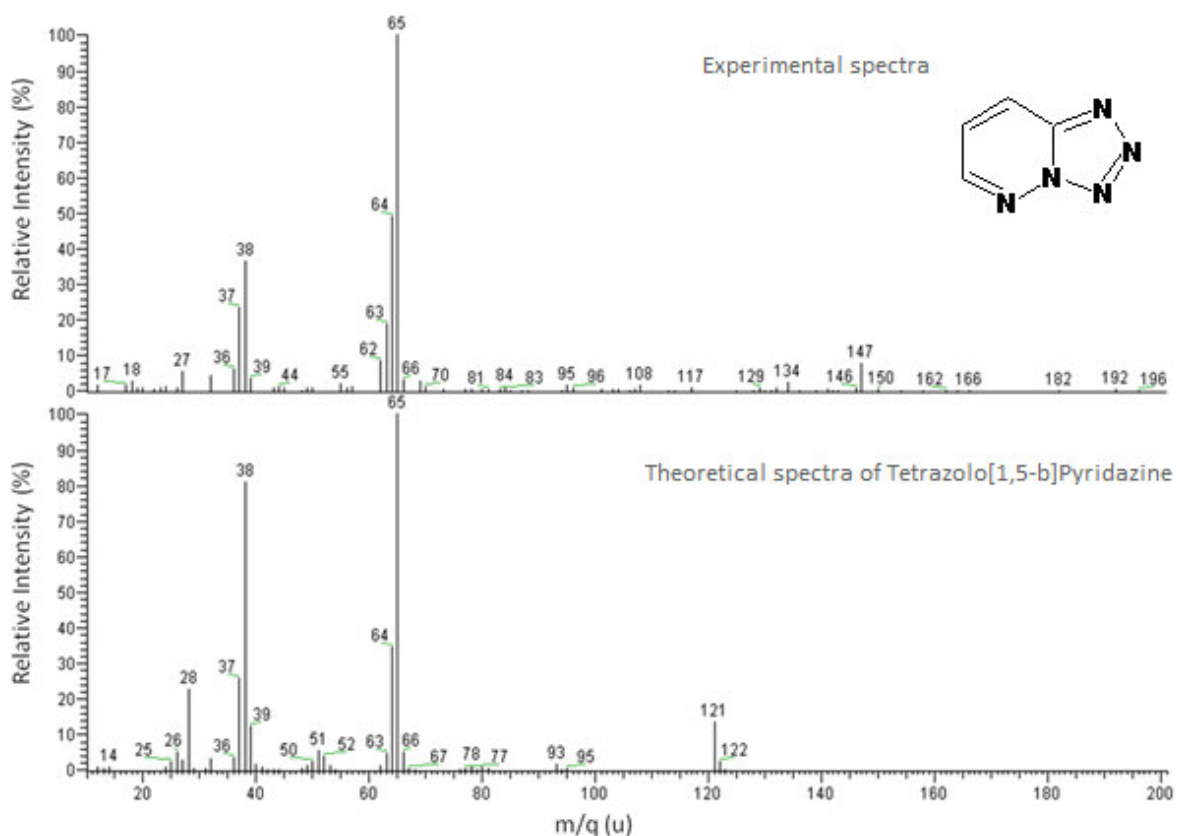

Figure 4

The formation of Tetrazolo[1,5-b]pyridazine is not well explained yet. A possible hypothesis could be the addition of Propenenitrile (C_3H_3N), one of the most abundant molecules detected in the cold trap, with tetrazole (CH_2N_4). Tetrazole is basically formed by a reaction between hydrogen cyanide (HCN) and N_3^+ but its presence still has to be explained in our case, even if N_3^+ is known to be present in nitrogen plasmas (de Petris et al. 2006).

4 Discussion

4.1 The Predominance of nitriles

In order to characterize the evolution of the nature of the chemical species detected in the sample as a function of the injected methane concentration, a qualitative ratio

ρ has been defined as $\rho = n_N/n_{CH}$. Where n_N is the number of N-bearing compounds and n_{CH} is the number of hydrocarbons. Even if this ratio characterizes only the number of detected species and does not take into account the relative area of the peaks in the chromatograms, ρ provides a good first-level indicator of the nitrile to hydrocarbon ratio which allows the relative comparison of the results obtained with the three methane concentration chromatograms. The evolution of ρ with the CH_4 concentration is given in Table 2.

[Table 2]

As we can see, the value of this ratio shows significant differences between low methane concentrations (1 and 4%) and high methane concentrations (10%). At low CH_4 concentrations the number of nitrile compounds is at least 3 times higher than the number of hydrocarbons, while at high CH_4 concentrations there are more hydrocarbons than nitriles. This suggests a change in the gas chemistry for the 10% of methane condition, compatible with the gas to solid conversion efficiency studied in Sciamma-O'Brien et al (2010).

4.2 Discussion on the possible predominance of N-Bearing compounds in Titan's aerosols

Even for experiments with ρ values in favor of hydrocarbons (experiments with 10% of methane in the initial mixture), if considering the area of peaks, nitriles are by far the major chemical products in the gas phase. Therefore they are suspected to largely contribute to the chemistry leading to the formation of aerosols in our experiment.

For a long time, Titan's aerosols were considered to be formed by the aggregation of poly-aromatic hydrocarbons (PAH) (Waite et al. 2007). However, for the last few

years, several publications have considered that nitrogenous compounds contribute significantly to the aerosol formation process.

This hypothesis is based on several clues. First, the observational data from the Cassini-Huygens mission have shown that there is a large amount of nitrogenous molecules such as nitriles or imines in Titan's atmosphere (Vuitton et al. 2007; Waite et al. 2007; Vuitton et al. 2009; Yelle et al. 2010). Second, atmospheric chemistry models have also inferred that quite a large amount of nitriles should be present in Titan's atmosphere, even more than hydrocarbons for a given number of atoms (Lebonnois et al. 2001; Hebrard 2006; Lavvas et al. 2008). On the other hand, some observational data analyses have implied that the concentration of nitriles is slightly smaller than the hydrocarbon concentration (Vinatier et al. 2010). Models have also started to formulate hypotheses on the presence of a chemical pathway producing poly aromatic nitrogenous hetero-cycles (PANH), instead of a commonly admitted full PAH pathway in Titan's atmospheric chemistry (Vuitton et al. 2007). This tends to be confirmed by the detection of nitrogen-bearing aromatics in analogues of Titan's aerosols produced in laboratory experiments such as the PAMPRE tholins (Pernot et al. 2010).

4.3 Nitrile reactivity

The laboratory experiments which are capable of dissociating N_2 are known to generate a complex chemistry producing both hydrocarbons and nitrogenous compounds (Bernard et al. 2003; Imanaka et al. 2004; Tran et al. 2005). Moreover, structural and chemical analyses performed on tholins produced with different laboratory experiments have confirmed that they contain large amounts of nitrogen

(Imanaka et al. 2004; Carrasco et al. 2009; Pernot et al. 2010; Sciamma-O'Brien et al. 2010), in agreement with the ACP-Huygens results (Israel et al. 2005).

Despite the detection and the apparent importance of nitrogenous compounds in the formation of tholins (Khare et al. 2002; Hudson and Moore 2004; Imanaka et al. 2004), the gas chemistry and reactive schemes of nitriles are still largely unknown and largely underestimated in atmospheric models of Titan (Hebrard 2006; Lavvas et al. 2008). The only part of the nitrile chemistry that is taken into account in some models, deals with reactions between CN radicals or the lightest nitriles and hydrocarbons (Hebrard 2006; Cui et al. 2009).

Even if the agreement between models and observations is not perfect (Hébrard et al. 2007), HCN production is the most understood pathway (Yung 1987) leading to nitriles in Titan's atmosphere. Several mechanisms have been proposed to produce nitrogen-bearing tholins by polymerization of HCN, CN or CH₃CN (Wilson and Atreya 2003; Krasnopolsky 2009), either on a hydrocarbon, to produce a nitrile, or on another nitrile, to produce a dinitrile (Lavvas et al. 2008).

However, it is important to note that even the production of a simple molecule like acetonitrile is still an open question and deserves a particular attention in order to better explain the large densities observed in different regions of Titan's atmosphere. All the recent post-Cassini models use the rate constant from Sato et al. 1999) to describe the kinetics of the reaction between N(²D) and C₂H₄; but the branching ratios of the reactions have not been quantified yet and can lead to several scenarios implemented in photochemical models. In all cases, this reaction is treated as either the only pathway or at least one of the most important enabling the production of acetonitrile. Wilson and Atreya (2003), Hebrard (2006) and Lavvas et al. (2008)

implemented a 100% acetonitrile production pathway, whereas Krasnopolsky (2009) used only a 20% acetonitrile pathway (and 80% for $\text{NH}+\text{C}_2\text{H}_3$). However, the RRKM calculations of Takayanagi et al. (1998) and the molecular crossed-beam experiments of Balucani et al. (2000) predict 2H-azirine and ketene-imine as the major products at low temperature, with a very minor direct production of acetonitrile. It would be useful to do experiments at the temperature range of Titan's atmosphere to try and confirm/quantify if the isomerisation of these two major products towards acetonitrile could explain an efficient production of acetonitrile from the reaction $\text{N}(^2\text{D})+\text{C}_2\text{H}_4$ as suggested by Balucani et al. (2000).

Reactions with CN radical have been widely studied in the last twenty years. Butterfield et al. 1993 have shown that the reactions of CN with allene, butadiene, propylene and propenenitrile can take place in the gas phase. Carty et al. 2001 have confirmed the reaction of CN with allene and they have also added the reaction of CN with methylacetylene. Yang et al. 1992 have studied the reactivity of CN with alkanes (C_2H_6 , C_3H_8 , C_4H_{10} , C_5H_{12} et C_8H_{18}), while Seki et al. 1996 have studied its reactivity with acetylene and ethanedinitrile. A study of the addition of CN to CH_4 , C_2H_6 , C_2H_4 , C_2H_2 and C_3H_6 can be found in Sims et al. 1993 and the reaction $\text{CN}+\text{CH}_3\text{CN}$ is given in Zabarnick 1989. In addition, Monks et al. 1993 have considered some of the previous reactions in an oxygenated medium, and Hoobler and Leone 1997 have studied the reactions of C_2H with HCN or CH_3CN .

However, due to the lack of knowledge on the nitrile's reactivity, few studies propose other pathways than $\text{CN} + \text{hydrocarbon}$ to form heavy nitriles. And yet Recent CIRS observations compared the nitrile lifetimes at 300 km of altitude predicted by the photochemical model of Wilson and Atreya (2004) with the observed nitrile

enrichment in the North polar latitudes of Titan. They have shown an unsuspected specific reactivity of nitriles on Titan (Teanby et al. 2010). Therefore, it is of high priority to study the underestimated reactivity of nitriles, which are known to be very efficient polymerization products in plasma physics (Yu et al. 1988; Lefohn et al. 1998; Bhat and Upadhyay 2003; Jampala et al. 2008).

Nitriles are rarely considered as reactive molecules. However, knowing how labile the hydrogen in alpha position of a nitrile molecule is (Carey and Sundberg 2007), it is reasonable to consider that they can be involved in the chemical pathways leading to the production of aerosols in Titan's atmosphere. The energy coming from the solar radiation and/or the Saturn magnetosphere electron bombardment or a chemical reaction with a sufficiently reactive radical could free the alpha hydrogen of a nitrile molecule, as shown in the following scheme. A much more reactive radical would result from these processes, and could play a role in Titan's complex atmospheric chemistry.

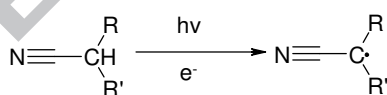

In addition, nitriles could also provide reactive species to form pre-biotic molecules at the surface of Titan or cometary dusts. Particularly, if tholins deposited on Titan's surface could get in contact with liquid water, a hydrolysis reaction would occur, leading to the formation of amino compounds (Khare et al. 1986; Hudson and Moore 2004; Neish et al. 2010; Ramírez et al. 2010). This contact between tholins and liquid water would be possible since frozen water is abundant at Titan's surface (Tobie et al. 2005). One could expect ice melting from impacts (or cryovolcanism) which may

lead to episodic presence of liquid water with a lifetime from 10^2 to 10^4 years (O'Brien et al. 2005).

4.4 Nitrile quantification

4.4.1 Criteria of relative quantification

In the study presented here, a direct quantification of compounds was not possible due to the fact that absolute intensities differed from a chromatogram to another (even for two experiments with the same methane concentration). A quantitative analysis in gas chromatography requires the addition of an internal or external standard in the solute, which was not possible with the configuration of our experimental system. However, by considering each experiment individually, a relative quantification of the nitrile concentrations was achieved.

In order to look for possible growth mechanisms, the area of chromatographic peaks corresponding to nitrile compounds are measured. Only mono-nitriles with a saturated alkyl chain were studied. Dinitriles are excluded because of the two step process they require to be produced. Nitriles with unsaturated radicals are not taken into account either because their formation requires the addition of a CN radical on a pre-existing unsaturated molecule. For example, the formation of propionitrile (HC_3N), detected both in Titan's atmosphere and in our experiment, is formed by the addition of CN on acetylene (Seki et al. 1996). In this work we look for new patterns different from the usual CN + hydrocarbons pathway.

Five nitriles correspond to these criteria in our data: hydrogen cyanide (H-CN), acetonitrile ($\text{CH}_3\text{-CN}$), propanenitrile ($\text{CH}_3\text{-CH}_2\text{-CN}$), butanenitrile ($\text{CH}_3\text{-CH}_2\text{-CH}_2\text{-CN}$) and isobutyronitrile ($(\text{CH}_3)_2\text{CHCN}$).

The chromatographic peak areas of these species are plotted as a function of the number of carbon atoms present in the molecule. As both butanenitrile and isobutyronitrile contain four carbon atoms, their respective areas are added.

4.4.2 Calibration of the peak areas

As the samples were analyzed through a gas chromatograph coupled with a mass spectrometer, the data collected correspond to peak areas and not directly to the concentration of compounds. To infer the relative concentrations of the nitriles from their area we had to use the ionization cross section of nitriles.

The mass spectrometer ionizes the molecules by electron impact accelerated at 70eV. Unfortunately, at this energy, the nitrile ionization cross sections are still unknown. It is however possible to estimate these cross sections using the theoretical calculations developed by Fitch and Sauter (1983).

Using their semi-empirical formula the ionization cross section, Q ($\times 10^{-16}$ cm²), of a molecule can be calculated based on its atomic composition and on the available experimental ionization cross sections. This formula is given in Equation (1):

$$Q = 0.082 + \sum_{i=1}^9 \alpha_i n_i \quad (1)$$

where α_i is a coefficient which depends on the type of atom and n_i is the number of atoms for each element. The formula is valid for molecules containing H, C, N, O, F, Cl, Br and I. Coefficients for hydrogen, carbon and nitrogen are respectively 0.73×10^{-16} cm², 1.43×10^{-16} cm² and 1.20×10^{-16} cm².

Using Equation (1) we have calculated the ionization cross section for the five nitriles chosen for the study presented here. They are given in Table 3.

[Table 3]

The electron impact ionization cross sections have an influence on the area of the chromatographic peaks. As a first approximation we consider that the area A of a species s , is directly dependent on the species concentration and on its cross section: $A_s \propto C_s Q_s$.

As we consider the relative concentrations, the peak area of a hydrocarbon i has to be multiplied by the factor corresponding to the ratio $Q_{\text{HCN}}/Q_{\text{RCN}}$. For example, as the cross section of butanenitrile is approximately four times higher than the one of hydrogen cyanide, the area of the butanenitrile peak has to be divided by four to be compared to the area of the hydrogen cyanide peak.

4.4.3 The nitrile concentration decrease law

After applying this cross section correction to the areas of the chosen nitrile peaks, the relative nitrile concentrations (HCN area normalized) as a function of the number of carbon atoms in the molecules were plotted.

Figure 5 shows the relative concentration of the five chosen nitriles seen in Table 3 after correcting their relative concentrations using their respective ionization cross sections.

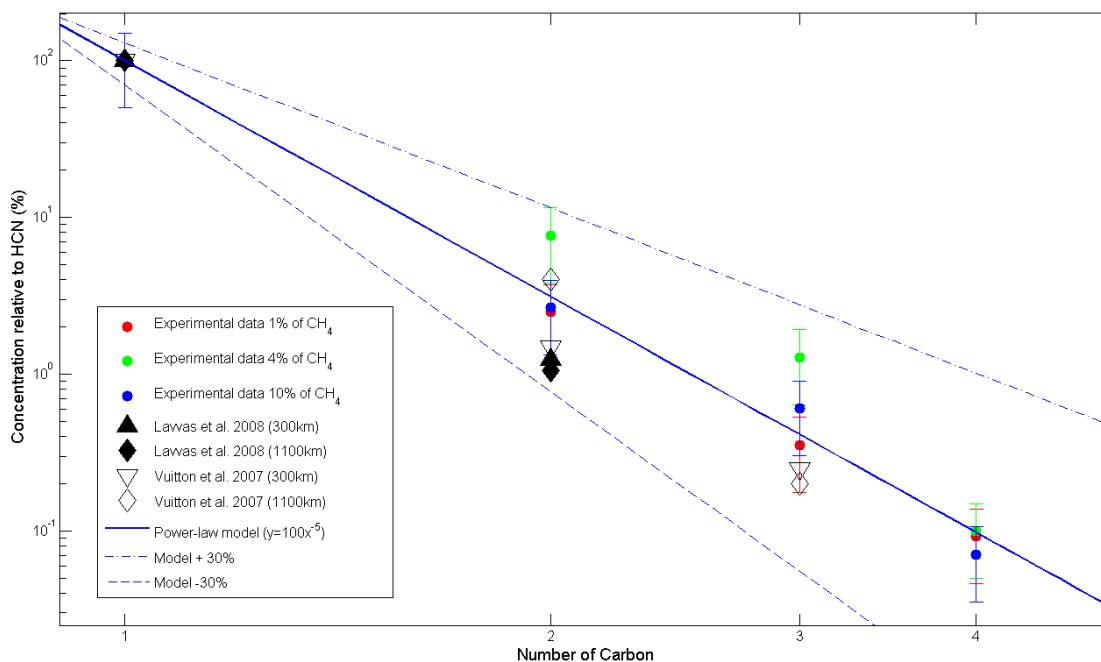

Figure 5

The first trend observed on Fig. 5 is the decrease of nitrile concentrations when the number of carbon inside the molecules increases. The shape of this decrease can be modeled with a mathematical power law. The empirical model linked to our data, plotted in Fig. 5, is in good agreement with the experimental data within error bars. Those are estimated at up to 50%, including uncertainties on ionization cross-sections, GC-MS peak areas, reproducibility of the injection protocol in the GC-MS, the production process and trapping in the PAMPRE experiment.

This power-law decrease shows interdependence between the concentrations of the different nitriles, i.e. the concentration of a $C_xH_{2x-1}CN$ ($x \in \mathbb{N}^*$) nitrile is first order dependent on the concentration of the $C_{x-1}H_{2x-3}CN$ nitrile.

One can see in Fig. 5 that there are no significant differences between the data sets, whatever the percentage of methane in the experiment. As a consequence a general

power law can be extracted from all the experimental data. Equation (2) gives this power-law decrease when HCN is normalized to 100%:

$$[C_xH_{2x-1}N] = 100x^{-\beta} \quad (2)$$

x is the number of carbon atoms in a nitrile with saturated carbonaceous radical; ($x \in \mathbb{N}^*$). Equation (2) assumes that HCN is normalized to 100%. Using this power law model, it is then possible to estimate the concentration of heavy mono-nitriles with carbonaceous saturated radicals if the concentration of light nitriles is known. As shown in Fig.5, the experimental data and the associated power-law empirical model are also totally consistent with Titan's observational data from INMS (Vuitton et al. 2007) as well as with the results from photochemical models (Lavvas et al. 2008). Equation (2) can therefore determine the expected concentration of heavy nitriles, not yet detected, in Titan's atmosphere.

Dobrijevic and Dutour (2006) have proposed a power-law equation to model the concentration decrease of molecules whose growth comes from the regular addition of a unique monomer. In the same way, we can consider that the power-law model we used is also linked to a polymerization scheme of the molecules.

In that case, to go from a $C_{x-1}H_{2x-1}CN$ nitrile to a $C_xH_{2x+1}CN$ nitrile, the required monomer would have to bring one carbon atom and two hydrogen atoms within a linear formula. The intuitive candidate is the methyl fragment, CH_3 , which could react with a pre-existing nitrile that lost a hydrogen atom.

Overall, our results highlight that nitriles are reactive compounds, in agreement with the recent CIRS observation by Teanby et al. (2010) and seem to be less inert than

implemented in models, where they are mostly considered as chemical reaction sink (Lebonnois et al. 2001; Wilson and Atreya 2003; Hebrard 2006; Lavvas et al. 2008).

Conclusion

Here are presented the first study of the gas phase products in the PAMPRE experiment. We have successfully used a cold trap and GC-MS analysis to deduce the gas composition in a N_2 - CH_4 reactive gas mixture simulating Titan's atmosphere.

A large amount of nitriles in the trapped gas mixture has been found, as high as four times the amount of hydrocarbons for a gas mixture with low methane concentration. The main product detected is hydrogen cyanide which has also been detected in large amounts in Titan's atmosphere (Teanby et al. 2007; Vinatier et al. 2010). We have also detected heavier nitriles such as ethanenitrile, propanenitrile and propenenitrile. These heavier nitriles, also detected in Titan's atmosphere, are assumed to be the major compounds in our reactive medium. We have also observed an increase in the ratio between nitriles and hydrocarbons with the decrease of methane concentration in the reactor.

The results of the PAMPRE experiment are consistent with Titan's atmospheric composition, this tends to demonstrate that laboratory experiments, at least those allowing nitrogen dissociation, can be used complementarily to observational data in order to predict both the presence and possible concentrations of compounds which are not yet detected.

On a larger scale, we have detected more than thirty compounds, which, for some of them, had never been detected in experimental simulations before but were expected since they had been observed in Titan atmosphere. Heteroaromatic compounds

have also been detected, supporting the hypothesis of PANH pathways for the growth of Titan's aerosols.

The results presented here show the possible importance of nitrogenous compounds in Titan's atmospheric chemistry. With this study we bring more clues to the previously proposed chemical route for aerosol formation in Titan's atmosphere which would predominantly use nitrogen-bearing compounds instead of PAHs (Vuitton et al. 2007; Pernot et al. 2010).

Unfortunately, the nitrile gas chemistry is still mostly unknown, and nitriles are often ignored in Titan atmospheric models even though we know, both from observations and from computational models, that they could be present in large amounts on Titan (Teanby et al. 2007; Lavvas et al. 2008; Vuitton et al. 2009; Teanby et al. 2010; Vinatier et al. 2010).

In addition, in the study presented here, we have been able to relatively quantify some of the unsaturated mono-nitriles present in the gas phase. Using this relative quantification we have proposed a power-law model for the concentration of radically saturated mono-nitriles, which is (with HCN normalized to 100%)

$[C_xH_{2x-1}N] = 100x^{-5}$ where x is the number of carbon atoms in the molecule. With

this law, it is possible to estimate the concentration of heavy nitriles due to chemical production (no transport) knowing the concentration of the lighter nitriles.

It will be important in the future to go further and study the possible role of nitriles in Titan's atmospheric chemistry. Indeed, our study suggests that these compounds could have a key role in the formation of organic aerosols in the high atmosphere of Titan, and more generally in the organic chemistry which takes place on Titan. These molecules including nitrogen are interesting in exobiology as well since they are known for their reactivity and as precursor of amino acids.

Acknowledgments

This work was financially supported by CNRS (PNP, ANR-09-JCJC-0038 contract) and by the PRES UniverSud. E. S-O wishes to thank the CNES for her post-doc position. All the PAMPRE team gratefully thanks Mr. V. Guerrini for the design and the manufacture of the cold trap.

References

- Alcouffe, G., M. Cavarroc, G. Cernogora, F. Ouni, A. Jolly, L. Boufendi and C. Szopa (2010), *Capacitively coupled plasma used to simulate Titan's atmospheric chemistry*. Plasma Sources Sci. Technol. 19(1): 015008.
- Balucani, N., L. Cartechini, M. Alagia, P. Casavecchia and G. G. Volpi (2000), *Observation of Nitrogen-Bearing Organic Molecules from Reactions of Nitrogen Atoms with Hydrocarbons: A Crossed Beam Study of N(2D) + Ethylene*. J. Phys. Chem. A 104(24): 5655-5659.
- Bar-Nun, A., V. Dimitrov and M. Tomasko (2008), *Titan's aerosols: Comparison between our model and DISR findings*. Planet. Space Sci.56(5): 708-714.
- Barnes, J. W., et al. (2009), *VIMS spectral mapping observations of Titan during the Cassini prime mission*. Planet. Space Sci.57(14-15): 1950-1962.
- Bernard, J.-M., P. Coll, A. Coustenis and F. Raulin (2003), *Experimental simulation of Titan's atmosphere: Detection of ammonia and ethylene oxide*. Planet. Space Sci. 51: 1003-1011.
- Bhat, N. V. and D. J. Upadhyay (2003), *Adhesion Aspects of Plasma Polymerized Acetonitrile and Acrylonitrile on Polypropylene Surface*. Plas. Pol. 8(2): 99-118.

Bouchoule, A. (1999), *Dusty Plasmas: Physics, Chemistry, and Technological Impact in Plasma Processing*, Ed. Wiley, Ed., 418p.

Butterfield, M. T., T. Yu and M. C. Lin (1993), *Kinetics of CN reactions with allene, butadiene, propylene and acrylonitrile*. Chem. Phys. 169: 129-134.

Carey, F. and R. J. Sundberg (2007), *Advanced Organic Chemistry*, Ed. Springer, 5th Ed., 1322p.

Carrasco, N., C. Alcaraz, O. Dutuit, S. Plessis, R. Thissen, V. Vuitton, R. Yelle and P. Pernot (2008), *Sensitivity of a Titan ionospheric model to the ion-molecule reaction parameters*. Planet. Space Sci. 56(12): 1644-1657.

Carrasco, N., et al. (2009), *Characterization of Titan's Tholins: Solubility, Morphology and Molecular Structure Revisited*. J. Phys. Chem. A 113(42):11195-203.

Carty, D., V. L. Page, I. R. Sims and I. W. M. Smith (2001), *Low temperature rate coefficients for the reactions of CN and C₂H radicals with allene and methyl acetylene*. Chem. Phys. Lett. 344: 310-316.

Clarke, D. W., J. C. Joseph and J. P. Ferris (2000), *The Design and Use of a Photochemical Flow Reactor: A Laboratory Study of the Atmospheric Chemistry of Cyanoacetylene on Titan*. Icarus 147(1): 282-291.

Cui, J., et al. (2009), *Analysis of Titan's neutral upper atmosphere from Cassini Ion Neutral Mass Spectrometer measurements*. Icarus 200: 581-615.

de Petris, G., A. Cartoni, G. Angelini, O. Ursini, A. Bottoni and M. Calvaresi (2006), *The N₃⁺ Reactivity in Ionized Gases Containing Sulfur, Nitrogen, and Carbon Oxides*. ChemPhysChem 7(10): 2105-2114.

Dobrijevic, M. and I. Dutour (2006), *A random graphs model for the study of chemical complexity in planetary atmospheres*. Planet. Space Sci. 54: 287-295.

Fitch, W. L. and A. D. Sauter (1983), *Calculation of relative electron impact total ionization cross sections for organic molecules*. Anal. Chem. 55(6): 832-835.

Hadamcik, E., J.-B. Renard, G. Alcouffe, A. C. Levasseur-Regourd and C. Szopa (2009), *Laboratory light-scattering measurements with Titan's aerosols analogues produced by a dusty plasma*. Planet. Space Sci. 57(13): 1631-1641.

Hartle, R. E., et al. (2006), *Initial interpretation of Titan plasma interaction as observed by the Cassini plasma spectrometer: Comparisons with Voyager 1*. Planet. Space Sci. 54(12): 1211-1224.

Hébrard, E., M. Dobrijevic, Y. Bénilan and F. Raulin (2006). *Photochemical kinetics uncertainties in modeling Titan's atmosphere: a review*. J. Photochem. Photobiol. C 7 (4), 211-230.

- Hébrard, E., M. Dobrijevic, Y. Bénilan and F. Raulin (2007). *Photochemical kinetics uncertainties in modeling Titan's atmosphere: first consequences*. Planet. Space Sci. 55: 1470-1489.
- Hoobler, R. J. and S. R. Leone (1997), *Rate Coefficients for reactions of ethynyl radical (C₂H) with HCN and CH₃CN: Implications for the formation of complex nitriles on Titan*. J. Geophys. Res. 102(E12): 28717-28723.
- Horvath, G., N. Mason, L. Polachova, M. Zahoran, L. Moravsky and S. Matejcek (2010), *Packed Bed DBD Discharge Experiments in Admixtures of N₂ and CH₄*. Plasma Chem. Plasma Process. 30(5): 565-577.
- Hudson, R. L. and M. H. Moore (2004), *Reactions of nitriles in ices relevant to Titan, comets, and the interstellar medium: formation of cyanate ion, ketenimines and isonitriles*. Icarus 172: 466-478.
- Imanaka, H., B. N. Khare, J. E. Elsila, E. L. O. Bakes, C. P. McKay, D. P. Cruikshank, S. Sugita, T. Matsui and R. N. Zare (2004), *Laboratory experiments of Titan tholin formed in cold plasma at various pressures: implications for nitrogen-containing polycyclic aromatic compounds in Titan haze*. Icarus 168: 344-366.
- Israel, G., et al. (2005), *Complex organic matter in Titan's atmospheric aerosols from in situ pyrolysis and analysis*. Nature 438(7069): 796-799.

Jampala, S. N., M. Sarmadi, S. Manolache and F. S. Denes (2008), *Surface functionalization by RF plasma deposition of ethylene diamine, acrylonitrile, and acetonitrile*. J. Appl. Polym. Sci. 107(3): 1686-1695.

Khare, B. N., E. L. O. Bakes, H. Imanaka, C. P. McKay, D. P. Cruikshank and E. T. Arakawa (2002), *Analysis of the Time-Dependent Chemical Evolution of Titan Haze Tholin*. Icarus 160: 172-182.

Khare, B. N., C. Sagan, H. Ogino, B. Nagy, C. Er, K. H. Schram and E. T. Arakawa (1986), *Amino acids derived from Titan Tholins*. Icarus 68(1): 176-184.

Krasnopolsky, V. A. (2009), *A photochemical model of Titan's atmosphere and ionosphere*. Icarus 201(1): 226-256.

Kuiper (1944), *Titan: a Satellite with an Atmosphere*. Astrophys. J. 100(11): 378.

Lavvas, P. P., A. Coustenis and I. M. Vardavas (2008), *Coupling photochemistry with haze formation in Titan's atmosphere, Part II: Results and validation with Cassini/Huygens data*. Planet. Space Sci. 56(1): 67-99.

Lebonnois, S., D. Toublanc, F. Hourdin and P. Rannou (2001), *Seasonal Variations of Titan's Atmospheric Composition*. Icarus 152(2): 384-406.

- Lefohn, A. E., N. M. Mackie and E. R. Fisher (1998), *Comparison of Films Deposited from Pulsed and Continuous Wave Acetonitrile and Acrylonitrile Plasmas*. *Plas. Pol.* 3(4): 197-209.
- Monks, P. S., P. N. Romani, F. L. Nesbitt, M. Scanlon and L. J. Stief (1993), *The kinetics of the formation of Nitrile compounds in the atmospheres of Titan and Neptune*. *J. Geophys. Res.* 98(E9): 17115-17122.
- Neish, C. D., A. Somogyi and M. A. Smith (2010), *Titan's Primordial Soup: Formation of Amino Acids via Low-Temperature Hydrolysis of Tholins*. *AstroBio.* 10(3): 337-347.
- O'Brien, D. P., R. D. Lorenz and J.I. Lunine (2005), *Numerical calculations of the longevity of impact oases on Titan*. *Icarus* 173(1): 243-253.
- Pernot, P., N. Carrasco, R. Thissen and I. Schmitz-Afonso (2010), *Tholinomics-chemical analysis of nitrogen rich Polymers*. *Anal. Chem.* 82(4): 1371-1380.
- Pintassilgo, C. D., J. Loureiro, G. Cernogora and M. Touzeau (1999), *Methane decomposition and active nitrogen in a N₂-CH₄ glow discharge at low pressures*. *Plasma Sources Sci. Technol.* 8(3): 463.
- Ramírez, S. I., P. Coll, A. Buch, C. Brassé, O. Poch and F. Raulin (2010), *The fate of aerosols on the surface of Titan*. *Faraday Discuss.* 147(In Press).

Ramírez, S. I., R. Navarro-González, P. Coll and F. Raulin (2001), *Possible contribution of different energy sources to the production of organics in Titan's atmosphere*. *Adv. Space Res.* 27(2): 261-270.

Ramírez, S. I., R. Navarro-González, P. Coll and F. Raulin (2005), *Organic chemistry induced by corona discharges in Titan's troposphere: Laboratory simulations*. *Adv. Space Res.* 36(2): 274-280.

Robertson, I. P., et al. (2009), *Structure of Titan's ionosphere: Model comparisons with Cassini data*. *Planet. Space Sci.* 57: 1834-1846.

Sato, K., K. Misawa, Y. Kobayashi, M. Matsui, S. Tsunashima, Y. Kurosaki and T. Takayanagi (1999), *Measurements of Thermal Rate Constants for the Reactions of N(2D,2P) with C2H4 and C2D4 between 225 and 292 K*. *J. Phys. Chem. A*103(43): 8650-8656.

Sciamma-O'Brien, E., N. Carrasco, C. Szopa, A. Buch and G. Cernogora (2010), *Titan's atmosphere: an optimal gas mixture for aerosol production?* *Icarus* 209(2): 704-714.

Seki, K., M. Yagi, M. He, J. B. Halpern and H. Okabe (1996), *Reaction rates of the CN radical with diacetylene and dicyanoacetylene*. *Chem. Phys. Lett.* 258: 657-662.

Sims, I. R., J. L. Queffelec, D. Travers, B. R. Rowe, L. B. Herbert, J. Karthäuser and I. W. M. Smith (1993), *Rate constants for the reactions of CN with hydrocarbons at low and ultra-low temperatures*. Chem. Phys. Lett. 211(4-5).

Sittler Jr, E. C., A. Ali, J. F. Cooper, R. E. Hartle, R. E. Johnson, A. J. Coates and D. T. Young (2009), *Heavy ion formation in Titan's ionosphere: Magnetospheric introduction of free oxygen and a source of Titan's aerosols?* Planet. Space Sci. 57(13): 1547-1557.

Somogyi, A., C.-H. Oh, M. A. Smith and J. I. Lunine (2005), *Organic Environments on Saturn's Moon, Titan: Simulating Chemical Reactions and Analyzing Products by FT-ICR and Ion-Trap Mass Spectrometry*. J. Am. Soc. Mass Spectrom. 16(6): 850-859.

Szopa, C., G. Cernogora, L. Boufendi, J. J. Correia and P. Coll (2006), *PAMPRE: A dusty plasma experiment for Titan's tholins production and study*. Planet. Space Sci. 54: 394-404.

Takayanagi, T., Y. Kurosaki, K. Sato and S. Tsunashima (1998), *Ab Initio Molecular Orbital Calculations for the N(2D) + Ethylene Reaction*. J. Phys. Chem. A 102(50): 10391-10398.

Teanby, N. A., P. G. J. Irwin, R. De Kok and C. A. Nixon (2010), *Mappint Titan's HCN in the far infra-red: implications for photochemistry*. Faraday Discuss. 147(3).

- Teanby, N. A., et al. (2007), *Vertical profiles of HCN, HC₃N, and C₂H₂ in Titan's atmosphere derived from Cassini/CIRS data*. *Icarus* 186(2): 364-384.
- Tobie G., O. Grasset, J.I. Lunine, A. Mocquet, C. Sotin (2005), *Titan's internal structure inferred from a coupled thermal-orbital model*. *Icarus* 175(2): 496-502
- Tran, B. N., J. C. Joseph, M. Force, R. G. Briggs, V. Vuitton and J. P. Ferris (2005), *Photochemical processes on Titan: Irradiation of mixtures of gases that simulate Titan's atmosphere*. *Icarus* 177(1): 106-115.
- Vinatier, S., et al. (2010), *Analysis of Cassini/CIRS limb spectra of Titan acquired during the nominal mission: I. Hydrocarbons, nitriles and CO₂ vertical mixing ratio profiles*. *Icarus* 205(2): 559-570.
- Vuitton, V., P. Lavvas, R. V. Yelle, M. Galand, A. Wellbrock, G. R. Lewis, A. J. Coates and J. E. Wahlund (2009), *Negative ion chemistry in Titan's upper atmosphere*. *Planet. Space Sci.* 57(13): 1558-1572.
- Vuitton, V., R. V. Yelle and M. J. McEwan (2007), *Ion Chemistry and N-containing molecules in Titan's upper atmosphere*. *Icarus* 191: 722-742.
- Waite, J. H., D. T. Young, T. E. Cravens, A. J. Coates, F. J. Crary, B. Magee and J. Westlake (2007), *The Process of Tholin Formation in Titan's Upper Atmosphere*. *Science* 316: 870-875.

- Wilson, E. H. and S. K. Atreya (2003), *Chemical sources of haze formation in Titan's atmosphere*. Planet. Space Sci. 51(14-15): 1017-1033.
- Yang, D. L., T. Yu, N. S. Wang and M. C. Lin (1992), *Temperature dependence of cyanogen radical reactions with selected alkanes: CN reactivities towards primary, secondary and tertiary C-H bonds*. Chem. Phys. 160: 307-315.
- Yelle, R. V., N. Borggren, V. de la Haye, W. T. Kasprzak, H. B. Niemann, I. Müller-Wodarg and J. J. H. Waite (2006), *The vertical structure of Titan's upper atmosphere from Cassini Ion Neutral Mass Spectrometer measurements*. Icarus 182(2): 567-576.
- Yelle, R. V., V. Vuitton, P. Lavvas, S. J. Klippenstein, M. A. Smith, S. M. Horst and J. Cui (2010), *Formation of NH₃ and CH₂NH in Titan's upper atmosphere*. Faraday Discussions 147(0): 31-49.
- Yu, Q., M. Ye, L. Lu, J. Chen and F. Wang (1988), *A study of the polymerization mechanism of acetonitrile in glow discharge*. Chin. J. Polym. Sci.6(2).
- Yung, Y. L. (1987), *An Update of Nitrile Photochemistry on Titan*. Icarus 72: 468-472.
- Zabarnick, S. (1989), *Kinetics of CN(X²S⁺) Radical reactions with HCN, BrCN and CH₃CN*. Chem. Phys. 134: 185-191.

Figure Caption:

Figure 1: **Schematic of the PAMPRE experimental setup**

Figure 2: **Evolution of the gas pressure measured in the cold trap after warming up to room temperature (red dots) and of the carbon gas to solid conversion yield (blue triangles, from Sciamma-O'Brien et al. (2010) as a function of CH₄ concentration)**

Figure 3 a,b,c: **Chromatograms of gas samples trapped during experiments with respectively 1% (Fig. 3a), 4% (Fig. 3b) and 10% CH₄ (Fig. 3c) from GC-MS analysis.** Peaks are numbered in agreement with Table 1. Minor peaks are shown in the insets.

Figure 4: **Experimental (up) and theoretical (down) spectra of tetrazolo[1,5-b]pyridazine. The topological scheme of tetrazolo[1,5-b]pyridazine is given in the down spectra.**

Figure 5: **Relative concentration of the nitriles as a function of the number of carbon in the molecules.** The red, green and blue dots represent the experimental data from this work, for experiments with 1%, 4% and 10% of methane in the reactor, respectively. The blue line is the empirical power law model ($y=ax^b$) associated to these experimental data. The dot-dashed line represents the model value plus 30% ($a'=a+30\%$; $b'=b-30\%$) while the dashed line is the model value minus 30% ($a''=a-30\%$; $b''=b+30\%$). The empty black diamonds and triangles are observational data (Vuitton et al. 2007 and reference herein), at 1100 and 300km from Titan's ground,

respectively. The full diamonds and triangles are data from computer modeling (Lavvas et al. 2008) at 1100 and 300 km from Titan's ground, respectively.

ACCEPTED MANUSCRIPT

Table 1: List of gaseous compounds detected in our experiment, in Titan's atmosphere and in other laboratory experiments

a: Cui et al., 2009; Robertson et al., 2009; Vuitton et al., 2007

b : Bernard et al., 2003

c : Ramírez et al., 2001; Ramírez et al., 2005

d : Tran et al., 2005

Compounds detected in our experiment	Formula	Peak identification in chromatogram of	Detected in Titan atmosphere	Detected in simulated
Nitrogenous compounds				
Hydrogen cyanide	HCN	6	a	b,c
Ammonia	NH ₃	4	a	b
Ethanedinitrile	C ₂ N ₂	5	a	b,c
Methyl isocyanide	C ₂ H ₅ N	13	a	
Acetonitrile	C ₂ H ₃ N	17	a	b,c,d
Propiolonitrile	HC ₃ N	16	a	b,d
2-Propenenitrile	C ₃ H ₃ N	19	a	c
Propanenitrile	C ₃ H ₅ N	23	a	c
2-methylpropanenitrile	C ₄ H ₇ N	25		c
Butanenitrile	C ₄ H ₇ N	27		c
C ₄ H ₅ N isomer	C ₄ H ₅ N	24	a	
C ₅ H ₇ N isomer	C ₅ H ₇ N			
Pentanenitrile	C ₅ H ₉ N			
Pentanedinitrile	C ₅ H ₆ N ₂			
Butanedinitrile	C ₄ H ₄ N ₂			
Butanenitrile,3-dimethyl	C ₅ H ₉ N			
Hydrocarbons				
Acetylene	C ₂ H ₂	2	a	b,c,d
Ethylene	C ₂ H ₄	1	a	b,c,d
Ethane	C ₂ H ₆	3	a	b,c,d
Allene	C ₃ H ₄	8		b,c
Propyne	C ₃ H ₄	9	a	b,c,d
Propene	C ₃ H ₆		a	c,d
Propane	C ₃ H ₈	7	a	b,c,d
1-Buten-3-yne	C ₄ H ₄	14		c
C ₄ H ₆ isomer	C ₄ H ₆	18	a	c,d
C ₄ H ₈ isomer	C ₄ H ₈	12		c,d
n-Butane	C ₄ H ₁₀	15		c,d
i-Butane	C ₄ H ₁₀	11		c,d
C ₅ H ₈ isomer	C ₅ H ₈	22		c

C ₅ H ₁₀ isomer	C ₅ H ₁₀	20		c,d
n-Pentane	C ₅ H ₁₂	21		c,d
Aromatic species				
Tetrazolo[1,5-b]pyridazine	C ₄ H ₃ N ₅	26		
Triazine	C ₃ H ₃ N ₃			
Benzene	C ₆ H ₆		a	c,d
Pyrrole	C ₄ H ₅ N			
Other species				
Methanol	CH ₃ OH	10		
Ethanol	C ₂ H ₅ OH			
Acetone	C ₂ H ₆ O			

Table 2: Evolution of ρ , the ratio of nitrogen bearing compounds versus hydrocarbon compounds detected in our experiment as a function of methane concentration of the gas mixture injected in the plasma reactor

CH₄ concentration	1%	1%	4%	10%	10%
n _N	7	11	19	12	16
n _{CH}	2	3	6	15	17
ρ	3.5	3.7	3.2	0.8	0.9

Table 3: Calculated ionization cross section of the nitriles. The calculation is performed using the formula proposed in Fitch and Sauter (1983).

Compounds	Formula	Q ($\times 10^{-16}$ cm ²)	$\frac{Q_{HCN}}{Q_{RCN}}$
Hydrogen Cyanide	HCN	3.442	1
Acetonitrile	C ₂ H ₃ N	6.332	0.544
Propanenitrile	C ₃ H ₅ N	9.222	0.373
Butanenitrile	C ₄ H ₇ N	12.112	0.284
Isobutyronitrile	C ₄ H ₇ N	12.112	0.284

>We studied the gas composition in a Titan's atmospheric simulation. >We performed a relative concentration of some nitriles. >Experimental data allowed a model for nitrile's concentrations. >Model fits both numerical models and observations.

ACCEPTED MANUSCRIPT