



**HAL**  
open science

## Application of Evidential Networks in quantitative analysis of railway accidents

Felipe Aguirre, Mohamed Sallak, Walter Schon, Fabien Belmonte

► **To cite this version:**

Felipe Aguirre, Mohamed Sallak, Walter Schon, Fabien Belmonte. Application of Evidential Networks in quantitative analysis of railway accidents. Proceedings of the Institution of Mechanical Engineers, Part O: Journal of Risk and Reliability, 2013, 227 (4), pp.368-384. 10.1177/1748006X12475044 . hal-00749617

**HAL Id: hal-00749617**

**<https://hal.science/hal-00749617>**

Submitted on 8 Nov 2012

**HAL** is a multi-disciplinary open access archive for the deposit and dissemination of scientific research documents, whether they are published or not. The documents may come from teaching and research institutions in France or abroad, or from public or private research centers.

L'archive ouverte pluridisciplinaire **HAL**, est destinée au dépôt et à la diffusion de documents scientifiques de niveau recherche, publiés ou non, émanant des établissements d'enseignement et de recherche français ou étrangers, des laboratoires publics ou privés.

# Application of Evidential Networks in quantitative analysis of railway accidents

Felipe Aguirre<sup>1</sup>, Mohamed Sallak<sup>1</sup>, Walter Schön<sup>1</sup>, and Fabien Belmonte<sup>2</sup>

<sup>1</sup>Compiegne University of Technology, UMR CNRS 7253

Heudiasyc BP 20529, 60205 Compiegne cedex, France

<sup>2</sup>Alstom Transport

48 rue Albert Dhalenne, 93482 Saint-Ouen cedex, France

{felipe.aguirre-martinez, mohamed.sallak, walter.schon}@utc.fr,

fabien.belmonte@transport.alstom.com

## ABSTRACT

Currently, a high percentage of accidents in railway systems are accounted to human factors. As a consequence, safety engineers try to take into account this factor in risk assessment. However, human reliability data are very difficult to quantify, thus, qualitative methods are often used in railway system's risk assessments. Modeling of human errors through probabilistic approaches has shown some limitation concerning the quantification of qualitative aspects of human factors. The proposed paper presents an original method to account for the human factor by using Evidential Networks and fault tree analysis.

## KEY WORDS

Railway accidents, Belief functions theory, Evidential Networks, epistemic uncertainty, Experts' opinion.

## I. INTRODUCTION

There is little doubt that human error is the most significant source of accidents or incidents in railway systems. According to statistics of railway accidents in Korea, human errors have accounted for 61% of all train accidents from 1995 to 2004. The purpose of Human Reliability Analysis (HRA) is to include the likelihood of human actions that may cause hazardous events occurring during the qualitative or quantitative evaluation of risk. Several new techniques for HRA were invented in the last decades: THERP [SG83], HEART [Wi86], JHEDI [Kir90], etc. These techniques have been often attacked as being of dubious validity [Rea90], [Hol93]. One of the main critics is that human performance is not easy to quantify due to a large number of factors affecting it and the variability of one person over others. Nevertheless, studies have been made to prove the performance of current methods [Kir96],

[KKTAL97], [Kir97], [BH09], [BFB<sup>+</sup>10]. One of their drawbacks is that performance factors are dependent of the working context and a validation of the experimental data must be done. This suggest that there is a need for new methods of HRA [HAH10].

Moreover, in the field of railway systems there has been few attempts to include human factors in safety analysis [BSHC11]. Some of the factors which cause the occurrence of human error in the railway systems are classed in four categories [KA96]: (1) automatic action-automatism, which is a kind of human habitude, (2) imperative idea, which is a kind of desire to do something without any reason, (3) the condition and capacity of the faculty of observation possessed by the observers, which contain mental alienation, toxic action of drugs or liquors, inefficient training, defect in the special sense like acuteness of hearing, color-blindness, acuteness of vision, etc, (4) the mental condition of the observers and their capacity at the time for the correct interpretation of what is to be observed, which contain overwork, anxiety, depressed conditions, impaired mental condition, etc. A method was developed by Vanderhaegen *et al.* to analyze the consequences of human unreliability on railway system safety [Van99], [Van01]. The human behavioral degradations were characterized by a behavioural model of human unreliability which included three behavioral factors: acquisition related factors, problem solving related factors and action related factors. Baysari *et al.* [BMW08] used the Human factors analysis and classification system (HFACS) method to identify errors in railway and human factors contribution in accidents and incidents in Australia. In this method, four errors types were proposed: unsafe acts, preconditions for unsafe acts, unsafe supervision and organizational influences. Unsafe acts contain errors (skill based, decision, perception) and violations (routine, exceptional), preconditions for unsafe acts contain condition of operators (adverse mental states, adverse physiological states, physical/mental limitation), personnel factors (crew resource management, personal readiness) and environmental factors (physical environment, technological environment), unsafe supervision contains inadequate supervision, planned inappropriate operations, failed to correct a known problem and supervisory violations, organizational influences contain resource management (human resources, monetary/budget resources, equipment/facility resources), organizational climate (structure, policies, culture) and organizational process (operations, procedures, oversight). From the classification of error types, the causes of human errors can be deduced. In 2009, two human error identification techniques were used by Baysari *et al.* [BCMW09] in railway systems: HFACS method and the Technique for the retrospective and predictive analysis of cognitive errors (TRACER-Rail version). HFACS method identified errors of all operators in railway systems, but TRACE-Rail method identified only errors of drivers. In TRACE-Rail method, factors which cause driver errors were listed as follows: train/infrastructure/traffic, communications, procedures/documentation, information, training/knowledge/experience, workplace design/human-machine interaction/equipment, in-cab environment, personal factors and social and team factors. In [KBY10], kim *et al.* explained that human error analysis was a time-consuming task and a computer-aided system which helps to analysis human error in railway systems

was developed. This system supported the hierarchy of error causes and the relations between these causes because of predefined links. In this system, thirteen categories of human error causes that influenced the occurrence of the human error were proposed: mental states of operators, physical states of operators, knowledge/experiences/ability of operators, task characteristics, tools/equipment, work environment, train/infrastructure, rules/procedures, human resource management, communication, team factors, supervision and organizational processes/policies/culture. More details can be added into each category (physical states of operators contain physical fatigue, physical illness, alcohol or drug use, temporary visual or hearing impairment, physical properties, general motor ability and age/gender, etc.). In [BSHC11], Belmonte *et al.* presented an application of Functional Resonance Accident Models (FRAM) in safety analysis of railway traffic supervision using modern Automatic Train Supervision (ATS) systems. This study included not only technological, but also human and organizational components.

However, these works are mostly of a qualitative nature mainly because of the difficulty to quantify human behaviour. As stated by R.L. Boring et al. [BFB<sup>+</sup>10] one of the lessons learned on benchmarking from the international human reliability analysis empirical study is the fact that taking into account both qualitative and quantitative elements in the prediction of HRA methods allowed a more complete understanding of the HRA methods' strengths and weaknesses in predicting equipments performance. Human behaviour is considered as surrounded by epistemic uncertainties, thus needing the use of proper theories to represent and propagate the uncertainty in risk analysis. As stated by M. Konstandinidou et al. [KNKM06a] the limitations in the analysis of human actions in PRAs are always recognized as a constraint in the application of PRA results. The fundamental limitations are as follows:

- insufficient data.
- methodological limitations related to subjectivity of analysts and expert judgment.
- uncertainty concerning the actual behaviour of people during accident conditions.

During the last decades, the reliability assessment community recognized that the distinction between different types of uncertainties plays an important role in reliability evaluation [Apo90], [AN10]. Uncertainty is considered of two types: aleatory uncertainty which arises from natural stochasticity and epistemic uncertainty which arises from incompleteness of knowledge or data [OHJ<sup>+</sup>04]. The distinction is useful because epistemic uncertainty can be reduced by acquiring knowledge on the studied system.

The classical probabilistic approach was widely used to manage aleatory uncertainties in risk and reliability assessments [Ave11]. This approach was based on the definition given by Laplace of the probability of an event as the ratio of the number of cases favorable to it, to the number of all possible cases when all cases are equally possible [Lap51]. The frequentist probabilistic approach introduced by Venn [Ven66] which defined the event probability as the limit of its relative frequency in a large number of trials was also widely used to describe aleatory uncertainties.

To describe epistemic uncertainties, De Finetti [Fin74] introduced the subjective probabilities of an event to indicate the degree to which the expert believes it. Kaplan and Garrik [KG81] introduced the concept of probability of frequency to expand their definition of risk. Pate-Cornell [Cor96] used the six level of uncertainty to obtain a family of risk curves in presence of both aleatory and epistemic uncertainties. The Bayesian approach proposed the use of subjective probabilities to represent expert judgement. The probability distributions representing the aleatory uncertainties are first proposed. The epistemic uncertainties about the parameter values of the distributions are then represented by prior subjective probability distributions [KG81]. The equation of Bayes is used to compute the new epistemic uncertainties in terms of the posterior distributions in case of new reliability data. Finally, the predictive distributions of the quantities of interest are derived by using the total probability law. The predictive distributions are subjective but they also take into account the aleatory uncertainties represented by the prior probability models [Apo90].

However, There are some critics about representing epistemic uncertainties using subjective probabilities. Particularly, in the case of components that fail only rarely such as railway systems or components that have not been operated long enough to generate a sufficient quantity of data. This is also the case of human errors. As stated by M. Konstandinidou *et al.* [KNKM06b] the limitations in the analysis of human actions in PRAs are always recognized as a constraint in the application of PRA results. The fundamental limitations are as follows:

- insufficient data.
- methodological limitations related to subjectivity of analysts and expert judgement.
- uncertainty concerning the actual behaviour of people during accident conditions.

In this work we are concerned with the problem of data insufficiency. For example, when there is few information about the value of a parameter  $\alpha$ , the choice of probability distribution may not be appropriate. For example, there is a difference between saying that all that is known about the parameter  $\alpha$  is that its value is located somewhere in an interval  $[x, y]$  and saying that a uniform distribution on  $[x, y]$  characterizes degrees of belief with respect to where the value of this parameter is located in the interval  $[x, y]$  [HJOS07], [Ave11]. Furthermore, in a situation of ignorance a Bayesian approach must equally allocate subjective probabilities over the frame of discernment. Thus there is no distinction between uncertainty and ignorance. A number of alternatives theories based on different notions of uncertainty were proposed to capture the imprecision in subjective probabilities.

Baudrit *et al.* [BDG06] explained that random variability can be represented by probability distribution functions, imprecision (or partial ignorance) is better accounted for by possibility distributions (or families of probability distributions) and thus propose a hybrid method which jointly propagates probabilistic and possibilistic uncertainty in risk assessment. Tucker *et al.* [TF03] propose probability bounds analysis which combines probability theory and interval arithmetic to produce probability boxes (p-boxes), structures that allow the comprehensive propagation of

both variability and uncertainty through calculations in a rigorous way. The belief functions theory also known as the Dempster-Shafer or evidence theory is a generalization of the Bayesian theory of subjective probability. Whereas the Bayesian theory requires probabilities for each question of interest, belief functions allow us to base degrees of belief for one question on probabilities for a related question [Sme93]. To illustrate the idea of obtaining degrees of belief for one question from subjective probabilities for another, we propose an example in risk assessment inspired from the example of limb given by Shafer. Suppose we have subjective probabilities for the reliability of a risk expert A. The probability that A is reliable is 0.75, and the probability that A is not reliable is 0.25. The risk expert A reports us that a component  $i$  is failed. This information which must be true if A is reliable, is not necessarily false if A is not reliable. The risk expert testimony justifies a 0.75 degree of belief that the component  $i$  is failed, but only a 0 degree of belief (not a 0.25 degree of belief) that the component  $i$  is not failed. This value does not mean that we are sure that the component  $i$  is failed, as a zero probability would. It means that the risk expert's testimony gives us no reason to believe that the component  $i$  is failed. The 0.75 and the 0 constitute a belief function. Thus there is no requirement that belief not committed to a given proposition should be committed to its negation. The second point of evidence theory is that belief measures of uncertainty may be assigned to overlapping sets and subsets of hypotheses, events or propositions as well as to individual hypothesis. D-S theory which can be considered as an alternative approach to represent uncertainties has gained an increasing amount of attention both from the theoretical and the applied point of view [Gut91], [Ina91], [SW09], [SSA10]. In a finite discrete space, D-S theory is a generalization of probability theory where probabilities are assigned to sets instead of mutually exclusive singletons. This theory is still a young field compared to other theories and its main application is data fusion.

This paper presents an original method to integrate, in a quantitative way, the human, organizational and technical factors to risk analysis in railway accidents using belief functions theory. We use a graphical model called Evidential Networks (ENs) on which we quantify beliefs given by experts and the relationships between the different factors through a valuation network. The advantage of such method is that it presents a natural and intuitive way for the experts to understand and use the model. To make an analogy, one can say that ENs are to belief functions as Bayesian networks (BNs) are to probability theory. They are both used to represent and propagate our beliefs but the deployment of Bayesian networks is sometimes inadequate for situations involving partial or total ignorance [Sim08]. Take for example the study done by Contini et al. [CAZ91], they provided the same reference subject (an ammonia storage facility) to 11 teams representing control authorities, research organizations, engineering companies and industries. After a complete probabilistic risk assessment was performed, the results differed over several orders of magnitude. This is a direct evidence that eliciting precise probabilities can conduct to abusively precise values as they can differ greatly from one expert to another. On the contrary, as ENs are based on belief functions theory,

ignorance or imprecise knowledge can be easily modeled by using lower and upper estimates of the different factors. This way our models can be more conservative and more representative of our real state of knowledge. More precisely, This paper proposes four contributions:

- 1) How to construct human reliability data in the belief functions framework (we added this section to the paper) from both observations and experts' opinion with some basic examples.
- 2) How to combine experts' opinion in the belief functions framework.
- 3) A general method to apply Evidential networks and FT in the evaluation of belief occurrence of accidents.
- 4) An application of the proposed approach in the evaluation of belief occurrence of a railway accident and a comparison with results obtained using classical approaches based on Monte-Carlo simulations.

The remainder of the paper is organized as follows. In Section 2, we provide a background of belief functions theory. In Section 3, some basic notions of Valuations Based Systems (VBSs) and ENs are presented. In Section 4, we describe the development of the combined EN and Fault Tree (FT) model. Section 4 demonstrates the proposed methodology on the example of a railway accident. Section 5 concludes the paper.

## II. BELIEF FUNCTIONS THEORY

In the 1960's, Dempster [Dem67] gave birth to the DS theory also called evidence theory or belief functions theory with the study of upper and lower probabilities. Later on, it was extended by Shafer in 1976 [Sha76]. Belief functions theory can be seen as an extension of the Bayesian probability theory. The first work using belief functions theory in reliability and risk assessment was presented by Dempster and Kong [DK88]. In recent years, the belief functions theory was used by many researchers in order to quantify the uncertainty in reliability and risk assessment studies [Alm95], [BGC04], [LS07], [UG08], [PS08], [SW09], [SSA10].

### A. Representing information

The definition domain of the variable of interest  $x$  is called the frame of discernment  $\Omega$  where all of the possible events are mutually exclusive elementary propositions. It is equivalent to the sample space in probability theory. A Basic Belief Assignment (BBA) on  $\Omega$ , also called Basic Probability Assignment (BPA), is a function,  $m^\Omega : 2^\Omega \rightarrow [0, 1]$ , which maps probability masses on events or subsets of events such that:

$$\sum_{A \in 2^\Omega} m^\Omega(A) = 1 \quad (1)$$

An agent holding a piece of evidence allocates unitary amounts of beliefs to the different subsets of  $\Omega$ . The number  $m^\Omega(A)$  represents the support of A given by the agent's belief [Sme90]. There is a distinction between probabilities and BBAs: probability distribution functions are defined on  $\Omega$  and BBAs on the power set  $2^\Omega$ . Moreover

the additivity hypothesis is not required in belief functions theory as it is in probability theory. The subsets  $A \subset \Omega$  such that  $m^\Omega(A) > 0$  are called focal sets of  $m^\Omega$ . Full knowledge is represented by a BBA having a singleton  $\{x\}$  ( $x \in \Omega$ ) as a unique focal set. A Bayesian BBA is a special case where all of the focal sets are singletons and is equivalent to probabilities. Complete ignorance is represented by a BBA having only one focal element equal to  $\Omega$  and is called vacuous. Finally BBAs have some other properties, that distinguishes them from probability functions [GF99]:

- It is not necessary that  $m(\Omega) = 1$ .
- It is not necessary that  $m(A) \leq m(B)$  when  $A \subseteq B$ .
- $m(A) + m(\bar{A})$  is not always equal to 1.

*B. Belief and plausibility functions*

A belief function  $Bel$  on  $\Omega$  is a function  $Bel : 2^\Omega \rightarrow [0, 1]$  defined as follows:

$$Bel(A) = \sum_{B \subseteq A} m^\Omega(B), \quad A \subseteq \Omega \tag{2}$$

As we impose the closed world hypothesis that states that the answer is strictly found inside our frame of discernment, we add two constraints to the belief function:  $Bel(\Omega) = 1$  and  $Bel(\emptyset) = 0$ . The inverse formula called the Möbius transform of  $Bel$  is defined as follows:

$$m(A) = \sum_{B \subseteq A} (-1)^{|A|-|B|} Bel(B) \tag{3}$$

Where  $|A|$  represents the cardinality of  $A$ . A plausibility function  $Pl$  on  $\Omega$  is a function  $Pl : 2^\Omega \rightarrow [0, 1]$  defined as follows:

$$Pl(A) = \sum_{B \cap A \neq \emptyset} m^\Omega(B), \quad A \subseteq \Omega \tag{4}$$

$Bel(A)$  is obtained by summing the BBAs of the propositions that totally agree with  $A$  whereas  $Pl$  is obtained by summing BBAs of propositions that agree with  $A$  totally or partially (cf. Figure 1).  $[Bel(A), Pl(A)]$  can be viewed as the interval that describes the uncertainty of  $A$ .  $Bel$  and  $Pl$  are related by:

$$\begin{aligned} Pl(A) + Bel(\bar{A}) &= 1 \\ Pl(\bar{A}) + Bel(A) &= 1 \end{aligned} \tag{5}$$

Where  $\bar{A}$  is the negation of the event  $A$ .



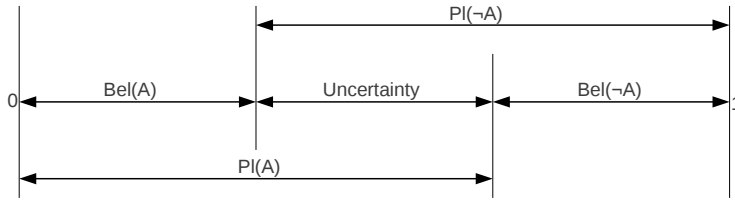

Fig. 1: Belief and Plausibility functions

C. Combination operations

The purpose of information aggregation related to event occurrence is to summarize data whether the data is coming from a single source or multiple sources. There are many aggregation techniques such as arithmetic averages, geometric averages, harmonic averages, maximum and minimum values. Combination rules are the types of aggregation techniques for data obtained from multiple sources which provide different assessments for the same event.

Consider two distinct and independent pieces of evidence  $m_i^\Omega$  and  $m_j^\Omega$  from two different and reliable sources  $i$  and  $j$ . In belief functions theory, the principal combination rules are the conjunctive and disjunctive combination rules [Sha76]. The conjunctive combination is given by:

$$m_{i \cap j}^\Omega(H) = \sum_{A \cap B = H, \forall A, B \subseteq \Omega} m_i^\Omega(A) m_j^\Omega(B), \forall H \subseteq \Omega \quad (6)$$

The disjunctive combination is given by:

$$m_{i \cup j}^\Omega(H) = \sum_{A \cup B = H, \forall A, B \subseteq \Omega} m_i^\Omega(A) m_j^\Omega(B), \forall H \subseteq \Omega \quad (7)$$

The Dempster's rule of combination is the fundamental rule in belief functions theory for combining items of evidence. This rule is defined as the conjunctive combination of two BBAs followed by a normalization:

$$m_{i \oplus j}^\Omega(H) = \begin{cases} \frac{m_{i \cap j}^\Omega(H)}{1-k} & \text{if } H \neq \emptyset \\ 0 & \text{otherwise} \end{cases} \quad (8)$$

With:

$$k = \sum_{A \cap B = \emptyset, \forall A, B \subseteq \Omega} m_i^\Omega(A) m_j^\Omega(B) \quad (9)$$

$k$  is called the conflict factor between the two pieces of evidence  $i$  and  $j$ .

#### D. Conditioning

The conditioned mass function is intended to represent the impact of additional information. The conditioning in belief functions theory is used both for prediction from observations and revision of uncertain information [AH12]. When dealing with prediction, we have at our disposal a model of the world (e.g., belief occurrence degrees of principals causes of a human error) under the form of a BBAs distribution. Moreover we get some new observations  $B$  on the current state of the world (e.g., occurrence of one cause of human error). Then, one tries to predict some property  $A$  of the current world with its associated degree of belief (e.g. predict the human error occurrence). The conditional BBA  $m(A|B)$  (the belief of observation of  $A$  in context  $B$ ) is used for estimating the degree of belief that the current world satisfies  $A$ . Conditioning in belief functions theory requires a sort of independence. Define the mass function  $m$ , the conditional of  $m$  given  $B$  for  $A \subseteq \Omega$  is given by

$$m(A|B) = K \sum_{C|C \cap B = A} m(C) \quad (10)$$

where  $K$  is the normalisation factor defined by  $K^{-1} = \sum_{C|C \cap B \neq \emptyset} m(C)$ .

For example  $m(e_i|\theta_i) = 0.2$  means that when an expert receives a new information  $\theta_i$ , his degree of belief that "an human error  $e_i$  will occur" is 0.2.

### III. BASICS OF VALUATION-BASED SYSTEMS (VBS) AND EVIDENTIAL NETWORKS (ENS)

The VBSs were introduced by Shenoy in 1989 as general frameworks for managing uncertainty in expert systems [She89]. In rule-based languages, a domain knowledge is represented by variables and rules. The operator used to make inferences from the knowledge is modus ponens which can be summarized as:  $p$  implies  $q$ ;  $p$  is asserted to be true, so therefore  $q$  must be true. A categorical rule is a rule defined without uncertainty. In Valuation-Based Languages (VBL), a domain knowledge is represented by variables and valuations. The operators used to make inferences from the knowledge are called combination and marginalization. Thus the VBL have two parts: a static part that is concerned with representation of knowledge, and a dynamic part that is concerned with reasoning with knowledge. For more details, see [She89].

#### A. Valuation based language (VBL)

##### Static part

Let  $X$  denote a variable. The set of its possible values will be denoted by  $\Omega_X$  and referred to as the frame of  $X$ . If  $h$  is a non empty set of variables then  $\Omega_h$  denotes the Cartesian product of  $\Omega_X$  for  $X \in h$ :  $\Omega_h = \times \{\Omega_X | X \in h\}$ . We call  $\Omega_h$  the frame for  $h$ . The elements of  $\Omega_h$  are called configurations of  $h$ .

A valuation  $V_h$  on  $h$  represents some knowledge about the variables in  $h$ . The set  $V$  represents the set of all valuations, i.e:  $V_E = \cup\{V_h|h \subseteq E\}$  where  $E$  is a finite set of variables.

*Dynamic part*

A crucial point in VBL is the use of local computations to optimize the propagation of beliefs. In order to compute marginals on the joint valuation, the local computations use two operations called combination and marginalisation. The combination is a mapping  $\otimes : V \times V \rightarrow V$  used to combine valuations  $G$  and  $H$  on  $g$  and  $h$  to produce valuation  $G \otimes H$  on  $g \cup h$ .

The marginalization is a mapping  $\downarrow h : \cup\{V_g|h \subseteq g\} \rightarrow V_h$  used to produce valuations on subsets of the given set of variables such that if  $G$  is a valuation on  $g$  and  $h \subseteq g$ , then  $G^{\downarrow h}$  is a valuation on  $h$ .  $G^{\downarrow h}$  is called the marginal of  $G$  to  $h$ .

A VBL makes inference by first combining all valuations in the system in order to obtain the joint valuation. Then the marginalization operation is used to obtain the marginal of the variable of interest.

*B. Evidential Systems (ES)*

A VBS is a formal mathematical system for representation of and reasoning with knowledge. It consists of a 5-tuple  $\{E, \Omega_E, V_E, \otimes, \downarrow\}$  where  $E$  denote a finite set of variables  $E$ ,  $\Omega_E$  denote the set of frames, and  $V_E$  the set of all valuations.

The graphical representation of a VBS is a graph called a valuation network where the nodes represent either valuations or variables. When the valuations are expressed using BBAs, the VBS is called an Evidential System (ES).

A categorical rule  $x_1 \wedge x_2 \wedge \dots \wedge x_n \rightarrow y$  is represented by a categorical BBA on the frame  $\Omega_{X_1} \times \Omega_{X_2} \times \dots \times \Omega_{X_n} \times \Omega_Y$ . Consider two variables  $X$  and  $Y$  and let  $\Omega_X = \{x, \bar{x}\}$  and  $\Omega_Y = \{y, \bar{y}\}$  denote their frames. The categorical rule  $x \rightarrow y$  is then defined as follows [BCFR08]:

$$m^{\Omega_X \times \Omega_Y}(\{(x, y), (\bar{x}, y), (\bar{x}, \bar{y})\}) = 1 \tag{11}$$

On the other hand, if we hold some doubt about the rule  $x \rightarrow y$ , our degree of belief can be quantified as follows:

$$\begin{aligned} m^{\Omega_X \times \Omega_Y}(\{(x, y), (\bar{x}, y), (\bar{x}, \bar{y})\}) &= p \\ m^{\Omega_X \times \Omega_Y}(\{\Omega_X \times \Omega_Y\}) &= 1 - p \end{aligned} \tag{12}$$

Consider for example a study to evaluate the reliability of a risk expert  $E$ . We know that at least 80% of risk experts which are working in factory A are not reliable and at least 90% of risk experts which are working in

TABLE I: Beliefs and plausibility measures for the example

$R$	Initial situation		Information 1		Information 2	
	$Bel(\{R\})$	$Pl(\{R\})$	$Bel(\{R\})$	$Pl(\{R\})$	$Bel(\{R\})$	$Pl(\{R\})$
$\{r\}$	0	1	0	0.2	0.6429	0.7143
$\{\bar{r}\}$	0	1	0.8	1	0.2857	0.3571
$\{r, \bar{r}\}$	1	1	1	1	1	1

factory B are reliable.

We suppose that the variables  $A = a$ ,  $B = b$  and  $R = r$  represent, respectively, the propositions "the risk expert  $E$  works in factory  $A$ ", "the risk expert  $E$  works in factory  $B$ ", "the risk expert  $E$  is reliable". The BBAs representing the fact that at least 80% of risk experts which working in factory A are not reliable are:

$$\begin{aligned}
 m_1^{\Omega_A \times \Omega_R}(\{(a, \bar{r}), (\bar{a}, r), (\bar{a}, \bar{r})\}) &= 0.8 \\
 m_1^{\Omega_A \times \Omega_R}(\{\Omega_A \times \Omega_R\}) &= 0.2
 \end{aligned}
 \tag{13}$$

The BBAs representing the fact that at least 90% of risk experts which working in factory B are reliable are:

$$\begin{aligned}
 m_2^{\Omega_B \times \Omega_R}(\{(b, r), (\bar{b}, r), (\bar{b}, \bar{r})\}) &= 0.9 \\
 m_2^{\Omega_B \times \Omega_R}(\{\Omega_B \times \Omega_R\}) &= 0.1
 \end{aligned}
 \tag{14}$$

The obtained EN is shown in Figure 2. First we suppose that we have no prior BBAs about the fact that the expert  $E$  works in factory A or B, i.e:

$$\begin{aligned}
 m_0^{\Omega_A}(\{a, \bar{a}\}) &= 1 \\
 m_0^{\Omega_B}(\{b, \bar{b}\}) &= 1
 \end{aligned}
 \tag{15}$$

The preliminary results obtained using Dempster rule of combination, without receiving any information, is that the belief interval that the expert  $E$  is reliable is  $[0,1]$  (cf. Table I). Then, we receive the information 1 that the expert  $E$  works in factory A. This information is represented by  $m_0^{\Omega_A}(\{a\}) = 1$ . The obtained belief interval that the expert is not reliable is  $[0.8,1]$ . Finally we received the second information that the expert  $E$  works also in factory B which is represented by  $m_0^{\Omega_B}(\{b\}) = 1$ . As we can see, this information weakens the fact that the expert  $E$  is not reliable which justify the fact that the obtained belief interval that the expert is not reliable is  $[0.2857,0.3571]$  (cf. Table I).

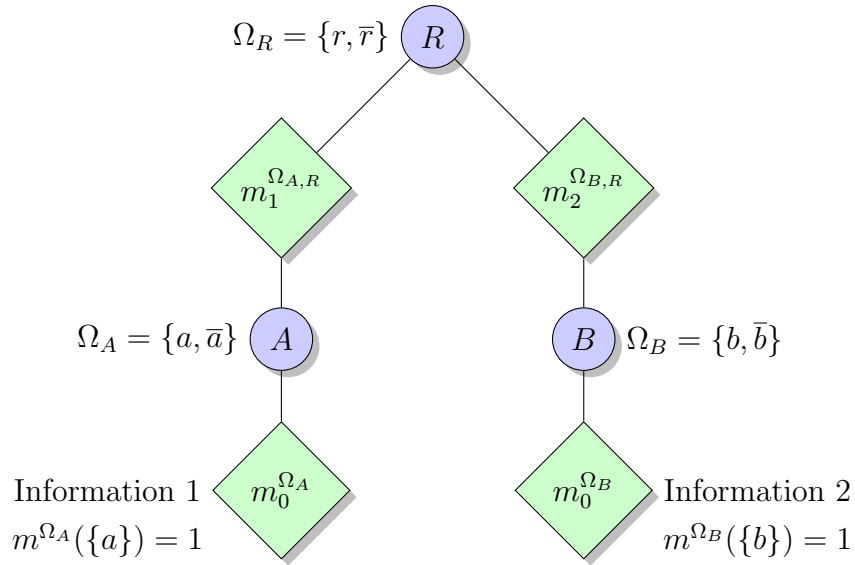

Fig. 2: EN for the risk expert example

#### IV. CONSTRUCTION OF RELIABILITY DATA

In railway risk assessment, there are two different sources of information available about the human errors

- Expert opinion in the form of values or bounds on human errors in presence of some events.
- Data in form of number of human errors in presence of some events or time of observations.

##### A. Lower and Upper Expectations

We first need to introduce some basic concepts. Let  $\mathcal{B}(\mathbb{R})$  be a Borel  $\sigma$ -algebra, and let  $m$  be a Basic Belief Assignment (BBA) and  $Bel$  and  $Pl$  the associated belief and plausibility functions. Let  $\Pi$  be the set of probability measures compatibles with  $Bel$  and  $Pl$ . A probability measure  $P \in \Pi$  is said to be compatible with  $Bel$  and  $Pl$  if for each  $A \in \mathcal{B}(\mathbb{R})$

$$Bel(A) \leq P(A) \leq Pl(A) \tag{16}$$

The lower and upper expectations of a measurable, bounded and real-valued function  $f$  with respect to  $m$  are defined as follows [Was90]

$$\underline{\mathbb{E}}_m(f) = \inf_{P \in \Pi} \mathbb{E}_P(f) \quad \text{and} \quad \overline{\mathbb{E}}_m(f) = \sup_{P \in \Pi} \mathbb{E}_P(f) \tag{17}$$

where  $\mathbb{E}_P(f) = \int f(\alpha)P(d\alpha)$  denotes the expectation of function  $f$  with respect to  $P$ .

Lower expectations can be obtained from upper expectations through the expression

$$\underline{\mathbb{E}}_m(f) = -\overline{\mathbb{E}}_m(-f) \tag{18}$$

It can be shown that in the continuous case [Was90]

$$\mathbb{E}_m(f) = \int_{-\infty}^{+\infty} \int_u^{+\infty} f(u, v) \inf_{u \leq x \leq v} f(x) dv du \quad \text{and} \quad \bar{\mathbb{E}}_m(f) = \int_{-\infty}^{+\infty} \int_u^{+\infty} f(u, v) \sup_{u \leq x \leq v} f(x) dv du \quad (19)$$

In the discrete case, we have [Dem67]

$$\mathbb{E}_m(f) = \sum_{i=1}^n m_i \inf_{x \in I_i} f(x) \quad \bar{\mathbb{E}}_m(f) = \sum_{i=1}^n m_i \sup_{x \in I_i} f(x) \quad (20)$$

*B. Construction of human errors data based on experts opinions*

Let  $X$  be a indicator variable for the occurrence of a human error in the presence on an event. The occurrence of a human error is a Bernoulli process with a parameter  $p$  correspond to the occurrence of error and  $1 - p$  corresponds to the absence of error. Thus we have

$$\begin{aligned} Bel(X = 1) &= \mathbb{E}_m(p) \\ &= \sum_{i=1}^n m(I_i) \min_{p \in I_i} p \\ &= \sum_{i=1}^n m_i u_i \end{aligned} \quad (21)$$

$$\begin{aligned} Pl(X = 1) &= \bar{\mathbb{E}}_m(p) \\ &= \sum_{i=1}^n m(I_i) \max_{p \in I_i} p \\ &= \sum_{i=1}^n m_i v_i \end{aligned} \quad (22)$$

Where  $I_i = [u_i, v_i]$  and  $m(I_i) = m_i$ .

The obtained BBAs are

$$\begin{aligned} m(\{1\}) &= \sum_{i=1}^n m_i u_i \\ m(\{0\}) &= \sum_{i=1}^n m_i v_i \\ m(\{0, 1\}) &= 1 - \sum_{i=1}^n m_i v_i \end{aligned} \quad (23)$$

Example 1: Suppose an expert provides his opinion that in the presence of noisy environment there is 0.3 a chance that the parameter  $p$  indicating the occurrence of human error lies between and 0.003 and 0.005, and a there is 0.5 chance that  $p$  lies between and 0.007 and 0.01. This suggests a mass function over  $[0,1]$  expressing the expert's opinions about  $p$  with three focal elements  $[0.003,0.005]$ ,  $[0.007,0.01]$  and  $[0,1]$  which have mass values 0.3, 0.5,

and 0.2 respectively. Then we have

$$Bel(X = 1) = 0.003 * 0.3 + 0.007 * 0.5 + 0 * 0.2 = 0.0044$$

$$Pl(X = 1) = 0.005 * 0.3 + 0.01 * 0.5 + 1 * 0.2 = 0.2065$$

Thus the occurrence of human error  $p$  in presence of noisy environment is given by:  $p \in [0.0044, 0.2065]$ .

### C. Construction of human errors data based based on observations

Let us now assume that, instead of eliciting expert opinion, we have made  $n$  independent observations  $X_1, \dots, X_n$  of  $X$ . Given data of  $x$  human errors in  $n$  presence of noisy environment, what is the probability of human error in presence of noisy environment. The formulas for the upper and lower expectation of  $p$  are defined as follows:

$$\underline{\mathbb{E}}_m[p] = \frac{x}{n+1} \quad (24)$$

$$\overline{\mathbb{E}}_m[p] = \frac{x+1}{n+1} \quad (25)$$

Example 2: Suppose in 15 observations, we have human errors in 3 observations. Then we have

$$\underline{\mathbb{E}}_m[p_1] = \frac{3}{16} = 0.1875 \quad (26)$$

$$\overline{\mathbb{E}}_m[p_1] = \frac{4}{16} = 0.2500 \quad (27)$$

The occurrence of human error  $p_1$  in presence of noisy environment is given by:  $p_1 \in [0.1875, 0.2500]$ .

In the case we use the observations made in an other railway system (prior belief): in 35 observations, we have human errors in 5 observations

$$\underline{\mathbb{E}}_{m'}[p_2] = \frac{5}{35} = 0.1429 \quad (28)$$

$$\overline{\mathbb{E}}_{m'}[p_2] = \frac{6}{35} = 0.1714 \quad (29)$$

In this case, the occurrence of human error  $p_2$  in presence of noisy environment is given by:  $p_2 \in [0.1429, 0.1714]$ .

Finally, the aggregation of the two observations give:  $p_{12} \in [0.1429, 0.2500]$ .

### D. Comparison with Laplace, LME (Maximum Likelihood Estimate) and Bayesian approaches

As shown in Table II, all three methods (Laplace, LME and Bayesian approaches) are contained within the upper and lower expectations given by belief functions. Furthermore, as  $n \rightarrow +\infty$  the upper and lower bounds of the belief function converge, yielding a Bayesian estimate which is the same in all four methods.

Methods	Expected $p$	Expected $p$ in Example 2
Belief functions	$[\frac{x}{n+1}, \frac{x+1}{n+1}]$	[0.1875,0.2500]
LME (Maximum Likelihood Estimate)	$\frac{x}{n}$	0.2
Laplace	$\frac{x+1}{n+2}$	0.2353
Jeffers	$\frac{x+1/2}{n+1}$	0.2059

TABLE II: Expected  $p$  according to different methods

V. A COMBINED APPROACH BASED ON ENs AND FT ANALYSIS

A. Introduction

Within the context of this paper, we use the definition of human errors given by Swain and Guttman [SG83]: *An error is an out of tolerance action, where the limits of tolerable performance are defined by the system.* The human error is then considered as a deviation from expected performance (signal passed at danger (SPAD) incidents, over speeding, etc.) and this deviation is defined by the consequence (immediate dangerous situation or accident).

Due to its capability in modeling the systems, ENs have been combined with FT analysis method to determine the belief occurrence of the railway accident. The proposed approach consists of five steps:

- 1) Constructing a Cause Effect diagram. At this stage we identify the principal causes and their sub-causes.
- 2) Constructing ENs for only principal causes which have sub-causes. At this stage the relations between the principal causes and their sub-causes found at the previous step are translated into ENs.
- 3) Belief propagation (marginalization and combination operations). At this stage we propagate the prior BBAs of sub-causes and the conditional BBAs representing the relations between principal causes and their sub-causes through the network and compute the marginal BBAs of principal causes.
- 4) Constructing a FT which has top event (e.g. the railway accident) and basic events represented by principal causes.
- 5) Using generalized expressions of belief and plausibility measures to evaluate the top event belief occurrence from the marginal BBAs of principal causes computed using belief propagation.

B. Construction of Cause Effect diagram

In order to identify, sort, and display possible causes of the railway accident we use the Cause Effect diagram method which graphically illustrates the relationship between a given outcome and all the factors that influence the outcome. This type of diagram is sometimes called an "Ishikawa diagram" because it was invented by Kaoru



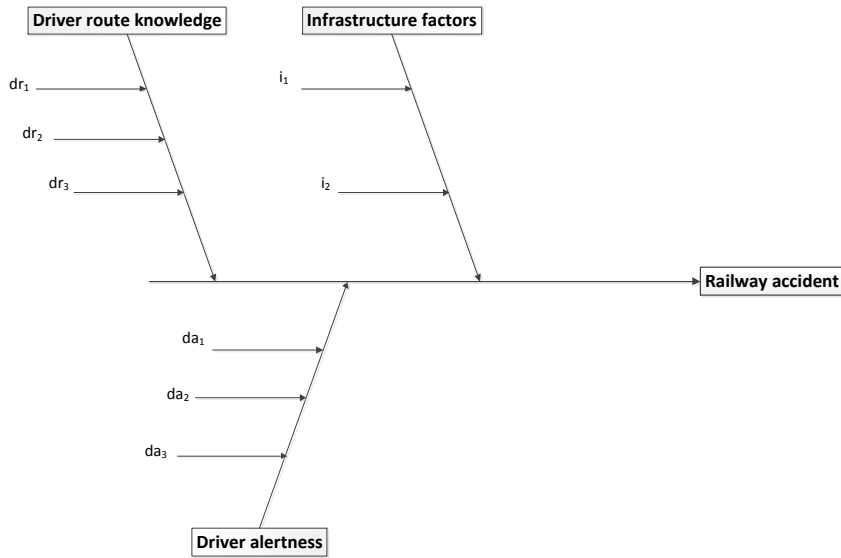

Fig. 3: Cause Effect diagram for the example

Ishikawa [Ish76], or a "fishbone diagram" because of the way it looks. The diagram's structure includes a central "bone" with the topic of interest attached at the right-hand end. Branching out from the central line are "sub-bones" that represent primary causal factors, and each of these in turn has sub-bones representing subsidiary contributing factors.

For example consider a railway accident where the driver passes the signal at danger. The driver have mistakenly read the signal aspect for an adjacent line. The investigations concluded that the driver read an adjacent signal that was displaying a single yellow cautionary aspect due to three principal causes: driver route knowledge, infrastructure factors and driver alertness. Three sub-causes  $dr_1$ ,  $dr_2$  and  $dr_3$  were associated with the driver route knowledge, two sub-causes  $i_1$  and  $i_2$  were associated with the infrastructure factors, and three sub-causes  $da_1$ ,  $da_2$  and  $da_3$  were associated with the driver alertness. The Cause Effect diagram of this example is presented in Figure 3.

C. Construction of Evidential Network

The relations between each principal cause and its sub-causes are represented by an EN. The task consists on computing the marginal beliefs for the principal causes. The models of principal causes are shown in the form of ENs, where the variables are represented by circular nodes and the BBAs valuations by diamond shapes. Each valuation node is connected by edges to the subset of variables which define its domain. For example, let us consider the principal cause "Driver route knowledge" represented by the variable  $D$ , the valuations  $m_4^{\Omega_{dr1}}$ ,  $m_5^{\Omega_{dr2}}$ , and  $m_6^{\Omega_{dr3}}$  represent the prior BBAs of the variables  $dr_1$ ,  $dr_2$  and  $dr_3$ . The remaining conditional BBAs  $m_1^{\Omega_D \times \Omega_{dr1}}$ ,

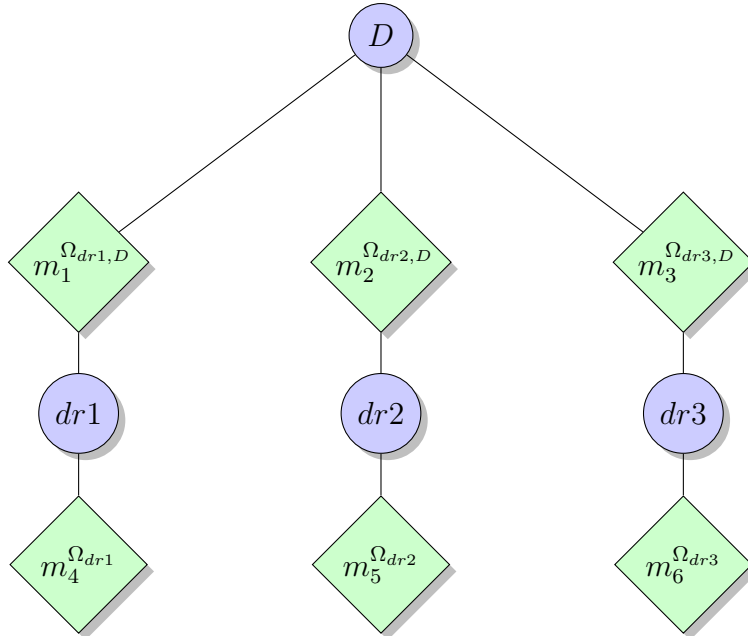

Fig. 4: EN for Driver route knowledge

$m_2^{\Omega_D \times \Omega_{dr2}}$ , and  $m_3^{\Omega_D \times \Omega_{dr3}}$  represent the relations between the variable  $D$  and the variables  $dr_1$ ,  $dr_2$  and  $dr_3$  (cf. Figure 4). In this paper, due to insufficiency data, we use expert opinions to define the conditional and prior BBAs. Then we use marginalization and Dempster combination to obtain BBAs of principal causes.

#### D. Combined FT with ENs

A FT represents how combinations of basic events lead to the occurrence of the undesired event (top event). In this work, the principal causes are the basic events (cf. Figure 5) of the FT and we aim to compute the belief occurrence of top event using the BBAs of principal causes computed using the ENs.

Based on our previous works proposed in [SSA10], [ASS11], we can compute the interval belief of top event occurrence using the BBAs of basic events and the minimal cut sets of the FT. Let us consider that for each basic event  $e_i$ , the state of belief on its occurrence is bounded by  $[Bel(\{e_i\}), Pl(\{e_i\})]$  defined over  $\Omega_{e_i} = \{e_i, \bar{e}_i\}$  where  $e_i$  and  $\bar{e}_i$  denote respectively the occurrence and the absence of event  $e_i$ . The belief occurrence of the undesired event is obtained using Eqs. 30 and the following notation:

$N_C$  Number of minimal cuts in the FT.

$C_i$  Index set of the  $i_{th}$  minimal cut set.

$$\begin{aligned}
 Bel(\{e_{top}\}) &= \prod_{i=1}^{N_C} \left( 1 - \prod_{j=1}^{size(C_i)} \left( 1 - m^{\Omega_{e_{C_i(j)}}}(e_{C_i(j)}) \right) \right) \\
 Pl(\{e_{top}\}) &= \prod_{i=1}^{N_C} \left( 1 - \prod_{j=1}^{size(C_i)} m^{\Omega_{e_{C_i(j)}}}(\bar{e}_{C_i(j)}) \right)
 \end{aligned} \tag{30}$$

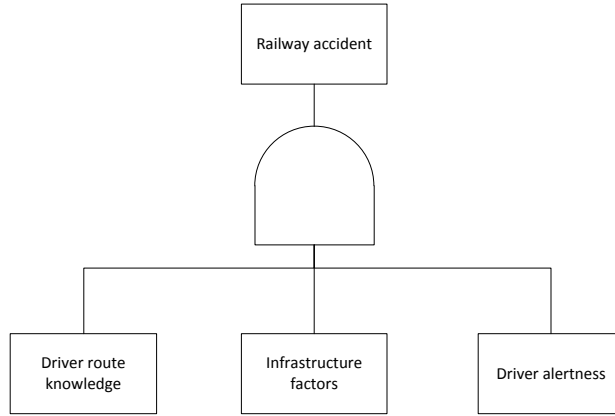

Fig. 5: Fault Tree of railway accident

Where  $size(C_i)$  denotes the number of basic events in the minimal cut set  $C_i$ . Therefore, the belief occurrence of the top undesired event is bounded by the interval  $[Bel(\{e_{top}\}), Pl(\{e_{top}\})]$ . In the previous example when the driver passes the signal at danger, we have three minimal cut sets:

- $C_1$ : Driver route knowledge.
- $C_2$ : Infrastructure factors.
- $C_3$ : Driver alertness.

The belief and plausibility measures are obtained as follows:

$$Bel(\{e_{top}\}) = m^{\Omega_{e_{C_1}}}(\{e_{C_1}\})m^{\Omega_{e_{C_2}}}(\{e_{C_2}\})m^{\Omega_{e_{C_3}}}(\{e_{C_3}\})$$

$$Pl(\{e_{top}\}) = (1 - m^{\Omega_{e_{C_1}}}(\{\bar{e}_{C_1}\}))(1 - m^{\Omega_{e_{C_2}}}(\{\bar{e}_{C_2}\}))(1 - m^{\Omega_{e_{C_3}}}(\{\bar{e}_{C_3}\}))$$

In some cases, risk engineers need to convert the interval beliefs of top event occurrences to a probability measures. Such a transformation is called a probabilistic transformation. We define the probabilistic transformation as a mapping  $f : m \rightarrow P$  where  $P$  denotes the probability distribution and  $m$  the BBA function [Dan05]. A probabilistic transformation  $f$  is:

- *ulb*-consistent (upper and lower bound consistent): if  $Bel(A) \leq f(A) \leq Pl(A)$  for any  $A \subseteq \Omega$ .
- *p*-consistent (or probabilistically consistent): if  $f(m) = m$  for any Bayesian BBA  $m$ .
- $\alpha$ -consistent: if  $f(\alpha m_1 + (1 - \alpha)m_2) = \alpha f(m_1) + (1 - \alpha)f(m_2)$  for any BBAs  $m_1$  and  $m_2$ .

The most known probabilistic transformation is the pignistic transformation  $BetP$ . It was introduced by Smets

and Kennes [SK94] and corresponds to the generalized insufficient reason principle: a BBA assigned to the union of  $n$  atomic sets is split equally among these  $n$  sets. The pignistic transformation  $BetP$  is the only one which has the three properties:  $\alpha$ -consistency,  $p$ -consistency and  $ulb$ -consistency. It is defined for any set  $B \subseteq \Omega$  and  $B \neq \emptyset$  by the following:

$$BetP(B) = \sum_{A \neq \emptyset | A \subseteq \Omega} \frac{|A \cap B|}{|A|} \frac{m(A)}{1 - m(\emptyset)} \quad (31)$$

Where  $|A|$  denotes the cardinality of  $A \subseteq \Omega$ . In the case of FT analysis and closed world hypothesis (*i.e.*  $m(\emptyset) = 0$ ), the pignistic top event occurrence  $BetP(\{e_{top}\})$  is given by:

$$BetP(\{e_{top}\}) = m^{\Omega_{e_{top}}}(\{e_{top}\}) + \frac{m^{\Omega_{e_{top}}}(\{e_{top}, \bar{e}_{top}\})}{2} \quad (32)$$

It should be noted that other probabilistic transformations were also defined using different kinds of mappings either proportional to the plausibility, to the normalized plausibility, to all plausibilities, to the belief or a hybrid mapping [J. 06].

## VI. CASE STUDY

### A. Description of situation

This section presents a case study that illustrates the main principles of our methodology. The model is based on a situation on which there was a near head-to-head encounter between two trains. The event took place early in the morning after some maintenance works performed during the night-shift. The idea here is to study how several organizational, technical and human factors influenced the occurrence of this situation, *i.e.*, we want to measure the risk of a head-to-head encounter given the surrounding conditions of the scenario. In a way, it can be seen as a sensitivity analysis of how the different factors (and its epistemic uncertainty) could have affected the occurrence (risk) of the head-to-head encounter. Although it is an hypothetical situation, it was inspired by the analysis of several reports of real case studies done by the BEATT (“Bureau d’Enquêtes sur les Accidents de Transport Terrestre” French land transport accident investigation bureau).

The scenario takes place in a railway section between three stations  $A$ ,  $B$  and  $C$  (cf. Figure 6). Some maintenance works were scheduled on one side of the railway track heading west (Head 2). To allow the traffic to continue, all passing trains heading in this direction were redirected to the other track in the opposite direction (Head 1). In these kind of situations, protective measures are installed to avoid a potential accident. Moreover, the circulation agenda of the commercial trains is slightly modified. The works extended over 10 km, they took place over the night and were programmed to end early in the morning in order to avoid unnecessary delays in the commercial trains. The maintenance involved two trains (named engineering trains  $TTX1$  and  $TTX2$ ). The works were supervised by a *foreman* and the movement of the trains was controlled by a *traffic agent*.

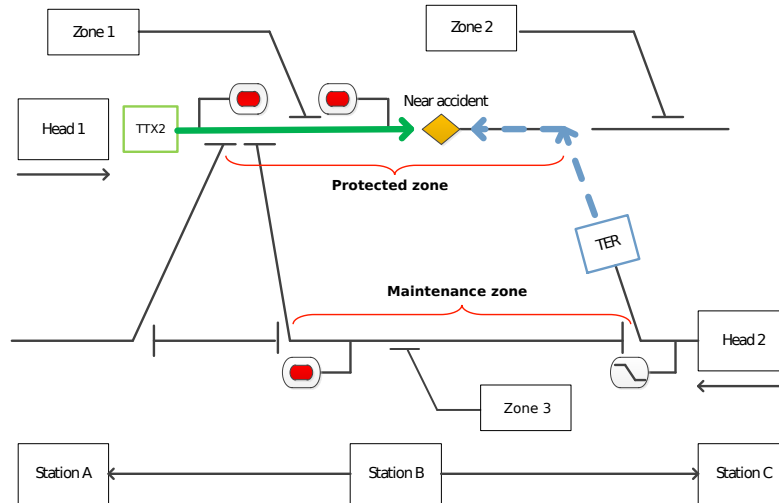

Fig. 6: Description of the scenario some moments before the near accident

Early in the morning, when the engineering trains were performing the final maneuvers to clear the tracks, the train *TTX2* encountered head to head with a commercial train *TER* going in the opposite direction. The near accident was caused by a series of unexpected events. To start with, train *TTX2* was initially planned to park in a zone near station C as soon as the maintenance works were finished. A delay on the works forced to change the initial parking position of train *TTX2* so as to avoid unnecessary disturbances of the early morning commercial trains. When the proposed changes were going to be implemented, the *foreman* realized that the access to the newly reserved parking position (Zone 3) for train *TTX2* was blocked by train *TTX1*, therefore, he was rushed into a second change of parking positions under complicated measures. Badly advised by the *traffic agent*, he chose to park the train in Zone 2 in a manner that forced it to pass by a protected zone running in an opposite direction (the place of the near accident). When the train *TTX2* was going to engage the protected zone, he encountered a closed signal that forbade him from crossing. The driver of the train called the *traffic agent* who decided to grant him the permission to cross the closed signal without taking into account the early morning time table of the commercial trains. As a consequence of these series of events, the near accident happened (cf. Figure 6).

After a deep analysis of the circumstances, four basic events are identified as the precursors of the near accident, namely:

- **Bad change of parking plans :** The decision to change the parking plans of the engineering train *TTX2* was taken by the *foreman* thanks to several factors. To start with, the planning was delayed at the beginning putting some extra pressure to finish the work on time. Moreover, the *traffic agent* validated the change of plans with a lack of knowledge of the different parking positions of the train station and their state of occupancy. In addition,

the *foreman* was in a very noisy environment when he took the decision. Finally, there was over-familiarity between the *foreman* and the *traffic agent*.

- **Crossing permission of closed signal :** The *traffic agent* granted the permission to cross the closed signal to the train driver because he had the illusion of a “safe” situation. Indeed, as all of the signals in the working area were closed, he thought that there was no danger. He forgot that the signals were all closed on the moment that a train entered the protected area running in the opposite direction. He maybe was not aware about the reduced overlap between signals. As a consequence, he did not take into account the time table of the commercial trains and did not realized that a train was heading in the direction of the accident. This situation is considered a consequence of the lack of experience of the *traffic agent* or due to a poor *traffic agent* interface design. He also based his decision on the fact that others had already granted the permission to cross the same signals. He thought, “*Somebody already verified the situation, it should work this time*”.
- **Blocked road :** The train *TTX1* was blocking the way of train *TTX2*, causing more delays on the parking maneuvers. The way the initial plan was stated, this situation should not have happened because the parking track of the trains headed in an opposite direction.
- **Reduction of speed at time:** Finally, the *traffic agent* could not ask the driver of the train to reduce speed at time due to a system communication failure.

### B. The near accident model

The four basic events identified are considered as the principal causes of the near accident. Two of them are considered as technical, the *blocked road* and the *Reduction of speed at time* and the two others are considered as events influenced by human and organizational factors as indicated in the following descriptions:

#### 1) Bad change of parking plans (*BR*)

- Noisy environment: The *foreman* had to take the decision in a noisy environment which made the communication with the *traffic agent* complicated and created a harsh work environment.
- *Traffic agent* confirmation: The *traffic agent* confirmed that the new plan was feasible, but complicated. In reality it was not, but the *foreman* trusted in his opinion.
- Delay on works: Several delays at the beginning and during the work forced the traffic agent to change the plans.
- Over-familiarity between the *foreman* and the *traffic agent*.

#### 2) Crossing permission of closed signal (*CR*)

- Pre-existing confirmations: The *traffic agent* based his decision on the fact that others had already granted the permission to cross the same signals. He thought, “*Somebody already verified the situation, it should*

TABLE III: List of variables of the near accident model

Variable	Description
NA	Near Accident
BD	Bad change of parking plans
NE	Noisy environment
PT	Poor <i>traffic agent</i> interface design
TC	<i>Traffic agent</i> confirmation
DW	Delay on works
OF	Over-familiarity between the <i>foreman</i> and <i>traffic agent</i>
CR	Crossing permission of closed signal
PC	Pre-existing confirmations
TR	The <i>traffic agent</i> did not know the reduced overlap between signals
AT	Agent on training
RS	Reduction of speed at time
BR	Blocked road

*work this time*".

- The *traffic agent* did not know of the reduced overlap between signals.
- Poor *traffic agent* interface design.
- *Traffic agent* on training: He was also in the final phase of a training period.

3) Reduction of speed at time. (*RS*)

4) Blocked road. (*BR*)

The Near Accident (*NA*) is illustrated with the cause effect diagram presented in Figure 7 and the fault tree presented in Figure 8. A list of the variables with their descriptions is given in Table III. As shown in the cause effect diagram, variables *CR* and *BD* were associated with four sub-causes each, i.e., factors that influenced the outcome of variables. On the other hand, variables *RS* and *BR* represent principal causes without sub-causes. From the fault tree it can be seen that the four principal causes are related to the variable *NA* by an *AND* gate. The next task consists of constructing ENs for variables *CR* and *BD* relating them with their respective factors  $\{PC, TR, AT, PT\}$  and  $\{NE, TC, DW, OF\}$ . The two ENs will allow us to compute marginal BBAs of the variables *BD* and *CR* by using prior and conditional BBAs given by experts. The variables *RS* and *BR* do not depend on other factors, thus, their BBAs are directly given by experts. The ENs of variables *BD* and *CR* are shown in Figures 9 and 10 respectively. In the EN representing the variable *BD*, the valuations  $m_5^{\Omega_{NE}}$ ,  $m_6^{\Omega_{TC}}$ ,  $m_7^{\Omega_{DW}}$  and  $m_8^{\Omega_{OF}}$  represent respectively the prior BBAs given by experts for the variables *NE*, *TC*, *DW* and *OF*. The BBAs  $m_1^{\Omega_{BD} \times \Omega_{NE}}$ ,  $m_2^{\Omega_{BD} \times \Omega_{TC}}$ ,  $m_3^{\Omega_{BD} \times \Omega_{DW}}$  and  $m_4^{\Omega_{BD} \times \Omega_{OF}}$  represent respectively the relations between

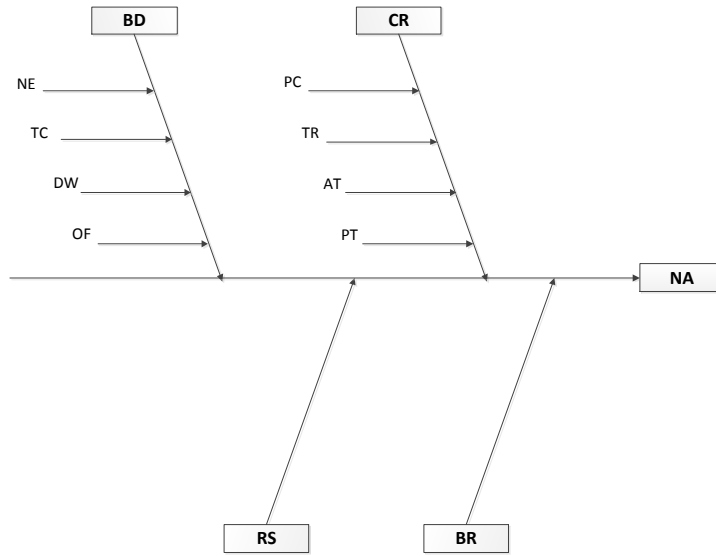

Fig. 7: Cause Effect Diagram of the near accident

the variable  $BD$  and the variables  $NE$ ,  $TC$ ,  $DW$ , and  $OF$  obtained from conditional BBAs given by experts. For example, according to Table IV which presents conditional and prior BBAs for the different factors, we have  $m^{\Omega_{BD}}(\{BD\}|\{NE\}) = 0.02$ , this will be represented by the following BBAs:

$$m_1^{\Omega_{BD} \times \Omega_{NE}}(\{(BD, NE), (BD, \overline{NE}), (\overline{BD}, \overline{NE})\}) = 0.02$$

$$m_1^{\Omega_{BD} \times \Omega_{NE}}(\{\Omega_{BD} \times \Omega_{NE}\}) = 0.98$$

where  $\Omega_{BD} = \{BD, \overline{BD}\}$  and  $\Omega_{NE} = \{NE, \overline{NE}\}$ .

### C. Quantitative analysis of the near accident

First, Dempster combination rule is used to obtain the joint BBAs of the two ENs. Then marginalization operation is used to obtain the marginal BBAs of the variables  $BD$  and  $CR$ . Finally, using BBAs of basic events of the FT ( $BD$ ,  $CR$ ,  $RS$  and  $BR$ ) the top event belief occurrence (the occurrence of  $NA$ ) is computed using formula given in Eq. 30 and the pignistic values are computed using Eq. 32.

First, we consider that the experts give only conditional BBAs and they have no knowledge about the prior BBAs



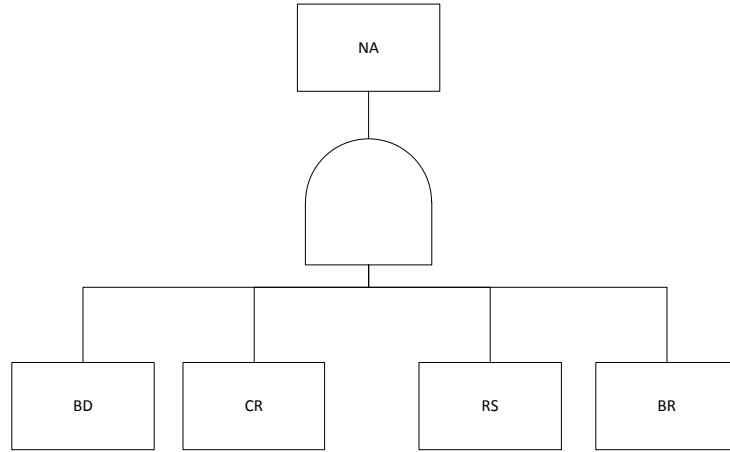

Fig. 8: Fault Tree of the near accident

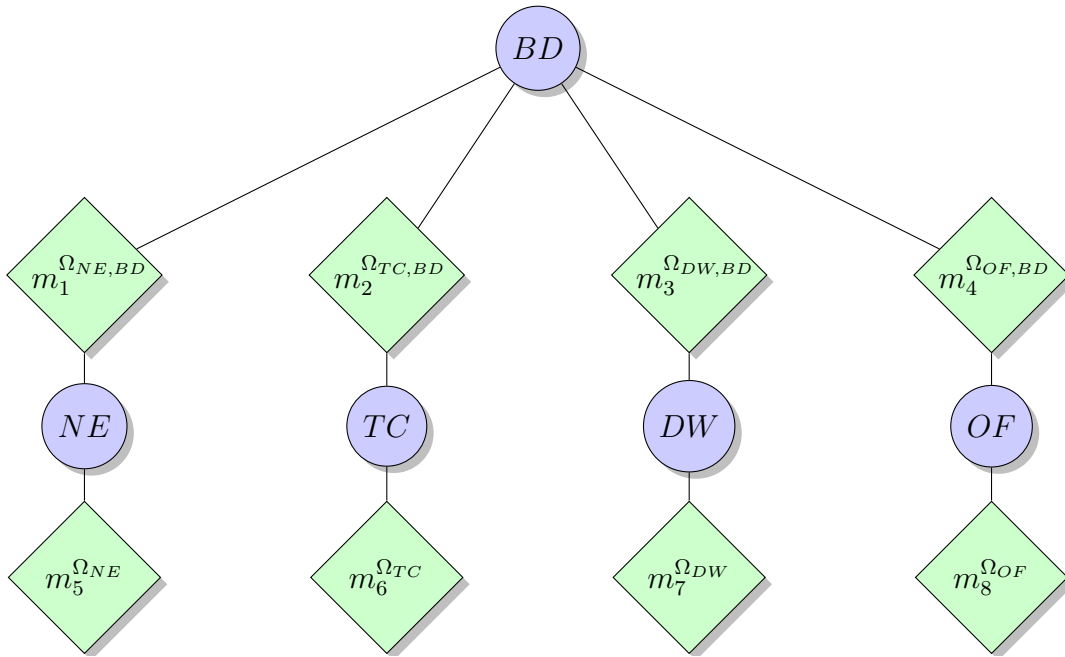

Fig. 9: EN for Bad change of parking plans

of the variables. We represent this situation by vacuous BBAs (cf. Table IV):

$$\begin{aligned}
 m^{\Omega_{\theta_i}}(\{\theta_i\}) &= 0 \\
 m^{\Omega_{\theta_i}}(\{\bar{\theta}_i\}) &= 0 \\
 m^{\Omega_{\theta_i}}(\{\theta_i, \bar{\theta}_i\}) &= 1, \quad \theta_i \in \{NE, DW, OF, PC, TR, AT, PT\}
 \end{aligned}$$

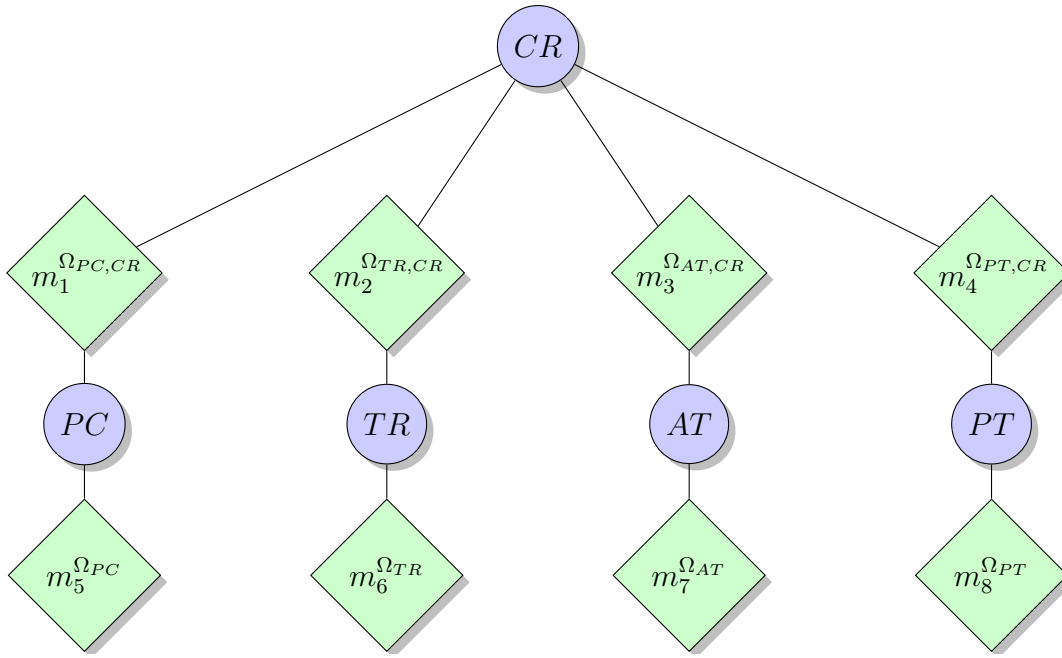

Fig. 10: EN for Crossing Permission

TABLE IV: Conditional and prior BBAs for the different factors

Human error $e_i$	$\theta_i$	Conditional BBAs		Prior BBAs	
		$m^{\Omega_{e_i}}(\{e_i\} \{\theta_i\})$	$m^{\Omega_{\theta_i}}(\{\theta_i\})$	$m^{\Omega_{\theta_i}}(\{\bar{\theta}_i\})$	$m^{\Omega_{\theta_i}}(\{\theta_i, \bar{\theta}_i\})$
BD	NE	0.02	0	0	1
	TC	0.5	0	0	1
	DW	0.04	0	0	1
	OF	0.15	0	0	1
CR	PC	0.1	0	0	1
	TR	0.05	0	0	1
	AT	0.2	0	0	1
	PT	0.05	0	0	1

According to Table V, in the case of no prior belief about BBAs of factors (Initial information), the risk of accident is bounded by  $[0, 0.06]$ . The pignistic value of the risk of accident occurrence is 0.03 (cf. Table VI). Now suppose that  $m^{\Omega_{DW}}(\{DW\}) = 0.3$ ,  $m^{\Omega_{DW}}(\{\overline{DW}\}) = 0.2$  and  $m^{\Omega_{DW}}(\{DW, \overline{DW}\}) = 0.5$  (Information 1). This is equivalent to the fact that degree of occurrence of the event  $DW$  is  $[0.3, 0.8]$ . The risk of accident is then bounded by  $[0, 0.042]$ . Let us suppose the fact that we are certain that the traffic agent interface design was poor and there is a delay on work (Information 2). This will be represented by:

$$m^{\Omega_{TC}}(\{TC\}) = 1; m^{\Omega_{DW}}(\{DW\}) = 1$$

The risk of accident is then bounded by  $[0.00005, 0.06]$ . As we can see the belief over the occurrence of the near

TABLE V: The obtained beliefs and plausibility measures after receiving informations

$\theta_i$	Initial Situation		Information 1		Information 2		Information 3	
	$Bel(\{\theta_i\})$	$Pl(\{\theta_i\})$	$Bel(\{\theta_i\})$	$Pl(\{\theta_i\})$	$Bel(\{\theta_i\})$	$Pl(\{\theta_i\})$	$Bel(\{\theta_i\})$	$Pl(\{\theta_i\})$
BD	0	1	0.008	0.7	0.04	1	0.6	1
CR	0	1	0	1	0.05	1	0.3502	1
BR	0.5	0.6	0.5	0.6	0.5	0.6	0.5	0.6
RS	0.05	0.1	0.05	0.1	0.05	0.1	0.05	0.1
Near accident	0	0.06	0	0.042	0.00005	0.06	0.00525	0.06

TABLE VI: The Pignistic values after receiving informations

$\theta_i$	Initial Situation	Information 1	Information 2	Information 3
	$BetP(\{\theta_i\})$	$BetP(\{\theta_i\})$	$BetP(\{\theta_i\})$	$BetP(\{\theta_i\})$
BD	0.5	0.35	0.52	0.8
CR	0.5	0.5	0.55	0.6751
BR	0.55	0.55	0.525	0.55
RS	0.075	0.075	0.075	0.075
Near accident	0.03	0.021	0.0	0.0326

accident is increased because it depends significantly on the events  $DW$  and  $TC$ .

Finally suppose the fact that we are certain of the occurrence of all factors (Information 3). This will be represented by:

$$m^{\Omega_{NE}}(\{NE\}) = 1$$

$$m^{\Omega_{OF}}(\{OF\}) = 1$$

$$m^{\Omega_{PC}}(\{PC\}) = 1$$

$$m^{\Omega_{TR}}(\{TR\}) = 1$$

$$m^{\Omega_{AT}}(\{AT\}) = 1$$

$$m^{\Omega_{AT}}(\{PT\}) = 1$$

The risk of accident is then bounded by  $[0.00525, 0.06000]$ . The pignistic value of the risk of accident occurrence is 0.0326 (cf. Table VI). As we can expect, the belief and pignistic values of the near accident occurrence have increased.

In this probabilistic approach, we use Monte-Carlo sampling simulations to repeatedly sample component failure probabilities from the appropriate distributions, and to calculate and record the system's reliabilities. We choose

TABLE VII: Comparison between belief functions and probabilistic approaches

	Initial Situation	Information 1	Information 2	Information 3
Belief functions	[0, 0.06000]	[0, 0.04200]	[0.00005, 0.06000]	[0.0052, 0.06000]
MC simulation (Uniform distribution)	[0.00005, 0.03933]	[0.00005, 0.0390]	[0.00041, 0.04007]	[0.00835, 0.04511]
MC simulation (Normal distribution)	[0.00103, 0.02509]	[0.00119, 0.0259]	[0.00194, 0.02576]	[0.01241, 0.03451]

uniform and normal distribution for the probabilities of events occurrence. The confidence interval of the probabilistic approach is 99%. Table VII presents the results computed by the belief functions and by probabilistic approaches. It shows that the differences between results obtained using these two different approaches are very small. However, the width of the support defined by the belief functions approach is higher than the width of the support in the probabilistic approach because the belief approach is more conservative. By assuming a uniform and a normal distributions for probabilities of events occurrence, we introduce more uncertainty into the probabilistic approach and the results depends on the chosen law which is not the case in the belief function approach.

## VII. CONCLUSIONS

This paper presents a first attempt to account for human factors in risk analysis using belief functions theory. The ENs operations are used to elicit the masses of the basic events when they are influenced by several factors and finally, the belief over the basic events is propagated to the top undesired event.

The advantage of the presented method is that our state of belief about the conditional relationship between the different factors and the basic beliefs does not have to be perfect. Indeed, the method is well suited to account for ignorance and a priori knowledge about the basic events are not needed.

Another advantage is that the method is capable of taking into account human, organizational and technical factors in the risk analysis of railway systems.

## REFERENCES

- [AH12] Eirik Albrechtsen and P. Hokstad. Conditioning in Dempster-Shafer theory: prediction vs. revision, Belief functions: theory and applications. Proc. of the 2nd Int. Conf. on Belief Functions, Springer, AISC 164. pages 385–392, 2012.
- [Alm95] R G Almond. *Graphical belief modeling*. Chapman and Hall, 1995.
- [AN10] T Aven and T E Nokland. On the use of uncertainty importance measures in reliability and risk analysis. *Reliability Engineering & System Safety*, 95:127–133, 2010.
- [Apo90] G. Apostolakis. The concept of probability in safety assessments of technological systems. *Science*, 250:1359–1364, 1990.
- [ASS11] Felipe Aguirre, Mohamed Sallak, and Walter Schön. Generalized expressions of reliability of series-parallel and parallel-series systems using the Transferable Belief Model. In Christophe Berenguer, Antoine Grall, and C Guedes Soares, editors, *Advances in Safety, Reliability and Risk Management*, page 344, Troyes, France, 2011. Taylor & Francis Group.
- [Ave11] T Aven. Interpretations of alternative uncertainty representations in a reliability and risk analysis context. *Reliability Engineering & System Safety*, 96:353–360, 2011.

- [BCFR08] Alessio Benavoli, Luigi Chisci, Alfonso Farina, and Branko Ristic. Modelling Uncertain Implication Rules in Evidence Theory. In *Information Fusion, 2008 11th International Conference on*, pages 1–7, Cologne, 2008.
- [BCMWO9] M. T. Baysari, C. Caponecchia, A. S. McIntosh, and J. R. Wilson. Classification of errors contributing to rail incidents and accidents: A comparison of two human error identification techniques. *Safety Science*, 47:948–957, 2009.
- [BDG06] C. Baudrit, D. Dubois, and D. Guyonnet. Joint propagation and exploitation of probabilistic and possibilistic information in risk assessment. *IEEE Transactions on Fuzzy Systems*, 14:593–608, 2006.
- [BFB<sup>+</sup>10] Ronald L. Boring, John A Forester, Andreas Bye, Vinh N. Dang, and Erasmia Lois. Lessons Learned on Benchmarking from the International Human Reliability Analysis Empirical Study. Technical report, Idaho National Laboratory, June 2010.
- [BGC04] H R Bae, R V Grandhi, and R A Canfield. An approximation approach for uncertainty quantification using evidence theory. *Reliability Engineering & System Safety*, 86:215–225, 2004.
- [BH09] Julie Bell and Justin Holroyd. Review of human reliability assessment methods. Technical report, Health and Safety Executive, Buxton, Derbyshire, UK, 2009.
- [BMW08] Melissa T Baysari, Andrew S McIntosh, and John R Wilson. Understanding the human factors contribution to railway accidents and incidents in Australia. *Accident; analysis and prevention*, 40(5):1750–7, September 2008.
- [BSHC11] F Belmonte, W Schön, L Heurley, and R Capel. Interdisciplinary safety analysis of complex socio-technological systems based on the Functional Resonance Accident Model: An application to railway traffic supervision. *Reliability Engineering & System Safety*, 96:237–249, 2011.
- [CAZ91] Sergio Contini, Aniello Amendola, and I. Ziomas. Benchmark Exercise on Major Hazard Analysis. Vol. 1. Description of the Project, Discussion of the Results and Conclusions. Technical report, Joint Research Center - ISPRA Site, 1991.
- [Cor96] P. Cornell. Uncertainties in risk analysis: six levels of treatment. *Reliability Engineering & System Safety*, 54:95–111, 1996.
- [Dan05] Milan Daniel. Probabilistic Transformations of Belief Functions. pages 539–551, 2005.
- [Dem67] A P Dempster. Upper and lower probabilities induced by a multivalued mapping. *Annals of Mathematical Statistics*, 38:325–339, 1967.
- [DK88] A Dempster and A Kong. Uncertain evidence and artificial analysis. *Journal of Statistical Planning and Inference*, 20:355–368, 1988.
- [Fin74] B. De Finetti. *Theory of Probability*. New York: Wiley & Sons., 1974.
- [GF99] G. J. Klir and T A Folger. *Fuzzy Sets, Uncertainty and Information*. Englewood Cliffs. Prentice-Hall., 1999.
- [Gut91] M A S Guth. A probabilistic foundation for vagueness and imprecision in fault tree analysis. *IEEE Transactions on Reliability*, 40:563–571, 1991.
- [HAH10] Jan Hovden, Eirik Albrechtsen, and Ivonne A Herrera. Is there a need for new theories, models and approaches to occupational accident prevention? *Safety Science*, 48(8):950–956, 2010.
- [HJOS07] J.C. Helton, J.D. Johnson, W.L. Oberkampf, and C.B. Storlie. A sampling-based computational strategy for the representation of epistemic uncertainty in model predictions with evidence theory. *Computer Methods in Applied Mechanics and Engineering*, 196:37–40, 2007.
- [Hol93] Erik Hollnagel. *Human reliability analysis: Context and control*. Academic Press London, 1993.
- [Ina91] T Inagaki. Independence between safety-control policy and multiple-sensors schemes via Dempster-Schafer theory. *IEEE Transactions on Reliability*, 40:182–188, 1991.
- [Ish76] Kaoru Ishikawa. *Guide to Quality Control*. Tokyo: Asian Productivity Organization, 1976.
- [J. 06] J. Sudano. Yet Another Paradigm Illustrating Evidence Fusion (YAPIEF). In *Proc. of Fusion 2006, Florence, Italy*, 2006.
- [KA96] S. T. Knaggs and M. D. Aberd. Human reliability and its relation to accidents by railway and on sea. *Human reliability*, pages 879–880, 1896.

- [KBY10] Dong San Kim, Dong Hyun Baek, and Wan Chul Yoon. Development and evaluation of a computer-aided system for analyzing human error in railway operations. *Reliability Engineering & System Safety*, 95(2):87–98, February 2010.
- [KG81] S. Kaplan and B.J. Garrick. On the quantitative definition of risk. *Risk Analysis*, 1:11–27, 1981.
- [Kir90] Barry Kirwan. A resources flexible approach to human reliability assessment for PRA. In *Safety and Reliability Symposium*, pages 114–135, Altrincham, UK, 1990. Elsevier Inc.
- [Kir96] Barry Kirwan. The validation of three human reliability quantification techniques THERP, HEART and JHEDI: Part I technique descriptions and validation issues. *Applied Ergonomics*, 27(6):359–373, 1996.
- [Kir97] Barry Kirwan. The validation of three human reliability quantification techniques THERP, HEART and JHEDI: part III Practical aspects of the usage of the techniques. *Applied Ergonomics*, 28(1):27–39, 1997.
- [KKTAL97] Barry Kirwan, Richard Kennedy, Sally Taylor-Adams, and Barry Lambert. The validation of three Human Reliability Quantification techniques THERP, HEART and JHEDI: Part II Results of validation exercise. *Applied Ergonomics*, 28(1):17–25, 1997.
- [KNKM06a] Myrto Konstandinidou, Zoe Nivolianitou, Chris Kiranoudis, and Nikolaos Markatos. A fuzzy modeling application of CREAM methodology for human reliability analysis. *Reliability Engineering & System Safety*, 91(6):706–716, June 2006.
- [KNKM06b] M. Konstandinidou, Z. Nivolianitoub, C. Kiranoudisa, and N. Markatosa. A fuzzy modeling application of cream methodology for human reliability analysis. *Reliability Engineering & System Safety*, 91:706–716, 2006.
- [Lap51] P. S. Laplace. *A Philosophical Essay on Probabilities*. New York: Dover Publications Inc., 1814, English edition 1951.
- [LS07] P Limbourg and R Savi. *Fault tree analysis in an early design stage using the Dempster-Shafer theory of evidence*. Risk, Reliability and Societal Safety-Aven and vinnem, Taylor & Francis Group, 2007.
- [OHJ<sup>+</sup>04] W L Oberkamp, J C Helton, C A Joslyn, S F Wojtkiewicz, and S Ferson. Challenge problems: uncertainty in system response given uncertain parameters. *Reliability Engineering & System Safety*, 85:11–19, 2004.
- [PS08] Saeid Pashazadeh and Mohsen Sharifi. Reliability Assessment under Uncertainty Using Dempster-Shafer and Vague Set Theories. *Science And Technology*, (July):14–16, 2008.
- [Rea90] James Reason. *Human Error*. Cambridge University Press, 1990.
- [SG83] A D Swain and H E Guttman. Handbook of human-reliability analysis with emphasis on nuclear power plant applications. Final report. Technical report, Sandia National Labs., Albuquerque, NM (USA), 1983.
- [Sha76] G Shafer. *A Mathematical Theory of Evidence*. Princeton University Press, 1976.
- [She89] P. P. Shenoy. A valuation-based language for expert systems. *International Journal of Approximate Reasoning*, 3:383–411, 1989.
- [Sim08] Christophe Simon. Bayesian networks inference algorithm to implement Dempster Shafer theory in reliability analysis. *Reliability Engineering & System Safety*, 93(7):950–963, 2008.
- [SK94] P Smets and R Kennes. The Transferable Belief Model. *Artificial Intelligence*, 66:191–243, 1994.
- [Sme90] P Smets. The combination of evidence in the Transferable Belief Model. *IEEE Transactions on Pattern Analysis and Machine Intelligence*, 12:447–458, 1990.
- [Sme93] Philippe Smets. Belief functions: The disjunctive rule of combination and the generalized Bayesian theorem. *International Journal of Approximate Reasoning*, 9(1):1–35, 1993.
- [SSA10] Mohamed Sallak, Walter Schön, and Felipe Aguirre. Transferable belief model for reliability analysis of systems with data uncertainties and failure dependencies. *Proceedings of the Institution of Mechanical Engineers, Part O: Journal of Risk and Reliability*, 224(4):266–278, 2010.
- [SW09] C Simon and P Weber. Evidential networks for reliability analysis and performance evaluation of systems with imprecise knowledge. *IEEE Transactions on Reliability*, 58:69–87, 2009.

- [TF03] W. T. Tucker and S. Ferson. Probability bounds analysis in environmental risk assessments. *Applied Biomathematics, Setauket, NY*, 2003.
- [UG08] U. K. Rakowsky and U Gocht. Reasoning in reliability centred maintenance based on a Dempster-Shafer approach. *Proceedings of the Institution of Mechanical Engineers, Part O: Journal of Risk and Reliability*, 222:605–612, 2008.
- [Van99] F Vanderhaegen. APRECIH: a human unreliability analysis method application to railway system. *Control Engineering Practice*, 7(11):1395–1403, November 1999.
- [Van01] Frédéric Vanderhaegen. A non-probabilistic prospective and retrospective human reliability analysis method application to railway system. *Reliability Engineering & System Safety*, 71(1):1–13, 2001.
- [Ven66] J. Venn. *The Logic of Chance*. 1866.
- [Was90] L. A. Wasserman. Prior envelopes based on belief functions. *The Annals of Statistics*, 18:454–464, 1990.
- [Wil86] J C Williams. HEART, a proposed method for assessing and reducing human error. 1986.