



**HAL**  
open science

## **Radio wave propagation in curved rectangular tunnels at 5.8 GHz for metro applications, simulations and measurements.**

Emilie Masson, Yann Cocheril, Pierre Combeau, Lilian Aveneau, Marion Berbineau, Rodolphe Vauzelle

### ► **To cite this version:**

Emilie Masson, Yann Cocheril, Pierre Combeau, Lilian Aveneau, Marion Berbineau, et al.. Radio wave propagation in curved rectangular tunnels at 5.8 GHz for metro applications, simulations and measurements.. EURASIP Journal on Wireless Communications and Networking, 2011, 2011 (202), pp.2011-202. 10.1186/1687-1499-2011-202 . hal-00745907

**HAL Id: hal-00745907**

**<https://hal.science/hal-00745907v1>**

Submitted on 26 Oct 2012

**HAL** is a multi-disciplinary open access archive for the deposit and dissemination of scientific research documents, whether they are published or not. The documents may come from teaching and research institutions in France or abroad, or from public or private research centers.

L'archive ouverte pluridisciplinaire **HAL**, est destinée au dépôt et à la diffusion de documents scientifiques de niveau recherche, publiés ou non, émanant des établissements d'enseignement et de recherche français ou étrangers, des laboratoires publics ou privés.

RESEARCH

Open Access

# Radio wave propagation in curved rectangular tunnels at 5.8 GHz for metro applications, simulations and measurements

Emilie Masson<sup>1\*</sup>, Yann Cocheril<sup>1</sup>, Pierre Combeau<sup>2</sup>, Lilian Aveneau<sup>2</sup>, Marion Berbineau<sup>1</sup>, Rodolphe Vauzelle<sup>2</sup> and Etienne Fayt<sup>3</sup>

## Abstract

Nowadays, the need for wireless communication systems is increasing in transport domain. These systems have to be operational in every type of environment and particularly tunnels for metro applications. These ones can have rectangular, circular or arch-shaped cross section. Furthermore, they can be straight or curved. This article presents a new method to model the radio wave propagation in straight tunnels with an arch-shaped cross section and in curved tunnels with a rectangular cross section. The method is based on a Ray Launching technique combining the computation of intersection with curved surfaces, an original optimization of paths, a reception sphere, an IMR technique and a last criterion of paths validity. Results obtained with our method are confronted to results of literature in a straight arch-shaped tunnel. Then, comparisons with measurements at 5.8 GHz are performed in a curved rectangular tunnel. Finally, a statistical analysis of fast fading is performed on these results.

**Keywords:** metro applications, wave propagation, ray launching, curved tunnels, arch-shaped tunnels

## 1. Introduction

Wireless communication systems are key solutions for metro applications to carry, at the same time, with different priorities, data related to control-command and train operation and exploitation. Driverless underground systems are one of the best examples of the use of such wireless radio system deployments based on WLAN, standards generally in the 2.45 or 5.8 GHz bands (New York, line 1 in Paris, Malaga, Marmaray, Singapore, Shangai, etc.). These systems require robustness, reliability and high throughputs in order to answer at the same time the safety and the QoS requirements for data transmission. They must verify key performance indicators such as minimal electric field levels in the tunnels, targeted bit error rates (BER), targeted handover times, etc. Consequently, metro operators and industries need efficient radio engineering tools to model the electromagnetic propagation in tunnels for radio planning and network tuning. In this article, we propose an original

method based on a Ray Launching method to model the electromagnetic propagation at 5.8 GHz in tunnels with curved cross section or curved main direction. The article is organized as follows. Section 2 details existing studies on this topic. Section 3 presents the developed method. A comparison of our results with the ones obtained in the literature is performed in Section 4 for a straight arch-shaped tunnel. Our method is then confronted to measurements at 5.8 GHz and validated in a curved rectangular tunnel in Section 5. A statistical analysis of simulated results in a curved rectangular tunnel is then performed in Section 6. Finally, Section 7 concludes the article and gives some perspectives.

## 2. Existing studies on radio wave propagation in curved tunnels

Different approaches to model the radio wave propagation in tunnels were presented in the literature. Analyses based on measurements represent the first approach but such studies are long and expensive [1,2]. Thus, techniques based on the modal theory have been explored [3-5]. The modal theory provides good results but is limited to canonical geometries

\* Correspondence: emilie.masson@ifsttar.fr

<sup>1</sup>Université de Lille Nord de France, IFSTTAR, LEOST, F-59650 Villeneuve d'Ascq, France

Full list of author information is available at the end of the article

since it considers tunnels as oversized waveguides. Some authors have also proposed an exact resolution of Maxwell's equations based on numerical techniques [6]. This kind of techniques is limited, specifically by the computational burden due to the fine discretization requirement of the environment, in terms of surface or volume. Finally, frequency asymptotic techniques based on the ray concept, being able to treat complex geometries in a reasonable computation time, seem to be a good solution. In [7], a model based on a Ray Tracing provides the attenuation in a straight rectangular tunnel. In [8], the author uses this method and adds diffraction phenomenon in order to analyze coupling between indoor and outdoor. In [9], studies are purchased by considering changes of tunnel sections. The main drawback of the Ray Tracing method is the impossibility to handle curved surfaces.

To treat curved surfaces, the first intuitive approach consists in a tessellation of the curved geometry into multiple planar facets, as proposed in [10]. However, the surfaces' curvature is not taken into account in this kind of techniques and the impossibility to define rules for the choice of an optimal number of facets versus the tunnel geometry and the operational frequency was highlighted. In [11], a ray-tube tracing method is used to simulate wave propagating in curved road tunnels based on an analytical representation of curved surfaces. Comparisons with measurements are performed in arch-shaped straight tunnels and curved tunnels. In [12], a Ray Launching is presented. The surfaces' curvature is taken into account using ray-density normalization. Comparisons with measurements are performed in curved subway tunnels.

This method requires a large number of rays launched at transmission in order to ensure the convergence of the results, this implies long computation durations but it provides interesting results and a good agreement with measurements. Starting from some ideas of this technique, we propose a novel method able to model the electromagnetic propagation in tunnels with curved geometry, either for the cross section or the main direction. This study was performed in the context of industrial application and the initial objective was clearly to develop a method where a limited number of rays are launched in order to minimize drastically the computation time. Consequently, instead of using the normalization technique of [12], we have developed an optimization process after the Ray Launching stage. The number of rays to be launched decrease from 20 million to 1 million. The final goal is to exploit the method intensively to perform radio planning in complex environments, such as tunnels at 5.8 GHz for metro applications.

### 3. Developed method

The method considered in this study is based on a Ray Launching method. The main principle is to send a lot of rays in the environment from the transmitter, to let them interact with the environment assuming an allowed number of electromagnetic interactions and to compute the received power from the paths which pass near the receiver. The implementation of this principle has led us to make choices that are detailed below.

#### 3.1. Ray Launching principle

With the Ray Launching-based methods, there is a null probability to reach a punctual receiver by sending rays in random directions. To determine if a path is received or not, we used a classical reception sphere centered on the receiver, whose radius  $r_R$  depends on the path length,  $r$ , and the angle between two transmitted rays,  $\gamma$  [13]:

$$r_R = \frac{\gamma r}{\sqrt{3}} \quad (1)$$

A contributive ray is one that has reached the reception sphere (Figure 1). This specific electromagnetic path between the transmitter and the receiver presents some geometrical approximations since it does not exactly go through the exact receiver position.

#### 3.2. Intersection between the transmitted rays and the environment

Two kinds of tunnel geometry have to be taken into account: The planes for the ceil and/or the roof, and the cylinder for the walls. These components are quadrics, which is important for the simplicity of intersection computation with rays. The intersection of ray with a cylinder (respectively a plane) leads to the resolution of an equation of degree 2 (respectively of degree 1).

#### 3.3. Optimization

The reception sphere leads to take into account *multiple rays*. The classical *identification of multiple rays* (IMR) algorithm consists in keeping one of the multiple rays.

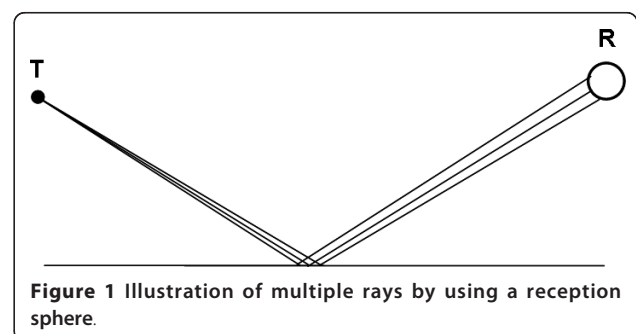

At this stage, the chosen one is still an approximation of the deterministic ray which exists between the transmitter and the receiver. So, to correct this problem, we propose to replace the classical IMR by an original optimization algorithm allowing modifying paths trajectories in order to make them converge to the real ones. We then disambiguate the choice of the ray to keep for a correct field calculation.

Using the Fermat Principle, indicating that the way followed by the wave between two points is always the shortest, we propose to reduce the geometrical approximation involved in each path. The optimization algorithm consists, for a given path, in minimizing its length, assuming that it exactly reaches the receiver (i.e., the center of the reception sphere).

While the path length function is not a linear one, we propose to use the Levenberg-Marquardt algorithm [14]. Its principle consists in finding the best parameters of a function which minimize the mean square error between the curve we try to approximate and its estimation.

Applied to propagation in tunnels, the aim becomes to minimize the path length. The  $J$  criterion to minimize is then the total path length equals to

$$J = \|\vec{EP}_1\| + \sum_{k=2}^N \|\vec{P_{k-1}P_k}\| + \|\vec{P_N R}\| \quad (2)$$

with  $E$  the transmitter,  $R$  the receiver and  $P_k$  the  $k$ th interaction point of the considered path, as illustrated in Figure 2.

The parameters vector contains the coordinates of the interaction points of the path. The iterative algorithm needs the Hessian matrix inversion, which contains the partial derivatives of the  $J$  criterion to minimize with respect to parameters. Then, in order to reduce computation time and numerical errors, we have to minimize the matrix dimensions and so the number of parameters. Thus, we decide to use local parametric

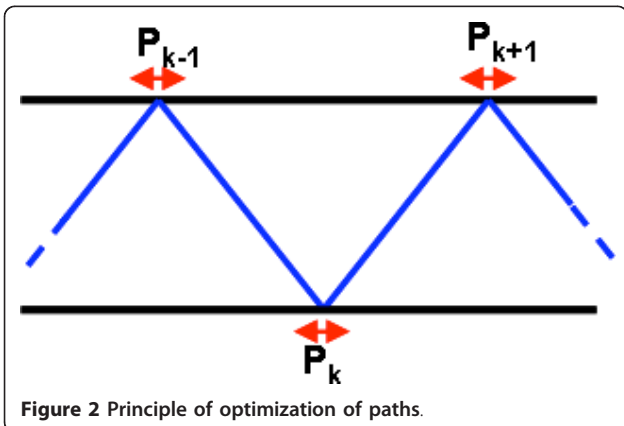

coordinates  $(u, v)$  from the given curved surface instead of global Cartesian coordinates  $(x, y, z)$ . The parameters vector  $\theta$  can be written

$$\theta = [u_1 v_1 \dots u_N v_N] \quad (3)$$

where  $(u_k, v_k)$  correspond to coordinates of the reflection point  $P_k$ .

A validation test is added after the optimization step in order to check if the Geometrical Optics laws are respected, specifically the Snell-Descartes ones. Concretely, we check, for each reflection point, if the angle of reflection  $\theta_r$  equals the angle of incidence  $\theta_i$ , as shown in Figure 3. Last step consists in the IMR technique in order to eliminate multiple rays. The optimization technique allows obtaining multiple rays very close to the real path, and consequently very close to each others. Nevertheless, due to numerical errors, they cannot be strictly equal each others. Thus, the IMR technique can be reduced to a localization of reflection points: If a reflection point of two paths is at a given maximal inter-distance equals to 1 cm, they are considered to be identical and one of the two is removed.

### 3.4. Electric field calculation

Figure 4 illustrates the reflection of an electromagnetic wave on a curved surface. In this case, electric field can be computed after reflection by classical methods of Geometrical Optics as long as the curvature radiuses of surfaces are large compared to the wavelength [15].

It can be expressed as follows (Figure 4):

$$\vec{E}^r(P) = \sqrt{\frac{\rho_1^r \rho_2^r}{(\rho_1^r + r)(\rho_2^r + r)}} e^{-jk_r r} \vec{R} \vec{E}^i(Q) \quad (4)$$

with  $\rho_1^r$  and  $\rho_2^r$  the curvature radiuses of the reflected ray,  $r$  the distance between the considered point  $P$  and the reflection point  $Q$  and  $\vec{R}$  the matrix of reflection coefficients.

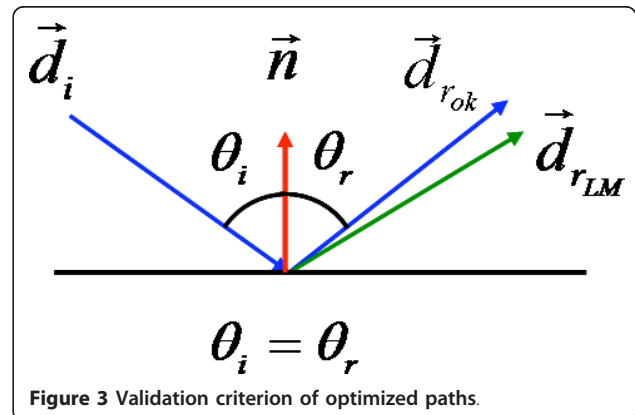

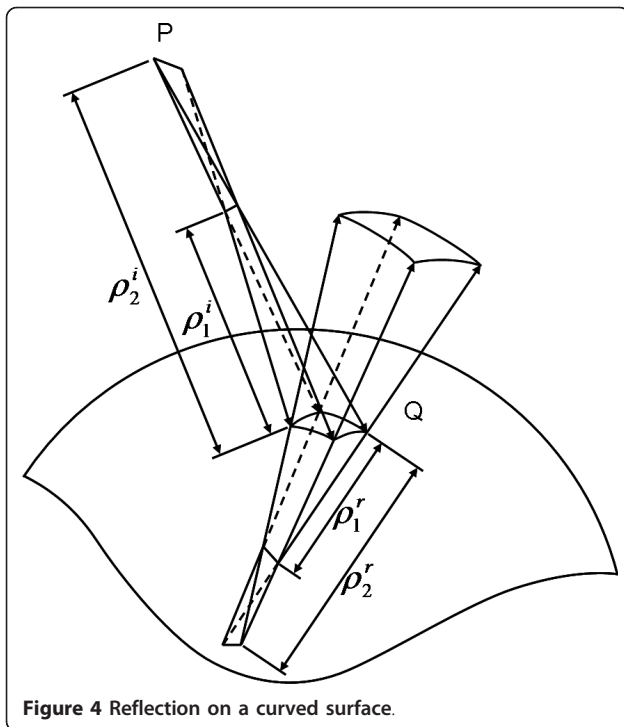

Figure 4 Reflection on a curved surface.

Contrary to the case of planar surfaces, the curvature radiuses of the reflected ray are different from the ones of the incident ray. Indeed, the following relation holds [15]:

$$\frac{1}{\rho_{1,2}^r} = \frac{1}{2} \left( \frac{1}{\rho_1^i} + \frac{1}{\rho_2^i} \right) + \frac{1}{f_{1,2}} \quad (5)$$

with  $\rho_1^i$  and  $\rho_2^i$  the curvature radiuses of the incident ray and  $f_{1,2}$  a function depending on  $\rho_1^i$ ,  $\rho_2^i$  and the curvature radiuses  $R_{1,2}$  of the curved surface.

#### 4. Comparisons with existing results

In this section, we compare the results obtained with our method with existing results in a straight arch-shaped tunnel (tunnel C) extracted from [11]. The configuration of simulation is presented in Figure 5a. It has to be noted that the developed method cannot afford the vertical walls, we then simulated the close configuration presented in Figure 5b.

Results are given in Figure 6. We must remember that the approach used in [11] is different from ours, because it considers a ray-tube tracing method, reflection on curved surfaces is also considered. Figure 6 highlights some similar results for the tunnel C. Deep fading is located in the same areas and Electric Field levels are globally similar along the tunnel axis. Differences that appear on field level are due to the difference in terms of representation of the configuration. Despite the geometric difference, the two methods lead to some similar results in terms of Electric Field levels which are the information considered for radio planning in tunnels.

#### 5. Comparisons with measurements

##### 5.1. Trial conditions

This section evaluates performances of the method proposed in the case of a real curved rectangular tunnel. Measurements presented in this section were performed by an ALSTOM-TIS team. The measurement procedure is as follows. The transmitter is located on a side near the tunnel wall. It is connected to a radio modem delivering a signal at 5.8 GHz. Two receivers, separated by almost 3 m, are placed on the train roof. They are connected to a radio modem placed inside the train. Tools developed by ALSTOM-TIS allow to

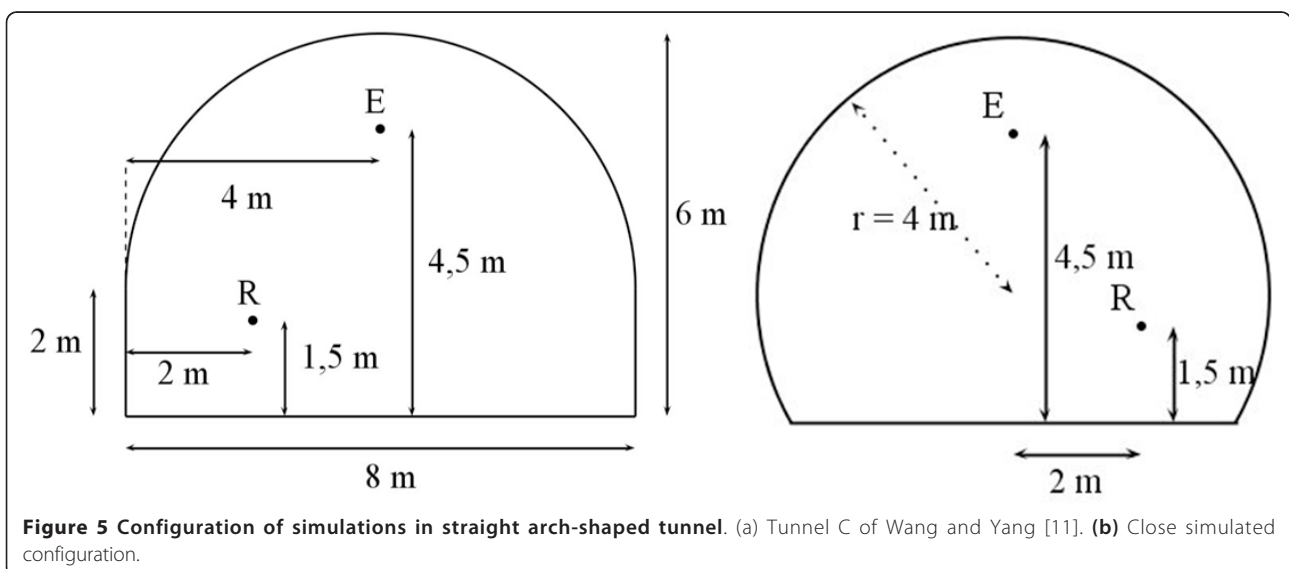
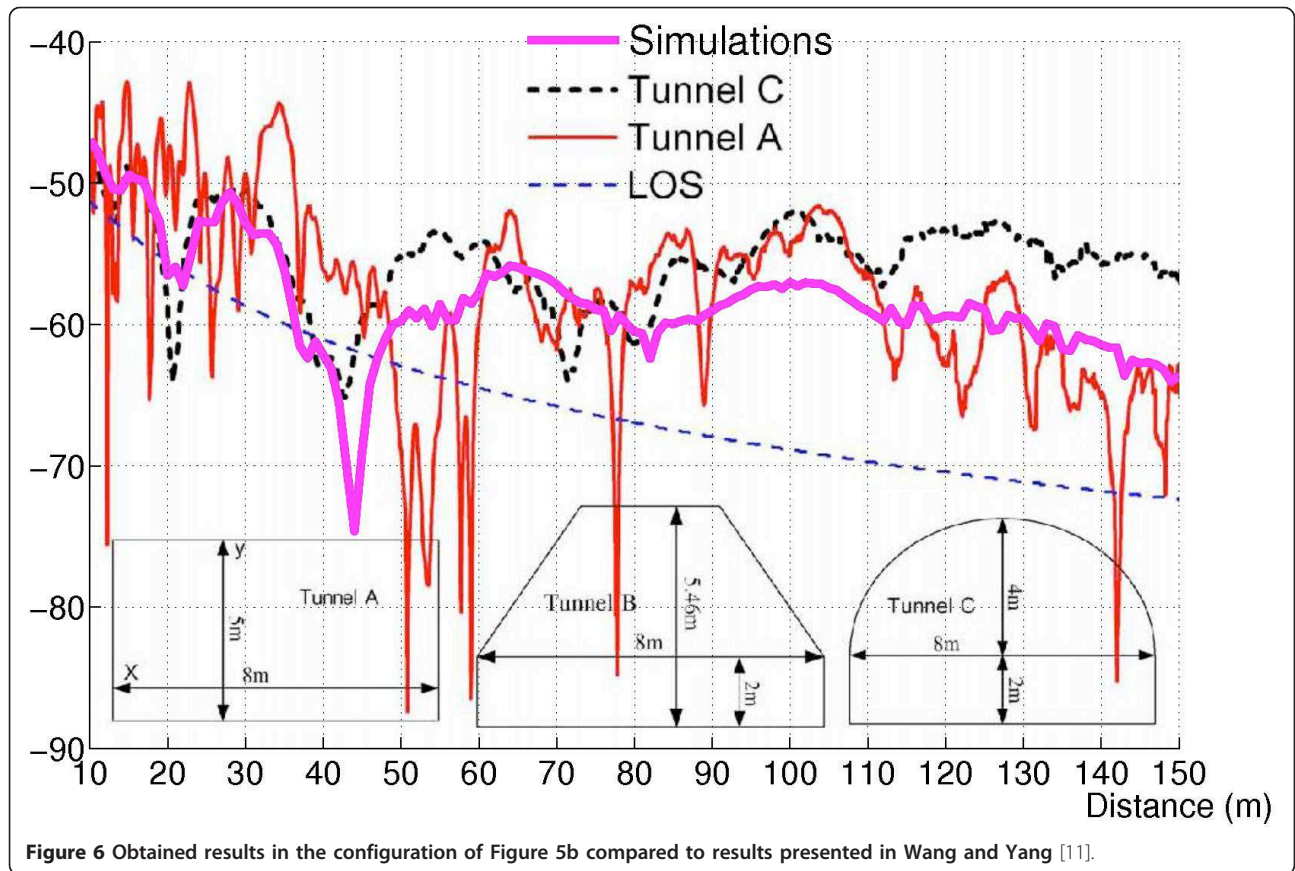

Figure 5 Configuration of simulations in straight arch-shaped tunnel. (a) Tunnel C of Wang and Yang [11]. (b) Close simulated configuration.



realize field measurements and to take into account a simple spatial diversity by keeping the maximum level of the two receivers. The measurements' configuration is depicted in Figure 7. The curved rectangular tunnel has a curvature radius equals to 299 m, a width of 8 m and a height of 5 m.

### 5.2. Simulation results

The geometric configuration has been reproduced for simulations, performed for the two receivers. Comparisons of measurements (black line) and simulations (grey line) are presented in Figure 8. The results are normalized by the maximum of the received power along the tunnel.

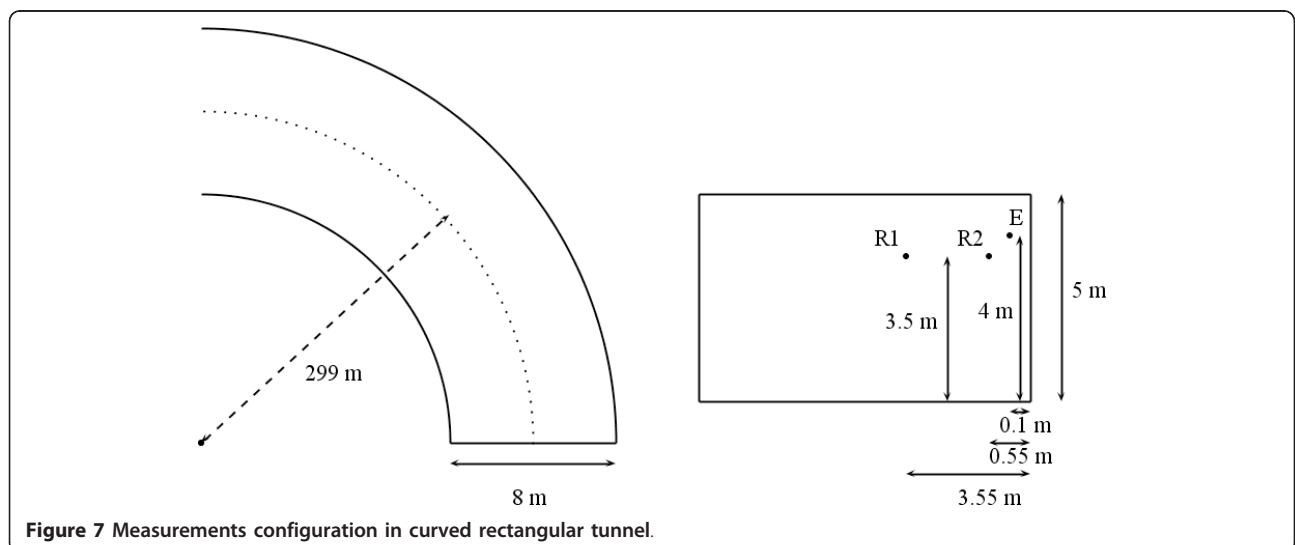

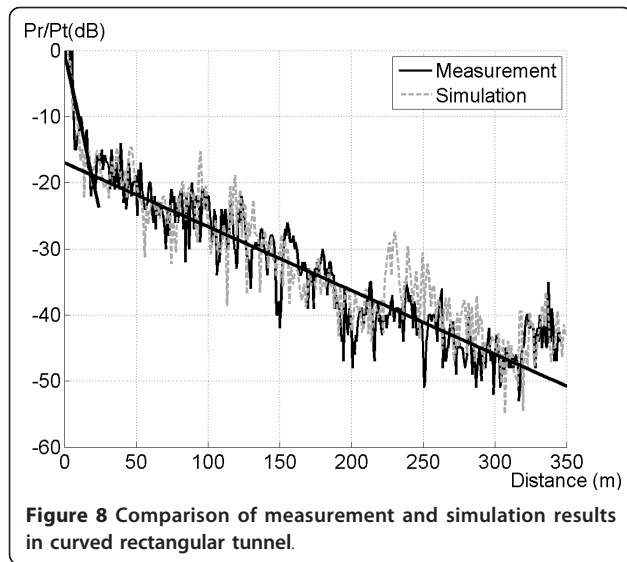

A quite good concordance between the simulations and the measurements is observed. A mean and a standard deviation of the error between measurements and simulations of 2.15 and 2.55 dB are, respectively, obtained. An error of about 2-3 dB highlights a quite good agreement between measurements and simulations considering usual rules in radio engineering.

### 5.3. 2-Slope model

As presented in [16] in the case of a straight rectangular tunnel, we observe in Figure 8 that longitudinal attenuation in the curved rectangular tunnel follows a 2-slope model until a distance of 350 m. The first break point is located around 20 m. First slope before the breakpoint is about 96 dB/100 m. Second slope after the breakpoint is about 10 dB/100 m.

This study highlights that the breakpoint is smaller in the case of a curved tunnel than for a straight tunnel (about 50 m). The longitudinal attenuation corresponding to the first slope is also very important. Furthermore, a very similar behavior is observed for both measurements and simulations. This type of very simple model based on path loss is really interesting from an operational point of view in order to perform easily radio planning in the tunnel. This approach provides a first validation of our method. The next step will be to perform further analysis in terms of slow and fast fading in order to margin gains for radio deployment for a system point of view to reach targeted BER and to tune the network and the handover process.

## 6. Statistical analysis of simulations in a curved rectangular tunnel

This section is dedicated to the statistical analysis of fast fading of the simulated results obtained by the method

described in Section 3. The configuration of the simulation is presented in Figure 7. First step consists in extracting fast fading by using a running mean. The window's length is  $40 \lambda$  on the first 50 m, and  $100 \lambda$  elsewhere, according to the literature [2]. Second step consists of a calculation of the cumulative density function (CDF) of the simulated results. Last step consists of applying the Kolmogorov-Smirnov (KS) criterion between CDF of simulated results and CDF of theoretical distributions of Rayleigh, Rice, Nakagami and Weibull. The KS criterion allows us to quantify the similarity between the simulation results and a given theoretical distribution. The four distributions have been chosen because they represent classical distribution to characterize fast fading.

A first global analysis is performed on 350 m and a second on the two zones presented in Section 5.3: Zone 1 (0-25 m) and Zone 2 (25-350 m). Figures 9, 10, and 11 present the CDF of the simulated results compared to those of the four previous theoretical distributions, respectively, for the global analysis, the Zones 1 and 2. It can be observed that results obtained with Rayleigh and Rice distribution are equal. Furthermore, the Weibull distribution seems to be the distribution that fits the best the simulated results, whatever the zone is. In order to prove it, Table 1 presents the values of the KS criteria between simulated results and the four theoretical distributions and the values of the estimated parameters of the distributions, for the three zones. The first observation is that the estimated distributions have a quite similar behavior whatever the zone is. Furthermore, it appears that the Weibull distribution better minimizes the KS criterion. The Weibull distribution is

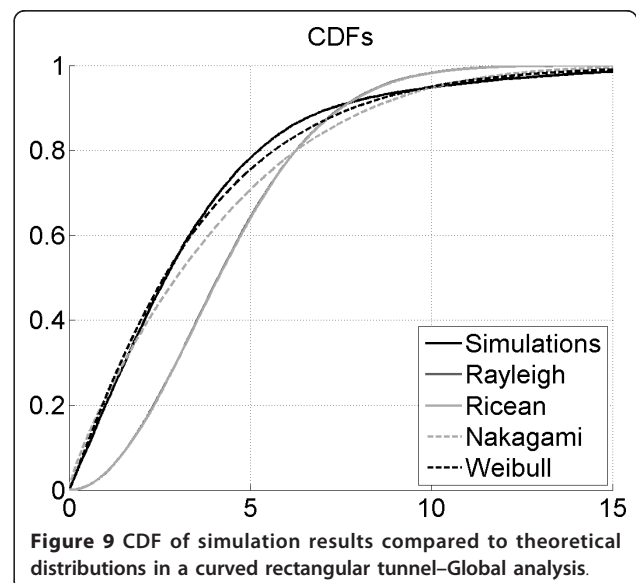

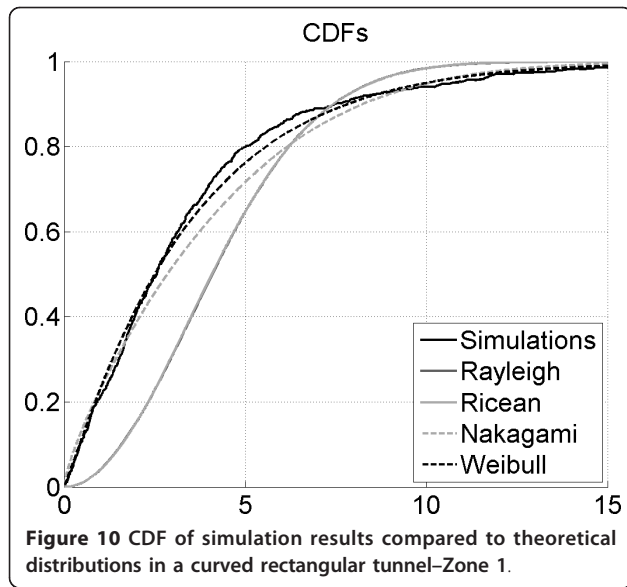

the distribution that best fits the simulated results for the global signals and also for the two zones.

It has to be noted that these results are similar to those obtained in the case of rectangular tunnels. Similar studies have been conducted in the case of rectangular straight tunnels and have shown that Weibull distribution is the distribution that best fits the simulated results.

### Conclusion

This article presented a novel original method to model the radio wave propagation in curved tunnels. It is based on a Ray Launching technique. A reception sphere is used and an original optimization of paths is

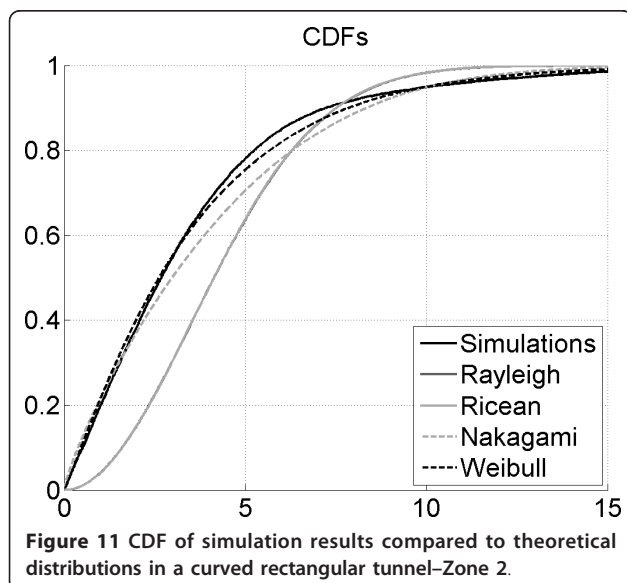

**Table 1** KS criteria between simulations and fitted distribution and values of fitted statistic distributions in a curved rectangular tunnel-5.8 GHz

	Global	Zone 1	Zone 2
Rayleigh			
KS	0.25	0.28	0.24
$\sigma$	3.50	3.48	3.50
Rice			
KS	0.25	0.28	0.24
$K$	0	0	0
$\sigma$	3.50	3.48	3.50
Nakagami			
KS	0.08	0.09	0.08
$m$	0.40	0.38	0.40
$\omega$	24.49	24.22	24.51
Weibull			
KS	0.03	0.04	0.03
$k$	3.65	3.53	3.66
$l$	1.09	1.05	1.09

added. It consists in a minimization of the path length, according to the Fermat Principle. Finally, an adaptive IMR has been developed based on the localization of reflection points.

Results obtained in a straight arch-shaped tunnel are first compared to that of presented in the literature. We then treated the specific case of a curved rectangular tunnel by comparisons with measurement results performed in a metro tunnel. The results highlighted good agreement between measurements and simulations with an error lower than 3 dB. Using a classical path loss model in the tunnel, we have shown a good agreement between measurements and simulations at 5.8 GHz showing that the method can be used to predict radio wave propagation in straight and curved rectangular tunnels for metro applications. Finally, a statistical analysis of fast fading was performed on the simulated results. It highlighted a fitting with the Weibull distribution.

The main perspective would be to be able to consider complex environments such as the presence of metros in the tunnel. In this case, we have to implement diffraction on edges by using Ray Launching and also diffraction on curved surfaces.

### Acknowledgements

The authors would like to thank the ALSTOM-TIS (Transport Information Solution) who supported this study. Furthermore, this study was performed in the framework of the I-Trans cluster and in the regional CISIT (Campus International Sécurité et Intermodalité des Transports) program.

### Author details

<sup>1</sup>Université de Lille Nord de France, IFSTTAR, LEOST, F-59650 Villeneuve d'Ascq, France <sup>2</sup>XLIM-SIC Laboratory of the University of Poitiers, France <sup>3</sup>ALSTOM-TIS (Transport Information Solution), F-93482 SAINT OUEN, Cedex, France



### Competing interests

The authors declare that they have no competing interests.

Received: 19 July 2011 Accepted: 15 December 2011

Published: 15 December 2011

### References

1. YP Zhang, HJ Hong, Ray-optical modeling of simulcast radio propagation channels in tunnels. *IEEE Trans Veh Technol.* **53**(6), 1800–1808 (2004)
2. M Lienard, P Degauque, Propagation in wide tunnels at 2 GHz: a statistical analysis. *IEEE Trans Veh Technol.* **47**(4), 1322–1328 (1998)
3. KD Laakmann, WH Steier, Waveguides: characteristic modes of hollow rectangular dielectric waveguides. *Appl Opt.* **15**(5), 1334–1340 (1976)
4. A Emslie, R Lagace, P Strong, Theory of the propagation of UHF radio waves in coal mine tunnels. *IEEE Trans Antenn Propag.* **23**(2), 192–205 (1975)
5. DG Dudley, SF Mahmoud, Linear source in a circular tunnel. *IEEE Trans Antenn Propag.* **54**(7), 2034–2047 (2006)
6. P Bernardi, D Caratelli, R Cicchetti, V Schena, O Testa, A numerical scheme for the solution of the vector parabolic equation governing the radio wave propagation in straight and curved rectangular tunnels. *IEEE Trans Antenn Propag.* **57**(10), 3249–3257 (2009)
7. S Mahmoud, Characteristics of electromagnetic guided waves for communication in coal mine tunnels. *IEEE Trans Commun Syst.* **22**(10), 1547–1554 (1974)
8. P Mariage, M Lienard, P Degauque, Theoretical and experimental approach of the propagation of high frequency waves in road tunnels. *IEEE Trans Antenn Propag.* **42**(1), 75–81 (1994)
9. M Agunaou, S Belattar, P Mariage, P Degauque, Propagation d'ondes électromagnétiques hyperfréquences à l'intérieur d'un métro-Modélisation numérique de l'influence des changements de section. *Recherche Transports Sécurité.* **64**, 55–68 (1998)
10. E Masson, P Combeau, Y Cocheril, M Berbineau, L Aveneau, R Vauzelle, Radio wave propagation in arch-shaped tunnels: measurements and simulations using asymptotic methods. *CR Phys.* **11**, 44–53 (2010)
11. TS Wang, CF Yang, Simulations and measurements of wave propagations in curved road tunnels for signals from GSM base stations. *IEEE Trans Antenn Propag.* **54**(9), 2577–2584 (2006)
12. D Didascalou, TM Schafer, F Weinmann, W Wiesbeck, Ray-density normalization for ray-optical wave propagation modeling in arbitrarily shaped tunnels. *IEEE Trans Antenn Propag.* **48**(9), 1316–1325 (2000)
13. SY Seidl, TS Rappaport, Site-specific propagation prediction for wireless in-building personal communication system design. *IEEE Trans Veh Technol.* **43**(3), 879–891 (1994)
14. DW Marquardt, An algorithm for least-squares estimation of nonlinear parameters. *J Soc Indust Appl Math.* **11**(2), 431–441 (1963)
15. CA Balanis, *Advanced Engineering Electromagnetics* (John Wiley and Sons, 1989)
16. Document Cost231 TD(95) 031–Thomas Klemenschits, Ernsts Bonek-Radio Coverage of Tunnels by Discrete Antennas: Measurement and prediction (1995)

doi:10.1186/1687-1499-2011-202

**Cite this article as:** Masson et al.: Radio wave propagation in curved rectangular tunnels at 5.8 GHz for metro applications, simulations and measurements. *EURASIP Journal on Wireless Communications and Networking* 2011 **2011**:202.

Submit your manuscript to a SpringerOpen<sup>®</sup> journal and benefit from:

- Convenient online submission
- Rigorous peer review
- Immediate publication on acceptance
- Open access: articles freely available online
- High visibility within the field
- Retaining the copyright to your article

Submit your next manuscript at ► [springeropen.com](http://springeropen.com)