



HAL
open science

Integrated Multi-trophic Aquaculture (IMTA): A sustainable, pioneering alternative for marine cultures in Galicia.

Salvador Guerrero, Javier Cremades

► **To cite this version:**

Salvador Guerrero, Javier Cremades. Integrated Multi-trophic Aquaculture (IMTA): A sustainable, pioneering alternative for marine cultures in Galicia.. Guerrero S., Cremades J. Regional Government of Galicia (Spain), pp.111, 2012, 13:978-84-695-3260-7. <hal-00743395>

HAL Id: hal-00743395

<https://hal.science/hal-00743395v1>

Submitted on 22 Oct 2012

HAL is a multi-disciplinary open access archive for the deposit and dissemination of scientific research documents, whether they are published or not. The documents may come from teaching and research institutions in France or abroad, or from public or private research centers.

L'archive ouverte pluridisciplinaire **HAL**, est destinée au dépôt et à la diffusion de documents scientifiques de niveau recherche, publiés ou non, émanant des établissements d'enseignement et de recherche français ou étrangers, des laboratoires publics ou privés.



HAL Authorization



Published by

Regional Government of Galicia
Regional Council of the Rural
and Regional Maritime Environment
Marine Research Centre

Vilanova de Arousa (Pontevedra)
2012

Editors

Salvador Guerrero; Javier Cremades

Editorial

Jorge García

Translation

Ian Emmett

Cover illustrations

Xaquín Chaves

**Coordination, design,
graphics editing, infography and lay-out**

Margarita Paulos



www.margapaulos.com
margapaulos@gmail.com

This edition has been funded through
the JACUMAR National Plan entitled
*"Acuicultura Integrada: experiencias piloto
para el desarrollo de sistemas de cultivo
multitróficos, 2008-2011"*
(*"Integrated aquaculture: pilot experiences
for the development of multitrophic culture
systems, 2008-2011"*), from the Spanish Ministry
of Agriculture, Food and Environment.

INTEGRATED MULTI-TROPHIC AQUACULTURE

A sustainable, pioneering alternative
for marine cultures in Galicia



XUNTA DE GALICIA
Consellería do Medio Rural e do Mar
Centro de Investigacións Mariñas

Vilanova de Arousa (Pontevedra)
2012

Integrated Multi-trophic Aquaculture: The essence of a pioneering commitment to sustainability



Rosa Quintana Carballo.
Regional Counsellor for
the Rural and Maritime
Environment.

The notion that European aquaculture should make a decided effort to relaunch its mission to provide food, to generate employment and economic wealth is a fact that is firmly implanted in all administrative spheres, be they at community, state or regional level.

Furthermore, in Galicia this mission is being tackled with the best mechanisms available, with know-how and expertise, seeking to achieve far-reaching results, doing so in a positive manner, to ensure that this activity will be fully sustainable in social, economic and environmental terms, in such a manner that the combination of all these elements will be fully balanced.

There is no doubt about the fact that, in times such as these, where it is necessary to provide ourselves with sources of nutritional foods and tested hygiene-sanitary safety, apart from having a revitalizing element as well as economic and employment diversification in the coastal areas where it is and intends to continue to be a cornerstone in the way of living of local inhabitants.

But however, if there is a concept able to harness the essence of progress in this common commitment to the future of

aquaculture, it is integrated multi-trophic aquaculture (IMTA) as this demonstrates that it is a way of drawing together expertise, commitment to the future and the awareness as to how to progress towards it.

IMTA is primed to achieve total respect for the environment where waste is converted into usable assets, while consumables are kept to a minimum, thus contributing to sustain the activity in the best possible manner.

Also, this work formula takes on board and captures the need to move ahead in making use of and optimizing the space, ensuring that the impact of aquaculture is reduced in coastal areas.

Finally, it is essential to highlight the ability of this production formula when referring to its capacity to draw synergies and diversification together, in terms of economic activity since the interdependence of cultures and the possibility to generate mutually beneficial relationships are aspects to be taken into account when it comes to expanding IMTA into practical production terms.

Galicia is firmly committed to aquaculture and has done so directly and practically by drafting and developing the Galician

Aquaculture Strategy, which will have, as far as common objectives are concerned, an element of reference in IMTA to work on the way ahead in the development of Galician aquaculture.

IMTA may, in the case of Galicia, be a vital driving force for the future and may trigger achieving this relaunching of aquaculture, steering it towards a rationalization of uses of space, of achieving full economic activity of positive synergies with zero impact on the environment. To this end, it is our intention and duty, at the Regional Council for the Rural and Maritime Environment, to be involved in its development and practical implementation.

But to achieve this, initiatives such as this publication, promoted by Salvador Guerrero and Javier Cremades, are vital as they clearly set out our heading for us while helping us to define it better.

It is to them and their collaborators that we extend our thanks, on behalf of the administration and the aquaculture sector since by obtaining, as indicated in the heading, of a sustainable, pioneering alternative for our marine cultures, holds a vital key in IMTA. With this initiative, Galicia draws nearer to relaunching its aquaculture on the right road.

ACKNOWLEDGEMENTS

We wish to express our thanks to the Marine Culture Advisory Committee (JACUMAR), for promoting and backing the programme of multi-trophic aquaculture experiences conducted in Galicia, an initiative that has made this publication possible. Likewise, mention should be made of the Regional Council for the Rural and Maritime Environment at the Regional Government of Galicia for supporting and taking on the management of areas of the project, besides solving many of the problems of all kinds that arose in the course of the various experiences.

The disinterested, voluntary collaboration of the companies that have provided us with access to their facilities, granting areas, energy and seawater, have been essential elements for carrying out our experiences.

Our thanks are also due to the personnel that has worked and continues working in the project, both grant holders and contracted staff, students on practicals as well as students on the Galician Inter-university Master Degree course, who have completed their end of master degree work in some of the experiences in the project:

CIMA (Centro of Marine Research)

Cristina Ancosmede Garduño; Josefa Domínguez Bastos; Alejandro Cores Rodríguez; Laura Pérez Piñeiro

University of A Coruña

Ahmed Fawzi Ali Alamrousi; Marta Andrade García; Daniel Carcajona Alcol; Sonia Ocaña Falcón; Sergio Pérez Cordero; José Ribamar Da Cruz Freitas Junior

El Bocal Algae Culture Facility (Spanish Institute of Oceanography, Santander)

Juan Manuel Salinas; Carmen Fuertes

Aquacría S.L.

Sergio Devesa

Porto Muiños S.L.

Antonio Muiños

Punta Moreiras S.L.

José Juan Sanmartín Ruano

Marcultura S.A.

Antonio Pallarés Méndez

Seasalter Shellfish Ltd.

Pablo Guerrero Gómez

Intertidal Parks

María Otero Otero in O Grove
José Antonio Rodríguez Méndez in Carril

Technicians at the mollusc “mini-nursery” in Camariñas Regional Council for the Rural and Maritime Environment /CETMAR

Intecmar (Technological Institute for the Monitoring of the Marine Environment in Galicia)

Canadian Embassy in Madrid

Lorraine Choquette

FORWARD

The processes involved in marine and continental aquaculture have the advantage of being able to be developed in extensive coastal or fluvial zones, with the proviso that their activities are seen to be sustainable for the environment. This is currently the main challenge facing the marine culture sector, which, according to FAO data, is very close to reaching 50% of the total amount of fish annually assigned to human consumption worldwide.

Also, the increasing difficulties in extractive fishing and the increasing influence and efficacy of the regional fisheries organizations that also regulate this activity, lead to forecasts that, with the due sanitary guarantees and a sustainable production strategy, aquaculture is heading for becoming the provider of an increasingly important quota of proteins, both of animal and vegetable origin, usable in our food.

The “boom” in the growth of aquaculture experienced since the nineties has been termed the Blue Revolution because the production and distribution of farmed marine products has increased, over a period of 20 years, to become consolidated as a similar offer and in competition with that of caught fish.

Fisheries administrations at autonomic, state, regional community and international levels work with the fishfarming industry in drafting sustainability regulations for this increasingly efficient activity. This process calls for responsible practices and systems, with a need for research to enable aquaculture to

be ecologically efficient, environmentally friendly, diversified and profitable; in short, a socially beneficial activity. Integrated Multi-trophic Aquaculture (IMTA) is a production strategy, which, through the combined culture of different commercial species, has sufficient potential to achieve such objectives. It is set to head the so-called Turquoise Revolution.

In some countries with a highly developed aquaculture, IMTA generates an added value to marine cultures since its products have access to labelling that certifies to consumers that the fish, crustacean, mollusc or alga has been reared with systems that have a low, zero or even a positive impact on the environment.

The experiences described in this publication have, as one of their main references, involved the ideas and criterion of Thierry Chopin, a scientist leading the most prestigious international research group in this field, whose works are considered as foundational in IMTA. As a result of our relationship with Chopin, established at the very outset of this work, us researchers working in this field in Galicia were invited to collaborate in drafting a publication that would divulge the extent to which these methods in worldwide aquaculture are currently in place and just what their outlook for the future is.

Salvador Guerrero and Javier Cremades, April, 2012

CONTENTS

1		
SUSTAINABLE ALTERNATIVE FOR DIVERSIFYING CULTURES AND FOR PROTECTING MARINE ENVIRONMENT QUALITY	9	
ECOSYSTEMIC APPROACH	11	
SCIENTISTS AND WORK	13	
INTERNATIONAL PROGRAMMES	16	
THE JACUMAR PROJECT	16	
2		
MACROALGAE, EFFICIENT BIOFILTRATORS WITH COMMERCIAL VALUE	21	
CREATING ECOSYSTEMS	22	
BIOFILTERING WITH MACROALGAE	23	
SELECTION CRITERION	25	
THE BEST CANDIDATES	26	
NEW PRODUCTS, NEW MARKETS	28	
3		
DR. THIERRY CHOPIN PROPOSES A DEVELOPMENT TOWARDS MARINE CULTURES THAT ARE MORE RESPONSIBLE WITH THE ECOSYSTEM	31	
<i>“IMTA is the general concept, but like in Bach’s music, there are themes and many variations”</i>		
The French-born scientist, who emigrated to Canada in 1989, is considered by many to be one of the key leaders in the development of Integrated Multi-Trophic Aquaculture	31	
4		
RESEARCH BODIES AND THE PRIVATE SECTOR		
TAKE PART IN EXPERIENCES WITH INTEGRATED AQUACULTURE IN GALICIA	37	
Integrated farming of macroalgae in fish cages in the ria of Muros and Noia (A Coruña)	39	
DESCRIPTION OF THE EXPERIENCE	40	
RESULTS AND DISCUSSION	41	
REFERENCES	43	
Open sea farming of the food seaweed <i>Saccharina latissima</i> associated with floating mussel beds in the Ria of Ares and Betanzos (A Coruña)	45	
DESCRIPTION OF THE EXPERIENCE	46	
RESULTS AND DISCUSSION	48	
REFERENCES	49	
Biofiltration of solids from the effluent of a turbot farming plant in a closed circuit, with filtering molluscs (clam and oyster), suspensivore invertebrates (anemone) and food macroalgae (<i>Saccharina latissima</i> , <i>Codium</i> spp. y <i>Ulva</i> spp.) in O Grove (Pontevedra)	51	
DESCRIPTION OF THE EXPERIENCE	52	
RESULTS	54	
CONCLUSIONS	57	
Ongrowing of grooved carpet shell and carpet shell clams from multi-trophic seedbed at the farming park in Carril (Pontevedra)	58	
OBJECTIVE	58	
MATERIAL AND METHODS	58	
RESULTS	60	
CONCLUSIONS	61	
Incorporation of cultures of <i>Saccharina latissima</i> and of suspensivore and filtering invertebrates in a turbot and common sole production plant, with water recirculation, in Cambados (Pontevedra)	63	
PREVIOUS EXPERIENCES	64	
FOOD MACROALGAE CULTURES	65	
INVERTEBRATE CULTURES. ANEMONES	67	
POLYCHAETES	68	
CONCLUSIONS	69	
5		
TESTIMONIALS	71	
Scientists and experts provide criteria, data and results of experiences in the field of sustainable integrated aquaculture	71	

Integrated Multi-Trophic Aquaculture (IMTA)

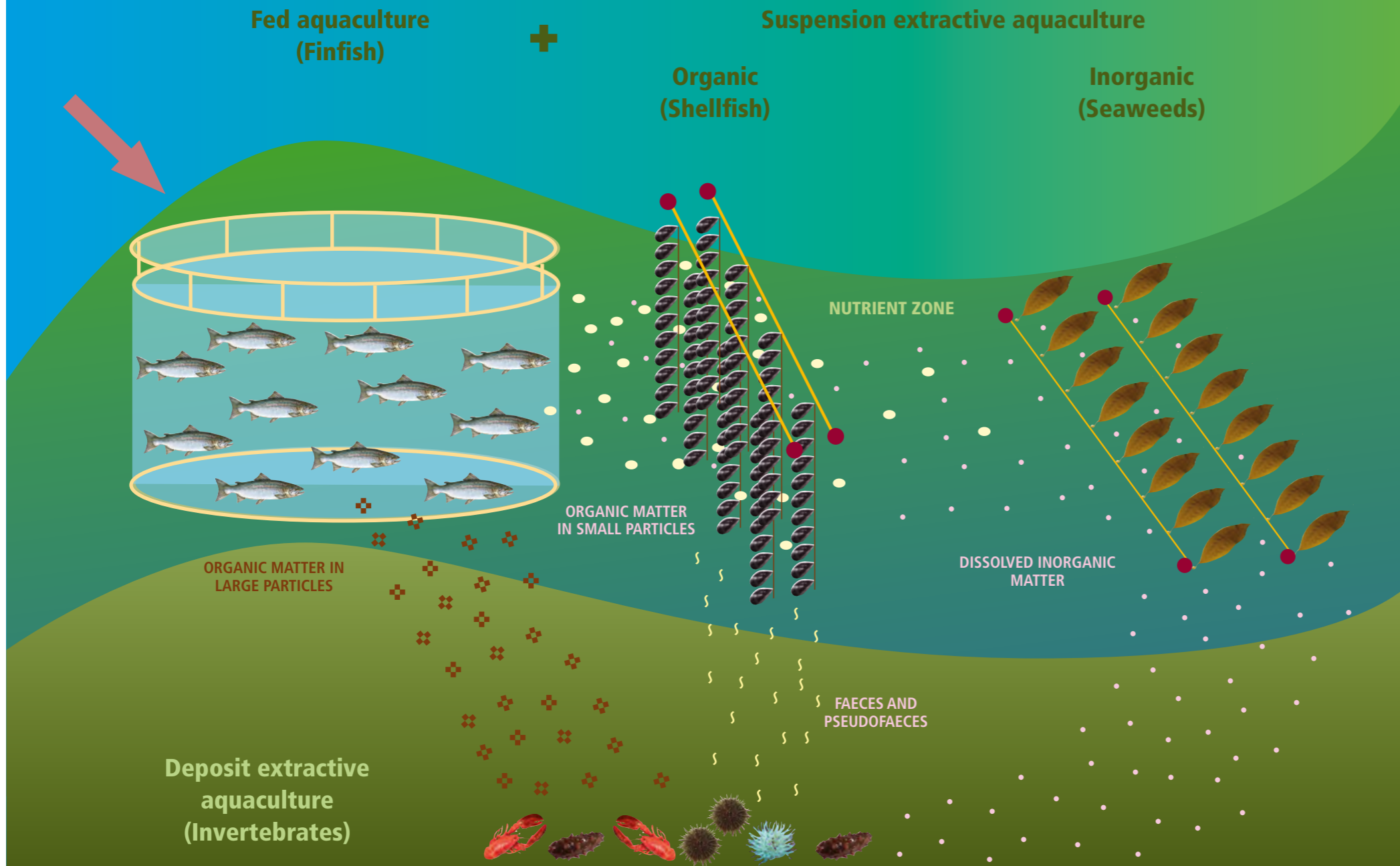

SUSTAINABLE ALTERNATIVE FOR DIVERSIFYING CULTURES AND FOR PROTECTING MARINE ENVIRONMENT QUALITY

By Jorge García (garcia.herosa@gmail.com)

The growing interest shown over the last few years by a number of countries with a fishing tradition in researching into Integrated Multi-trophic Aquaculture (IMTA) is positive, promising news for the future of marine cultures. Experimental works conducted in this field, over the last three decades, in Canada, Chile, South Africa, Israel and China (Chopin et al., 2008; Barrington et al., 2009) and, more recently, in the United Kingdom (particularly in Scotland), Ireland, Spain, Portugal, France, Turkey, Norway, Japan, Korea, Thailand, U.S.A. and Mexico, are aimed experimenting with integrating fish cultures with those of algae, molluscs, crustaceans and other marine invertebrates.

In this regard, it is a widespread notion in the scientific community that one of the most complex stages of these processes at the industrial phase, is to make a selection of species that are efficient while finding the correct proportion in which they should occur.

Another of the main criterion in this line of work is that the use of the different trophic levels of the various farmed species makes it possible to set up a balanced fish farm production system, apart from leading to

Recreation of the basic set up with which Thierry Chopin describes a combination of integrated marine cultures, with different trophic levels.



an improvement in production and quality of waters, both in the marine environment itself and in open or closed circuit systems of fish farm production.

Another of the generalized opinions among researchers is that diversification of aquaculture as an alternative to monoculture is one of the best roads towards environmental sustainability and economic feasibility and, as a result, achieves better social acceptance. In the case of Galicia, IMTA is a solid option for diversification in aquaculture, which has been taken on board and put into

practice in other countries, in a planned, spontaneous manner, drawing together three types of aquaculture:

- Food aquaculture (fish, crustaceans, browsing molluscs).
- Organic extraction aquaculture (filtering and suspensivore invertebrates).
- Inorganic extraction aquaculture (marine macroalgae).

A substantial part of the scientists researching into this field also share the idea that IMTA makes it possible to develop a series of processes and practices that make it industrial

A sea cage for on-growing turbot, one of the species most intensively farmed in Galicia.



feasible to convert sub-products generated by rearing certain species into habitat and food for other species. This involves a highly sustainable production strategy, whose implementing generates efficient ecosystems to the benefit of the quality of the marine environment, while facilitating diversification of aquaculture.

ECOSYSTEMIC APPROACH

The IMTA approach is ecosystemic, and helps to apply the Code of Conduct for Responsible Fishing approved by the FAO in 1995. This Code, among other aspects, sets out to ensure "the effective conservation,

management and development of living aquatic resources, with due respect for the ecosystem and biodiversity", as noted by the FAO Committee on Fisheries, in the document approved in Rome at the 19th session, held from 31st January to 4th February 2011. As is known, both the ecosystemic approach to Fishing (EAF) and to aquaculture (EAA) are holistic strategies in the management of commercial fishing and aquaculture, drawing together the ecological, socio-economic and institutional dimensions of the activity that are also linked to the social responsibility of companies.

Saccharina latissima (sugar kelp), a macroalga farmed on an experimental basis at the CIMA for the multi-trophic cultures programme by JACUMAR.

Furthermore, but in this same regard, it should be noted that the presence of algae in all the combinations of multi-trophic cultures ensures the effects of biomitigation while significantly reducing eutrophication of waters.

The positive results obtained by scientists

to date, in various countries, has begun to encourage IMTA consolidation processes in Canada, Israel, Chile, South Africa and Australia, states where the fisheries administrations and aquaculture industry value it as a solid production alternative. The number of fishfarming companies in these countries that have industrially

Photo: R.J. Anderson



Photo: JM. Shpigely y B. Scharfstein



integrated their cultures with those of algae and molluscs with a commercial value is considerable.

In China and other Asian countries, there are efficient examples of cultures integrating fish, molluscs and crustaceans with algae cultures, although no proven data is available on the extent and magnitude of such productions. The Research Centre at the University of Los Lagos, in Puerto Montt, Chile, is working to reduce the environmental impact of intensive salmon farming. Cultures of trout, oysters and marine algae have also been integrated. Currently, salmon, marine algae and abalone are being combined in open waters. The director of these projects is the researcher, Alejandro Buschmann. In Israel, there are at least three marine farms where IMTA is applied.

Furthermore, the FAO has pointed out in its annual report, "The State of World Fisheries and Aquaculture, 2010", that, "reduce environmental (of marine cultures)". This is a recognition, by the United Nations body, of the efficacy of IMTA in this field, which is interesting when related to the forecast made by this organization that in the year 2030, 50% of marine food production will come from aquaculture.

SCIENTISTS AND WORK

Most researchers working in this field agree on the fact that Drs. Thierry Chopin, at the University of New Brunswick, in Saint John's, and Shawn Robinson, at the Saint Andrews Biological Station of the Ministry of Fisheries and Oceans Canada, have contributed to

the scientific community and to industry – since the 1990's – with the main criterion, references and guidelines with which IMTA works internationally.

"With these processes (IMTA), all the cultivation components have an economic value, as well as a key role in environmental and societal services and benefits", Chopin commented when accepting the 2009 Research Award of Excellence awarded by

On the previous page, reading from left to right and from top to bottom: integrated culture farm for abalone/macroalgae, in East London, South Africa (D. Robertsson, J. Bolton, M. Troell); SeaOr Marine Enterprises, integrated abalone/sea bream/macroalgae culture farm, in Mikhmoret, Israel (B. Scharfstein, A. Neori); closed circuit fish and macroalgae culture farm, in Bribie Island, Queensland, Australia (W. Knibb); integrated salmon/oyster/macroalgae culture farm, in Metri, Chile (A. Buschmann). On this page: experimental integrated salmon/mytilidae/Saccharina culture, in the Bay of Fundy, Canada. Source: Ministry of Fisheries and Oceans, Canada. www.dfo-mpo.gc.ca





the Aquaculture Association of Canada, an award shared with Robinson for creating and developing the concepts of Integrated Multi-trophic Aquaculture, from the laboratory stage to its industrial application.

One of the latest works by Chopin and Robinson, in this field, was presented, along with another two researchers, from Canada, Sweden, China and Chile, at "Aquaculture Europe 10", held in the town of Porto, Portugal, in 2010, organized by the European Aquaculture Society.

In his latest work, Chopin reiterates IMTA as "a responsible practice for simultaneously obtaining diversified marine products with biomitigation effects on the environmental impact of aquaculture activity". The researcher noted that this production alternative, with interacting species and spaces, is also a flexible one: it accepts a number of combinations and can be developed in closed and open circuit fishfarming plants, as well as with cultures in the marine environment itself.

One of the reference production models quoted by the researchers is that put in place by the Canadian state network

Data gathering operations in an IMTA facility, combining macroalgae, mussel and salmon, in Canadian waters. Below, macroalga culture cage. Source: Ministry of Fisheries and Oceans, Canada. www.dfo-mpo.gc.ca

of research and innovation in AquaNet aquaculture (www.dfo-mpo.gc.ca) in New Brunswick bay, integrating salmon farming with that of mussel and alga. The company commercially distributing this salmon includes in its publicity and on the product packaging the warning that this species has been 100% farmed with sustainable aquaculture techniques.

In terms of the progress made by his

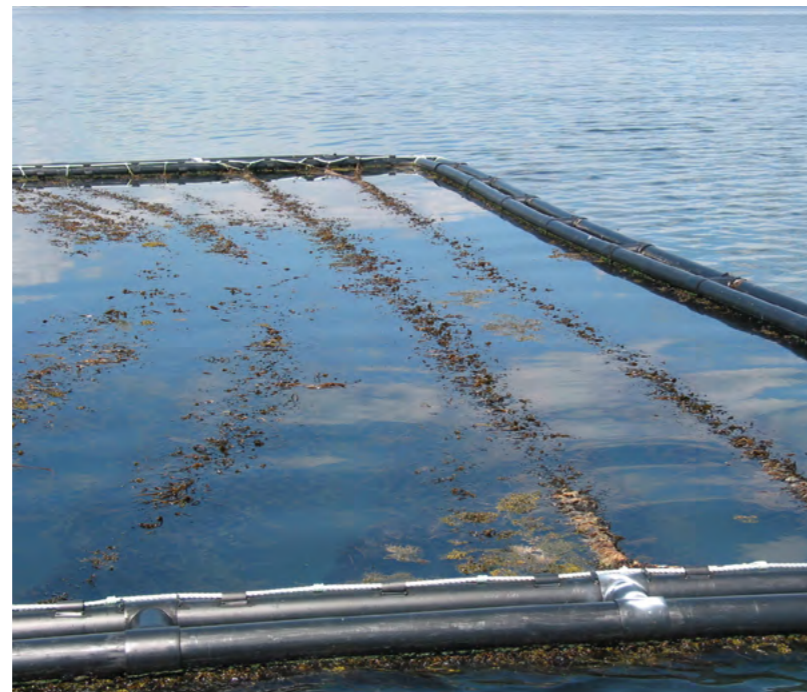

proposal, the researcher has made a graph showing a series of stages, starting in 1995, extending up to 2012, at which point it was considered that IMTA had consolidated its presence in the industry of marine farming. For greater detail regarding the work by Chopin and his team of collaborators, please consult the website www.unbsj.ca/sasel/biology/chopinlab/.

The work mentioned also includes comparative tables of production costs and possible benefits from marketing single culture marine species, compared with rearing using IMTA systems and processes. Objective and competitive advantages are ascribed in these tables to the latter. As far as eliminating the nitrogen generated in the marine environment is concerned due to

the intensive farming of filtering molluscs, Chopin ensures that growing algae with a commercial value is one of the most efficient solutions in "ecological engineering".

Lastly, the scientist defines IMTA as the "turquoise revolution" as it involves integrating the ideas of the "green revolution" with that of the "blue revolution". As is known, the former is the name internationally given to describe and explain the increased world agricultural production, particularly in food, from 1940 and 1970. The term "blue revolution" refers to aquaculture, since around 1960, to ensure a regular supply to the markets of marine products, with standards agreed on regarding freshness, sizes and prices. Chopin firmly believes that IMTA is set to



An IMTA facility, with salmon cages and floating mussel beds, with the Pandalus III coastguard vessel in the background. The Pandalus provides regular support for IMTA scientific research in the Bay of Fundy. Source: Ministry of Fisheries and Oceans, Canada. www.dfo-mpo.gc.ca

being the “turquoise revolution” in view of its contribution of productive rationality to optimize cultures and also its biomitigation effects on the marine environment.

INTERNATIONAL PROGRAMMES

Marine research bodies involved in this field in other countries, that have set up programmes related to integrated multi-trophic aquaculture include AquaNet (www.dfo-mpo.gc.ca) and Genesis Faraday, under the Biosciences Knowledge Transfer Network, based in Edinburgh, United Kingdom. This multi-trophic programme in Scotland entails the “Development of a generic approach to sustainable integrated marine aquaculture systems for European environments and markets”, with scientists taking part from various countries, such as France and Israel. Further details of Genesis Faraday can be found on the website www.scotsman.com

For its part, the Scots Marine Association (www.sams.ac.uk) has in place a series of programmes in which several countries participate. Spines 2, with the economic support of the European Union, researches into “Sea urchin production in integrated systems, their nutrition and roe enhancement”. This same body also manages MERMAIDS, a work designed to generate a “Multi-trophic culture for environmental remediation – Active management of aquaculture initiatives for diversification and sustainability”.

Lastly, REDWEED is a programme designed to “Reduce the environmental impact of sea-cage farming through cultivation of seaweeds”.

Photo: Steve Cross



Other research groups that have developed lines of action to promote integrated aquaculture include the Research and Development of Coastal Resources and Environments at the Chilean University of Los Lagos, steered by Alejandro Buschmann, and the Environmental Management and Biodiversity Centre at the University of Las Palmas de Gran Canaria.

THE JACUMAR PROJECT

At the scientific meeting held in Porto, one of the works conducted for the National Advisory Board for Mariculture (JACUMAR) was described, namely, “Integrated Aquaculture: pilot experience for multi-

In the photos on the right, mussels produced in the Bay of Fundy, as a culture associated with salmon and macroalgae. On the market, these mussels are certified as coming from sustainable farming. Source: Ministry of Fisheries and Oceans, Canada. www.dfo-mpo.gc.ca



In British Columbia, Canada, Pacific SEA-lab has developed a small-scale industrial installation that is currently researching into the possibilities of combining sablefish, in old cages of salmon, scallop, cockle, sea cucumber and macroalgae, with an intensive IMTA system design. This pilot initiative, also called the Sustainable Ecological Aquaculture System (SEA-System), is supported by an association between industry (Kyuquot Ltd.) and a scientific community devoted to exploring the environmental and socio-economic benefits to do with this type of integrated aquaculture. The promoter of this project, Steve Cross, is acquainted with the works of the scientist, Thierry Chopin, and has applied this experience. Sources: Fish Farming International, April 2010, and www.aquaculture.ca

trophic aquaculture development” (2008-2011)”, Salvador Guerrero, researcher at the Marine Research Centre of the Regional Council of the Rural and Marine Environment of the Regional Government of Galicia (www.cimacoron.org) and Javier Cremades, Professor at the University of A Coruña (www.udc.es), with the collaboration of Juan Manuel Salinas, in charge of the seaweed culture plant at the Spanish Institute of Oceanography of Santander (www.ieo-santander.net). More can be learnt of this project at www.acuiculturaintegrada.com.

The study by Cremades, Guerrero, Salinas and Ancosmede was on “Spores and gametes of green seaweeds as food for bivalves in integrated multi-trophic aquaculture systems”, coordinated by the Marine Research Centre (CIMA) in Vilanova de Arousa. Other sections in this same publication explain the works by these authors in greater detail.

This programme is conducted at the initiative and with the institutional and economic support of the National Advisory Board for Mariculture (JACUMAR), of the Maritime Secretariat General of the Spanish Ministry of Agriculture, Food and Environment (www.magrama.gob.es/es/pesca/participacion-publica/copy_of_default.aspx).

Apart from Galicia, a leading region in marine culture, lines of work have been developed in IMTA systems and practices, by official bodies and scientists in Andalusia, the Balearic Isles, the Canaries, Catalonia and Murcia.

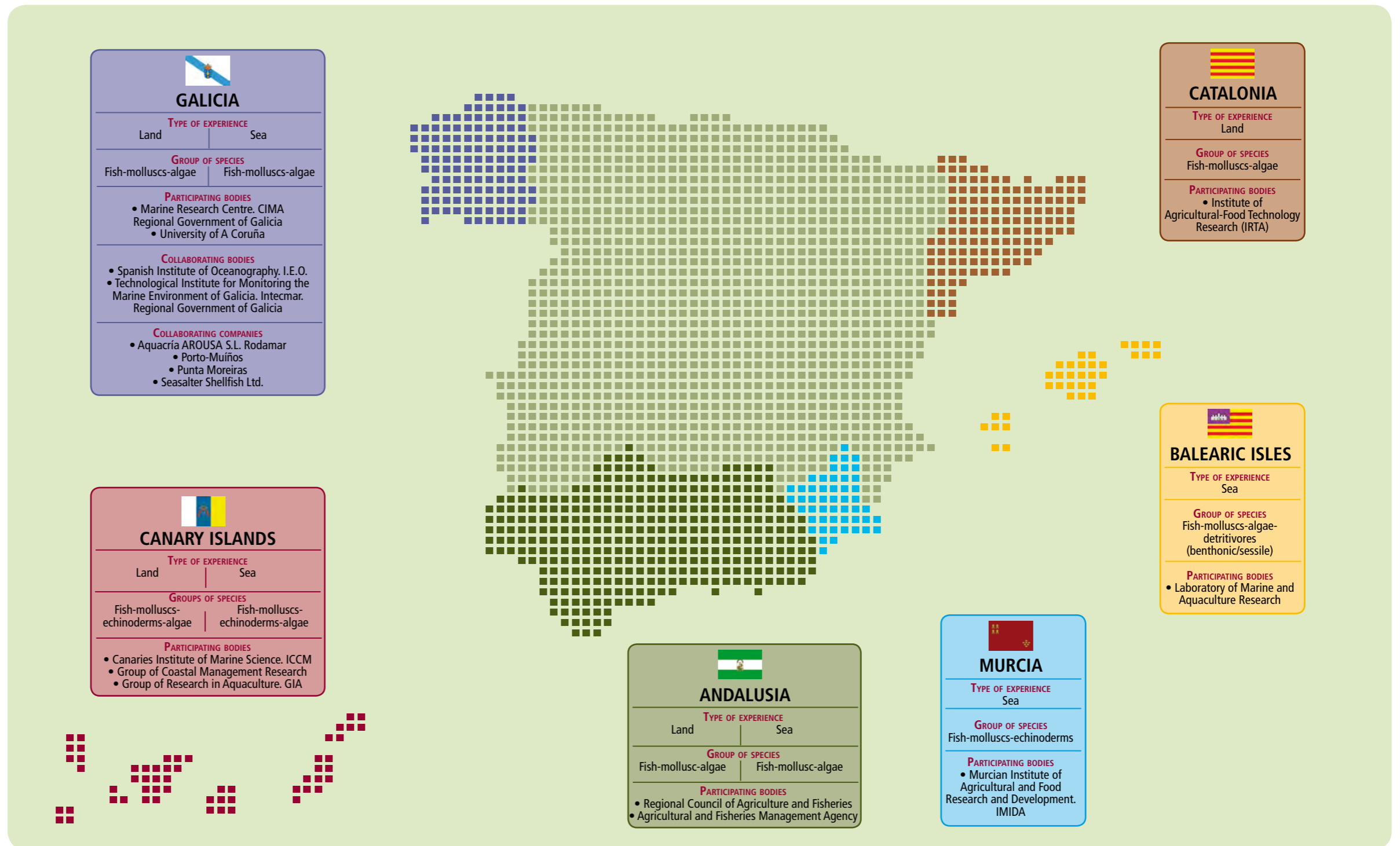



MACROALGAE, EFFICIENT BIOFILTRATORS WITH COMMERCIAL VALUE

By Jorge García (garcia.herosa@gmail.com)

The group of researchers working in Galicia for the JACUMAR programme on multi-trophic cultures considers that the presence of macroalgae in all the combinations of IMTA is one of the main factors that makes aquaculture sustainable, diversified, economically feasible and socially accepted. In the IMTA experiences conducted in this region, species of *Saccharina*, *Codium* and *Ulva* have been farmed in open and closed circuit fish farm effluents, as well as in industrial mussel raft zones in the rias themselves. The data currently being gathered, after over two years of work, by the researchers, Salvador Guerrero (CIMA), Javier Cremades (UDC) and Juan Manuel Salinas (I.E.O., Santander), are positive: the growth and interaction of these species with other cultures of fish and molluscs, and with the environment itself, has generally been developed as forecast in the initial scientific approach drafted by the group.

Specimen of *Laminaria ochroleuca* in the natural environment, among others. Farming laminar seaweed associated with farming fish and molluscs has proved to be efficient.

Practices, previous experiences and available data on algae culture associated with other marine species, in countries with a greater aquaculture production, have helped to adopt some of the main criterion used to first evaluate then convey the first results on IMTA works conducted in Galicia. A growing number of researchers working in marine



Photo: Authors' archives



Photo: Authors' archives

cultures interested in these systems has, over the last few years (2008-2011), been able to draw provisional conclusions in conferences, seminars and congresses held in Spain and other countries.

The good news released at these meetings is that rearing macroalgae with a commercial value has been found to be efficient for remedying the eutrophication produced by fish farming or monoculture. Further good news is that IMTA is viable and necessary in aquaculture along the coastline and in the Galician rias. Also, the culture plant at the I.E.O. in Santander, set up and headed by Salinas, is able to provide macroalgae "seed" for experimental works as well as for taking on industrial scale cultures.

CREATING ECOSYSTEMS

One of the explanations normally given by Cremades in documents regarding production on macroalgae is that there are two main lines of bioremediation to improve the quality of waters where modern aquaculture is present. One of the ways of mitigating eutrophication and, therefore, of reducing a large part of the environmental impact of this type of farming, is by the decomposing activity of bacteria in the formation of gases (N₂ and CO₂). Another way is to promote the assimilating activity of biofiltering organisms and to generate the formation of biomass.

The first of the lines is a bacterial catabolism, very common in fish farms with water recirculation, although its operational effectiveness is technologically complex: it requires oxygenation, elimination of

particulate matter, elimination of ammonium, control of pH, dissipation of any excess CO₂ and disinfection. The costs involved are high since pumps are required to operate the entire system which also builds up nitrate.

The method put forward by Cremades, that has been used in IMTA experiences in Galicia, is biofiltering using photosynthetic plants with an assimilating capacity, such as seaweed. "With solar power and excess nutrients", the expert explains, "particularly C, N and P, seaweed photosynthesize new biomass. By means of this technique, which improves water management, mini-ecosystems are obtained in open and closed circuit fish farming, and also in single culture aquaculture conducted in the marine environment".

BIOFILTERING WITH MACROALGAE

Works carried out in Galicia, Cremades maintains, "confirm that by introducing seaweed as biofilterators in IMTA systems, processes and reduces a substantial part of the overall impact on the ecosystem generated by marine cultures. Furthermore, it also contributes to environmental stability. Seaweed, especially macroalgae, are organisms with a high efficiency for biofiltration as they have the greatest productivity of all plants and can be farmed by methods whose costs are accessible and profitable for industries".

In this manner, scientists share the generalized criterion that working in IMTA, in terms of integrated aquaculture, the nutrients



Photo: Authors' archives

Top and left, Cremades (UDC), with *Saccharina latissima* farmed in an IMTA system in Galicia. Next to him, Salinas (I.E.O.) with the same species farmed in a tank. Below, Guerrero (C.I.M.A.) observing a culture of *Gracilariopsis longissima* in a tank.



Photo: Authors' archives

A farmed specimen of laminar algae in the sea, at the Galician company, Porto-Muiños, with an industrial application, using a system of ropes and floats known as longline.

In the top photo, a free-living culture of *Saccharina latissima* gametophytes at the I.E.O. Algae plant in Santander. Below, pre-culture of sporophyte young of this same species at the CIMA installations for use in different multi-trophic farming experiences.

Photo: Authors' archives



arising from rearing fish should not be considered as waste, but rather as a resource for farming seaweed with a commercial value, and also as food for molluscs of the genus *Haliotis* – known as abalone, shrimps and sea urchins, inter alia.

The aquaculture industry, in several countries, uses the know-how built up by the experiences and applications of IMTA, carried out over more than twenty years, to form efficient, specific designs involving integrated cultures, both on land and at sea. These often integrate fish, filtering molluscs, phytoplankton and macroalgae biomass production.

One of the main advantages of using macroalgae as biofilters, in relation to other systems, is that it produces a “sequestration” of the nutrients present in the water, in such a manner and to such an extent that it makes it possible to quickly recirculate the effluent from a fish farm or to discharge it into the marine environment.

Other data from the works carried out in Galicia indicate that in a recirculation system, each kilogramme of *Ulva* in the stock produces sufficient oxygen per day to meet the demand of two kilogrammes of fish in the stock.

It should be noted, in this same regard, that “consumption of nocturnal oxygen from macroalgae is far lower than daily production. In some species, it has been estimated that 12 times more oxygen is produced than is consumed by their breathing”.

SELECTION CRITERION

IMTA researchers in Galicia have drafted a series of criterion to select species of seaweed with an efficient behaviour in an integrated system. Some of the factors to be evaluated are:

- High growth and concentration rate of nitrogen in their tissues
- Ease with which their life cycle can be reared and monitored
- Resistance to epiphytes and diseases
- Coinciding ecophysiological requirements with those of the system
- Being a local or previously introduced species
- Commercial value of the production

These criterion have been defined in terms of the fact that one of the first requirements put forward when designing IMTA is bioremediation. In this case, the uptake and build up of nutrients, in addition to the growth rate, are determining factors. Needless to say, it is considered that the optimum way is to identify a species that combines commercial value with bioremediation capacity.

As regards this aspect, growth rate is also related to morphology. In other words, there is a direct relationship between greater surface area/volume (AV), of alga thallus with the highest growth rates. Macroalgae with a filamentous or laminar morphology will have a higher growth rate than one with a thick, fleshy morphology. As regards species with a complex morphological structure, as can be the case in the kelp species, it is also very important to evaluate the age of the plant.

Photo: Authors' archives



Other stages of growth of *Saccharina latissima* already in multi-trophic culture tanks. Below, specimen of *Ulva australis*, one of the species that has also been used in these experiences.

Photo: Authors' archives



Photo: Authors' archives



THE BEST CANDIDATES

When considering a species of seaweed to use as a biofilter, it should be taken into account that it will have to grow well in high concentrations of nutrients, particularly ammonium. Other seaweed that do not have this capacity, such as the *Chondrus crispus*, which prefer nitrate to ammonium, have a more limited use. In the short list of macroalgae species that have been researched as biofilters are the *Ulva*, this being the most studied species, as well as the *Gracilaria*. *Ulva* has many of the basic conditions required to be a part of an IMTA system: it forms lamellar, has a high rate of growth and nitrogen concentration, and is also able to grow in high concentrations of ammonium. Moreover, its life cycle is known and controllable. The disadvantage ascribed to the industrial use of *Ulva* in biofiltration is, for the time being, the limited value attained by production on the markets.

The most suitable species for IMTA systems, for their biofiltering capacity, combined with their commercial value, are: top and on this page, *Porphyra*. Below, from the left, *Saccharina latissima*, *Ulva* spp., *Gracilaria* spp. and *Palmaria palmate*, among others.

Photo: Authors' archives



The *Porphyra* species (the nori seaweed in sushi) are appropriate as they have the characteristics of *Ulva* and have a high commercial value in the food market. The handicap with the *Porphyra* species is that, in an integrated aquaculture system, it is not possible at present to control their life cycle in order to keep up a purely plant culture throughout the year.

Photo: Authors' archives



Farming techniques for the species of *Gracilaria* and *Chondrus* have been studied and are well known. For this reason, it is possible to control their growth. Some

Top, *Saccharina latissima* in the natural environment, along with *Ulva rigida* and other species.

of their advantages are that they take in nutrients and that it is possible to extract phycocolloids to form gels, viscous substances and suspension stabilizers. The food industry uses them to produce agar, alginates and carrageenan seaweeds. But however, it should be noted that their growth rates, due to their morphologies, are significantly lower than in the species mentioned earlier. It should also be noted that the market for products processed with phycocolloids shows a downhill trend.

One of the most promising candidates for use in IMTA as biofilters in cold waters, such as the case of the coasts and rias of Galicia are the laminars, especially species of *Saccharina* (sugar kelp), *Laminaria* and *Macrocystis* (kelp), which have been researched in Canada, Spain, Germany, Scotland and Chile, and are produced by the fishfarm industry.

Photo: Authors' archives



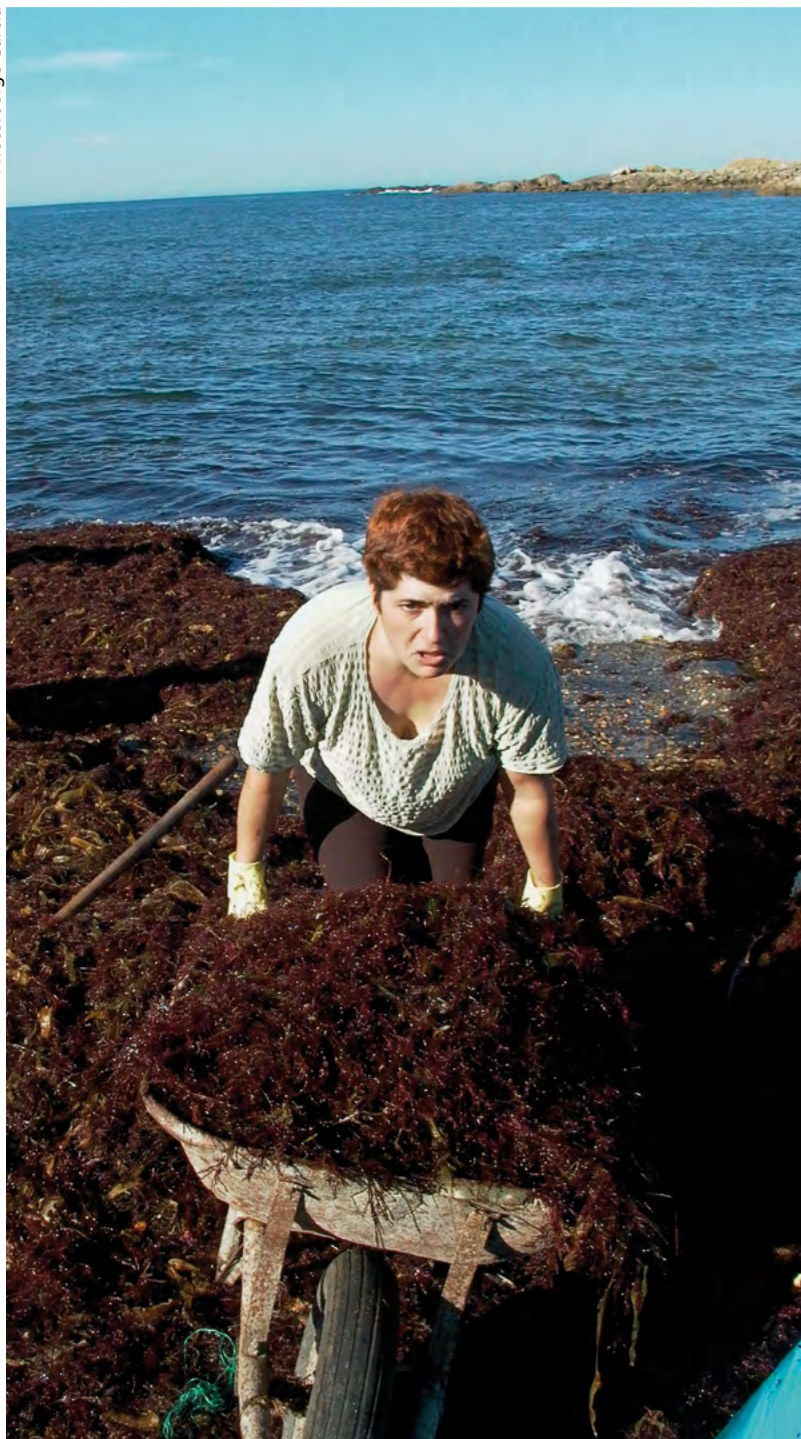

NEW PRODUCTS, NEW MARKETS

Industrial aquaculture managers are aware of the prolonged, complex actions that need to be taken so that a new product manages to have a leading position in the competitive world of food, which is one of the traditional markets for some of the commercial presentations of seaweed. On the other hand, for the pharmacological and cosmetics industries, seaweed are raw material whose properties are continually being researched, which leads to creating new end uses and generates demand for some species.

For these and other reasons, the criterion of commercial value in this field should be approached strategically and as a highly diverse concept that is evolving at a fast pace. Nevertheless, one of the competitive advantages that seaweed farmers share with other products in aquaculture is that they can guarantee the processing industries a constant supply of raw material, in terms of quantity, quality and, as a result, in price. Added to this is the contribution of proteins and other health benefits, which means consumption of foods processed with seaweed for in food for humans.

Apart from their uses in catering and the food, pharmacological and cosmetics industries, research has begun on seaweed, with some promising results as a component of animal feed, particularly for fish. In Portugal, experiences have been conducted on tilapia and trout, and in Galicia, experiences are underway with sole. It has been objectively established that the presence of algae in feed increases the composition

of fatty acids while giving a pleasant taste for fish during rearing, apart from having a higher content in amino acids than in traditional soya fishmeals that are normally used in feed.

In the field of alternative fuels made with non-renewable raw materials, experiment work has also been conducted with certain species. Cremades states that, in Galicia, at least 20 autochthonous species of algae with commercial value are found, many of which are already collected or produced.

Farming algae for IMTA is a guarantee of efficient bioremediation and, therefore, to a large extent it collaborates in reducing the impact of other cultures in the aquatic medium. Its industrial feasibility is backed by consolidated groups of research that actively exchange information.

In this regard, it should be recalled that



On the previous page, a harvester of *Gelidium corneum* seaweed, on the Galician coastline, used by the phycocolloid industry. On this page and at the top, Guerrero, Sergio Devesa, Technical Director of Aquacría, and Salinas, at the seaweed culture plant in El Bocal, Santander. Below, fried sea lettuce with crème pâtissière and cherries. This recipe is by the chef, Gonzalo Rey, at the Agar-Agar restaurant, made on the course "preparing seaweed" at the Porto-Muiños Cooking School (www.portomuiños.com).



in June 2011, in Vigo, the Technological Maritime Centre, the CETMAR Foundation, an official body of the Regional Government of Galicia, organized a seminar on macroalgae with the collaboration of Iberomare, a cross-border project under the Inter-regional Spain-Portugal community programme, whose work is orientated towards evaluating aquaculture sub-products. At this seminar, researchers from Portugal, Galicia, Malaga, Santander and Las Palmas were able to exchange experiences and get up to date on their know-how of the "Application of macroalgae in purifying effluents from aquaculture. IMTA systems".

Lastly, mention should be made of the fact that these and other meetings of the kind have highlighted the interest in integrated aquaculture, but also the need that the important effort made by researchers following this line to be done with interdisciplinary teams, able to design economic models for investment, management and for access to markets with new products deriving from IMTA, especially those from macroalgae farming. And all this to make projects in this matter more realistic and feasible.



Dr. Thierry Chopin, well-known seaweed expert, and Scientific Director of the Canadian Integrated Multi-Trophic Aquaculture Network (CIMTAN) www.unbsj.ca/sase/biology/chopinlab/index.html.

DR. THIERRY CHOPIN PROPOSES AN EVOLUTION TOWARDS MORE ECOSYSTEM RESPONSIBLE AQUACULTURE SYSTEMS

“IMTA is the general concept, but like in Bach’s music, there are themes and many variations”

The French-born scientist, who emigrated to Canada in 1989, is considered by many to be one of the key leaders in the development of Integrated Multi-Trophic Aquaculture

By Jorge García (garcia.herosa@gmail.com)

Dr. Thierry Chopin, Professor of marine biology at the University of New Brunswick in Saint John, Canada, was born and educated in France, where he obtained his PhD at the University of Western Brittany, in Brest. Chopin now leads a team of scientists of various disciplines specialized in IMTA: “We are at the leading edge in the development of new sustainable practices for commercial aquaculture and we have acquired a worldwide reputation thanks to the work of the whole team”, the researcher commented recently. The criteria, practices and systems of IMTA, being adopted by the aquaculture

industry in several countries and examined in others, originate from the work of the team led by Chopin. In this interview, the scientist reflects, suggests and also brings in data and experiences to explain the environmental, economic and societal benefits of integrating farming at different trophic levels. About the place where he lives in Canada, Chopin said: “Being in a multi-cultural community like ours is interesting, particularly when one tries to understand cultures rather than judge them. Saint John is changing and this multi-ethnic personality gives rise to a new momentum to the city”.

• **The Spanish aquaculture industry has a high level of development, especially along the Galician coast. What is your view about the IMTA prospects for mussels, cockles, clams and oysters, as well as turbot and sole?** *Thierry Chopin: My view is that the Galician aquaculture has a highly developed mollusc industry. For instance, on Google Earth it is very easy to spot all those rafts (bateas)... The idea of introducing some diversification would be interesting from an environmental, economic and societal perspective. Broadly speaking,*

The farms are under pressure to improve their efficiency, but the industry sustainability must also improve

it can be said that for independent farmers, in a market that has become global and concentrated, and in places where there is public participation in the creation of policies, the survival of the activity needs the adoption of some competitive advantages and some diversification. The farms are under pressure to improve their efficiency, but the industry sustainability must also improve. We are working on that in New Brunswick, on the East coast of Canada, where there is a predominance of salmon farming. IMTA allows this diversification.

• **What can we learn from your experience?**

The worldwide expansion of Atlantic salmon, *Salmo salar*, farming has been considerable over the last three decades. The option we are proposing to the farmers is to associate salmon farming with that of other species and in proximity. In the Bay of Fundy, and within the framework of an industrial pilot project, the brown seaweeds, *Saccharina latissima* and *Alaria esculenta*, the blue mussel, *Mytilus edulis*, and salmon, *Salmo salar*, are farmed together. When we compare with reference sites, the growth rate increased by 46% in macroalgae and up to 50% in mussels grown near fish farms, which we think is a reflection of the increase in the availability of food and energy. None of the therapeutic products that can be used in salmon farming have been detected in either the algae or the

An Integrated Multi-Trophic Aquaculture (IMTA) site of Cooke Aquaculture Inc. in the Bay of Fundy, Canada: salmon cages on the left, a mussel raft in the right foreground and a seaweed raft in the right background.

mussels harvested at the IMTA sites, for eight years. The heavy metal, arsenic, polychlorinated biphenyls and pesticides levels have always been below the regulatory limits of Canada, the USA and the European Union. All these biological results, thus, support the adoption of IMTA systems.

• **Who are your industrial partners?**

Collaborating with industrial partners is very important for the progress of such large projects. Cooke Aquaculture Inc. (www.cookeaqua.com) has been our key partner for several years. Fisheries and Oceans Canada, the Canadian Food Inspection Agency, Environment Canada and the New Brunswick Department of Agriculture, Aquaculture and Fisheries have also been very important collaborators. We should also not forget the

funding agencies which have allowed the research to continue uninterrupted for 10 years now. The key ones are the Natural Sciences and Engineering Research Council of Canada, the Atlantic Canada Opportunities Agency, Fisheries and Oceans Canada and the New Brunswick Innovation Foundation.

• **Which of the know-how transfer experiences from IMTA research and development to the aquaculture industry may turn out to be useful?**

It is necessary that the researchers talk to the industry, the regulatory agencies, the environmental NGOs and the public at large to know what the issues are and how these can be addressed with solutions such as IMTA. It is, however, clear that there is no magic bullet reached after only a few years. Things take time, this is a fact and it should be recognized. I like to remind people that IMTA is the over-arching concept, but like in the music of Johann Sebastian Bach, there are themes and many variations. IMTA is the overall theme, then it must be adapted to the local conditions and situations, which is where variations arise. Thus, it depends on you to define which type of IMTA is best suited for your region, but an important recommendation is that the focus must, definitely, be on integration and interdisciplinarity. The solutions are often at the interfaces of disciplines.

• **Are there some models more successful than others regarding species produced and in what proportion?** Again, I have to answer that it depends on your region, your environmental conditions and your economic and social situations. This is not to avoid

It is necessary that the researchers talk to the industry, the regulatory agencies, the environmental NGOs and the public at large

the question, but it is important to develop solutions adapted to where you are and based on a thorough knowledge and understanding at many different levels. I don't know enough about your region to provide a solid advice. Which species are used and why? There is a lot of documentation about the criteria to select appropriate species. As a guidance, from a review we wrote for the FAO a few years ago, the genera with most potential for the development of IMTA systems are generally the following:

MACROALGAE:

Laminaria, Saccharina, Sacchoriza, Undaria, Alaria, Ecklonia, Lessonia, Durvillaea, Macrocystis, Gigartina, Sarcothalia, Chondracanthus, Callophyllis, Gracilaria, Gracilariopsis, Porphyra, Chondrus, Palmaria, Asparagopsis and Ulva

MOLLUSCS:

Haliotis, Crassostrea, Pecten, Argopecten, Placopecten, Mytilus, Choromytilus and Tapes

ECHINODERMS:

Strongylocentrotus, Paracentrotus, Psammechinus, Loxechinus, Cucumaria, Holothuria, Stichopus, Parastichopus, Apostichopus and Athyonidium

POLYCHAETES:

Nereis, Arenicola, Glycera and Sabella

CRUSTACEANS:

Penaeus and Homarus

FISH:

Salmo, Oncorhynchus, Scophthalmus, Dicentrarchus, Gadus, Anoplopoma, Hippoglossus, Melanogrammus, Paralichthys, Pseudopleuronectes and Mugil



Photo: Thierry Chopin



Photo: Esther Tremblay-Deveau



• **What criteria have been used to make this selection?** *These genera have been selected because of their farming techniques, right habitat, bio-mitigation abilities and finally their economic value. For each region where IMTA can be developed, it is important to select the species appropriate for the habitat, the environment, their complementary functions in the ecosystem and the socio-economic situation.*

Researchers need to disseminate their knowledge to various audiences. Increasing the awareness of IMTA will certainly be an important task. Top: 2nd annual meeting of CIMTAN; bottom: field trip during the annual Festival of Nature organized by the New Brunswick Federation of Naturalists.

• **Are there IMTA criteria for open ocean aquaculture?** *As a result of the rising seafood demand, some foresee an expansion towards open ocean locations. The availability of new sites, protected and near the coast, is becoming limited. The move towards open waters is also considered a way to decrease some environmental problems. However, the development in more exposed areas will also have its limitations. It is very likely that farms in the future will be bigger than the existing coastal ones. Thus, they will also generate higher levels of wastes. We should not think that in oceanic environments the hydrodynamic conditions will allow dispersion and thus the environmental impacts will be lower; we should also think of recapturing this food and energy, which would otherwise be lost, with extractive species. From the beginning, we should think of having efficient ocean IMTA systems, also performing their biomitigative functions; it should not be an afterthought for 2050! Anyway, we know that there will be many challenges to overcome in the biological, environmental, engineering, technological, economic, legal, regulatory and societal domains.*

• **Are the EU agencies aware of IMTA, as a sustainable strategy for aquaculture and product diversification?** *I have been living in Canada for the last 22 years and I do not know the present EU programs and procedures. I am aware of a few IMTA projects in the EU, but are the regulators, decision makers and politicians sufficiently aware of the possibilities of IMTA? I doubt this is the case, but this is not unique to the EU! Increasing the awareness of IMTA will certainly be an important task.*

• **Are economic considerations useful for the aquaculture industry to embark on IMTA farming?** *The existing IMTA bio-economic models have shown that economic stability, generated by the diversification of products and risk reduction, is key to remain in business and increase profits. Furthermore, if the biomitigative services of IMTA were properly estimated and were part of business plans, they would represent financial incentive tools to encourage mono-aquaculturists to contemplate IMTA as a viable marine agronomy option to their current practices.*

• **How does IMTA relate sustainability to profits for the aquaculture industry?** *Establishing sound biological principles is important for a business to be sustainable. However, sustainability also needs to be measured at the economic and societal levels. An aquaculture operation must be economically viable without being too risky. In addition, public opinion is important because consumer's perceptions have an influence on products' demand and prices and, hence,*

We know that there will be many challenges to overcome in the biological, environmental, engineering, technological, economic, legal, regulatory and societal domains

From the rope to the plate: IMTA practices should help differentiate high-quality and high-value IMTA products. Left: a line of the cultivated kelp, *Alaria esculenta*, in Back Bay, New Brunswick; right: a delicious IMTA kelp (*Saccharina latissima*) wrap prepared by Chris Aerni, Chef and owner of the Rossmount Inn in St. Andrews, New Brunswick.

on the development of the industry. We have demonstrated that, over 10 years, the loss of one fish harvest induces losses for a fish monoculture operation, while an IMTA operation would still be profitable.

• **Has the IMTA's social responsiveness been estimated as an alternative to monoculture?** *We have carried out several attitudinal surveys both in Canada and the USA. They showed that perceptions towards IMTA are more favourable than towards monoculture. The surveyed people related the success of aquaculture to sustainability. It was also emphasized that farming high quality products, without harming the environment, was key to a successful aquaculture industry and to improving people's perceptions. All the participants agreed that food produced by IMTA systems is safe to eat and 50% of the participants were ready to pay 10% more for these products, if they were labelled as such in stores. This opens the door for eco-labelling, or eco-certification, and differentiation of IMTA products commanding a premium market price.*

Photo: Thierry Chopin



Photo: Thierry Chopin



IMTA EXPERIENCES IN GALICIA

Lorbé (Ría de Ares and Betanzos. A Coruña).

Experience at sea

Floating mussel beds / Food Macroalgae

(*Saccharina latissima*)

CIMA, UDC, IEO Santander

Conservas PORTO-MUIÑOS

Esteiro (Ría de Muros y Noia. A Coruña).

Experience at sea

Fish cages (turbot) / Food macroalgae

(*Saccharina latissima*)

CIMA, UDC, IEO Santander

MARCULTURA S.L.

Cambados (Ría de Arousa. Pontevedra).

Experience on land. Closed circuit

Fish (turbot and sole) / Suspensivore invertebrates (anemones and polychaetes)

/ Filtering molluscs (clams and oyster)

/ Food macroalgae (*Saccharina latissima*)

CIMA, UDC, IEO Santander

AQUACRIA S.L.

O Grove (Ría de Arousa. Pontevedra).

Experience on land. Closed circuit

Fish (turbot) / Suspensivore invertebrates (anemones) / Filtering molluscs (clams and oyster)

/ Food macroalgae (*Ulva* and *Saccharina latissima*)

CIMA, UDC, IEO Santander

PUNTA MOREIRAS S.L., INTECMAR

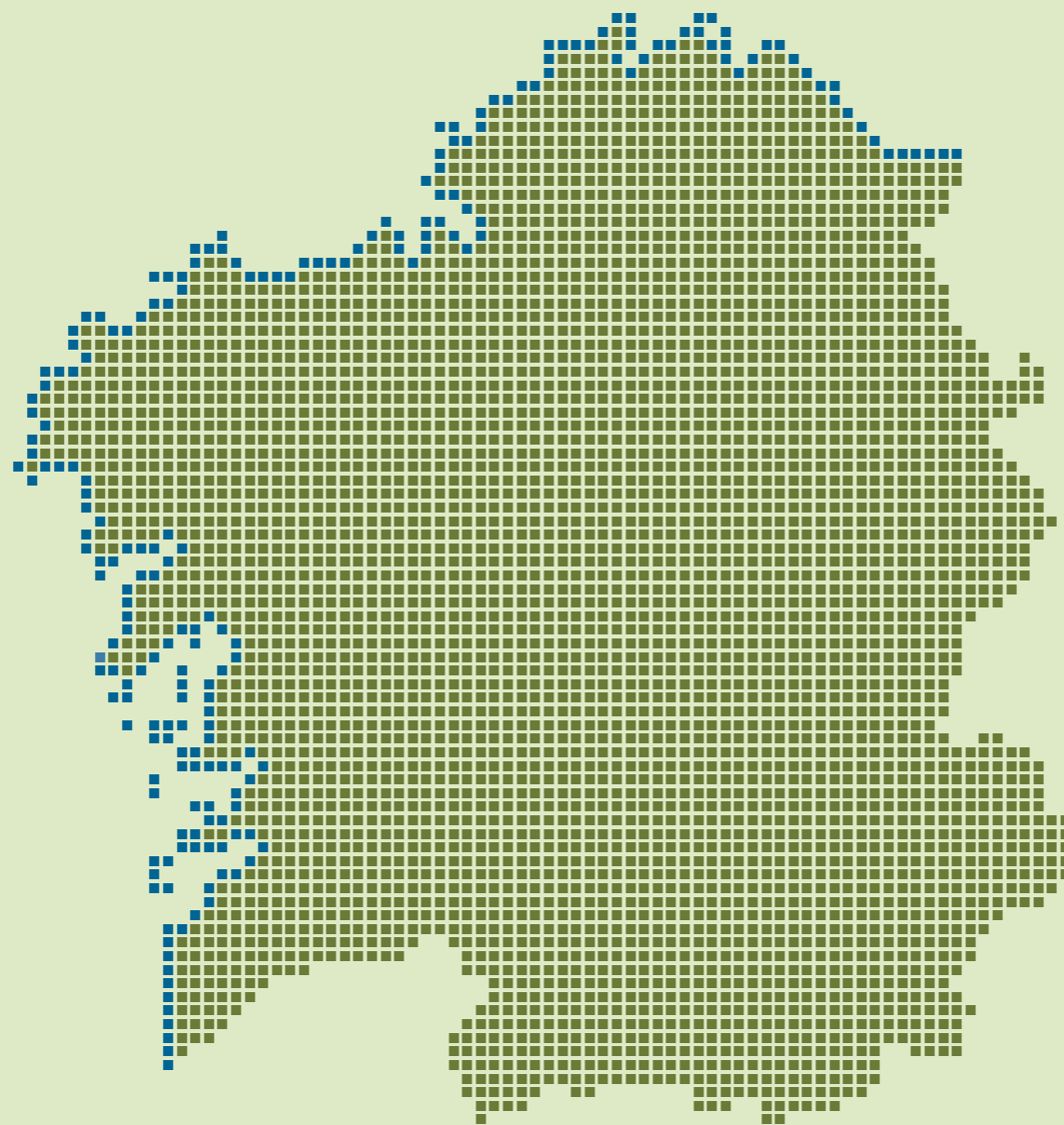

RESEARCH BODIES AND THE PRIVATE SECTOR TAKE PART IN EXPERIENCES WITH INTEGRATED AQUACULTURE IN GALICIA

Designing and conducting IMTA experiences in Galicia for the JACUMAR programme involved the participation of the CIMA, the University of A Coruña, the I.E.O. of Santander and the Technological Institute for Marine Environment Control, INTECMAR, a body of the Regional Government of Galicia, which provided biochemical and oceanographic data on the rias of Arousa, Muros-Noia and Ares-Betanzos. The tasks were conducted in installations at sea and in open and closed circuit fishfarms, with the collaboration of private sector aquaculture companies.

“Seaweed seeds” for experiences at sea were provided by the germoplasm bank at the I.E.O. Santander seaweed culture plant, with stock from autochthonous populations from the Galician coast. Molluscs and invertebrates are from various farms on the Galician coast. Species are selected for rearing in the experiences in terms of their commercial value for human consumption, for the pharmacological and cosmetics industries or for their possible uses in the agricultural/livestock or energy sectors. The first stages of farming were conducted at the CIMA installations in Vilanova de Arousa and, where applicable, were subsequently transferred to installations on land and in the marine environment.



Integrated farming of macroalgae in fish cages in the ria of Muros and Noia (A Coruña)

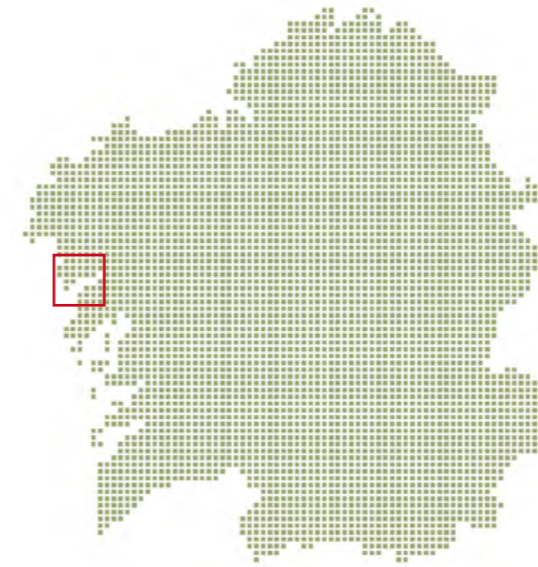

Location of the fish cages where the experiences were conducted in the Esteiro bay (ria of Muros and Noia, A Coruña). Photos from Google Maps and ortophotos from the SigPac visor of the Ministry of Agriculture, Food and Environment.

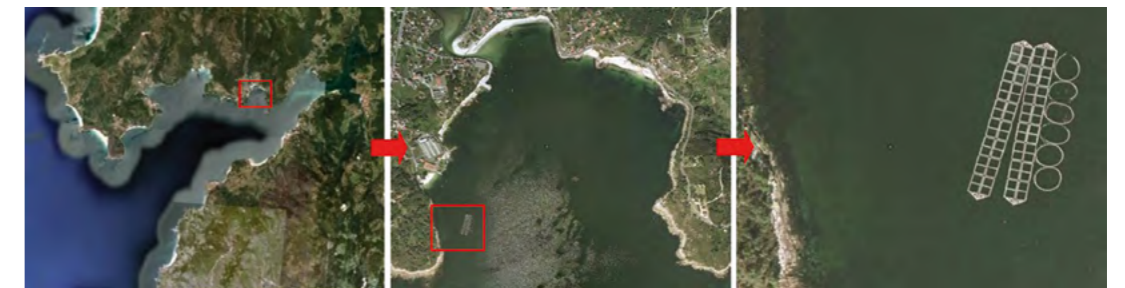

The experience described here involves evaluating the possible advantages and disadvantages of integrating cultures of marine macroalgae and fish. The initial hypothesis is that such integration, on the

one hand, may increase the production of both cultures while improving the quality of the water, both for reducing eutrophication and dissolved CO₂. Furthermore, it fosters diversification of Galicia aquaculture.

Diagram: Javier Cremades

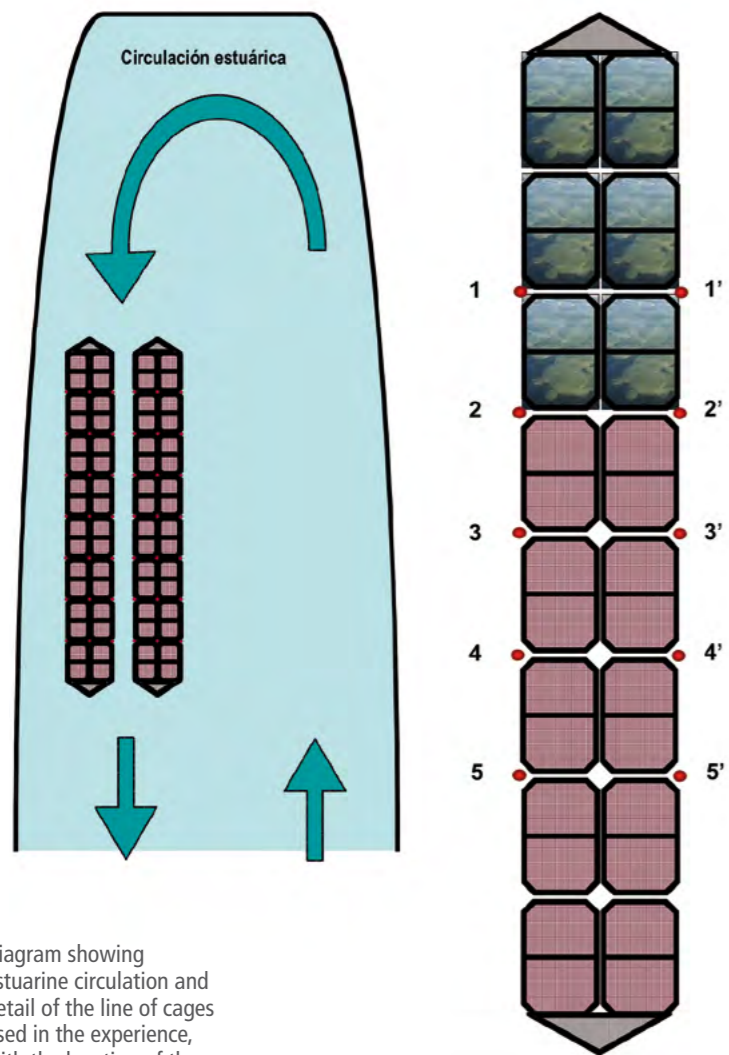

Diagram showing estuarine circulation and detail of the line of cages used in the experience, with the location of the fish and points where the lines were placed for farming macroalgae.

DESCRIPTION OF THE EXPERIENCE

The experience was conducted in the fish rearing cages owned by the collaborating company, MARCULTURA, S.A., located at Somorto, Esteiro, in the ria of Muros and Noia (A Coruña).

The installation comprised 8 square floating cages joined together and arranged in line. The first three cages contained ongrowing turbot throughout the experiment, whereas the other 5 were empty. The seaweed culture lines were set vertically at the joining points between the cages and on both sides of the same (points 1 to 5).

The species of macroalgae farmed was *Saccharina latissima* (Linnaeus) Lane, Mayes, Druehl & Saunders (Laminars, Phaeophyta), known as "sugar kelp". This species, autochthonous to the northwest of the Iberian Peninsula, can be the raw material for obtaining alginates and biogas. But however, it has a greater added value when used for animal and human food.

Saccharina latissima seed was produced at the Algae Culture Plant of the I.E.O. in Santander, using its germoplasm bank, applying the free-living technique (Pérez *et al.*, 1992). Seeding was performed on 20th November 2008. The method of seeding used was also the one known as the Japanese method. Here, the seeding strings were cut into 5 cm long fragments, which were placed every 10 cm along the culture line.

In order to follow the variations in the environmental conditions throughout the experience, a light intensity and temperature sensor was attached.

Final sampling of the seaweed culture was conducted on 6th April, 2009, 137 days after being immersed in the sea. At all the points where lines with *Saccharina* were arranged,

Photo: Authors' archives

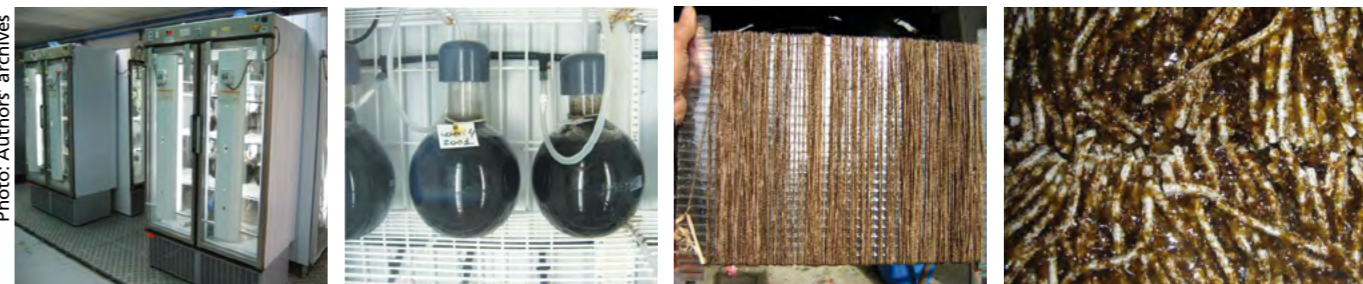
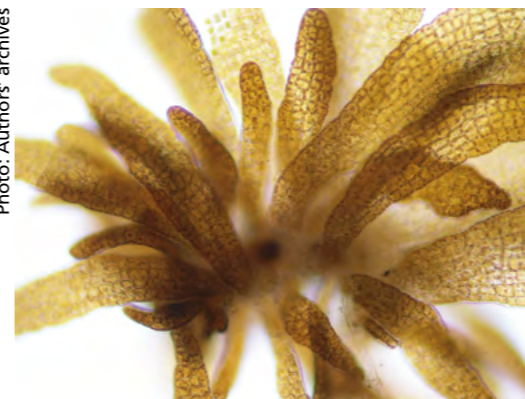

Photo: Authors' archives



Top, production stages of the "seed" of *Saccharina latissima*. Chambers of germoplasm with flasks of free-living gametophyte culture, collector with a line of seed and fragments of the same ready for seeding, following the Japanese method. To the left, young sporophytes of *S. latissima*, as they are viewed under the microscope.

Photo: Authors' archives



species biomass was estimated per metre of line and samples were taken to analyse the percentage of C, N and for the $\delta^{15}N$. These analyses will allow us to evaluate to what extent the algae have accessed the sources of nitrogen arising from fish metabolism, (Holmer *et al.*, 2008) or, in other words, the amount of forms of nitrogen of animal or anthropic origin that the algae are biofiltering from the waters.

RESULTS AND DISCUSSION

Average production figures for *Saccharina latissima* fluctuated between 7.1 and 10.7 kg/m, so that they lie within the interval of values obtained in other experiences conducted in Galicia. They are below those of 13.1 kg/m obtained by Cremades *et al.* (2007), also using vertical lines at a distance

To the right, general aspect of the cage lines and detail of those that were occupied by turbot during the experiences.

Photo: Authors' archives

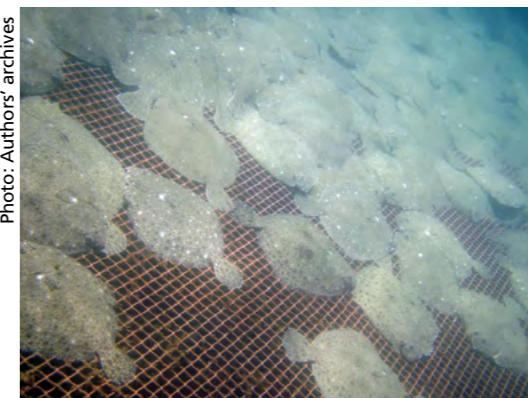



Photo: Authors' archives

from other aquaculture structures, but higher than those of 6.2 kg/m obtained by Peteiro *et al.* (2006) on longline.

Although there are no significant differences between the lines, at least in the time period and density of macroalgae culture tested, the proximity to the fish is not beneficial since the nearest algae to them and which, furthermore, presented the greater ratio $\delta^{15}N$ (6.25), i.e., that they were the only ones that accessed the ammonium excreted by the fish as an additional source of nitrogen, attained smaller sizes and production figures per metre of culture out of the entire experiment.

The explanation for this small detriment in production, although not statistically significant due to the high variability in biomass of the different implants, could be explained by the lower light incidence on these lines due to shadowing and a greater degree of turbidity of the waters close to the cages occupied by the fish as opposed to the cages

Recently seeded lines (20/11/2008) and detail of the implants after the first month of growth (15/12/2008).

Development of the average biomass of *Saccharina latissima* and the isotopic ratio of nitrogen in terms of the distance to the fish.

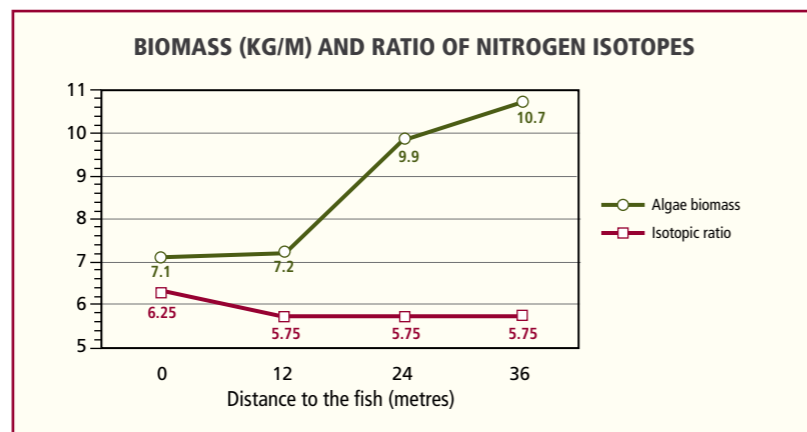

Photo: Authors' archives

that were empty since, according to Cremades *et al.* (2007), variations of this factor can lead to important reductions in production.

In view of the results obtained, it seems clear that the main cause for the apparent absence of a net advantage in integrating macroalgae with fish that was obtained in this experiment arises from the fact that, with the density of culture tested, throughout its duration and in all zones of the same, the nutrients should



Photo: Authors' archives

not, in any of the case, be a limiting factor for the development of *Saccharina latissima*.

We may conclude, therefore, that in the multi-trophic fish-algae aquaculture techniques in the Galician rias, it is preferable to have a mosaic-shaped distribution as opposed to a mixture of both cultures, which has important implications when it comes to future coastal ordinance of aquaculture production.

Due to the high level of nutrients in the Galician rias, the benefit of integration fish-macroalgae cultures does not bear a direct relationship to the proximity between them, and it even may become a handicap, since the nearby presence of fish and of submerged structures reduces light radiation while exacerbating sedimentation and recruitment processes that may lead to a considerable increase in fouling, one of the main problems of macroalgae cultures. We may also conclude that the benefit of these polycultures should be evaluated both in

Appearance of a line after three months of culture (16/02/2009). To the right, one of the implants with most growth, obtained in the final sampling (6/04/2009).



Photo: Authors' archives

terms of the improvement in quality of the marine environment and the increase and diversification of total aquaculture production.

REFERENCES

Cremades J., Freire O., Baamonde S., Salinas J.M. & Fuertes C. (2007) Nuevo método para el cultivo industrial de *Laminaria saccharina* (Laminariales, Phaeophyta) en las costas gallegas. Actas XI Congreso Nacional de Acuicultura, 1: 559-562.

Holmer M., Hansen P.K., Karakassis I., Borg J.A. & Schembri P.J. (2008) Monitoring of environmental impacts of marine aquaculture. En: (Eds.), Aquaculture in the Ecosystem. Holmer M., Black K., Duarte C.M., Marbà N. & Karakassis I. Springer, pp. 47-85.

Pérez R., Kaas R., Campello F., Arbault S. & Babaroux O. (1992) *La culture des algues marines dans le monde*. Service de la Documentation et des Publications (SDP). IFREMER. Plouzane.

Peteiro C., Salinas J.M., Freire O & Fuertes C. (2006) Cultivation of the autoctonomous seaweed *Laminaria saccharina* on the Galician Coast NW Spain): Production and features of the sporophytes for an annual and biennial harvest. *Thalassas*, 22: 45-53.



Open sea farming of the food seaweed *Saccharina latissima* associated with floating mussel beds in the rias of Ares and Betanzos (A Coruña)

This experience was conducted from December 2009 to April 2010, in the experimental administrative concession for developing marine macroalgae cultures of which the collaborating company, Porto-Muiños, is a beneficiary, located in the Sada II marine culture Complex, in the Ria of Ares

y Betanzos (A Coruña). The basic hypothesis is that this integration of these cultures will bring benefits such as an improvement in the quality of the water due to the reduction of eutrophication and of dissolved CO₂ values as well as an increase and diversification of aquaculture production in the complex.

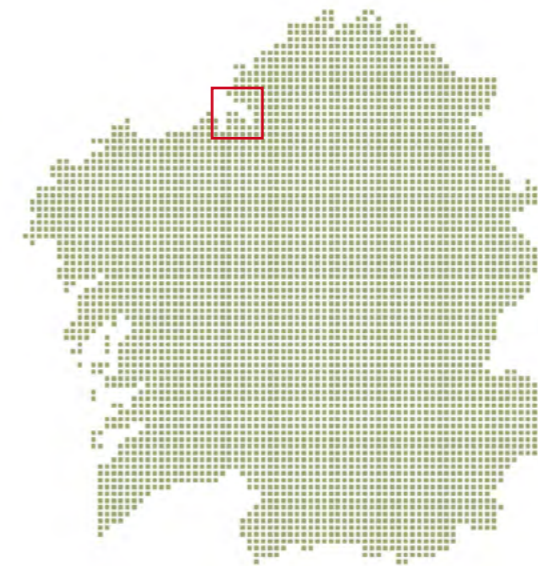

Sada II marine culture complex in the Ria of Ares y Betanzos (A Coruña), where the experience was conducted. Images courtesy of Google Maps and orthophotos from the SigPac viewer of the Ministry of Agriculture, Food and Environment.



DESCRIPTION OF THE EXPERIENCE

As in the previous experience, farmed *Saccharina latissima* seed was produced at the Algae Culture Plant of the I.E.O. in Santander, using its germoplasm bank and the free-living technique (Pérez *et al.*, 1992).

Seeding was conducted on 18/12/2009 using the so-called Japanese method. This involves the threads of seed being cut into fragments of around 5 cm in length, which are inserted every 10-15 cm, after opening it, inside the end of the culture. This species was farmed by using a system of double floating lines joined together and refloats with 100 litre transversal buoys arranged every 5 metres. Each line, between the transversal buoys, has a further 5 buoys of 3 litres each, from which the culture lines are hung (Cremades *et al.*, 2007).

Follow-up of the experience involved making regular samplings and growth rates were estimated following the various samplings and in the various locations. Likewise, analysis of the $\delta^{15}N$ determined in the algae samples

Photo: Authors' archives



Photo: Authors' archives



Photo: Authors' archives



Diagram: Javier Cremades

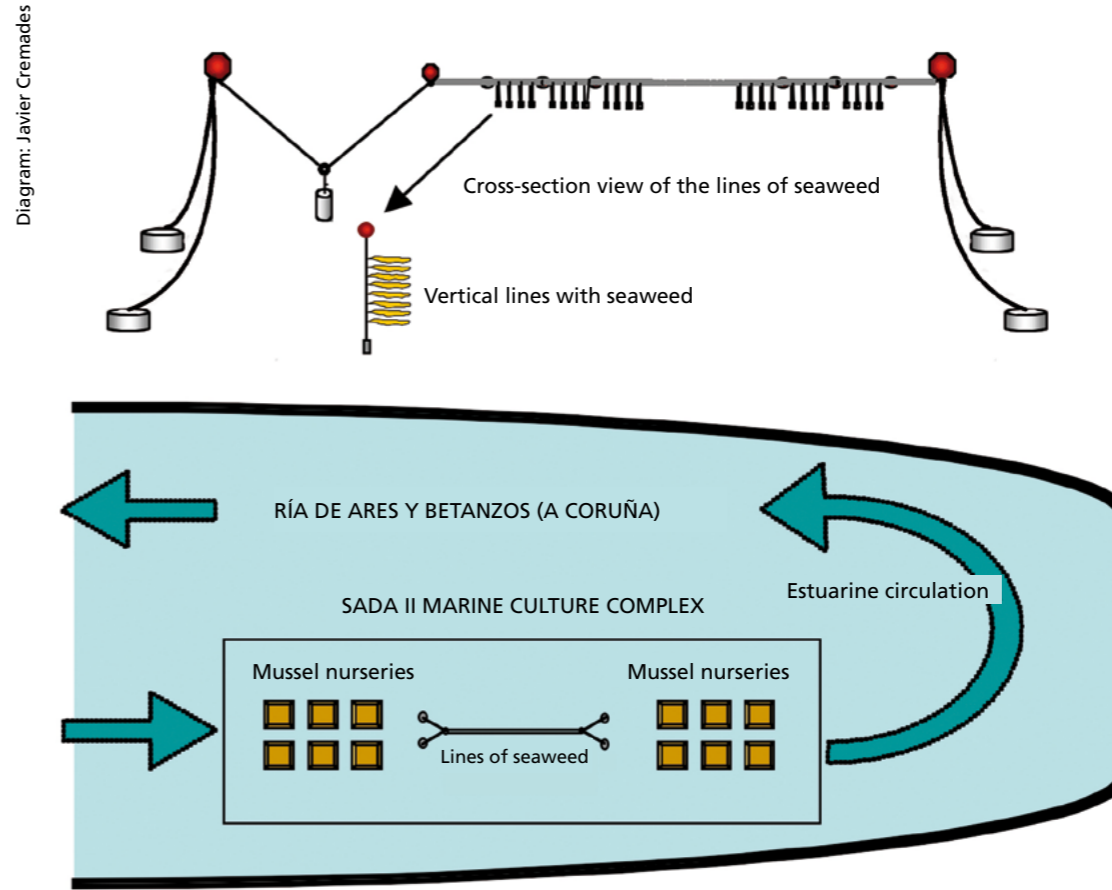

Left, diagrams showing the arrangements of the integrated culture in open sea. On the previous page and at the top, longline culture (Cremades *et al.*, 2007). At the foot of the page, a general view of the installation and details of the lines with the algae implanted at different stages of growth.

Photo: Authors' archives



Photo: Authors' archives



Fig. 1. Temperature variation in days of culture. On the right and foot, culture lines in the second sampling (10/03/2010).

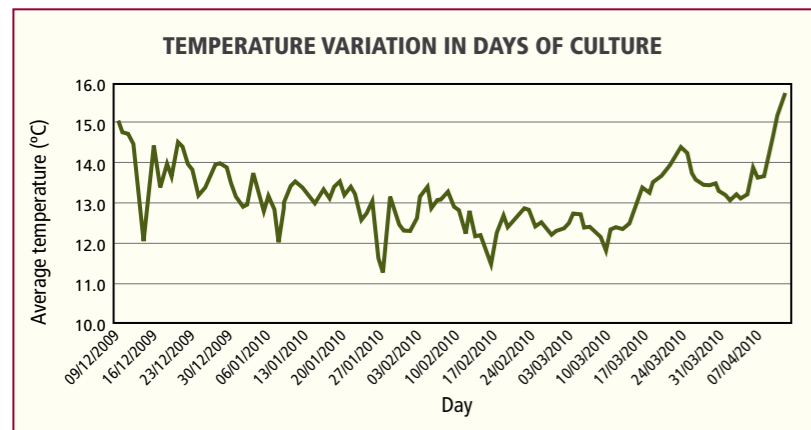

will allow us to evaluate in which proportion the algae have been feeding from the waste derived from the fish.

When evaluating the benefits of integrating the different cultures, we lack a “point of comparison” since regional government legislation forbids marine cultures outside the complexes demarcated for the same.

We note that, in any case, for the purposes of this evaluation, we have growth data and analytics on macroalgae from experiences in previous years carried out in other zones in Galicia and in other regions in the Iberian Peninsula, both in the open sea and indoors.

RESULTS AND DISCUSSION

As far as the environmental characteristics in this sea-borne installation are concerned, official oceanographic data are used due to the fact that the cultures are located in marine complexes that are controlled on a regular basis. Temperature data obtained during the experiment is shown in Fig. 1.

The development of *Saccharina latissima* during the experiment was optimum, with a maximum growth increase of 5% per day, which was recorded in early February. Average production per metre of line at the end of the experience was almost 6 kg., a figure lying within the production values in Galician waters obtained in other experiences (Peteiro, et al., 2006; Cremades et al., 2007).

In the data on weight, depth plays a determining role since, the deeper it is

located, the greater is the scarcity of light due to the shadowing caused by the individuals growing at a shallower depth as well as the gradual lessening of light penetration and the turbidity of the waters. The average values for the isotopic $\delta^{15}N$ ratio in *Saccharina latissima* were 6.8, a highly indicative value of the fact that the macroalgae farmed in this complex are assimilating, very significantly, forms of nitrogen excreted by organisms at a greater trophic level that surround them, probably the abundant ammonium that the filtering molluscs such as mussel excrete into the medium (Pérez Camacho, 1992).

REFERENCES

Cremades J., Freire O., Baamonde S., Salinas J.M. & Fuertes C. (2007) Nuevo método para el cultivo industrial de *Laminaria saccharina* (Laminariales, Phaeophyta) en las costas gallegas. *Actas XI Congreso Nacional de Acuicultura*, 1: 559-562.

Pérez R., Kaas R., Campello F., Arbault S. & Babaroux O. (1992) *La culture des algues marines dans le monde*. Service de la Documentation et des Publications (SDP). IFREMER. Plouzane.

Pérez Camacho A. (1992) Cultivo de mejillón en la batea. Cuadernos de Acuicultura. Ed. Consellería de Pesca, Marisqueo e Acuicultura. Xunta de Galicia, 48 pp.

Peteiro C., Salinas J.M., Freire O & Fuertes C. (2006) Cultivation of the autoctonous seaweed *Laminaria saccharina* on the Galician Coast NW Spain): Production and features of the sporophytes for an annual and biennial harvest. *Thalassas*, 22: 45-53.



Appearance of the culture lines in the final sampling (17/04/2010). In the figure on the right, note the difference in size due to the vertical stratification of the culture.

Photo: Authors' archives



Biofiltration of solids from the effluent of a turbot farming plant, in a closed circuit, with filtering molluscs (clam and oyster), suspensivore invertebrates (anemone) and food macroalgae (*Saccharina latissima* and *Ulva* spp.) in O Grove (Pontevedra)

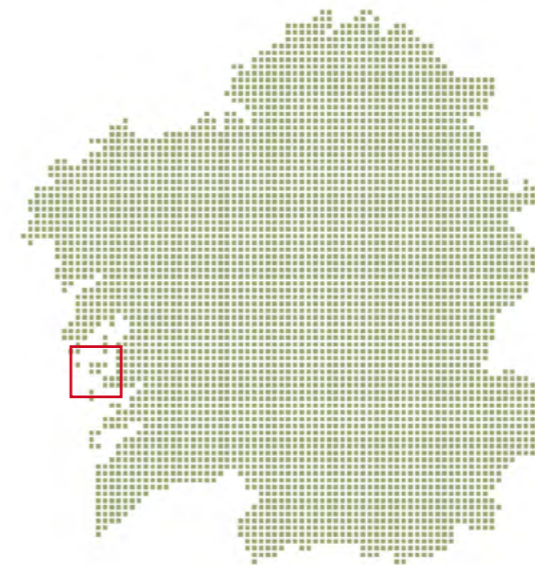

Place where the experience was conducted at Punta Moreiras – O Grove (Pontevedra). Images from Google Maps and ortophotos from the SigPac viewer of the Ministry of Agriculture, Food and Environment.



This experience, headed by IMTA, was conducted in the installations of a fishfarm on land, with the collaboration of PUNTA MOREIRAS, S.L.

(O Grove, Pontevedra). This company initially worked with turbot (*Scophthalmus maximus*) and now also works with sole (*Solea senegalensis*). The farm operates in

open circuit and the water is oxygenated by means of the Venturi effect. The plant has a production capacity of 300 MT per annum, with 2,500 m² farmed surface area, located inside and in darkness. One of the basic hypotheses was that the inclusion of cultures would generate, among others, the following benefits: improvement in the quality of the effluent water by having removed CO₂ and nutrients, both dissolved and in suspension. Another of the advantages was to ensure the viability of diversifying aquaculture production in the plant.

DESCRIPTION OF THE EXPERIENCE

Waters from the plant effluent were channelled into a biofilter of sedimentivore and filtering invertebrates, the function of which was to remove particles in suspension. Another of the biofilters was of macroalgae, which acted as assimilators of nutrients in dissolution. The effluent led out to the



Photo: Authors' archives

On this page, three moments in the launching of the circuit.

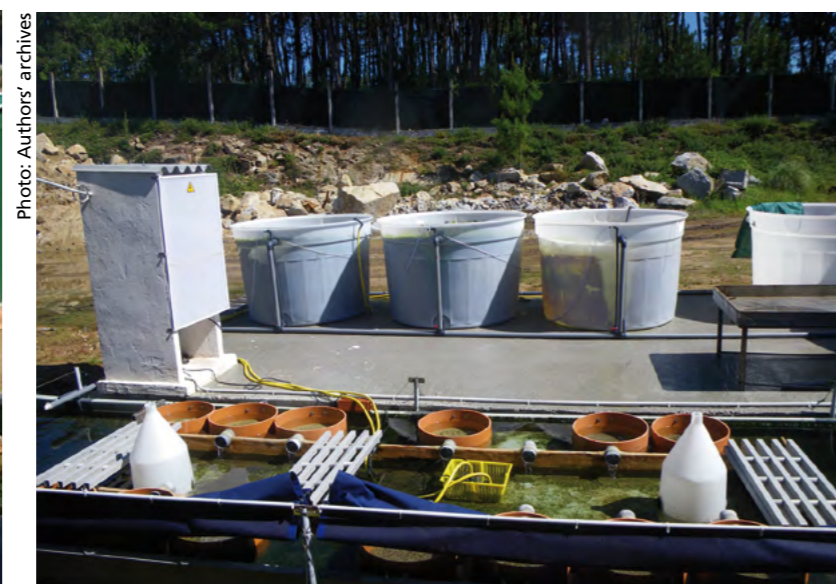

Photo: Authors' archives

exterior via a channel where a zone of sedimentivores with anemone, another zone of filterers with clam and oyster –with an initial size from one to two millimetres– were located. Finally, the circuit ran into 2,000 litre tanks with algae, which acted as assimilators. One of the main objectives was to evaluate the increase in productivity of these associated cultures, through using enriched waters, and also to check the absolute purifying capacity of the effluent.

The resource used to farm invertebrates was an open-air channel, 1.5 m in width by 30 cm in height and 25 cm in length, which received the effluent from the fish on-growing room and was divided into two zones. The first zone included a section for farming sedimentivore invertebrates (*Anemonia*

viridis) where, also in a natural manner, macroalgae (*Ulva* spp.) were grown. A second section incorporated a system for farming filtering invertebrates that basically involved a series of on-growing drums for grooved carpet shell (*Tapes decussate*), Japanese carpet shell (*Ruditapes philippinarum*), pullet carpet shell (*Venerupis pullastra*) and Pacific cupped oyster (*Crassostrea gigas*).

The second zone was a culture of assimilating algae, in a semi-open circuit similar to that already at the CIMA (Marine Research Centre – Regional Government of Galicia), but on a larger scale. This system entails one unit with four tanks, connected in parallel, with 2,000 litres, for farming algae in suspension. The species most farmed were *Saccharina latissima* (sugar kelp) during winter and

Diagram: Javier Cremades

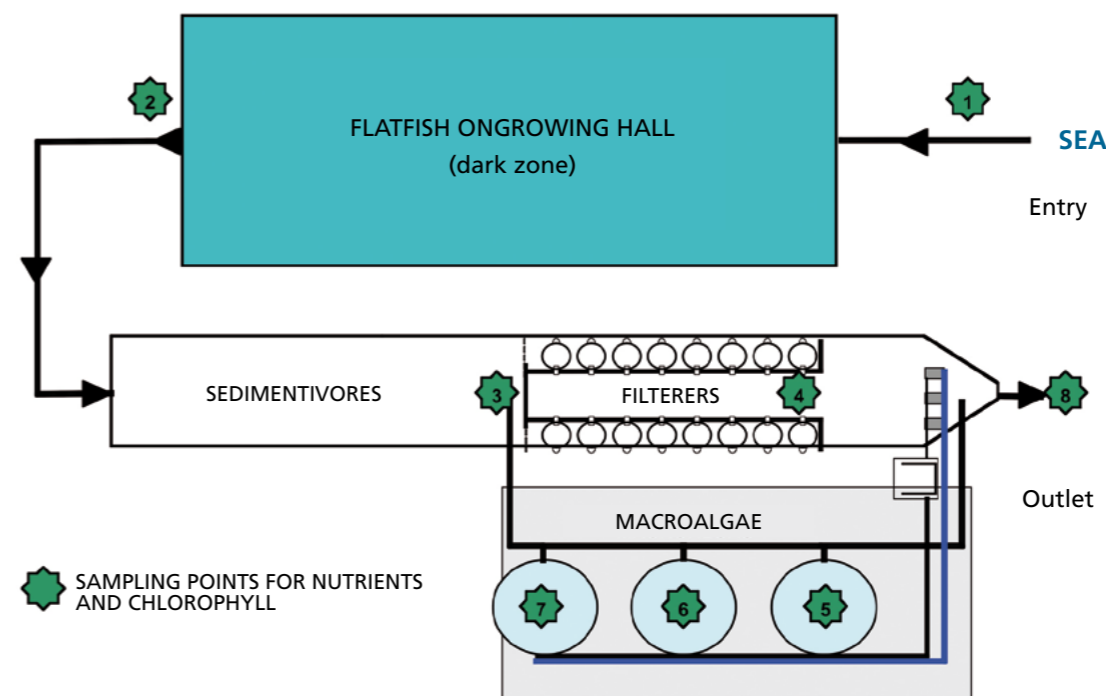

The diagram shows the sampling points for nutrients and chlorophyll at the water entrance (1), after passing through the fish (dark zone) (2), before and after passing through the bivalves (3 and 4), in the algae culture (5, 6 and 7) and at the installation outlet (8).



To the left, drum with Pacific cupped oyster seed.

productivity of algae and invertebrate cultures, in terms of what would be obtained in non-eutrophicated waters, the growth rates obtained were regularly compared with the results for indoor tank farming, in an open-circuit regime with contribution from oceanic water.

With a complementary experience, the growth of bivalve seed was recorded, in this case, for Pacific cupped oyster (*Crassostrea gigas*), in the effluent of the installation. This was compared with that of other seeds,

spring, and *Codium* spp. and *Ulva* spp, during summer and autumn.

This method makes it possible to isolate the systems of algae without affecting the other organisms during any possible treatment or cleaning processes and modify the rate and water renewal regime, in terms of the demands of the different species, densities and seasons of the year.

The algae and invertebrates used in this experience were collected from natural stocks and were also obtained in mollusc nurseries. Some clones of macroalgae came from the installations of the Algae Culture Plant of the I.E.O. in Santander and from the CIMA, in Vilanova de Arousa (Pontevedra).

RESULTS

Data are now available on the growth rate of the algae and of the suspensivore and/or filtering invertebrates, and also on the concentration of macronutrients before and after their passage through the culture zone. In order to estimate the improvement in

TRIAL WITH THREE TYPES OF FOOD IN *Crassostrea gigas*

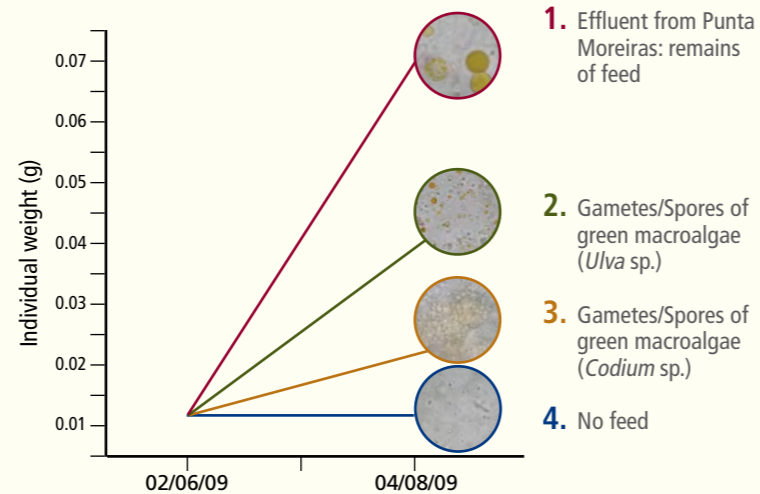

Final content of the hepatopancreas in the four cases:

1. Effluent: drops of fat are observed (from the feed) and a large amount of very small particles (remains of faeces); also some unicellular green seaweed and diatoms are observed.
2. Tank with *Ulva* sp.: large cells with granulous content and numerous smaller sized, golden coloured cells (gametes/spores) or almost colourless (digested) cells are observed. Some diatoms are noted.
3. Tank with *Codium* spp.: in less density, cells in similar size to the spores/gametes of *Ulva* are observed, but they are completely colourless.
4. Tank with no macroalgae: hardly no particulated matter observed.

associated with green algae *Codium* spp. and *Ulva* spp., as well as with another non-fed control culture, the three being developed at the CIMA installations.

The result was that the maximum growth occurred in the oysters maintained in the effluent. Some drops of fat were found in the hepatopancreas content, deriving from feed, as well as small particles (remains of faeces), and some unicellular green algae and diatoms. In growth in the seed of the CIMA tanks, with *Codium* and *Ulva*, only gametes and spores of algae were observed, which indicates that there are three forms of food in the circuit: one for phytoplankton (flagellates and diatoms), another deriving from the gametes and/or spores of green algae, and a last one coming from the feed.

Measurements of growth were also made of the growth of clams during 10 months. Total biomass increased from 2 to 29 kg. Out of the initial number of 300,000 individuals, a mortality of 18.5% was recorded in Japanese carpet shell and 12% in grooved carpet shell. But however, the increase in estimated economic value and the speed of growth in 30 days turned out to be very similar in both cases. It was concluded, therefore, that this system makes it possible to ongrow in an open circuit several commercial species of bivalves, maintained with the effluent from a turbot farm.

In another complementary experience, bivalve seed pre-ongrown at Punta Moreiras, was seeded in an intertidal park in Carril. The results of this work are explained in another section of this same publication.



Top, maintenance and monitoring work in the bivalves area. Right, monitoring growth of *Saccharina latissima* in a 2,000 litre tank.



As regards algae cultures, there are data on the different species and seasons of the year, the required regime and minimum flow required, so that the system can maintain the maximum sustainable biomass. This

This graph shows the data for two weeks for the variation in $\mu\text{mol/L}$ of nutrients, ammonia, nitrite, nitrate, phosphate and silicate, present in the seawater throughout the circuit. A considerable increase in ammonia is noted after passing through the fish (sampling point 2) due to eutrophication, whereas inside the seaweed culture it is reduced (sampling points 5, 6 and 7). The high value of ammonia recorded at the outlet (sampling point 8) is due to the fact that the greater part of the water flow does not pass through the seaweed circuit.

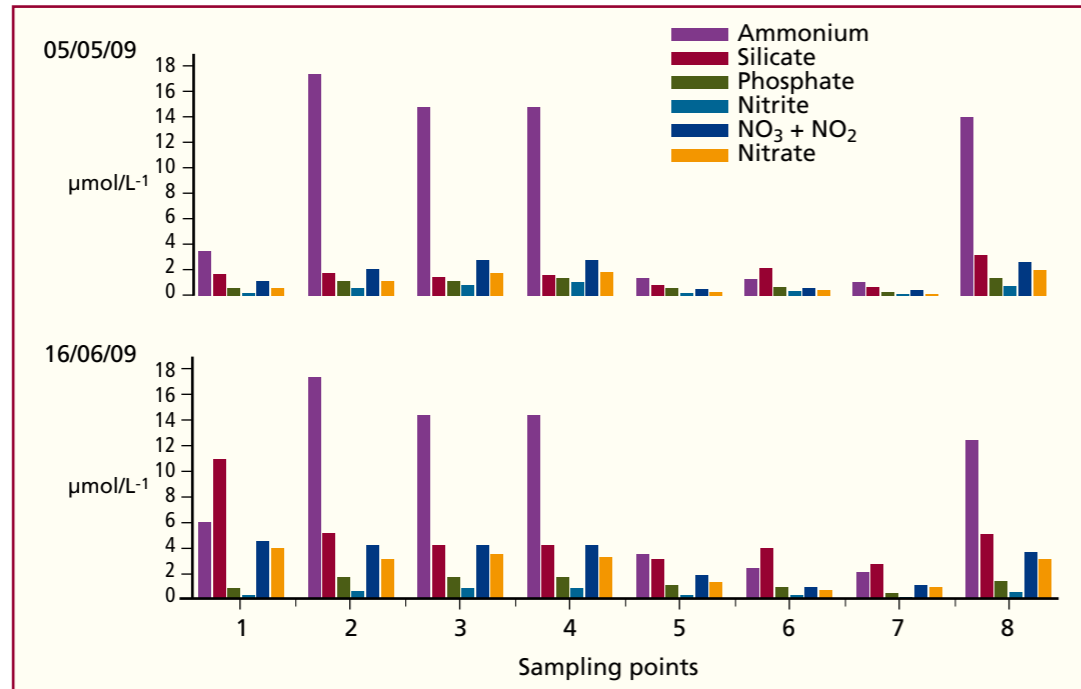

biomass had a cycle of partial harvests, which made it possible to calculate the productivity of the system by volume of effluent.

A comparison was made between the growth of two species: "sugar kelp" (*Saccharina latissima*), farmed in winter at a temperature below 17°C , and *Ulva* spp., as a summer species, as it coincides with its natural season of appearance on the beaches. It was proven that the yield, in terms of biomass production, is far higher in *Ulva* spp. The increase in biomass/month in 2,000 litre tanks, during the spring-summer period, was 37% for *Saccharina*, increasing from 8 to 12 kg., and 568% in *Ulva*, which increased from 4 to 27 kg. With the data on the variation in nutrients and chlorophyll A collected in the

circuit, the multi-trophic integration of the system was evaluated.

The improvement in the productivity of these cultures and the biofiltration capacity of the system were also estimated, analysing the characteristics of the water, before and after its passage through the different associated cultures.

As regards the evolution of plankton and nutrients in the water, important variations were noted in chlorophyll A concentrations, undoubtedly due to the production of phytoplanktonic blooms in the different zones in the system based on dissolved nutrients. As far as water quality is concerned, the most relevant fact was the drastic reduction in ammonia levels, following its passage through the macroalgae culture tanks.

Photo: Authors' archives



Anemonia viridis under the water in the zone for farming suspensivore invertebrates. Note the considerable abundance of particulated matter in suspension.

CONCLUSIONS

- The systems and practices applied in the experience made it possible to maintain various commercial species of bivalves in an open circuit regime, with the effluent from a turbot plant.
- Ammonia concentration increased in the water as it passed through the fish and mollusc tanks, and lessened as it passed through the algae.
- Chlorophyll A values lessened in the water, due to picoplankton ($0.7 \mu\text{m} < 2.7 \mu\text{m}$), on passing through the fish, in the dark zone, while increasing in the illuminated zone and in the zone of the macroalgae, to finally reduce when passing through the bivalves.
- There is a demonstrated interaction between

green algae and bivalve growth, due to the release of gametes and/or spores.

- Presumably, there are three types of food for bivalves: microalgae, spores and gametes from macroalgae and microparticulated feed.
- Mollusc biomass grew from 2 to 29 kg. in a period of 10 months.
- In the case of algae, the increased biomass/month in 2,000 litre tanks and in spring-summer was 37% for *Saccharina latissima*, which grew from 8 to 12 kg. In the case of *Ulva* spp., it was 568% since on-growing increased from 4 to 27 kg.
- Reproduction by bipartition of anemone (*Anemonia viridis*) was demonstrated.

Ongrowing of grooved carpet shell and carpet shell clams from multi-trophic seedbed at the farming park in Carril (Pontevedra)



The experience described here mainly set out to look into how growth evolves, in an intertidal park, with seed from two commercial bivalve species: grooved carpet shell and carpet shell clams, from a nursery, that were pre-ongrown by a multi-trophic aquaculture system. As explained earlier, this system used effluent from a turbot ongrowing farm with a closed water circuit.

The results of this study complementary to the experience in Punta Moreiras, demonstrated the feasibility of pre-ongrowing seed from these two species, applying a multi-trophic culture and their aptitude for subsequent ongrowing in a farming park. As far as the authors are concerned, this is proof that multi-trophic pre-ongrowing, which differs from that conducted in a conventional seedbed, is applicable to the processes and stages of bivalve cultures.

OBJECTIVE

The objective of the experience described here was to evaluate the advantages or possible disadvantages of ongrowing in an intertidal farming park of bivalve mollusc seed pre-ongrown in integrated multi-trophic culture systems, as opposed to that from traditional seedbeds.

MATERIAL AND METHODS

1. Pre-ongrowing in a multi-trophic system. (15/10/08-05/08/09)

The multi-trophic system was developed with biofiltration of effluent from a turbot farming plant in open circuit using filtering molluscs (clam), suspensivore invertebrates (anemone) and food macroalgae.

The following advantages were obtained with this integration:

- Improved quality of the water from the effluent due to removal of CO₂ and nutrients, both dissolved and in suspension.
- Check the feasibility of increasing and diversifying aquaculture production in the plant, in this case, with ongrowing of bivalve mollusc seed, and the production of other invertebrates and food macroalgae.

Pre-ongrowing commenced in the seedbed with:

	Grooved carpet shell	Grooved shell
Size	2.58 mm	2.87 mm
Individual size	0.012 g	0.010 g
Total weight	500 g	1700 g
Total individuals	108,500	196,600

2. Seeding (05/08/09)

Once the seed has reached the appropriate size, it is transferred for seeding in a 600 m² plot of land in the Carril park. When transferred, the data on size and weight for both species were:

	Grooved carpet shell	Grooved shell
Size	7.96 mm	7.03 mm
Individual weight	0.11 g	0.088 g
Total weight	265 g	340 g
Total individuals	2,359	3,864

3. First year in park. (05/08/09-10/08/10)

Seeding was checked after one year, with a random sampling of 30 individuals. Total weight of the sample was measured with a dynamometer and the individual length of each of the species was taken:

The biologist, Salvador Guerrero, (left), at the Carril park where grooved carpet shell and carpet shell seed were ongrown, from a multi-trophic culture experience at a turbot fish farm in open circuit.

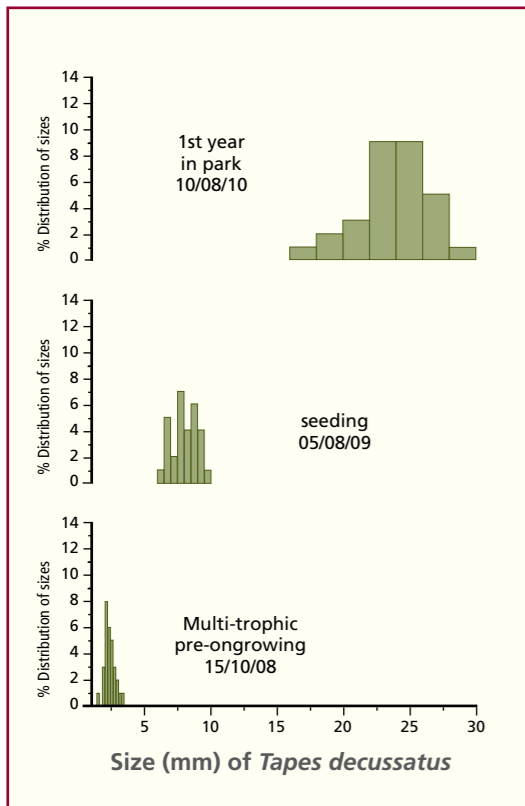

Photo: Authors' archives



Grooved carpet shell and carpet shell, from a nursery and pre-ongrown in a multi-trophic aquaculture system, ready for seeding in the farming park. Top, location of the Carril farming parks. Images from Google Maps and ortophotos from the SigPac viewer at the Ministry of Agriculture, Food and Environment.

Photo: Authors' archives



Figs. 1 and 2. Distribution of sizes (in mm) of grooved carpet shell clam (*Tapes decussatus*) and carpet shell clam (*Ruditapes philippinarum*) from pre-ongrowing in a multi-trophic seedbed to the first year in a farm park.

	Grooved carpet shell	Grooved shell
Size	23.72 mm	27.91 mm
Individual weight	3 g	5.83 g

The park was cleaned at regular intervals, eliminating algae, predators, remains of shells and dead bivalves.

RESULTS

Figures 1, 2 and 3 show the distribution of sizes in the samplings: at the start of pre-ongrowing, during seeding and after one year in the farming park.

Data is also given on the growth in size and individual weight, during the study period.

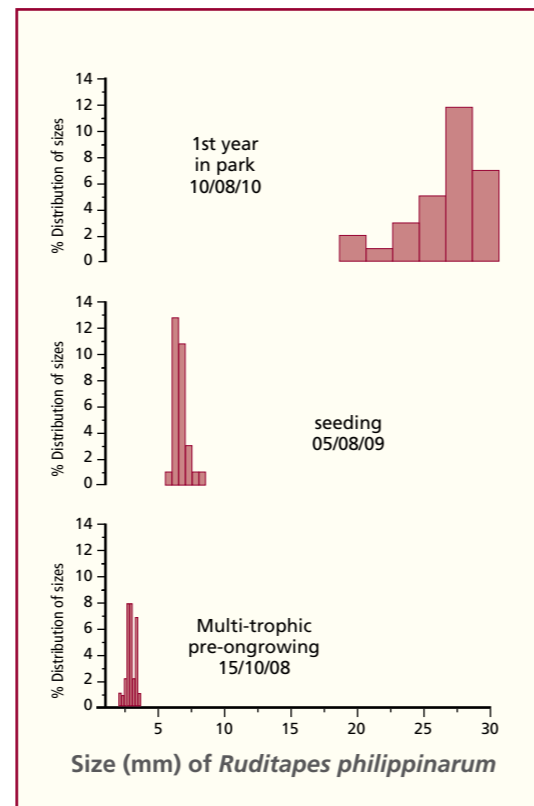

CONCLUSIONS

- While during the multi-trophic pre-ongrowing process there are no significant differences in growth between grooved carpet shell and carpet shell (experience in Punta Moreiras), at the end of the first year in the park a difference was noted between both species, with the grooved shell growing to a larger size.

- In the future, we may consider optimizing a bivalve seed culture system, both for grooved carpet shell and for carpet shell, with a multi-trophic type pre-ongrowing process in installations on land. The behaviour of the individuals obtained in this manner, from when seeded in the intertidal park and during ongrowing, does not differ from a clam seed culture from a traditional seedbed (Santamaría et al., 2009).



Photo: Authors' archives

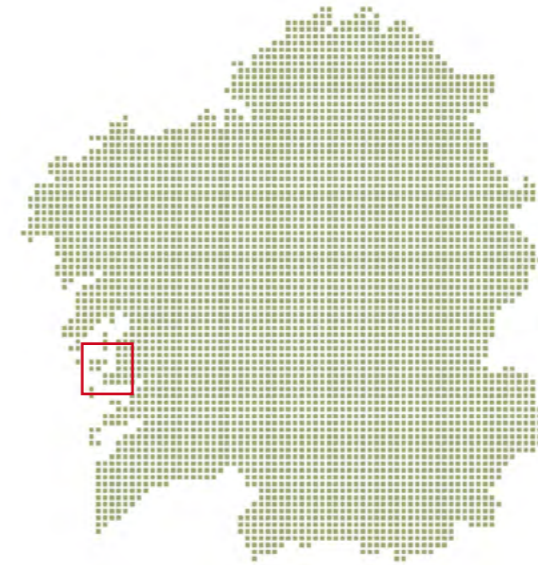

Fig. 3. Growth in size and individual weight during the study period of the two species.

Photo: Authors' archives



Incorporation of cultures of *Saccharina latissima* and of suspensivore and filtering invertebrates in a turbot and common sole production plant, with water recirculation, in Cambados (Pontevedra)



Aquacria Arousa has its installations in Bico da Ran, Cambados (Pontevedra). Images from Google Maps and orthophotos from the SigPac viewer of the Ministry of Agriculture, Food and Environment.

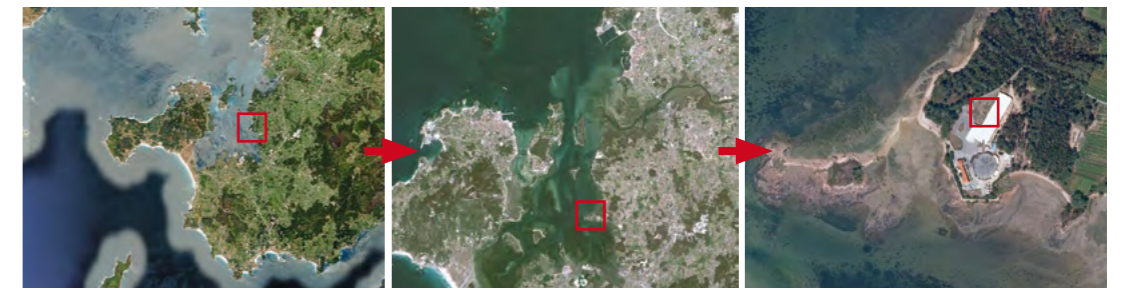

The main industrial task for the Aquacria Arousa S.L. fish farm is to ongrow flatfish. Producing turbot (*Scophthalmus maximus*), this farm currently also rears common sole (*Solea senegalensis*). This is one of the first marine farms to

adopt the closed circuit water system. With a production capacity of 500 tonnes per annum, it covers a working surface area for farm of 10,500 m². Plans are to expand in order to reach 1,500 tones per annum of flatfish.

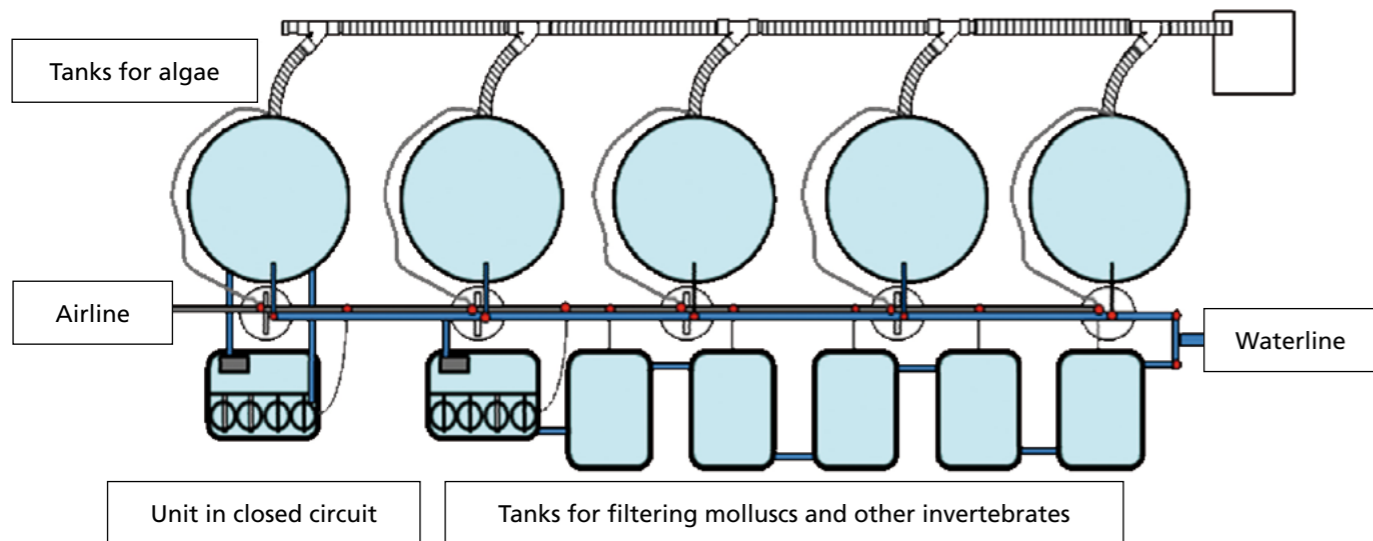

Overall design of the facility used for IMTA experiences at the Aquacría Arousa fish farming plant (Cambados, Pontevedra).

Effluent from the fish farm passes through a complex purifying system of mechanical and biological filters and, finally, it undergoes bacteriological treatment to ensure that bacterial flora associated with the culture is controlled. The system automatically regulates various parameters, such as pH and water temperature. A given volume of water is renewed on a daily basis, ranging from 5 to 10%. Furthermore, all the physical-chemical parameters affecting water quality are regularly analysed.

The company has contributed to the IMTA experience, with no economic consideration, a surface area of 120 m², with power outlets and filtered water outlet of the same quality as that present in the installation, to be used in a seaweed circuit. It has also made available another flow of non-filtered water from effluent for experiences with filtering and sedimentivore organisms.

Some of the main objectives of this work involved obtaining data in order to evaluate the increases in productivity of these cultures associated with fish production, with the use of nutrient enriched waters. The work also made it possible to control the capacity to improve the quality of water from effluent by removing the CO₂ and both solid and dissolved nutrients. Attention should be drawn to the fact that the species of food seaweed, the sedimentivore invertebrates – anemones and polychaete worms – selected, besides their high degree of operativeness in other systems, have a high economic potential.

PREVIOUS EXPERIENCES

The first case of this experience involved studying at the CIMA installations, using experimental circuits, culture in suspension of food seaweeds, particularly *Saccharina latissima* (“sugar kelp”) and *Ulva* spp. (sea lettuce). Work was also conducted in the



Tanks where the experiences were conducted at the Centre for Marine Research of the Regional Government of Galicia (CIMA-Corón, Pontevedra) and detail of the system used.

laboratory on developing culture methods and techniques for filtering molluscs and suspensivore invertebrates, especially the cnidarian *Anemonia viridis* (anemone) and polychaete worms *Arenicola marina* (lugworm), *Alitta virens* (king ragworm), and *Nereis aibuhitensis* (Korean sand worm), a selection made with the criterion that it should include integrable species, following appropriate scaling, in the fish farm installations.

FOOD MACROALGAE CULTURES

At the initial stage, juvenile plants of *Saccharina latissima* were used, measuring

around 10-20 cm, obtained from the germoplasm bank of “El Bocal” algae culture plant at the I.E.O. Santander. At this point, plants of *Ulva rotundata* were used, also cultured at these installations. Both species have a high growth rate and good assimilation of dissolved nitrogen, and are increasingly used in human and animal food industries.

Polyethylene tanks with a capacity for 2,000 litres were used in these experiences where the movement of seaweed farmed in suspension was by injecting air along the



Macroalgae farming tanks at the Aquacría installations. On the left, with *Saccharina latissima*. On the right, with *Ulva rotundata*.



lower side of the tank. As stated above, the water used is from the effluent of fish and is mechanically filtered in order to remove particles over 70 µm. Experiences commenced in February 2011, and continue to the present.

Since culture in suspension of *Saccharina latissima* in fish farm effluents lacks any precedent, the work conducted sets out to determine, in a preliminary manner, the influence of the main factors of this type of culture.

The first experiment gave data on the ability of algae to consume nutrients in the medium, and so it was possible to establish a minimum of necessary renewal system, so that their growth generates an optimal production value. To achieve this, the decrease of the nitrate concentration without renewal of water, based on a

Tanks in which the experiences were conducted at the Aquacría installations.

density of 2 kilos per m³, was analyzed, noting that after 12 days of farming, over one third of the Initial nitrates still remained in the water tank that were approximately 7 mg/l of N as NO₃.

This reveals that the renewal rate with such enriched water can be very low and that, in this case, it would be necessary to measure and control pH values automatically at times of maximum photosynthetic activity so that they do not exceed lethal values due to the high growth rate of the species.

The second experiment set out to determine the optimal culture density, which is one that, with unlimited nutrients, gives the highest net return. To achieve this, low initial densities were applied as a basis in a high turnover regime (half a tank a day) in order to estimate weekly biomass increase density and to identify at which density the system shifts into a stationary phase. So far, we have achieved densities of 4 kg/m³, a figure that is likely to be higher if we conduct the experience in a seasonal period more suited to farming the species.

It should, unfortunately, be admitted that this experience could not be concluded with the expected success, because it started very late and the environmental conditions, especially the temperature in the last two weeks of the experience (late April), were limiting for developing *Saccharina latissima*.

From these experiments it is concluded, therefore, that the cultivation of *Saccharina latissima* in outdoor tanks, at least in the

tested location, is feasible from October to April, and that the maximum productivity is obtained at least at densities of 4 kg/m³. From May onwards, the crop must be replaced in IMTA system, by a more thermophilic and photophilic species and, in fact, this is what we are now doing, farming *Ulva rotundata* with very good results.

INVERTEBRATE CULTURES. ANEMONES

Anemonia viridis (snakelock anemone) is a cnidarian of the class anthozoa, which has been recently studied on the coasts of Galicia to determine its abundance, reproduction and sustainability of exploitation of natural populations in order to regulate their commercial extraction, originated by its increasing economic interest and gastronomic and nutritional values.

In this case, we compared the growth of the species using the two types of water available in the fish farm, i.e., filtered and rich in solid particles. At 45 days of culture, the population kept in unfiltered water experienced a 50% increase in total biomass. In addition, the number of individuals by asexual reproduction (bipartition) of larger fish also increased. But however, the



population of anemones kept in filtered water did not increase in number and dropped 33% in weight.

These results clearly demonstrate the protein value of fish faeces, feed residues and flocculated bacteria present in the effluent from the fish farm, as well as the tremendous future that this species may have in IMTA systems, especially in view of their asexual reproductive capacity and economic value.

Below left, specimen of *Anemonia viridis* at the time of the bipartition, next to this, tank where anemones were kept and detail of some specimens.

POLYCHAETES

There is a large market for marine polychaetes used as bait for fishing and as a food supplement in farming crustaceans and fish. Today in Galicia, several exotic species from Asia, or autochthonous species collected in the wild, are marketed. Techniques for growing these species in Spain are still at a very pioneering stage, and are clearly inadequate for meeting demand.

Some survival experiences were also conducted outside the aquatic environment of the species studied, species that are of interest for possible marketing of such species. Previous work projects at the CIMA laboratories, using *Nereis aibuhitensis* (Korean ragworm), set out to compare the nutritional value of the mud in the water effluent from a fish farm with other food sources such as fish feed, with and without substrate, and beach mud.

The results of this experiment show that the best yields are obtained using mud as food only when it measures less than 1 mm, from the fish farm effluent and when it is mainly composed of remains of feed, feces and

bacterial flocculates. After one month with this type of feed, a total average increase of 12%, and a 100% survival were obtained. However, with a mixture of sand and mud, growth has been zero, with a mortality in the same period of 12.5%.

Another analogous experiment was conducted with *Arenicola marina* (lugworm) since, a priori, it is a good candidate because, unlike nereididae, which are carnivores, it is a sedimentivores species capable of assimilating organic matter available in the substrata. Extremely good results were obtained with this species, using a mixture of substrata composed of a fourth part of mud from a fish farm and three quarters of sand. Under these conditions, at 39 days, an average growth of 106% was obtained. Although this species shows a higher growth than that of carnivorous polychaetes in the nereididae family, has the disadvantage of a high mortality rate. So, although it has a considerable potential for being used in purifying mud from fish farms, further research and experiences are needed more in order to improve their survival rate.

From left to right, specimens of *Nereis aibuhitensis* (Korean ragworm), *Arenicola marina* (lugworm) and *Alitta virens*.



Photo: Authors' archives

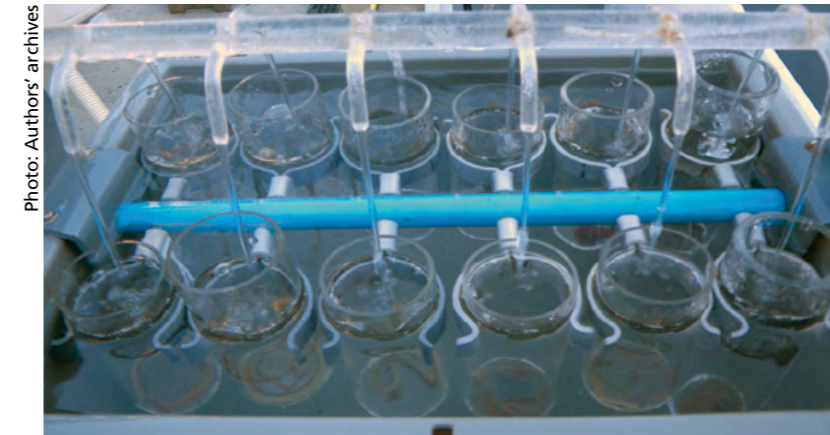

Photo: Authors' archives

These initial experiments indicate that the three species can be fed with solid mud from fish farms. As is already known, the species *Alitta virens* and *Nereis aibuhitensis* are carnivorous, indicating that the mud from fish farms contains a protein value high enough to feed any type of polychaete.

In view of the good results obtained with mud in the previous experience, we conducted a second experiment, this time at the Aquacría plant, to ensure that residual particulate matter from the effluent is sufficient for the growth of the two nereididae polychaete species that showed better survival rates: the autochthonous *Alitta virens* and the allochthonous *Nereis aibuhitensis*. It was also possible to compare the growth and mortality rates in this new environment. In the system tested, air-lift drums were used inside containers fed with water from the effluent water, containing a coarse washed sand substrate and a base of fine sand, to enable polychaetes to bury themselves. The system is designed to act as

Experimental system used in previous experiences with polychaetes at CIMA.

Experimental system for polychaetes used at Aquacría, incorporating with drums with sand tank, aeration and water flow.



Photo: Authors' archives

a filter and to allow the particulate matter to gradually accumulate on the surface.

Preliminary data from this experiment indicate that the native species *Alitta virens* shows greater adaptation to the culture than the allochthonous *Nereis aibuhitensis*, which is noted by a higher growth and lower mortality rate.

CONCLUSIONS

In view of the results obtained in cultures of suspended algae and with various suspensivore invertebrates, and based on our previous experience with filtering molluscs in this type of system (see the Punta Moreiras experience), it seems likely that, in the near future, it will be feasible to optimize an IMTA system on land, combining fish/anemone/polychaetes/molluscs/macroalgae, which will generate a diversification of production and a substantial improvement in the management of mud and in the quality of effluent discharged into the sea.



TESTIMONIALS

Scientists and experts provide criteria, data and results of experiences in the field of sustainable integrated aquaculture

Research works on IMTA developed in several countries focus on analyzing the scope and efficiency of an alternative to make aquaculture more sustainable and productive. On these and other aspects a group of experts, including scientists, entrepreneurs and managers express their views.

In some cases, the collaborations provide proven knowledge about the processes of integrating cultures and, in others, they describe resources to assess and take advantage of aquaculture waste. There are also evaluative analyses on IMTA and authors describing the objective difficulties to be overcome to in order to make further progress. In any case, it is an opinion and input of data, to encourage reflection in this regard within the scientific community, in government fisheries and in the aquaculture industry.

The team of researchers who conducted the IMTA experiences in Galicia, in the framework of Jacumar, agrees in pointing it, through their collaborations, the need for administrations to continue with their commitment to the continuity of such works and also to facilitate communication and information exchange in this area. Another common criterion is that IMTA is feasible from the environmental, production and cost points of view for the system of marine aquaculture in Galicia.

Galicia's commitment to aquaculture. The Galician Aquaculture Strategy



Juan Carlos Maneiro Cadillo (1958), a biologist from the University of Santiago de Compostela was a professor at this university until 1988. Between 1991 and 2005, he worked at the Technological Institute for the control of the Marine Environment (Intecmar), where he was director between 1997 and 2005. Between 2005 and 2009 he worked for the Valencian Association of Aquaculture Enterprises (AVEMPI), heading a mussel processing industry and, finally, in mid-2008 he was Deputy Director of the Spanish Association of Fishing Towns (AECIPE). From 2009 to January 2012, he was Director General of Competitiveness and Technological Innovation at the Galician Regional Maritime Department of the Regional Government of Galicia, and is currently Secretary General of the Rural and Maritime Environment, with the competences assigned to the Department in aquaculture planning and management.

The Galician Aquaculture Strategy (ESGA) is established as an instrument for articulating and organizing govern the planning and management of aquaculture activity in Galicia, in terms of the horizon of 2030. Its main objective is to relaunch aquaculture so that it generates employment and wealth in a balanced manner, with environmental respect and integration. It is grounded on a unanimous commitment to the European decision-making and consultative frameworks for aquaculture and, in the Galician regional framework, it will respond to the need, established by the reform of the Common Fisheries Policy, to have a multi-annual strategic plan for aquaculture by 2014.

Galicia has a privileged marine environment where the Atlantic Ocean and the Cantabrian Sea have been generous in providing well-being and wealth. For this reason, the Galicians have been involved in an intense struggle over the centuries, forged in the know-how, in sacrifice and the effort of sailors, fishermen and shellfish collectors.

Over the last few decades, this work has begun to take in production processes associated with marine farming, making the economic and social ties of the whole Galician maritime and fishing scenario stronger, within the general framework of our productive activities linked to the sea.

However, while a slowdown in recent years of European aquaculture and Spanish is still evident, which also affects Galician aquaculture, new trends and commitments within the Community framework (the

new Common Fisheries Policy, CFP), point to prioritizing the development of marine farming for which, from the Xunta de Galicia, working on promoting a relaunch to bring back the productive and innovative dynamism that characterized it in the past.

In this regard, Galicia sets out to become an example by develop a broad-based commitment to aquaculture within its territory, working to recover the momentum that the Galician aquaculture sector has always had, which led us to rank at the leading edge of this activity, at national and international levels, in areas such as miticulture, farming flatfish or trout.

Galicia, following the proposals formulated in the European Union area by different political and administrative fields such as the European Commission itself, the European Parliament or the European Economic and Social Committee, has developed a strategic

framework for planning and relaunching aquaculture, with a time horizon up to 2030, linking the different measures not later than the end of 2014.

The fulcrum point on which this initiative rests is the Galician Aquaculture Strategy (ESGA), which primarily aims to achieve the balance and sustainability of aquaculture in terms of environmental, social and economic considerations, from a comprehensive and inclusive approach, able to make progress in all fields related to Galician aquaculture.

In this regard, this strategy will be integrated in line with the territorial planning established in Galicia by the Regional Planning Guidelines (DOT) and, in coastal areas in particular it will be developed in accordance with the provisions of the Coastal Management Plan (POL). Likewise, it is the tool that will specify the commitment and support for aquaculture established by the Regional Council of the Galician Government, by adopting the "Declaration of aquaculture as a matter of prime public interest" for Galicia.

From a holistic and integrated viewpoint of aquaculture, the strategy establishes new steps to advance qualitatively and quantitatively in terms of regulatory and administrative frameworks set in previous

management plans for aquaculture, such as the Food Technology Parks Plan for 2005 or the Galician Aquaculture Plan 2008.

Actions to achieve a comprehensive scope, ranging from the modification and specific strengthening of the regulatory framework, with measures such as the development and adoption of the Galician Aquaculture Law, the Decree on the Ordinance of farming parks park or the reform of the Fishermen's Guilds of Galicia Law, while improving management structure with competencies in aquaculture through actions such as the internal reorganization of the former Regional Maritime Department of Galicia or the creation of a Centralized Processing Authority, taking advantage of the synergies of collaboration with other consultation bodies already in place, such as the Regional Fisheries Department of Galicia or the Galician Scientific Committee on Fisheries. At the same time, others will be created as the Technical Aquaculture Committee or the Observatory for Aquaculture Marketing.

The strategy also develops the overall planning of the aquaculture sector in all physical areas of Galicia (maritime, maritime-land, land-coast and the interior), promoting the drafting of the Master Plan for Coastal Aquaculture, the Fishfarming Management Plan and the Ordinance Plan for farming in the Maritime-Land zone.

The CIMA headquarters in Pedras de Corón, Vilanova de Arousa (Pontevedra).



In a commitment to quality, the strategy includes the development of various codes of good practice in aquaculture and specifically encourages research and innovation, establishing strategic lines of action and the establishment of collaborative frameworks that allow for the use of technical and human resources, equipped with the extremely important infrastructure that Galicia has in this field. And parallel paths will be taken in the training framework.

On the other hand, in view of the fundamental importance that marketing has on the feasibility of the aquaculture, the strategy directly affects the adoption of measures and actions to ensure that the products are sold adequately, in order to increase their value and to coordinate supply and demand, with special emphasis on coordination with the processes of marketing and product processing coming from catches.

The strategy also provides the necessary mechanisms to identify ways of promoting aquaculture, either by improving society's view of the activity itself or the commercial assessment of their products.

In the context of ESGA, Integrated Multi-trophic Aquaculture, IMTA, is expected to play a key role in the relaunching of Galician aquaculture, not just in the physical marine

environment or coastal areas, but also in the interior, combining coastal aquaculture with agricultural activities and/or livestock, based on its ability to provide a highly sustainable management model.

In this sense, IMTA must necessarily contribute to solving some of the weaknesses and threats in Galician aquaculture, as identified by ESGA and, basically, should contribute to the diversification of some of the current monocultures characteristic of Galician aquaculture (floating mussel beds), maintaining the distributive social structure of some aquaculture models (mussels and in a sense, shellfish collecting), and its compatibility with the models of industrial exploitation, while minimizing environmental impacts, competition for space and contributing to improving the social perception of this activity, among others.

In Galicia, IMTA still lacks the necessary regulatory framework necessary for being implemented with full guarantees. Within the context of ESGA and, more specifically, the Galician Aquaculture Act, particular attention is drawn to the development of all administrative regulations providing legal security, economic feasibility and environmental sustainability of IMTA.

juan.carlos.maneiro.cadillo@xunta.es

Commitment to IMTA

Photo: Jorge García



Salvador Guerrero Valero, Doctor in Biology, began work on marine farming in Galicia in the early 70's. Initially focusing on farming oyster and grooved carpet shell and pullet carpet shell clams. In 1975, he joined the team of scientists in the Shellfish Plan, a pioneering research organization in Galicia. One of its work lines was to set up mollusc nurseries. The body of work on flat oyster is the central issue of his doctoral thesis. He has worked with triploid clam in Conwy, United Kingdom, with oyster at Rutgers University in New Jersey, and mussels at Taylor's Hatchery, also in the U.S.A. Commissioned by the FAO, he selected the site, designed and launched the first mangrove oyster farm in Cuba. He is currently working for the Marine Research Centre (CIMA), under the Regional Government of Galicia.

Some of the data produced to date from the experiences of integrated multi-trophic aquaculture (IMTA) in Galicia indicate that particulates waste from feed and fish feces improve growth rates of bivalve filterers. There are also positive results with growth, filtering capacity and assimilation of nitrogen from the seaweed "sugar kombu" in long-line cultures in the Rias of Muros, Ares and Betanzos. On the other hand, tests carried out with polychaetes and anemones, fed with mud from the effluent from a flatfish farm have demonstrated a good survival rate and help to making parallel cultures, using the effluent, which would also reduce eutrophication.

Everything appears to point to the fact that, in the coming years, IMTA practices and systems will be adopted by the aquaculture industry worldwide. In the case of Galicia, where thousands of jobs associated with farming molluscs and fish, certain peculiarities should be taken into account, such as the existence of large areas of the estuaries taken up by monocultures, which is a circumstance to be considered.

Although the future for integrated marine farming described here is largely optimistic, there is no denying that there are great difficulties to overcome and complex problems to be solved. IMTA, in general, optimizes the performance of installations on land and in the marine environment

of farms while promoting diversification of cultures. The presence of efficient biofilterers, algae and molluscs, in different combinations, guarantees a significant reduction of the environmental impacts of these activities. Experimental knowledge transferred to the aquaculture industry has a good level of development, in countries where research into IMTA has been made with method and perseverance.

In my opinion, there is a need to extend the work that we have carried out in Galicia in terms of IMTA. Most of the data points

It is expected to be necessary to revise the regulations for the use of the marine environment in terms of promoting the diversification of production and reducing environmental impact

to the fact that integrated multi-trophic aquaculture in the fish farming system in place in Galicia is industrially viable. With new experiences, further consistency will be given to the knowledge acquired.

Moreover, in order to initiate an IMTA process in marine farming on the Iberian peninsular coastline, collaboration between research organizations under the Galician Regional Government, the University of A Coruña, some companies in the sector and

the Spanish Institute of Oceanography has been very positive, all of which has enabled work to progress favourably.

Among the suggestions that can be made as regards the next steps that need be taken, is the need for continuity in the experimental work and to make IMTA known as a solid alternative for sustainable aquaculture and, therefore, for it to be understood and accepted by society at large.

To further this process, the three main partners are the fisheries administration, researchers and industry, which includes both guilds as entrepreneurs. It is also expected to be necessary to revise the regulations for the use of the marine environment in the sense of promoting diversification of production and reducing environmental impact.

Finally, to enable the aquaculture industry to contribute to economic rationality and good management of the marine environment posed by the IMTA, one of the key conditions is that the regional, central and community administrations should continue with their commitment to analyzing feasibility and evaluating the objective advantages of adopting the increasingly widespread protocols, practices and systems practices.

salvadorg@cimacoron.org

Galicia, a good place for IMTA

Photo: Jorge García



Javier Cremades Ugarte (Vitoria, 1959) is a Doctor in Pharmacy and professor at the University of A Coruña in the field of Botany, as well as promoter and coordinator for the university's Inter-University Masters and PhD in Galician Aquaculture. Since 1992, he heads the team researching into marine benthonic algae. In collaboration with the company Porto-Muiños, he has developed research projects designed to bring the main species of edible seaweed off the coast of Galicia out of their anonymity. He also works in the development of marine farming for some of these species. He has steered four doctoral theses and has authored several books and scientific papers and more than one hundred articles published in scientific journals, both national and international, mostly focusing on various aspects of the marine algae of Galicia.

As with most scientific and technical discoveries – as occurs with the evolution of human thought - we tend to attribute them to a single person, the discoverer, but in actual fact, such a finding is nothing but the result of a sufficient degree of maturity of the society at large and has many fathers who have contributed, in one way or another, to its making. If it were the work of one man, it would not be understood and would fall into oblivion, as so often has happened with the ideas or discoveries of pioneers of the day.

In my opinion, Integrated Multi-trophic Aquaculture (IMTA) is not a utopia since it appears at a historical moment when initiatives and experiences inspired by it arise everywhere and independently. It is a new call for a diverse, productive, sustainable and environment friendly aquaculture. It is an activity which, as is often the case, the Orientals have practiced since time immemorial, albeit empirically and not in the full sense of the term, and with which us Westerners have recently become obsessed, bent on introducing technology, purifying and making an in-depth analysis from the scientific-technical and business angle.

Almost everything has been invented and anyone would think that we could do the same in aquaculture as we do in agriculture, that we can approach the concept of pasturing, of a sustainable exploitation of the

ecosystem able to create employment and wealth, biological and cultural diversity and even beautiful scenery. It is almost a truism. But why have we not done this before now? I think the reason is twofold: firstly, because we are hardly aware of the “waste” deriving from aquaculture, which is diluted into the vast sea or is hidden under its surface and, secondly, because we lack interest and expertise in farming and harvesting marine macroalgae, the prime producers needed for existence in a real multi-trophic system, the main organisms capable of using, in their

Integrated Multi-trophic Aquaculture (IMTA) is not a utopia since it appears at a historical moment when initiatives and experiences inspired by it arise everywhere and independently

development, this so-called “waste” and of regenerating the environment. But this is changing: we are increasingly concerned about waste management and, in any supermarket, we can find Galician seaweed for our consumption, if of course, we know how to prepare them.

Multi-trophic aquaculture must, therefore, be linked to the development of seaweed farming and its subsequent economic upgrading, at least in sectors such as human

and animal food, in the same manner that cows eat the grass of the meadows, the pigs acorns of the pasture and we the vegetables from our gardens. Farming marcoalgae does not waste land or fresh water, needing only sunlight and the “waste” dissolved in the water discharged by animals and man into the environment.

Like any new business initiative initially generates costs, involving complications, false expectations, mistaken approaches, flaws in design, delays ... there will always

Multi-trophic aquaculture must, therefore, be linked to the development of seaweed farming and its subsequent economic upgrading, at least in sectors such as human and animal food

be naysayers, those who are suspicious and jealous lurking around ready to throw a spanner in the works. But if the idea is good, simply going of how it has developed, as a result of knowing how to learn from mistakes and not lose heart, there will come a time when the road is downhill from here on, and we all want to take it. So we have to keep going, no matter what.

The oceanographic, geomorphological, climatic, biological and socio-economic

conditions of Galicia are, undoubtedly, the best in the country for the full expression of Integrated Multi-trophic Aquaculture.

Moreover, we have experience in many aquaculture techniques and have also pioneered the development of farming techniques and the commercial exploitation of marine macroalgae food. Galicia is the best scenario for “brainstorming” in multi-trophic aquaculture, although not without difficulty, the conditions are in place and there are biological resources, human and

The oceanographic, geomorphological, climatic, biological and socio-economic conditions of Galicia are, undoubtedly, the best in the country for the full expression of Integrated Multi-trophic Aquaculture

technical resources to surmount almost any type of test. To check on this, one only has to read this book carefully.

Therefore, we can be leaders in the development and establishment of multi-trophic aquaculture systems which, and this is an open secret, are the future for aquaculture as a profitable, diverse and environmentally friendly activity.

javier.cremades@udc.es

Agriculture and aquaculture

Photo: Jorge García



Juan Manuel Salinas Morrondo received his B.A. in Biological Sciences at the University of Navarra and, since 1975, works at the Spanish Institute of Oceanography (IEO). He also specializes in R&D and is a specialist in seaweed farming. Initially, he worked in the assessment and control of the industrial exploitation of natural fields of algae and the development of farming techniques for agarophytes. Since 1994, he is responsible for the Algae Plant at El Bocal IEO, Santander. He has participated in R&D, both nationally and internationally, and has patents and publications on farming and applications of algae. His work has focused on seaweeds of economic interest through the development of projects of an industrial and institutional. Currently, he is working on growing techniques, both outdoor and indoor, algae used in feeding.

Although the definitions given by technical dictionaries indicate that agriculture and aquaculture are strikingly similar, their development could not be more different. Agriculture allowed man to move out of the Palaeolithic and start transforming the landscape, ecology, economy, technology and socio-political aspects that has continued until today. In contrast, aquaculture does not, for many reasons, involve the social importance of agriculture.

However, in parallel with agriculture, albeit marginally, techniques were developed for a proto-aquaculture, based on catching and ongrowing, mainly fish and in confined environments, which allowed for a diversification of diets and the development of an incipient economic niche, but without addressing the fundamentals of farming, such as knowledge of the life cycle, selection of species and others.

Fish farming ponds were developed both in the Far East and Central Europe, reaching a peak from the Middle Ages onwards, but it was not until the mid 19th century when the

This asynchrony between agriculture and aquaculture has led to there being a technology gap in the latter of over 10,000 years

first scientific work aimed at controlling the life cycle and reproduction of some fish (mainly salmonids) began. Also, but in an empirical manner, simple techniques were developed for what is now known as polyculture with compatible, complementary and economically exploitable species. This latter circumstance, without realizing it at the time, brought us closer to IMTA (integrated multi-trophic aquaculture) farming, which we will refer later.

This asynchrony between agriculture and aquaculture has led to there being a technology gap in the latter of over 10,000 years, during which man has learned to select and farm a large number of species, and to develop such a diverse range of techniques of production and processing. But however, in this period, the development of the technical fundamentals of aquaculture occurred very slowly by being outside of any socio-economic pressure that would have boosted it.

But the increase in fish consumption and the gradual depletion of fish stocks led to an urgent demand for solutions, and in this context aquaculture came into view committed to solving, in the shortest possible time (barely 50 years), what man had taken several millennia to solve for agriculture.

Perhaps this pressure has occasionally forced technicians to take some actions lacking in sufficient forethought. The simple transposition of concepts from agriculture to aquaculture has caused dysfunctions in

their development, since it is difficult to take board concepts, with all their complexity, such as farming in volume as opposed to surface farming, the presence of continuous gradients, the environment as a simple support or as a vital element, or something that is unthinkable in traditional agriculture: a circulating medium.

Mentally, we are farmers and ranchers attempting to restructure ourselves as farmers. Proof of this, and in contrast to agriculture, is that much of the development of aquaculture depends on solving the problems that it generates. So, over the coming years, we will have to test techniques and protocols to solve problems such as waste from aquaculture installations, recirculating water quality, energy saving, optimization of production systems and so on.

In this context, IMTA cultures will probably entail the most original contribution of aquaculture to food production technologies. The use, in a confined environment, of several trophic levels to take advantage of energy as byproducts of intensive fish aquaculture, with industrial

It is not difficult to imagine, in the near future, aquaculture complexes designed and operating under the multi-trophic concept, in which some of the food will be produced within the system

and environmental benefit, is an original approach, unique and revolutionary in onshore production, and although the concept has always been present, we have not been able to address its application scientifically until the end of the 20th century.

For the aquaculture technicians of the future, it will be their duty to assume that waste products are a source of energy that we are obliged to make use of that will allow us to reap additional benefits while preserving the farming and natural environment. Having accepted the concept of IMTA farming, it will be essential to research into the different models, selecting the most suitable species to study the balance of biomass and production in the different trophic levels, find synergies between the different production systems, and so on.

It is not difficult to imagine, in the near future, aquaculture complexes designed and operating under the multi-trophic concept, in which some of the food will be produced within the system, and in which there will be no environmental impact since nothing strange would be poured into the natural environment.

There is no doubt about the fact that the society that makes the most progress in this original concept will take on a dominant technological position in the development of 21st century aquaculture.

IMTA, a sustainable management model



Sergio Devesa (1953), a PhD in Biological Sciences from the University of Santiago de Compostela, currently holding the position of CEO at the company Aquacría, a fish farm located in Pontevedra (Pontevedra), specializing in rearing turbot and sole. Since the early 1980's, he has also taught at university and in higher education, related to research and the industrial production of flatfish, which is his main line of work. He regularly participates as a speaker at seminars and other calls related to marine farming, particularly with regard to fish farming. His career in the aquaculture industry has developed from 1980 to today, as an external consultant, coach and also as CEO of some major energy companies operating in Galicia.

Over the past 30 years, which is roughly the time covered by industrial flatfish farming in Galicia, my professional career has been geared mainly towards innovation. I attribute the interest taken by the Marine Research Centre (CIMA) and the University of A Coruña (UDC), in the sense that it collaborates with the National Marine Aquaculture Plan JACUMAR in "Integrated Aquaculture: a pilot experience for the development of multi-trophic farming systems, 2008-2011", to this criterion and also to the circumstance that the Aquacría installations have been the first in this region to work with a closed circuit seawater circulation system for producing turbot and sole,

On other occasions, I have conducted experimental work at the CIMA, the first of which being related to farming turbot industrially, an activity that is my main line of work since the 1980's.

The IMTA experience at Aquacría is set out to test the feasibility of diversifying production in a closed circuit fishfarming plant and, thereby, improve water quality.

The first contacts to propose this work were Salvador Guerrero, a biologist at CIMA, whom I have known for over 20 years, and also with Professor Javier Cremades, from the UDC. In the initial stages of this work, Eladio Santaella, the Spanish Institute of Oceanography in Madrid also took part.

One of the main attractions for Aquacría has this experience is the idea of using seaweed as a biofilter in the closed circuit installations this farm. And because of what it is to improve water quality, as well as economic return, the joint decision was that the species most suitable for this purpose was the *Saccharina latissima*, an alga with nutritional value sold in Galicia.

This species was supplied by the macralgae plant headed by the biologist, Juan Manuel Salinas, at the Spanish Institute of Oceanography in Santander.

Several species of mollusc filter feeders were also integrated into this experience. Space and the supply of water from fish farm effluent were provided by Aquacría. Farming kelp in the fish farm effluent, according to data obtained to date, proved to be viable.

REGULATIONS AND FUTURE

Integrated farming systems, despite the spread in the aquaculture industry in several countries, in Galicia still lack the administrative regulations necessary to meet the demand of its application. In this respect, there is a complex job to do, which would ideally involve scientists, companies and governments, so that their contents would be acceptable to all.

With respect to industry's receptivity to IMTA, I would comment that the potential is great at the Aquacría installations with water

recirculation since we have enough space to set up other circuits since those already in place are experimental.

I also note that the combination of different trophic levels of species has, for scientists working in the industry, a highly suggestive power.

Finally, available data indicate that there have been positive results with seaweed, molluscs, anemones and polychaetes, all commercial species in a turbot farm on land. The work presented by Guerrero, Cremades and Salinas, among others, under the call by MARCUBA in the 2009 based in Havana, provides a wealth of information about that experience.

The support involved in the participation of the Spanish Ministry of the Environment, Rural and Marine Affairs, through the National Advisory Board for Mariculture (JACUMAR), the Regional Government of Galicia, via the CIMA of the University of A Coruña and the Spanish Institute of Oceanography, as well as administrations and companies throughout the Spanish state, collaborate with this Plan, ensuring consistent results that will certainly be usable in the medium and long term in fish farming and intensive farming of bivalve molluscs.

The Sea, source of inspiration and wealth



Antonio Muiños (1962, Santa Maria de Vigo, Cambre, A Coruña), studied at the Faculty of Law, Santiago de Compostela and, in 1982, founded Fungicultura Muiños, specializing in farming, processing and marketing mushrooms. This industry developed research with universities and technology centres.

In 1998 with his wife, Rosa Maria Mirás Antel, he set up Porto-Muiños, a pioneer in farming marine algae for human consumption. The industry made a constant effort in R&D+i, and the company is regularly present at forums and shows. In 2009, he created the Porto-Muiños Cuisine Class.

Porto-Muiños has been awarded the 2011 Biodiversity Foundation award, in the Entrepreneur category. The company is actively involved in studies aimed at a sustainable exploitation of the resource and conservation of marine biodiversity.

For the company Porto-Muiños, Galicia's sea is a source of wealth and inspiration and, for these reasons, all of us working in this industry have respect and affection for it. One of the main premises that guides our development is to be respectful with the environment that gives us the products we produce and distribute.

As is known, our company has made a firm commitment to developing seaweed cultures of nutritional interest. We are not biologists and little do we understand of trophic levels and other concepts that scientists give much relevance to; but what we do understand, use plain words and everyday examples, that seaweed cultures are like grass: they live off the sun and the manure that we fertilize them with and, thus, becomes a circle of life and nothing is left over. Everything is used to generate diversity and wealth.

The business activity of Muiños Porto has always been oriented to following the now classical strategy of the three Rs: reduce, reuse and recycle. Nowadays we can not afford to throw anything away, let alone pollute our environment. Therefore, we have

Porto-Muiños business has always been oriented to following the now classical strategy of the three Rs: reduce, reuse and recycle

developed ingenious methods to reuse sea urchin shells and have also researched into giving value and making use of resources so far underutilized. This includes discards from fishing, controlling marine pests through commercial exploitation by developing new products, energy efficiency of production systems and others.

For all these reasons, when our friend and scientific adviser, Javier Cremades, at the laboratory of marine algae of the University of A Coruña, suggested that we should take part in developing multi-trophic aquaculture systems, as part of a JACUMAR project, we did not hesitate for one moment to provide our administrative concessions to carry out some of the experiences. We offered our full support, especially when Cremades clearly explained to us that that, in these systems, macroalgae play a crucial role in closing the circle of recycling nutrients.

We found Integrated Multi-trophic Aquaculture to be a very interesting and creative concept, which no doubt, would help diversification and sustainability of aquaculture in Galicia and, therefore, reduce the impact on the environment and resources, being to the benefit of all those who live off and for the sea, a source of wealth that we should not spoil, in the same manner that one should never kill the goose that lays the golden egg.

info@portomuinos.com

Experiences with seaweed, clams and sea urchins



Dorotea Martinez Patiño is a researcher and head of the Marine Farming Plant in Ribadeo (Lugo) of the Department of the Rural and Maritime Environment of the Regional Government of Galicia. Since 1979, she is dedicated to mollusc aquaculture. The lines of work taking place in the CIMA in Ribadeo are oriented towards producing seed from a series of marine seafoods of industrial interest. She also researches in the wild, hatchery conditioning, spawning induction, larval and post-larval farming, seed rearing and food at different stages of cultivation. The main species in these studies are grooved carpet shell, pullet carpet shell clam, banded carpet shell and carpet shell, as well as razor shell and sword razor shell (sword razor shell, old sword razor shell and razor), donax and, in recent years, farmed sea urchin (*Paracentrotus lividus*).

My experience in hatchery farming of bivalve molluscs and sea urchin gave me first-hand knowledge of the uses of multi-trophic farming, enabling me to comment on it as an interesting system for developing aquaculture.

One of the major difficulties that arises in a nursery involves feeding the seed to achieve a certain size, because the amount of microalgae consumption is multiplied, which means a considerable increase in space requirements.

The availability of time and labour required for maintaining the seeds is yet another factor that influences these processes. This limits the ability of hatchery production, so it is of great interest to transfer the seed, with as small a size as possible, into the natural environment or other pre-ongrowing installations. This would reduce the cost of producing seed for farming.

To this end, and in the framework of experiences under the Jacumar Galicia Plan on multi-trophic farming, experiments were performed with pre-ongrowing seed reared in our installations in the effluent of an open circuit turbot farm at Punta Moreiras. Some of the initial advantages that I was able to note in this system are the availability of large volumes of water pumped with no additional cost and, in addition, a flow rich in organic matter coming from the actual activity of the fish and remains of feed. The favourable

results obtained were checked with some species of clams, specifically with pullet carpet shell and carpet shell.

Over the past few years, we are also farming sea urchin (*Paracentrotus lividus*). Feed for young urchin is based on macroalgae and, during the first months of life, soft texture macroalgae are used, which present problems of supply, since we obtain them when washed ashore and only seasonally.

In recent years, thanks to multi-trophic systems, we have used algae fed with nutrients that come from feed for fish reared in a long-line system, with species supplied by Javier Cremades (UDC). Specifically, we use the species *Saccharina latissima*, preserved in salt and then transferred to installations where juvenile sea urchin are kept and consumed as needed. Exploitation of sea urchin was high, no part of the algae was rejected and growth was significantly higher than with other types of food.

A first impression would be in the sense that the practices and systems of integrated multi-trophic aquaculture represent an energy saving, are economic and, consequently, are an improvement in the environmental management of marine aquaculture.

mptea@cimacoron.org

Foto: Javier Cremades



INTECMAR headquarters
in Vilaxoán de Arousa
(Pontevedra).



Since 2004, **INTECMAR** is the official body of the regional government of Galicia, which controls the quality of the marine environment and the application of technical regulations and sanitary requirements for sea produce. In order to comply with these tasks, **INTECMAR** is accredited by the UNE-EN ISO / IEC 17025 "General requirements for the competence of testing laboratories and accreditation standard." This organization depends on the Regional Department for the Rural and Marine Environment and, when established, it took on the competencies and functions of the Quality Control Centre of the Marine Environment (CCCMM), inaugurated in 1992.

The contribution of INTECMAR

One of the major competencies of this technological institute at regional level is to comply with the administrative regulations on the quality of production of molluscs and other marine organisms. It is also committed to contributing to protecting and improving the quality of the marine environment, for which there is a protocol that includes monitoring, control and investigation of the environmental quality of coastal waters of Galicia, especially regarding the oceanographic conditions, phytoplankton, marine biotoxins, chemical contamination, microbiology and pathology.

The monitoring network for oceanographic conditions has 42 oceanic stations distributed over the main Galician Rias and 16 coastal stations distributed along the Galician coast, where sampling is carried out on a weekly basis.

This network makes it possible to determine the physical-chemical variables of water (salinity, temperature, pH, dissolved oxygen, fluorescence, transmittance, irradiance, aromatic dissolved hydrocarbons, inorganic

and organic nutrients) in addition to phytoplankton and photosynthetic pigments.

According to the results obtained in the offshore stations of the INTECMAR monitoring network of inorganic nutrients, "the Galician rias can be considered as non-problematic areas in terms of the state of eutrophication" (M.D. Doval). This classification coincides with that made for the Ria of Pontevedra in the latest 'National Report on the state of eutrophication in the OSPAR maritime area' of June 2007.

The contribution made by INTECMAR to the Jacumar project on multi-trophic farming has been to provide oceanographic data on the rias of Arosa, Muros-Noia and Ares-Betanzos. INTECMAR has also performed the analysis of inorganic nutrients, chlorophyll and phytoplankton in water samples from experiences on land and sea, designed by the group of researchers in Galicia who have conducted experiences in multi-trophic marine farming. The INTECMAR researchers responsible for this collaboration are Maria Dolores Doval Gonzalez and Yolanda Pazos Gonzalez.

mdoval@intecmar.or

Meeting the demand for sustainable food production strategies



Ignacio Arnal Atarés is linked up via the Spanish Institute of Oceanography (I.E.O.), where he is Head of the Department of Aquaculture, since the seventies. His activity has been developed in research, in advising private and public bodies, international the management of international programmes and specialized teaching. He holds a degree in Biological Sciences from the University of Navarra (1970). His research work covers sea bream, sea bass and mullet, prawn and shrimp. In 1974, he earned the title of I.E.O. oceanographer and, in 1976, he moved to the headquarters in Santander, where he researched into the production and exploitation of grooved carpet shell clam banks in the Bay of Santander. Finally, he has been a member of the Organizing Committee and of the Scientific Committee of the National Aquaculture Conferences held in Spain.

The increasing development of our species on Earth involves the proportional increase in food requirements and, alongside that the development of larger (and better) economic and technological means to ensure our continuity on the planet. In this context, it is not surprising that mankind increasingly focuses on the seas and oceans, which cover nearly three quarters of the planet's surface. And as we focus on marine resources, the first thing to be noted is that fishing is already approaching its maximum sustainable level. Meanwhile, aquaculture is growing strongly worldwide, although with significant geographical differences.

As regards aquaculture, the ocean and marine domains have so far been hostile to the human species, but new technological developments are allowing their use, promoted by the two expansive forces of human development: the domestication of species for production and the colonization of new media (or territories) to make these productions possible.

These two initiatives (domestication and colonization), are as old as mankind, but the big difference from the old is that now both are able to apply a power hitherto unknown, on a global scale, thanks to technological development. This power is what should call for an increased responsibility when applied in order to ensure its sustainability.

Although the techniques of integrated multi-trophic aquaculture are not new, and there are traditional farms where it is widespread, especially in Asia (as in the case of fishfarming in paddy fields), the development of concepts of sustainability and the implementation of the "ecosystem" approach for activities aquaculture encourages the application of these new integrated approaches to aquaculture farms, the aim being to improve the use of foods and nutrients, reduce environmental impact and make it possible to achieve higher and better distributed social benefits.

It is, therefore, undeniable that the increase in the areas used for aquaculture production, along with the development of new production techniques, would make it possible to expand the range of aquaculture products. But however, globalization, or rather, the appearance of global markets, orientates production towards monospecific farming of a small number of species, using increasingly intensive production systems, leading to increased environmental costs (intrinsic to these production systems), even though it must be recognized that investments are made to reduce and mitigate environmental impact.

In this context, where more ecological value is given to the merits of integrated multi-trophic aquaculture, since it increases the load

Integrated Multi-trophic Aquaculture also has benefits from the social point of view, as it diversifies the risks by producing several species in different trophic levels

capacity of the farming areas, both due to a decrease in the emission of effluents per unit of biomass produced, and by the fact that a fair part of these effluents are metabolized by any of the farmed species (e.g., filter feeder molluscs or algae).

In addition to these environmental advantages, integrated multi-trophic aquaculture also has benefits from the social point of view, as it diversifies the risks by producing several species in different trophic levels, while broadening the social groups able to benefit from the activity. However, two types of fundamental questions still remain: the coupling between the various productions and the improvement of profits in order to attract investors.

As regards the coupling of the various productions, it is essential to increase knowledge about the mechanisms involved in the different farmed (internal and

interrelated) populations in order to have a sound basis for system management, based on interactions between populations and the influence of environmental conditions on population dynamics (without overlooking more practical aspects such as the definition of monitoring methods and situation indicators).

In terms of the economic benefits, they must be calculated not only in "accounting" terms, but also from a broader perspective in which the economic evaluation of social and economic aspects can be measured. This assessment could be especially considered by consumers (buying preferences), and by the regulating bodies, establishing funding for integrated multi-trophic aquaculture systems in order to compensate for their lower 'cost' environmental and social which, even though they are not noted in the company accounts, do not cease to exist.

Today, no one disputes that the health of the ecosystem in which it is integrated is the best basis for well-being and quality of living. And this, which we consider to be obvious for our species, is also the same for any other species that is part of the system.

ignacio.arnal@md.ieo.es

Experience of rearing fish/molluscs



Alejandro Guerra Díaz holds a doctorate in Biology from the University of Santiago de Compostela. His activity over the years, both in the private sector as well as in the Fisheries Administration of Galicia, has always been linked to the research and development of mollusc farming, in hatcheries and in the natural environment, for various species, including European flat oyster, variegated scallop, abalone, clam and others. He has authored numerous publications and has participated in publishing scientific literature related to research in marine farming. Since 2001, he is director of the Marine Research Centre (CIMA) of the Regional Department of the Rural and Marine Environment under the Regional Government of Galicia.

The Autonomous Regional Community of Galicia is the world's leading producer of turbot, with about 7,000 tonnes per year, which means a stable stock of 5,000 tonnes of farmed fish biomass. Open circuit on-growing plants located on land require huge volumes of sea water to operate, which is subsequently channeled back into the sea. These effluents contain large amounts of suspended or dissolved organic matter from feed waste. Part of this particulate organic matter can be used as food for bivalve molluscs.

In recent years, the fisheries administrations in Galicia and the Spanish State, the latter through JACUMAR, has promoted projects and lines of research aimed at obtaining a better use of the organic matter from the effluent in fish farms, using bivalve mollusc seed, mainly from nursery reared clams and oysters. These species act as "organic extraction" filterers for the fine particles carried by the effluent. Other uses have been looked for for the thick waste in the form of silt that is deposited in fish farm settling tanks, including some uses in forestry and agriculture.

The development of these projects was possible with the essential collaboration of some of the companies in the fish farming sector

The Galician coast supports a strong shellfish activity, based on collecting molluscs in the intertidal and subtidal areas. The groups involved in these tasks mainly comprises women, currently numbering over 3,500, while shellfish collecting from boats mainly involves men and operating from around 3,000 small boats. Apart from these figures are the more than 1,100 farming parks in Carril, inside the Ria of Arosa, in the province of Pontevedra.

This important, traditional social and economic activity depends on farming commercial mollusc seed, mainly clam. The seed comes from recruitments of natural populations or is provided either in the form of seeding, with juveniles from hatcheries and seedbeds. One of the possible answers to the high and increasing demand for seed for on-growing and rearing activity posed by shellfish collecting is the work and trials aimed at using effluent from fish farms to establish seed pre-on-growing systems that are simple, efficient and profitable.

These projects were developed thanks to the essential collaboration of some of the

The success of these integrated farming projects is largely linked to the operational practices of the fish farms being developed in line with the handling and farming of molluscs

fish sector companies, particularly Insuiña, a pioneer farm in ongoing turbot, whose effluent, adapted for this purpose, was used for developing tests on pre-on-growing seed of different species of commercial bivalves, provided by the company Remagro, which has an industrial mollusc hatchery. The composting testing company, Ecocelta, developed usage tests for bulk organic waste, once compacted and adequately processed.

The success of these integrated fish-mollusc cultures, as regards on-growing molluscs, is largely linked to the operational practices of the fish farms being developed in line with the management and farming of molluscs. In short, through these processes of knowledge generation on a semi-industrial scale, it is possible to create systems to integrate two aquaculture production plants: for fish and molluscs. With this synergy, the production of mollusc biomass is promoted, while driving natural bioremediation systems to reduce the organic content of the effluent from the fish farm, which improves water quality.

director.cima@cimacoron.org

New Perspectives in aquaculture development



Fátima Linares Cuerpo, a researcher attached to the Marine Research Centre (CIMA), has been developing her work in the field of aquaculture since 1980, mainly in the area of farming new species of marine fish. For several years now, her work has focused primarily on the field of nutrition at different stages of development of fish in intensive farming as well as on octopus. She is currently manager at the CIMA responsible for programmes related to obtaining specific and sustainable feed for common sole and sea bream besides developing paralarvae diets for octopus. She was Director General of Innovation and Development at the Regional Department of Fisheries and Maritime Affairs (now the Ministry for the Rural and Maritime Environment), during the period 2005-2009 and, as such, has participated in the initial project development of multi-trophic cultures.

The National Multi-trophic Culture Plan, promoted and financed by the Advisory Board for Marine Farming (Jacumar), arose at the initiative of Andalucía and is also responsible for coordination. It involves research centres and companies in Andalusia and the Balearic Islands, Murcia, Canary Islands, Catalonia and Galicia. It mainly sets out to evaluate the implementation of integrated multi-trophic farming systems in aquaculture in Spain, in order to demonstrate its feasibility and environmental and economic efficiency.

The notion that this project opens up new possibilities for aquaculture in Galicia, which originated in 2007, led to the considerable interest in support it through the Department of Fisheries and Maritime Affairs. Today, this support has continued through the Regional Department of the Rural and Marine Environment.

The possibility of making filtering species, assimilating species and producers compatible, which act as biofilters, is not a new idea. Recently, at the European Congress on Aquaculture, held in Porto

In the Galician rias, over 600 species of macroalgae coexist, and now some twenty or so are marketed primarily as human food products

in 2010, presentations were made on the development of real models applicable to different species and different ecosystems. After an extended period of research, results were presented on a pilot scale, and it is expected that some multi-trophic farming models will be adopted on an industrial scale by 2012.

Galicia has excellent conditions for the development of aquaculture because of its geographical features, the waters and for having the appropriate technological infrastructure for aquaculture research and training of skilled labour.

While Galicia is, today, one of the world's leading producers of mussel and turbot, it also has a considerable importance, from a social and economic viewpoint, in terms of bivalve farming in the intertidal zone. New species for farming can and should be developed while bolstering existing ones. Within this context, we may consider seaweed farming as an emerging trend that is beginning to be important in Galicia. In the Galician rias, over 600 species of macroalgae coexist, and now some twenty or so are marketed primarily as human food products. It is, therefore, a progressive development that may lead to an increase in the number of species with commercial value. Furthermore, it is possible to add other cultures, including anemones or polychaetes. One of the main objectives of this project is to study the possibilities of farming new

species from different levels in the trophic chain.

A EUROPEAN STRATEGY

The European Commission defines the following as targets in the "Communication on the strategy for the sustainable development of aquaculture":

- Create long-term secure employment, particularly in areas dependent on fishing.
- Increase the rate of growth of aquaculture production in the EU.
- Solve conflicts arising from the space that now hinders the development of aquaculture.
- Ensure compliance with environmental standards.

The criteria for sustainability in aquaculture inevitably entails supporting the lines of research that generate the diversification of cultures and the use of systems and practices that respect the environment, such as water recirculation involving energy savings. In short, the adoption of more effective systems from the point of view of energy, the environment and the economy.

Integrated aquaculture aims at the integral use of natural resources and provides a new approach from the environmental point of view, by setting out to mitigate the possible

effects of aquaculture production processes and also with regard to the capacity of the production systems.

In the field of the European Community, various directives relating to marine farming and waste from aquaculture have been established. As an example of this legislation, which has been gradually transferred to the Spanish state and to the autonomous region of Galicia, there is one that defines the concepts of sustainability and waste treatment. This is the Order of 11th May, 2001, from the Regional Department of the Environment, regulating the basic content of the studies to minimize the production of hazardous waste that are to be submitted by authorized producers of waste (Official Gazette of Galicia, No. 97, 22nd May 2001).

An appropriate model for a correct transfer of results to the production sector and a contribution to the development of aquaculture in Galicia derives from the approach of the project, involving a clear collaboration between researchers, companies and administrations where the task of making the results known has an important role. Furthermore, the collaboration of companies from different centres contributes to regional communities contributing to drawing efforts together in developing these aquaculture systems in the Spanish State.

A future option for aquaculture



José Carlos Macías is a technical advisor on fisheries and aquaculture matters, with over 15 years of experience in the sector. He began in a private company and has subsequently spent more than a decade working for the Fisheries Administration in Andalusia, as a technician and head of department. During that period, he has developed important lines of work on strategic aspects aimed at consolidating the aquaculture industry, such as the location of areas suitable for integrated aquaculture. He currently works as advisor-consultant for national and international organizations.

The background to this project harks back to 2003, when a number of circumstances that were important for the development of aquaculture in Spain and in Europe converged. Among them was the impressive growth of the sector in countries such as Greece and Turkey, there was more and more insistent talk of the associated environmental effects. On the other hand, the arrival on the market of large amounts of product began to pose a risk for the economic balance of industries in countries with lower levels of production, such as Spain, France and Italy.

It was in this context that the conference “Aquaculture Europe 2003 “Beyond Monoculture” was held in the Norwegian town of Trondheim, where experts from around the world presented their experiences developed in several countries in multi-trophic farming.

Adapting the concept to our status and situation, integrated aquaculture could be broadly defined as the combination of different marine cultures, using species of several taxonomic groups in the same physical system or production facility, in order to improve the use of system resources and improve the environmental quality of the environment.

It should be borne in mind that multi-trophic cultures already existed, in a sense, in the wild in the wetlands plants in southern

Spain, and that there is a certain level of knowledge about this type of aquaculture. At institutional level, the project approved by JACUMAR was launched to generate the project in 2007.

Some of the considerations prior to the design of the project were:

- Type of aquaculture systems and species that develop in the autonomous regions of the Spanish State that were to take part in the project.
- Dual purpose and objectives: to improve the environmental management of farms where it was to be implemented and, secondly, to promote the economic bolstering of companies by diversifying their production.
- Diverse horizons in terms of space and time: six regions with conditions for farming, highly diverse species and systems, which led to the project having a considerable diversity of experiences. The programme period was set at 3/4 years in order to develop a more than one experience per working group.

Farming molluscs associated with fish, both in onshore installations and in installations at sea, is a viable combination industrially speaking and is of economic interest

- Preferably, and where possible, experiences were to be conducted with three trophic levels that represent the three taxonomic groups of fish, molluscs-crustaceans and macroalgae.

The overall objective was “to evaluate the application of integrated multi-trophic farming systems in aquaculture in Spain.”

From the methodological point of view, the project had an initial stage where the different experiences developed in each region were defined. In the case of Andalusia, which also acted as the Steering Group for the plan, it was proposed to manage two integrated farming cultures on land and a further two offshore.

Between 2009 and 2010, the scheduled experiences were put in place, with giant oyster and shrimp associated with fish farming facilities on land. Giant oyster and mussel were also worked with, associated with fish in cages, while a short test was conducted with macroalgae.

Although the final results will be presented

The presence of complementary cultures in an installation lead to an additional, specific line of work that needs to be analyzed in detail in order to make this option feasible from an entrepreneurial point of view

once the plan is completed in December 2011, preliminary results have been very positive and have shown the existence of real options in diversifying and/or supplement the main cultures in aquaculture facilities.

OTHER REFLECTIONS

Farming molluscs associated with fish, both in onshore installations and in installations at sea, is a viable combination industrially speaking and is of economic interest.

Macroalgae associated with fish farms pose a major challenge from the standpoint of the use of certain species.

Undoubtedly, the presence of complementary cultures in an installation lead to an additional, specific line of work that needs to be analyzed in detail in order to make this option feasible from an entrepreneurial point of view. The development of this type of culture must be accompanied by a participatory process in order to develop regulations regarding any changes and extension of culture authorizations, sanitary controls, use of water and others.

Finally, multi-trophic marine culture systems are a great opportunity for achieving the sustainability of aquaculture, because they lessen their environmental impact and enable companies to have other products by diversifying.

A food production model



Marina Fernández Lora holds a degree in Marine Sciences from the University of Cadiz, where she later completed her studies with a Master in Fisheries and Aquaculture. Over the last eight years, she works in aquaculture in the private and public sectors. Currently working at the Agency for Agricultural and Fisheries Management of Andalusia (AGAPA) under the Regional Government of Andalusia Agriculture and Fisheries Department, a body that takes part in and coordinates the Jacumar National Integrated Multi-trophic Aquaculture Plan. Additionally, she is involved in cooperation projects in marine culture, backed by her training, which includes having completed a Master in Cooperation for Development and Management of Cooperation Projects.

Integrated aquaculture has many definitions and the concept proposed by the FAO is of particular interest: an aquaculture system that shares resources, water, food, management and use of common infrastructure within the same or associated activity with other activities such as agriculture, agroindustry, livestock and others. This definition includes aquaculture as a type of food production which, when analyzing its characteristics, has been and is used in many parts of the world by small producers and on a small scale. The suitability of this practice is based on diversification arising from integrating cereals, vegetables, fish, trees, farm animals and others, providing them with a stable production, efficiency in the resources used and conservation of the environment.

It is interesting to reflect on these models of food production and how, paradoxically, they are used in regions with more limited resources (water, land, electricity and others), and means (technological and economic), and yet with a community concept responsible for the use of available resources.

Although the scales are different in this respect, and extrapolating this to our reality, the development and sustainability of marine aquaculture includes, among other things, reviewing the practices mentioned above as regards the efficient use of resources. It is undeniable that we

are going through a process of significant political, social and economic change and, consequently, there will be numerous reforms, one of which is bound to be changes in the systems of food production. Right now, aquaculture in the medium and large scale, as a food production system, has an opportunity to adopt guidelines that will shape the dominant trend in terms of food quality, efficiency in the use of resources, environmental friendliness and social responsibility.

In general terms, this trend coincides with the main characteristics of multi-trophic or integrated cultures, which propose the sustainable growth of aquaculture through the efficient use of natural resources and the improvement of water quality, incorporating species from different trophic levels (fish-molluscs-algae), which remove organic and inorganic compounds from the main culture. It should not be overlooked that IMTA promotes the competitiveness of aquaculture production by diversifying species and improving the image of the

The development and sustainability of marine aquaculture includes, among other things, reviewing the practices mentioned above as regards the efficient use of resources

industry and aquaculture, through the connotations of environmental sustainability, which embrace the concept of integrated aquaculture.

For this reason, it is time to work on four aspects in order to revitalize and consolidate multi-trophic farming:

1. The legal and regulatory support of the administration so that the development of these practices in aquaculture production become common practices.

2. The initiative of the business sector motivated by existing success stories.
3. A commitment from the researchers to focus their studies on applied research that can be transferred to aquaculture companies.
4. The interest of society in promoting responsible food production systems, from the social, economic and environmental viewpoint.

marina.fernandez.lora@juntadeandalucia.es

Innovation applied to production: integrated aquaculture



María del Mar Agraso Martínez (Cadiz, 1980), holds a degree in Marine Sciences from the University of Cadiz, where she completed her Master studies in International Fisheries and Aquaculture. She has worked for over 8 years in the private and public sectors in planning and management of aquaculture, promoting new private initiatives and optimizing production management in technical, economic and environmental aspects. She is currently working at the Technological Aquaculture Centre in Andalusia, CTAQUA (www.ctaqua.es), a body whose responsibilities include promoting competitiveness, innovation in aquaculture companies and meeting business needs through the development of research applied to the different production processes.

In order to lay the groundwork for the future of aquaculture at EU level, in 2009, the European Commission published the document “Building a sustainable future for aquaculture: A new impetus for the Strategy for the Sustainable Development of European Aquaculture” [COM (2009)]. This community approach is based on the principal axes that should guide the development of aquaculture in the years to come: promoting competitiveness, laying the foundations for sustainable growth and improving the image and governance.

The development of these aquaculture systems depends on a productive and economic strategic planning process, making it possible to achieve business objectives

In terms of promoting competitiveness and diversification, the Commission proposes the development of the sector through innovation. To achieve sustainable growth and respect for the environment, there are different proposals including new strategies to improve compatibility between aquaculture and the environment and provide a clean medium for marine farming and water of the highest quality, aimed at ensuring the health of aquatic animals as well as the safety and

quality of products, especially in the case of molluscs.

In this regard, it should be remembered that the productive interests and the economic results of fish farming companies depend, to a greater or lesser extent, on the quality of the ecosystems in which they operate. Moreover, the regulations and environmental regulations are increasingly demanding, in the same manner as social awareness regarding these matters. The marine farming industry has, in recent years, dramatically increased the implementation of corrective and protective measures designed to minimize, among other things, the impact generated by the activity.

These circumstances have created the need for further work to optimize production processes and applied innovation. In this regard, introducing technology has advanced in technifying food supply and improving culture management, as well as improving company competitiveness, focusing on production aspects and the development of new activities that will be sustainable, which is precisely where integrated multi-trophic aquaculture finds its framework. IMTA is defined as a type of aquaculture designed to supplement the main fish culture with other species that use the waters of the facility, rich in nutrients for their proliferation and growth.

The use of integrated farming systems shows a number of advantages that are intrinsic to the process itself and the place where it is developed since, among other things, it makes it possible to maximize and make the most of natural areas for cultures which, as is known, are increasingly limited and restricted. In this regard, it is noted that the coasts of Spain have an outstanding wealth of aquatic biotopes: salt marshes and sea in the South of Spain, rias in Galicia, confined areas and marine areas. All these environments are ideal for biotechnological use and for the production of commercial species, including molluscs, crustaceans, echinoderms and algae. Furthermore, IMTA has other advantages: the sustainable development of complementary productive activities, integrated in the main culture system while reducing the potential environmental impact on the environment, besides increasing the profitability of production.

By way of a conclusion, it should be noted that the development of this innovative activity will make it possible for companies to position their products competitively in consumer preference segments, which include valued aspects such as quality and diversity. It is also considered positive for them to have been farmed on a sustainable basis.

Finally, these initiatives in the field of IMTA, will promote a better image and social acceptability of aquaculture in response to environmental, cultural and economic aspects.

In any case, the development of these aquaculture systems depends on a productive and economic strategic planning process, making it possible to achieve business objectives and, therefore, to strengthen the future prospects of these companies.

mm.agraso@ctaqua.es

Some examples of unsustainable aquaculture



John Bayes is director of Seasalter Shellfish, since 1970 and is a member of the Shellfish Association of the United Kingdom. He is considered to be a world authority on farmed bivalves.

His company has developed systems for bivalve hatcheries and seedbeds in Europe, America and Asia. Its production strategy includes three-dimensional system (up flow system), which allows for very high seed densities in confined spaces.

In the oyster and clam hatchery that the company has in Reculver, (United Kingdom), all mother units, algae and seed operating in an open circuit system, using heat exchangers between water input and output, which entails energy efficiency, reducing space and simplifying the installation.

Much of the fish farming in the Western world uses fishmeal, from small fish to make feed for other fish. There is a different case: the rearing of ducks in Egypt, where feces are used to encourage the growth of phytoplankton. From the point of view of energy supply, feeding within the same link in the food chain using fish to feed fish involves a loss of biological efficiency of 80%, derived from the metabolic processes.

Clearly, the demand for protein for human consumption is on the increase, and a major source of supply comes from fish farming. In my opinion, the only acceptable diets for farmed fish are coming from fish discards, also called “rubbish fish”, which goes largely untapped, despite being an important part of the catches.

The effects of overfishing on marine ecosystems are increasingly evident and disturbing. In the North Sea, after authorizing the Danish fishermen to catch eels and small fish of the herring family, food normally consumed by seabirds practically disappeared, with the consequent reduction of their populations. Another example: overfishing is the origin of the proliferation of jellyfish and their concentration in different locations of the world's oceans. This proliferation results in fishing nets becoming clogged and in Japan, has led to the sinking of small fishing boats or the loss of nets, to prevent the boat

sinking (1). Another negative consequence is that toxins from the tentacles of the jellyfish poison the fish, making it unviable for human consumption. Other negative effects were also found in fish farms: recently, the only salmon farm in Northern Ireland lost all its production, due to the proliferation of jellyfish, which has led to a mortality of more than 100,000 salmon and, thus, the loss of millions of euros (2).

Apart from these examples, which may not be important to anyone who is not aware of the importance of ecosystems and biodiversity, there are also others that pose huge economic losses, in euros, for fishermen and farmers. Clearly, when you eliminate a species from an ecosystem, its place is taken up by others that can cause new problems. In fact, this is not really a question of agreeing or not, as there is evidence demonstrated in various scientific publications.

(1) **A 10-tonne fishing boat sunk by jellyfish.** The Telegraph. 2nd November, 2009. By Julian Ryall in Tokyo. <http://www.telegraph.co.uk/earth/6483758/Japanese-fishing-trawler-sunk-by-giant-jellyfish.html>

(2) **The only salmon farm in Northern Ireland has been destroyed by an invasion of jellyfish.** 100,000 salmon valued at one million pounds, have died. The Independent Nature. 22nd November 2007. By Deric Henderson. <http://www.independent.co.uk/environment/nature/jellyfish-invasion-wipes-out-fish-farm759008.html>

seasalter@globalnet.co.uk

The challenge of a sustainable aquaculture



Juan Luis Barja Pérez, holds a degree in Biology from the University of Santiago de Compostela (USC), and is Professor of Microbiology at the Department of Microbiology and Parasitology, CIBUS, in the Faculty of Biology and Institute of Aquaculture of the USC. He also has a Master in Biology and a PhD in Microbiology from the same Faculty. He has researched for the Department of Microbiology, University of Maryland, College Park, MD (U.S.A.), between 1979 and 1980, and also at the Department of Microbiology & Immunology, Medical School, Oregon University (U.S.A.) in 1981.

Aquaculture is an increasingly important activity worldwide, among other reasons because of its favorable impact on employment and ability to generate wealth in coastal communities. Furthermore, commercial fisheries are suffering a major setback, partly due to overexploitation. Meanwhile, aquaculture production has grown dramatically, rising to almost 50% of world fisheries, according to FAO estimates.

The challenge at present is the sustainability of aquaculture, which includes fish, molluscs,

The mixture (integration) of organisms from different trophic levels mimics the function of the natural ecosystem

other invertebrates and algae. Improving various aspects (growth, reproduction, health, food, waste management, etc.), in the production of farmed species is a prerequisite for improving efficiency and ensuring this sustainability.

At present, compared to classic monoculture (mussels in the Galician estuaries or salmon in Chile), which involve the inherent risk of being susceptible to commercial problems and to diseases, the concept of integrated multi-trophic aquaculture (IMTA), which involves organizing a polyculture in a given

area where very different species are used:

1. Some need to be fed (fish).
2. Others grow using organic matter in suspension, mainly plankton (as in the case of bivalve mollusc filter feeders) and
3. Others use inorganic matter (as in the case of algae). There is even a fourth level, detritivores, (as in the case of many crustaceans), using the remains from all the above.

The mixture (integration) of organisms from different trophic levels mimics the function of the natural ecosystem, assuming that they all play their part in the recycling of organic matter while contributing to an important aspect of future aquaculture, which would increase the diversification of cultures.

Other aspects to consider for IMTA are the sanitary issues. The experience built up over the years indicates that fish pathogens are not usually pathogens from molluscs or other invertebrates and vice versa.

With the improvement of feed characteristics, the widespread use of vaccines has led to a drastic reduction in the use of antibiotics and antiparasite treatments, and the establishing of rigorous sanitary checks, there has been a qualitative leap towards such necessary formulas entailing the sustainability and profitability of the aquaculture industry.

juanluis.barja@usc.es

Assessing the potential of bioremediators to utilize waste products from intensive aquaculture systems using a mass balance model



Ingrid Lupatsch holds a degree in Fisheries Biology from the Christian Albrechts University Institute of Marine Science, Kiel, Germany, and has a PhD from the Institute of Animal Nutrition, University of Bonn, Germany. For over twenty years, she has worked at the National Center for Mariculture in Eilat, Israel, and since 2007, participates in the research group of the Research Centre for Sustainable Aquaculture, Swansea University, U.K.. Her research is on basic and applied aspects of aquatic animal nutrition, in a variety of species, such as teleost fish, crustaceans and invertebrates, with emphasis on bioenergetics, digestibility, energy and the quantification of protein requirements, food formulation and the evaluation of ingredients, all designed to improve food systems and to successfully manage the waste produced by fish farms in cages and on land.

There is currently much interest in applying the principles of integrated multi-trophic aquaculture to existing intensive fish and shellfish farms by capturing waste nutrients via lower trophic level organisms, thereby reducing environmental impacts and yielding additional valuable products. Various studies have suggested the use of invertebrates or demersal fish to assist in the task of sediment remediation.

The main concept of integrated systems is to convert the soluble and solid waste products of the main culture organism (fish or shrimp) into additional valuable products thereby reducing environmental impacts and increasing the sustainability of the farming operation. In such a system, species are cultured separately permitting intensification, optimization of production and better control of nutrient flow and uptake.

However, to increase the profitability of the overall production, it is necessary to predict the amounts of the nutrient fluxes between the various organisms meaning the uptake, the retention efficiency and deposition of new biomass. This can be done by a nutritional approach that enables us to

quantify the necessary energy and nutrient intake of each species and to predict retention efficiencies as well as the output of solid and dissolved nutrients. Using known feed inputs as carbon, nitrogen and phosphorus, a total nutrient budget can be established using the following mass balance:

$$\begin{aligned} & \text{total food input} \\ & = \text{retention (growth)} \\ & + \text{faeces (solid waste)} \\ & + \text{excretion (dissolved waste)} \end{aligned}$$

Each part of this equation is quantitatively measured with the exception of the dissolved waste, which is calculated in the model as the difference.

This approach has been put to the test in a field study using grey mullet *Mugil cephalus* as a bioremediator to reduce the benthic impacts of sea bream cage farms in the Red Sea. This study showed, that grey mullets, when kept in benthic enclosures beneath the fish cages, effectively removed 4.2 g organic carbon, 0.70 g nitrogen and 7.5 mg phosphorus per kg mullet per m² per day from the organically enriched sediment. Thus deployment of grey mullets may be an efficient means to improve the quality

of sediments below intensive fish cages and since grey mullet has commercial value in many countries, a potential source of an additional farmed product is provided (Lupatsch *et al.* 2003).

A similar approach was employed to regenerate the organic waste of a land based sea bass (*Sparus aurata*) farm using marine polychaetes. Detritivorous polychaete worms are farmed commercially as live bait for sport angling and most recently as an ingredient in feeds for finfish and crustacea. Such polychaetes, including the king ragworm, *Alitta virens*, can utilize detritus and decaying organic matter and may thus potentially serve as bioremediators. A study was carried out to evaluate the efficiency of production of *Alitta virens* when grown solely on solid waste collected from a fish tank compared to a pelleted formulated feed. Results showed, that to produce 1 kg of *Alitta virens* solely on waste sludge a total of 22.6 MJ gross energy (= 502 g carbon) and 387 g crude protein (= 62 g nitrogen) are needed compared to just 12.4 MJ gross energy and 286g crude protein when grown on pelleted feeds.

To put this into the perspective of an integrated aquaculture system the culture

of European sea bass (*Dicentrarchus labrax*) might be used as an example. Assuming, that 1.40 ton of feed is needed to produce one ton of sea bass, the solid waste output is predicted to be 74kg carbon and 8 kg nitrogen. Based on the above estimates we can conclude that up to 129 kg of *Alitta virens* could be produced as a valuable by-product by feeding on particulate waste originating from the production of 1 ton of sea bass.

In summary, such a treatment process creates a positive incentive for the fish farmer, who could gain an additional income from the capture of nutrients by the cultured by-products while simultaneously reducing nutrient output to the environment.

REFERENCES

Lupatsch I., T. Katz and D.L. Angel (2003). Assessment of the removal efficiency of fish farm effluents by grey mullets: A nutritional approach. *Aquacult. Res.*, 34: 1367–1377.

i.lupatsch@swansea.ac.uk

Aquaculture as an answer to dietary imbalance in westernised societies



Clive Askew farmed the first batches of *Crassostrea gigas* in Great Britain in the 70's and also analysed the economic feasibility of farming oyster with seed produced in hatcheries. He worked in this field in the U.K. and Spain, and later created the consultancy, Marine Culture Technology. From 1991 to 2008, he was Deputy Director of the Shellfish Association of Great Britain (SAGB), and also a founding member of the European Mollusc Producers Association (EMPA-EMPA). Another of his lines of work was developed in the field of omega-3. He continues to advise in aquaculture and also works as a fishing consultant for the Fishmongers' Company of London.

It has often been noted that societies which have a high proportion of seafood in the diet suffer much lower levels of many of the diseases which we now associate with the 'western' diet. Heart disease in particular is very much lower in Japan than in the west. The Mediterranean diet is typified as being high in mono-unsaturated oleic acid, from olive oil. It also includes good intakes of fruit, nuts and seafood, the latter being the only source of ready-formed long chain omega-3 polyunsaturated fatty acids (PUFAS), principally EPA and DHA. Whilst humans can elongate short chain fatty acids into these essential long-chain forms, the process is limited and is poorly quantified. A further source of dietary imbalance is the presence of high levels of short-chain omega-6 fatty acids in the modern western diet, originating from many oil seeds such as sunflower, corn-oil and soy oil but also present in many animal feeds. These suppress people's ability to elongate omega-3s, because they compete for the same elongation enzymes. So the requirement for ready-formed marine EPA and DHA is further increased in the western diet. The reality is, however, that for much of the population, seafood is a minor component in the diet and for many individuals it is completely absent.

So deficiency of marine omega-3 PUFAS represents a major imbalance in the modern western diet and has been exacerbated

by the rapid increase in consumption of omega-6 fats over the past 30 or so years. William Lands (1) demonstrated a powerful association between risk of coronary heart disease and excess omega-6 in the diet.

Eric Brunner et al in 2008 (2) pointed out the conflict between increasing need for seafood to meet human health requirements and the pressures on wild fisheries and marine ecosystem health. They also pointed out that the evidence base for health advice on seafood consumption remains poor. The European Food Safety Authority EFSA has recently recognised claims for EPA/DHA in maintaining normal cardiac function, normal triglyceride levels and normal blood pressure, but evidence remains equivocal on other health claims, so more evidence is needed.

Given the state of global fisheries, the only practical solution to this shortage of marine omega-3s is to increase the scale of aquaculture massively. Marine omega-3s originate in the algae, both phytoplankton and benthic. Filter feeders and gastropod grazers are therefore a very direct and sustainable way of making this available to humans. And despite the criticism of fish farming of carnivorous species, heavily reliant on fishmeal, the reality is that conversion is very efficient relative to farming warm blooded animals, which are also fed supplementary fishmeal. The species

utilised in fishmeal are unlikely to be directly consumed on a scale that would represent good utilisation in the foreseeable future. So aquaculture makes available not only protein but large amounts of marine omega-3s that would otherwise be inaccessible to large numbers of people.

The development of responsible sourcing policies in fisheries (eg Marine Stewardship Council- MSC), aquaculture (Aquaculture Stewardship Council-ASC) and fishmeal (International Fishmeal and Fish Oil Association- IFFO Improvers Programme) will play an important role in ensuring that not only fisheries but also aquaculture develop in a sustainable way.

For fish aquaculture to continue expanding, greater reliance will need to be placed on micro-algal culture as a future source for omega-3 PUFAS for incorporation into fish feeds. This was reviewed by Arnauld Muller-Feuga in *Microalgal Culture* (Blackwell Publishing 2004). He estimated a global shortfall of 10-15 million tonnes of PUFAS by 2020. Much of this may be produced using algae in heterotrophic fermentation, in addition to photosynthetic culture. Clearly aquaculture has a significant part to play in providing a healthy diet for more people.

REFERENCES

- (1) Lands, JW 2008 A critique of paradoxes in current advice on dietary lipids. *Progress in Lipid Research* 47, 77-106.
- (2) Brunner E., Jones P., Friel S. and Bartley M., 2008 Fish, human health and marine ecosystem health: policies in collision. *International Journal of Epidemiology* 2009, 38;93-100.
- (3) Chopin T., Troell M., Reid G.K., Knowler D., Robinson S.M.C., Neori A., Buschmann A.H., Pang S.J. and Fang J. 2010 Integrated Multi-Trophic Aquaculture (IMTA) – a responsible practice providing diversified seafood products while rendering biomitigative services through its extractive components. Abstracts. *Aquaculture Europe* 2010. Porto. Portugal.

clive@bellhammer.myzen.co.uk

Multi-trophic aquaculture in irrigation reservoirs



Mario Pedini graduated from the Faculty of Biological Sciences, at the University of Barcelona and has worked at the FAO from 1973 until his retirement in 2005. He has been Senior Advisor for the Development of Aquaculture at the FAO, and officer of Fisheries and Aquaculture in the World Bank Cooperative Programme. During his professional career at the FAO, he has worked on projects in the field and at headquarters in Rome. It has been responsible for formulating and monitoring field projects in all continents and has held positions as technical secretary on several committees on fisheries and aquaculture, especially the Mediterranean (GFCM) and Latin America (COPESCAL). He was cofounder of the FAO aquaculture newsletter and author / editor of several publications. After retiring in 2005, has worked as a consultant on World Bank projects in India and Madagascar.

The concept of multi-trophic aquaculture involves species being mixed to exploit the various links in the food chain, is not new and has its origins in carp polyculture in China. Today in mariculture, research is conducted into combining intensive fish farming with filtering molluscs and algae in order to reduce at least part of the environmental impact of the intensive farming of fish and, at the same time, obtain economic benefit from the use of the organic and inorganic waste generated. In traditional extensive or semi-intensive polyculture, there is a tendency to look for combinations of species with different feeding habits that optimize protein processing of natural energy and nutrients from the farming ponds.

Although these forms of carp pond polyculture were traditional in China, and are profusely described in the literature and in manuals and slides of the FAO dating back to the decade 1970-80, the country's modernization led to a shift towards intensive farming, with the additional use of artificial feeding, water and energy for aeration of ponds to achieve more production per unit area, but also to involving a greater environmental impact and operating costs due to a higher production.

Since the early 80's in Bangladesh and since the 90's in India, there have been extensive polyculture projects to increase production

in water bodies of the floodplain of rivers or reservoirs used for irrigation in agriculture. These projects were primarily funded by the World Bank, with the participation of the FAO Investment Centre, in most cases for their design and supervision.

These projects have been launched in the Indian states of Orissa, Assam, Madhya Pradesh, Karnataka, Andhra Pradesh and Tamil Nadu, and designs have been improved on as experience is built up and the best material was used to seed the reservoirs. India has tens of thousands of small reservoirs with maximum flooded areas covering between 10 and 1,000 hectares. Some of these reservoirs were built four or five centuries ago to dam up water during the monsoon period for subsequent use in irrigation. There are few reservoirs that hold water throughout the entire year, and they begin to fill up with the monsoon rains from June to July, usually becoming completely dry between December and March.

Production in these reservoirs before these new projects was non-existent or very low, in the order of ten to thirty kilogrammes/ hectare. In some, fishermen used to seed very small young (cheaper), which had a high initial mortality rate, with no time to reach commercially interesting sizes. The new seeding strategies have involved using larger fry of several species of Indian carps in seeding densities that take into account the variation of both the size of the reservoir

when full and when dried up, the growth curves of the species, and the availability of natural food in the reservoir. In Andhra Pradesh, where fry have "stunted" fish of ten months of age whose growth has been delayed on purpose to keep them in pre-rearing at very high power densities and feed very low in protein, have achieved spectacular growth in five months of rearing. Once these fry are reintroduced into an extensive environment, they have a growth rate that is much higher than the fry that are not subject to this process of growth retarding. With combinations of three or four species of Indian carps and some Chinese, productions of over four kilos per hectare have been obtained in initial trials. In cycles of seven to eight months, as opposed to the less than thirty kilogrammes of low value fish obtained before the start of these projects.

The problem with these programmes is to train communities as they only have an experience cycle/year and adjustments in seed density vary from one reservoir to another and depending on whether it is the monsoon season or otherwise. Furthermore, there are also few technicians trained in these new concepts. To this end, research and training programmes have been proposed on hydrology and changes in capacity of the reservoirs that the Indian government and the states should put in place. These techniques have a considerable social potential if one considers the poverty of rural communities in central and southern India, not to mention the poverty of fishermen in particular, and the positive impact on the income of the families concerned.

pedini3@hotmail.com

Integrated farming experience with croaker, variegated scallop, mussel and sea cucumbers



José María Valencia Cruz holds a degree in Biology from the Universidad Complutense de Madrid. In 1991, he joined the research team in aquaculture in the Autonomous Community of the Balearic Islands, now called LIMIA. He has participated in investigations into larval rearing of dentex, rubberlip grunt, croaker and warty venus. He also contributed to studies on catching octopus and lobster with traditional techniques and mapping areas potentially suitable for aquaculture in the Balearic Islands. He currently heads the sub-projects of integrated aquaculture and rearing of common octopus, besides health plans in fisheries and aquaculture and follow-up of the production areas of bivalve molluscs in the Balearic Islands.

One of the advantages of integrated farming systems is an environmental improvement of installations, as other organisms consume the waste produced by the main culture.

The experience with the cages at the Marine Research Laboratory and Aquaculture (Puerto de Andratx, Balearic Islands) complex pursues this goal, apart from evaluating the economic potential of the production obtained thanks to the integrated farming system.

For the purposes of this experience, a bivalve collector system was mounted in the cages, upwind of the mainstream in the port of Andratx, consisting of plastic mesh bags measuring 9 mm filled with 5 mm plastic mesh and an ongrowing net with mussels attached to it. Also, just below the fish rearing cages, a 3 m² fence was mounted of with sea cucumbers, to enable them to be fed with particulate matter (uneaten feed and faeces), which falls from the cages.

In order to confirm that the filter feeders (scallops and mussels), and detritivores (sea cucumbers), feed on waste deriving from the main activity, analyses were conducted on the isotopic flux of carbon and nitrogen. Studies were also made to determine whether there has been an improvement over the living sediment holothurians by

analysis of carbon, nitrogen and phosphorus from sediment samples.

The results obtained are as follows:

- The catching systems collect variegated scallop seed (*Chlamys varia*), flat oyster (*Ostrea edulis*) and other bivalve molluscs that have no commercial interest. In addition, these collectors are used as a refuge for a small shrimp (*Lysmata seticaudata*), which has a certain economic interest as it can be used as bait in angling. Flat oyster was not ongrown because it has a high mortality due to marteiliosis, which is endemic to the Balearic Islands.
- Scallops are in the spawning stage from October to June. It was noted that they do not feed in July and August.
- The presence of *Perkinsus mediterraneus* was detected in variegated scallop and oyster.
- Due to the fact that the collector system is efficient in catching the protected bivalve *Pinna nobilis*, its design is used in a project on this species.
- Variegated scallop catching is highest between October and April.
- The same collectors can be used as

ongrowing devices. Commercial size is achieved after 19 months of immersion, the optimum time for collection being at 22 months. At this point, the number of commercial sized individuals is reduced since new recruits are captured.

- The undersized variegated scallops may gain weight. But however, management must be extremely rigorous because of its ethology. Once cut off, if kept out of the water, they attempt to shift by opening and closing their valves, which makes them dry up. Therefore, they should always be handled in the water while keeping them dry for as short a time as possible. The first tests carried out gave a mortality rate close on 95%. This is because once put into baskets for ongrowing, the individuals swim and insert one of the valves in the mantle of another variegated scallop. At this point, they are unable to break away and the wounds kill them. This problem has been overcome by introducing each individual

int mesh bags, leading to a survival rate of almost 90%.

- The isotopic signature of C and N mainly comes from animal feed surplus used in feeding cages and from particulate organic matter which, in turn, contains the isotopic signature of these surpluses, showing that filtering *M. galloprovincialis* and *C. varia* are an efficient system for reducing the organic load associated with aquaculture cages. Sea cucumbers are less efficient.
- It has not been possible to establish that sea cucumbers reduce the content in nitrogen, phosphorus and carbon in the sediment. The cause is unknown and may be due to several factors: anthropogenic influences, the cages act as sediment traps, sediment movements in the temporal and/or terrigenous contributions due to rain.

jmvalencia@dgpesca.caib.es

Another way to increase the value of waste



José Manuel Cousido Suárez, Abonomar director since 1989, is an entrepreneur and pioneer in finding solutions for waste management in the canning industry. Abonomar has focused its activity on recycling shells, by a process of revaluation. Their products are backed by R&D+i research, aimed at developing new products.

In Galicia intensive mussel farming leads to a significant amount of waste in the form of material from unused floating rafts. This involves ropes and other elements that are now fully recycled. Alongside this, the canning industry also generates waste, the most important being shells from bivalves, primarily mussel, cockle and clam, disposal of which is a problem, but if appropriately processed products become commercially valuable.

In 1989, the company Abonomar, based on the Isle of Arosa (Pontevedra), started to work as the first Galician industry to recycle seashells. This business initiative arose with the objective of providing solutions to the problem of waste generated by the canning industry.

In general terms, one can say that this economically feasible industrial alternative was applied to treating waste generated by the revaluation technique known as the three “R’s”: Reduce, Reuse and Recycle. Through this process, waste from aquaculture and the processing industry is converted into ecological products that are environmentally friendly.

Abonomar is a pioneer in the recycling of seashells and has a corporate commitment to the industries operating responsibly with the waste that they generate, offering them legal coverage in the management and, as a

result of this, tipping has been curbed.

To date, we have conducted several R&D+i research projects on possible applications of mussel shells. In this field, we have obtained several patents, including a bed for livestock stabling, substrata for gardens, golf courses and football pitches, and substrata for beaches and farm parks.

We are currently collaborating with research teams from several universities to carry out innovative projects as well as with private companies that develop products involving mussel shells.

We have developed mineral supplements for the poultry industry in general using shells from oyster and from other bivalves. Finally, it should be noted that waste from work on the floating beds is transformed, in collaboration with several Galician livestock cooperatives, to be used as organic matter in nutrients for grasslands, with very good results.

central@abonomar.com

Fish and seaweed



Fernando Nieto Cortijo was technical director of the four farms in freshwater salmonid mariculture, from 1977 to 1996. These farms annually produce 200,000 juvenile salmon (smolt) for ongrowing in salt water and in floating cages in the Ria of Ortigueira (A Coruña) and, occasionally, in the Ria of Muros (A Coruña). In addition to that, 2,000 tonnes per year of rainbow trout and 2,000,000 tonnes of trout and salmon eggs were reared to self-supply its own production and to supply third parties. Currently, and since 1996, he is fisheries inspector for the Regional Department of the Rural and Maritime Environment of the Regional Government of Galicia.

Mariculture began developing salmon farming in salt water in 1976, so that when I joined in 1977, I took part in the design of the floating cage, currently operational at those installations. The model was constructed from galvanized steel with plastic floats moored to the bottom of the Ria of Ortigueira. The first Spanish experience of salmon farming was carried out with these artifacts.

The species worked with initially was Atlantic salmon (*Salmo salar*), but the characteristics of the Ria of Ortigueira - high-speed flow, shallow draft and low-tide water depth in the mooring channels, generated a range of water temperatures that made salmon farming impracticable.

Due to stress, populations proved to be vulnerable, with high mortality rates in the commercial sized individuals. The decision was to work with Coho salmon (*Oncorhynchus kisutch*), a Pacific variety.

OTHER SPECIES

Farming salmon began with the incubation of fertilized eggs and, after nine months of ongrowing in fresh water, the smolts were transferred to Sismundi, Cariño. After acclimatization in tanks with salt water, while adding salt to food, they were placed in cages submerged in the river for ongrowing until reaching commercial size, which was set at about 1,250 g. There were around 500 tonnes a year of this salmon. Rainbow

trout array (the “steel head” variety) was also farmed, in salt water, giving excellent results. 300 tonnes per year of sea salmon trout weighing 1,500 g were produced.

The first experience with turbot was conducted bottom moored cages, whose design was similar to the floating version, but with floats and netting on all six sides. This was another innovative experience in Spain, which proved successful. Turbot would ongrow in contact with a sandy bottom and, when reaching commercial size, they were placed in floating cages. We obtained 200 tonnes per year of turbot.

As far as molluscs are concerned, they were reared in an intertidal park in the Ria of Ortigueira and on floating beds in the Ria of Muros. Work involved Japanese oyster, grooved carpet shell and carpet shell.

This is the technical background and the species that have been farmed in mariculture. An experience was conducted using the cages involving multi-trophic cultures with turbot and the macroalgae *Saccharina latissima*. In fact, in the submerged cages what might be called a “reef effect” occurred, gradually and, in a natural way, forming colonies of algae, invertebrates and fish that live off the remains of feed. This suggests the possibility that different links in the food chain within a single ecosystem are compatible, due to the relationships established between species.

fernico@telefonica.net



INSTITUTO ESPAÑOL
DE OCEANOGRAFÍA



UNIVERSIDADE DA CORUÑA

galicia



CIMA
CENTRO DE
INVESTIGACIÓNS
MARÍNEAS



JACUMAR
JUNTA NACIONAL
ASEORA DE CULTIVOS MARINOS



XUNTA
DE GALICIA