



**HAL**  
open science

## Energy-Efficient Cooperative Techniques for Infrastructure-to-Vehicle Communications

Tuan-Duc Nguyen, Olivier Berder, Olivier Sentieys

► **To cite this version:**

Tuan-Duc Nguyen, Olivier Berder, Olivier Sentieys. Energy-Efficient Cooperative Techniques for Infrastructure-to-Vehicle Communications. *IEEE Transactions on Intelligent Transportation Systems*, 2011, 12 (3), pp.659 -668. 10.1109/TITS.2011.2118754 . hal-00741553

**HAL Id: hal-00741553**

**<https://hal.science/hal-00741553v1>**

Submitted on 28 Oct 2012

**HAL** is a multi-disciplinary open access archive for the deposit and dissemination of scientific research documents, whether they are published or not. The documents may come from teaching and research institutions in France or abroad, or from public or private research centers.

L'archive ouverte pluridisciplinaire **HAL**, est destinée au dépôt et à la diffusion de documents scientifiques de niveau recherche, publiés ou non, émanant des établissements d'enseignement et de recherche français ou étrangers, des laboratoires publics ou privés.

# Energy efficient cooperative techniques for infrastructure to vehicle communications

Tuan-Duc Nguyen<sup>\*†</sup>, Olivier Berder<sup>†</sup>, Olivier Sentieys<sup>†</sup>

<sup>\*</sup>International University of Vietnam National University, Vietnam

Email: ntduc@hcmiu.edu.vn

<sup>†</sup>IRISA - University of Rennes 1, France

Email: Firstname.Lastname@irisa.fr

**Abstract**—In wireless distributed networks, cooperative relay and cooperative Multi-Input Multi-Output (MIMO) techniques can be used to exploit the spatial and temporal diversity gain in order to increase the performance or reduce the transmission energy consumption. The energy efficiency of cooperative MIMO and relay techniques is then very useful for the Infrastructure to Vehicle (I2V) and Infrastructure to Infrastructure (I2I) communications in Intelligent Transport Systems (ITS) networks where the energy consumption of wireless nodes embedded on road infrastructure is constrained. In this paper, applications of cooperation between nodes to ITS networks are proposed and the performance and the energy consumption of cooperative relay and cooperative MIMO are investigated in comparison with the traditional multi-hop technique. The comparison between these cooperative techniques helps us to choose the optimal cooperative strategy in terms of energy consumption for energy constrained road infrastructure networks in ITS applications.

## I. INTRODUCTION

In future Intelligent Transport Systems (ITS), information and communication from the road infrastructure to vehicle (I2V) will play a key role in driving assistance, floating car data, and traffic management in order to make the road safer and more intelligent. The communications are supported by wireless nodes integrated in road signs (or traffic infrastructure along the road) and vehicles. While wireless nodes embedded in vehicles can take profit from their battery or can be regularly recharged, each road sign wireless node is usually powered by a small battery that may not be rechargeable or renewable for long term (or powered by a low power solar battery). Even if such networks are mainly concentrated in cities (but new applications appear for rural junctions too), many of the nodes are not necessarily connected to electrical power supply, due to the civil engineering cost. The energy consumption of road infrastructure wireless nodes is consequently one

of the important constraints in order to increase the reliability and the lifetime of this network.

As the transmission power increases quickly as a  $K$  power function of the transmission distance (with typical path loss factor  $2 < K < 6$ ), the transmission energy consumption plays an important role for medium and long range transmission and represents the dominant part of the total energy consumption. In some ITS applications, energy efficient transmission techniques are very important for the communication from an energy constrained device like road infrastructure to a vehicle (I2V) or to another energy constrained device (I2I). In traditional approach, multi-hop transmission technique is used to reduce the transmission energy consumption by dividing the long transmission channel into multiple short transmissions.

The cooperative relay technique can exploit the spatial and temporal diversity gain in order to reduce the path loss effect in wireless channels. The result is that the system performance is improved or less energy is needed for data transmission. Relay techniques are recognized as a simple and energy efficient way to extend the transmission range due to their simplicity and their performance for wireless transmissions over fading channels [1], [2] and [3]. They have been recently studied in the context of Vehicle-to-Vehicle communications in [4].

Beside the relay technique, some individual sensor nodes can cooperate at the transmission and the reception in order to deploy a cooperative Multi-Input Multi-Output (MIMO) transmission scheme [5], [6], [7]. Classical MIMO transmission is investigated for V2V transmissions and should be proposed in the future 802.11p standard. Unfortunately the nodes embedded in the road signs can not have more than one antenna because of the limitations in space, cost and energy consumption. Therefore classical MIMO can not be applied to I2I and I2V communications. On the other hand, cooperative MIMO can exploit the diversity gain of space-time coding technique to increase the system

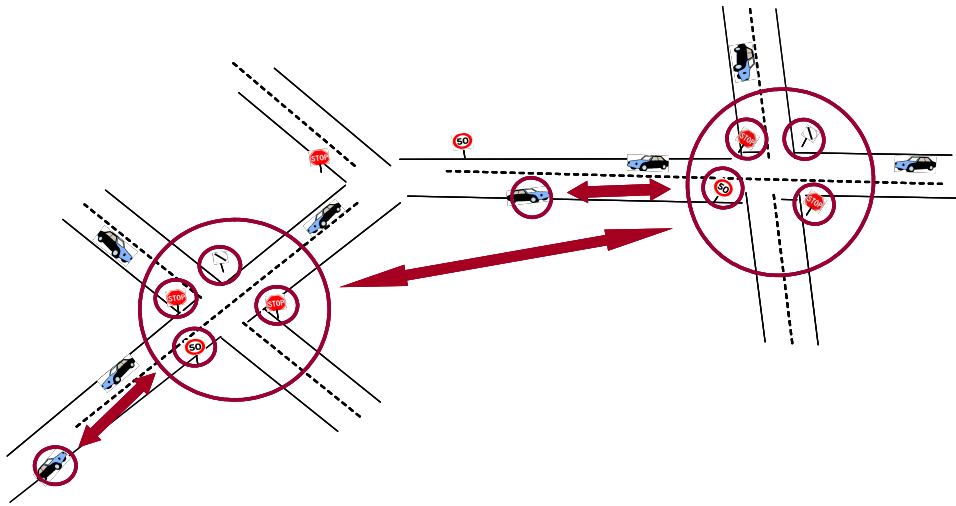

Fig. 1. Infrastructure-to-Infrastructure and Infrastructure-to-Vehicle wireless communications in the CAPTIV, Intelligent Transport System Project.

performance or to reduce the energy consumption. In [8] [9], it has been shown that cooperative MISO and MIMO systems are more energy-efficient than Single-Input Single-Output (SISO) and traditional multi-hop SISO systems for medium and long range transmission in wireless distributed sensor networks. Other recent works on MIMO STBC transmission in ITS applications can be found in [10], [11]. On the other hand, cooperation between nodes can also help to extend the transmission range (with the same output power of one wireless node), thus increasing the communication distance between two nodes or two groups of nodes.

In this paper, these cooperative techniques are adapted to ITS applications and characterized for I2V and I2I cooperative transmissions. The context of the study is the CAPTIV project (Cooperative strategies for low Power wireless Transmissions between Infrastructure and Vehicles) [12], where the network composed of wireless nodes at a junction has to give to the arriving vehicles short term information for driving assistance and long term information for traffic management. It is shown that the cooperative MIMO and relay techniques are better than the Single-Input Single-Output (SISO) and SISO multi-hop technique in terms of performance and energy consumption. Both techniques are interesting in the energy constrained ITS applications and the advantages of each technique depend on the particular network structure or on the application. Based on a reference model, energy consumption calculations help us to choose the optimal cooperative strategy in terms of energy consumption for CAPTIV, with respect to the transmission distances between two junctions or between a junction and a vehicle.

The rest of the paper is organized as follows. The principle of cooperative strategies for the energy consumption optimization are presented in Section II. In Section III, the energy calculation model is proposed and simulation results on the energy consumption comparison of cooperative techniques in CAPTIV are presented in Section IV. Finally, conclusions and discussion are given in Section V.

## II. COOPERATIVE TRANSMISSIONS AND CAPTIV CONTEXT

A scientific coordination group devoted to Intelligent Transportation Systems, called GIS ITS Bretagne, has been set up in the Brittany region of France, to investigate this research area. One of its projects, CAPTIV, aims at using existing infrastructure, i.e. road signs but also every infrastructure along the road, to transmit information inside a wireless network including equipped vehicles, as illustrated by Fig.1. The first applications offered by CAPTIV are road signs anticipated displays (including dynamic situations as temporary works on the road) and arriving vehicle indications (in order to help a driver at a stop to start or not on the main road in case of smog, heavy rain or snow, for example). In such a network, every kind of information can be transmitted, leading then to more advanced applications which integrate live data and feedback from a number of other sources, such as parking guidance and information systems, weather information, and so on.

In the CAPTIV system, information is transmitted, thanks to vehicles and existing infrastructure, within a network whose typical size is metropolitan. The communications can occur from road infrastructure to vehicle

(I2V), road infrastructure to road infrastructure (I2I), vehicle to road infrastructure (V2I) or a vehicle to vehicle (V2V). The energy constraint for road sign infrastructure is very important due to the fact that batteries in traffic road signs can not be replaced for a long time.

### A. Relay and Cooperative MIMO Techniques

The traditional model for relay diversity technique with one relay node shown in Fig. 2, consists in a source node S, a destination node D and a relay node R. The relay transmission from S to D can be performed by a two-time slot transmission. In the first time slot, signals are transmitted by the source S to the destination node D and the relay node R at the same time. In the second time slot, the relay node retransmits the information previously received. At node D, the receiver combines received signals by using a diversity combination technique (MRC, EGC...) before symbol detection.

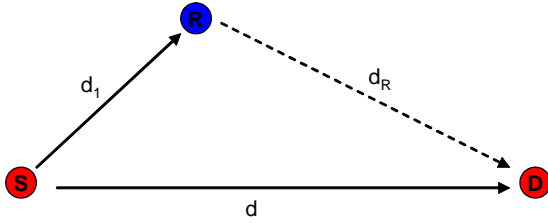

Fig. 2. Three terminal relay diversity scheme.

In relay cooperative networks, the received signal comes from different independent fading channels, so that the probability of deep fading is minimized. This diversity gain helps to decrease the error rate, or to decrease the transmission power for the same required error rate. Relay techniques can be classified according to their forwarding strategy. There are three main methods for the relay node to transmit the received frame to the destination node: Amplify and Forward, Decode and Forward, and Re-encode and Forward.

Multi-Input Multi-Output (MIMO) technique can exploit the diversity gain of space-time coding technique in order to increase the system performance or to reduce the transmission consumption for the same Bit Error Ratio (BER) requirement. The principle of cooperative MIMO transmission using space-time block codes (STBC) was presented in [8]. As illustrated by Fig. 3, the cooperative MIMO transmission (with  $N$  cooperative transmission and  $M$  cooperative reception nodes) from source node S to destination node D over a transmission distance  $d$  is composed of three phases: Local data exchange, cooperative MIMO transmission and cooperative reception.

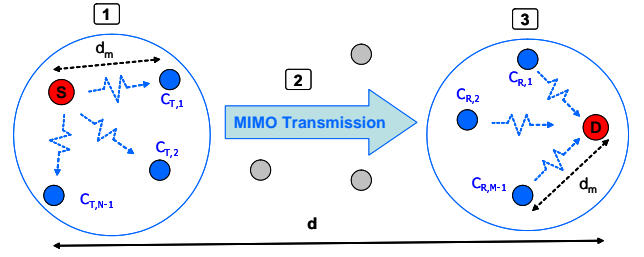

Fig. 3. Cooperative MIMO transmission scheme from S to D with  $N$  cooperative transmission nodes ( $S, C_{T,1}, C_{T,2}, \dots, C_{T,N-1}$ ) and  $M$  cooperative reception nodes ( $D, C_{R,1}, C_{R,2}, \dots, C_{R,M-1}$ ).

In the local data exchange at the transmission side, the source node S must cooperate with its neighbors and exchange its data in order to perform a MIMO transmission in the next phase. Node S can broadcast the transmission bits to the other  $N - 1$  cooperative transmission nodes. The distance between cooperating nodes  $d_m$  is usually much smaller than the transmission distance  $d$ . In cooperative MIMO transmission phase, after  $N - 1$  neighbor nodes receive the data from source node S,  $N$  cooperative transmission nodes will modulate and encode their received bits to the QPSK STBC symbols and then transmit simultaneously to the destination node (or multi-destination nodes) like a traditional MIMO systems (each cooperative node plays role of one antenna of the MIMO system). In finally in the cooperative reception phase at the reception side, cooperative neighbor nodes of destination node D receive the MIMO modulated symbols, then sequentially retransmit them to the destination node D for joint MIMO signals combination and data decoding. In a cooperative MIMO system, the decoder at destination node D requires the analog value of received signals at all cooperative nodes for the space time combination. Therefore, each cooperative node must transmit their received value through a wireless channel to the destination node D. Three cooperative reception technique: Quantization, Combine-and-Forward or Forward-and-Combine can be used for this retransmission procedure [13].

### B. Performance comparison of cooperative techniques

As the cooperative relay and cooperative MIMO technique can exploit the diversity gain to increase the performance, the performance of both techniques is much better than the SISO technique and the needed Signal-to-Noise Ratio (SNR) is smaller for the same error rate requirement. Fig. 4 represents the Frame Error Rate (FER) performance comparison of the relay (Decode-and-Forward and Amplify-and-Forward techniques) and the cooperative MISO techniques for two transmit nodes

with the traditional SISO technique.

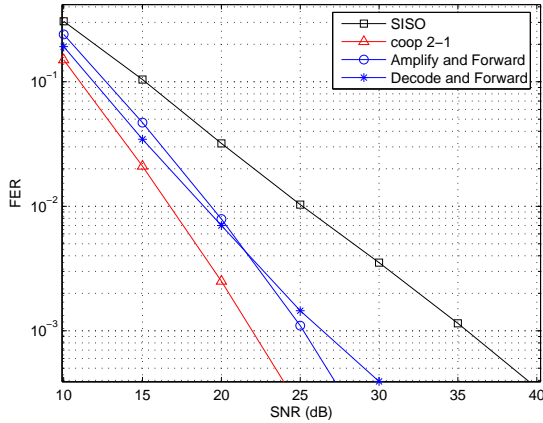

Fig. 4. FER of relay technique vs. cooperative MISO technique with two transmission nodes, non-coded QPSK modulation over a Rayleigh channel, 120 bits/frame, source-relay distance  $d_1 = d/3$ , and power path-loss factor  $K=2$ .

As needed SNRs of the cooperative MISO and relay techniques are smaller than the SISO technique, the two cooperative techniques can help to reduce the transmission energy consumption for the same transmission reliability in an energy constrained traffic-signs wireless network. This energy efficiency of cooperative MIMO and relay techniques is very useful for a typical medium to long distance transmission in ITS application where the transmission energy consumption dominates the total consumption of a wireless node.

The nature of STBC [14][15] considers that the signals from different transmit antennas must be received synchronously at each cooperative node to perform the orthogonal combination. Furthermore, the clock of each wireless node can be drifted during transmission times and the transmission delay can vary for each MIMO channel. Consequently, it is impossible to have a perfectly synchronized transmission in distributed wireless nodes, leading to a unsynchronized received signal at the reception node. The effect of the transmission synchronization error is the superposition of the signal pulses from each node, shifted by the corresponding time delay, at the receiver. After the synchronization and the signal sampling process, Inter Symbol Interference (ISI) between the unsynchronized sequences appears and the space-time sequences from the different nodes are no longer orthogonal. The orthogonal combination of space time codes can not be performed, which leads to the amplitude decrease of the desired signal and generates more interferences in final estimated symbols [16].

The effect of transmission synchronization in the

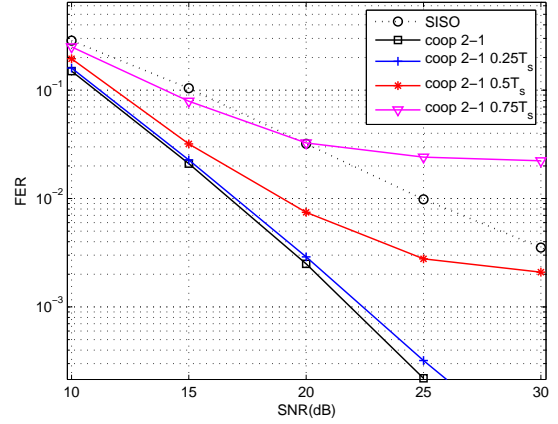

Fig. 5. Effect of the transmission synchronization error on the performance of cooperative MISO systems with two transmit nodes  $N = 2$ , Alamouti STBC over a Rayleigh fading channel.

performance of cooperative MIMO technique for the case of two transmit node is presented in Fig. 5. The performance degradation increases with the transmission synchronization error range. The cooperative MIMO system is rather tolerant for small range of transmission synchronization error and the degradation is negligible for synchronization error range as small as  $0.25T_s$  (and small for error range as small as  $0.5T_s$ ). For small transmission synchronization error ranges, the performance degradation is small enough to keep the energy efficiency advantage of cooperative MIMO system over SISO and multi-hop SISO techniques. However, the performance degradation is significant for transmission synchronization errors as large as  $0.75T_s$ . In this case, a more complex distributed space time code or a efficient space-time combination technique can be used in order to retain the performance of cooperative MIMO in the presence of transmission synchronization error.

### C. Cooperative Transmission Schemes in CAPTIV project

In plenty of communication scenarios in ITS, the transmission between the infrastructure and the vehicles are usually from a medium to long distance and a direct transmission, if possible, would need too much transmission energy. A traditional multi-hop routing technique can be used for such transmissions but it is not efficient enough in terms of energy consumption in many cases. By exploiting the diversity transmission to reduce the transmission energy consumption, relay and cooperative MIMO techniques are the better strategies in terms of energy efficiency.

Considering that the circle and the rectangle stand respectively for the road sign and the vehicle in the transport system, some cooperative transmission strategies, illustrated in the following figures, have been proposed for energy efficiency transmissions in CAPTIV.

1) *SISO multi-hop transmission*: The most simple cooperation scheme is the multi-hop SISO transmission, as shown by Fig. 6. Instead of the transmission over a long distance from source node S to the destination node D, a message from a road sign (source node S) at a junction can be transmitted through multiple road signs (cooperation nodes) to a vehicle (destination node D). Multi-hop transmission can save significantly the transmission energy consumption with the cost of more circuit energy consumption.

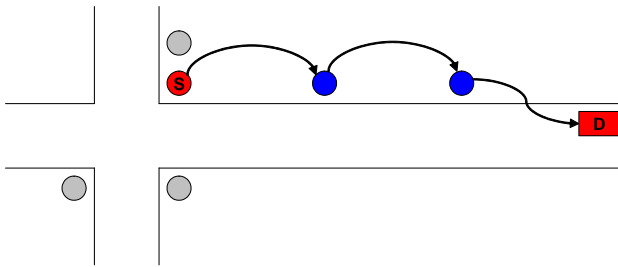

Fig. 6. Multi-hop SISO transmission between infrastructure and vehicle

2) *Relay transmission*: In Fig.7, a message from the road sign can be transmitted to the vehicle (destination node D) and another road sign (relay node R). Then, the message is relayed from this relay road sign to the vehicle for signal combination. Transmission diversity gain of relay technique helps to decrease the transmission power for the same error rate requirement, so that reduce the transmission energy consumption. This technique is more energy efficient than multi-hop SISO for medium range transmission.

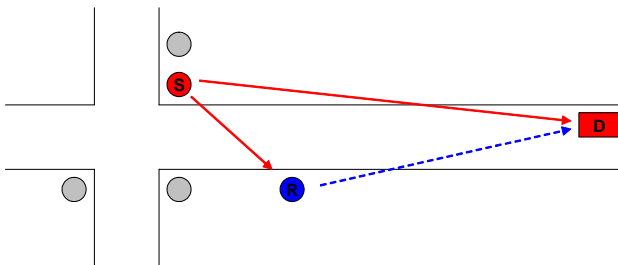

Fig. 7. Relay transmission between infrastructure and vehicle

3) *Cooperative MIMO transmission*: Cooperative MIMO technique is an energy efficient cooperative technique for medium and long range transmission [9].

Cooperative MIMO technique exploits the diversity gain of the MIMO space-time coding technique in distributed wireless networks in order to reduce the transmission energy consumption. Depending on the system topology (the available nodes) and the transmission distance, the optimal selection of transmit and receive nodes number can be chosen in order to minimize the total energy consumption.

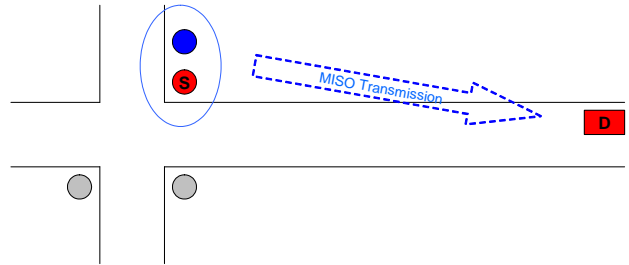

Fig. 8. Cooperative MISO transmission between infrastructure and vehicle

As illustrated on Fig. 8, a road sign node S can cooperate with its neighbor road signs to employ a cooperative MISO (Multiple Input Single Output) technique to transmit a message to the vehicle (destination node D).

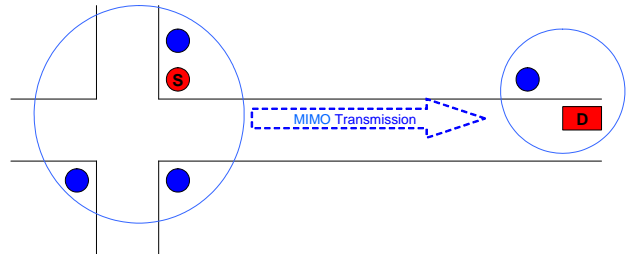

Fig. 9. Cooperative MIMO transmission between infrastructure and vehicle

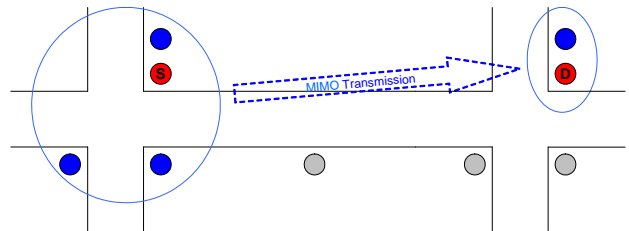

Fig. 10. Cooperative MIMO transmission between infrastructure and infrastructure

As shown by Fig. 9, the road sign node S and the vehicle node D can cooperate with their respective neighbor road signs to employ a cooperative MIMO transmission over a long distance. As the vehicles do not have the surface and energy consumption constraints,

multiple antennas can be easily integrated in a vehicle to deploy the cooperative MIMO schemes without the need of the cooperative reception phase [9].

Another example of cooperative MIMO transmission in CAPTIV is shown in Fig. 10, where the road sign node S can cooperate with other road signs in one junction to transmit the message by using a cooperative MIMO technique to the cooperative reception road signs in the other junction.

4) *Multi-hop cooperative MIMO transmission*: For a long distance communication, the cooperative MIMO technique with the number of transmit and receive nodes greater than 2 has energy consumption advantages [9], but this scenario can not be always employed because of the lack of available nodes at the junctions. In this condition, a multi-hop technique using cooperative MIMO for each transmission hop is a suitable solution. As an example, for a communication between two crossroads with a distance greater than 1km in Fig. 11, two road signs in the middle of the transmission line can be employed (and cooperate together) to perform a multi-hop cooperative MIMO transmission.

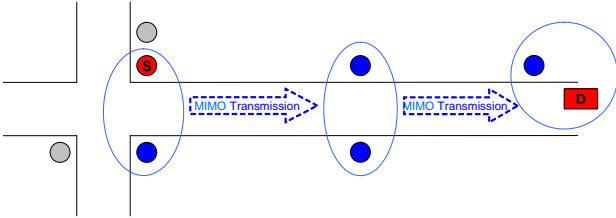

Fig. 11. Multi-hop cooperative MIMO transmission between infrastructure and vehicle

### III. ENERGY EFFICIENCY OF COOPERATIVE STRATEGIES

#### A. Energy consumption model

For a traditional MIMO system (non-cooperative MIMO system) with  $N$  transmit and  $M$  receive antennas ( $N$  transmit antennas and  $M$  receive antennas are integrated in one transmitter and one receiver), the typical RF system block of transmitters and receivers is shown in Fig. 12. The total power consumption of a typical MIMO system consists of two components: the transmission power  $P_{pa}$  of the power amplifier and the circuit power  $P_c$  of all RF circuit blocks.

$P_{pa}$  depends on the output transmission power  $P_{out}$ . If the channel is square law path loss (power loss factor  $K = 2$ ), the needed transmission power can be calculated as

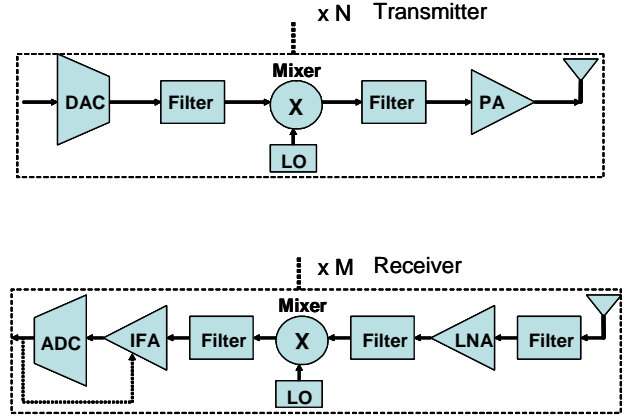

Fig. 12. Transmitter and receiver blocks with  $N$  transmit and  $M$  receive antennas.

$$P_{out}(d) = \bar{E}_b R_b \times \frac{(4\pi d)^2}{G_t G_r \lambda^2} M_l N_f \quad (1)$$

where  $\bar{E}_b$  is the mean required energy per bit for ensuring a given error rate requirement,  $R_b$  is the bit rate,  $d$  is the transmission distance.  $G_t$  and  $G_r$  are the transmission and reception antenna gain,  $\lambda$  is the carrier wave length,  $M_l$  is the link margin,  $N_f$  is the receiver noise figure defined as  $N_f = M_n/N_0$  with  $N_0$  is the single-side thermal noise Power Spectral Density (PSD) and  $M_n$  is the PSD of the total effective noise at receiver input.

Depending on the number of transmit and receive antennas ( $N$  and  $M$ ), and the Power Spectral Density (PSD) of thermal noise  $N_0$ , the  $\bar{E}_b$  can be calculated based on  $SNR$  value given by Tab. I for error rate requirement  $FER = 10^{-3}$  and the performance result in Fig. 4.

$SNR$	$N = 1$	$N = 2$	$N = 3$	$N = 4$
$M = 1$	35.2 dB	22 dB	17.7 dB	15.8 dB
$M = 2$	19.5 dB	12.7 dB	10.4 dB	9.2 dB
$M = 3$	12.5 dB	8.8 dB	7.5 dB	6.7 dB
$M = 4$	9.7 dB	6.5 dB	5.4 dB	5 dB

TABLE I  
 $SNR$  REQUIREMENT OF COOPERATIVE MIMO TECHNIQUE FOR  
 $FER = 10^{-3}$  REQUIREMENT, RAYLEIGH FADING CHANNEL

The power consumption  $P_{pa}$  can be approximated as

$$P_{pa} = (1 + \alpha)P_{out} \quad (2)$$

where  $\alpha = \frac{\xi}{\eta} - 1$  with  $\eta$  the drain efficiency of the RF power amplifier and  $\xi$  the Peak-to-Average Ratio (PAR)

which depends on the modulation scheme and the associated constellation size. Indeed, the power consumption of the amplifier is always higher than the effective output power.

The total circuit power consumption of  $N$  transmit and  $M$  receive antennas is given by

$$P_c \approx N(P_{DAC} + P_{mix} + P_{filt} + P_{syn}) + M(P_{LNA} + P_{mix} + P_{IFA} + P_{filr} + P_{ADC} + P_{syn}) \quad (3)$$

where  $P_{DAC}$ ,  $P_{mix}$ ,  $P_{LNA}$ ,  $P_{IFA}$ ,  $P_{filt}$ ,  $P_{filr}$ ,  $P_{ADC}$ ,  $P_{syn}$  stand respectively for the power consumption values of the digital-to-analog converter, the mixer, the low noise amplifier, the intermediate frequency amplifier, the active filter at the transmitter and receiver, the analog-to-digital converter and the frequency synthesizer. The power consumption of signal processing blocks in transmitter and receiver is typically much smaller than the consumption of RF blocks. It is considered omitted in this estimation for the simplicity.

The energy consumption of the traditional MIMO system  $E_{MIMO}$  can be obtained as

$$E_{MIMO} = (P_{pa} + P_c) \frac{N_b}{R_b} \quad (4)$$

The energy consumption of the SISO technique or one hop of SISO technique is the case that  $N = M = 1$ . The energy consumption of one transmission phase (from  $S$  node to  $R$  node and from  $R$  node to  $D$  node) of the relay technique can be calculated like in the SISO technique case.

For a cooperative MIMO system with  $N$  transmit and  $M$  receive nodes, there are three communication phases: data exchange, MIMO transmission and cooperative reception phases. The energy consumption of the MIMO transmission phase can be calculated like the non-cooperative MIMO case. The total energy consumption must include the energy consumption of cooperative data exchanges and cooperative reception phases. The extra cooperative energy consumption at the transmission side  $E_{coopT_x}$  and at the reception side  $E_{coopR_x}$  can be calculated based on the non-cooperative energy consumption model [9].

The total energy consumption of a cooperative MIMO system with  $N$  transmit and  $M$  receive nodes is

$$E_{total} = E_{coopT_x} + E_{MIMO} + E_{coopR_x} \quad (5)$$

For the case of cooperative MISO transmission ( $M = 1$ ), there are just two first communication phase which means the energy consumption of reception phase  $E_{coopR_x}$  is zero.

$f_c = 2.5$ GHz	$\eta = 0.35$
$G_t G_r = 5$ dBi	$\sigma^2 = \frac{N_0}{2} = -174$ dBm/Hz
$B = 10$ KHz	$\beta = 1$
$P_{mix} = 30.3$ mW	$P_{syn} = 50$ mW
$\bar{P}_b = 10^{-3}$	$T_s = \frac{1}{B}$
$P_{filt} = P_{filr} = 2.5$ mW	$P_{LNA} = 20$ mW
$N_f = 10$ dB	$M_L = 40$ dB

TABLE II  
SYSTEM PARAMETERS FOR THE ENERGY CONSUMPTION EVALUATION.

### B. Energy Consumption Comparison

For energy consumption estimation, evaluation and comparison purposes, the reference energy model in [17] with the system parameters in Table II is used in this paper. More details on the energy consumption calculation using this reference model can be consulted in [9]. The following figures represent the total energy consumption to transmit  $10^7$  bits with the error rate requirement  $FER = 10^{-3}$  from a source node  $S$  to a destination node  $D$  separated by a distance  $d$  (over a Rayleigh fading channel). The local distance between cooperative nodes in cooperative MIMO techniques is  $d_m = 5m$  and the source-relay distance in relay techniques is  $d_1 = d/3$ .

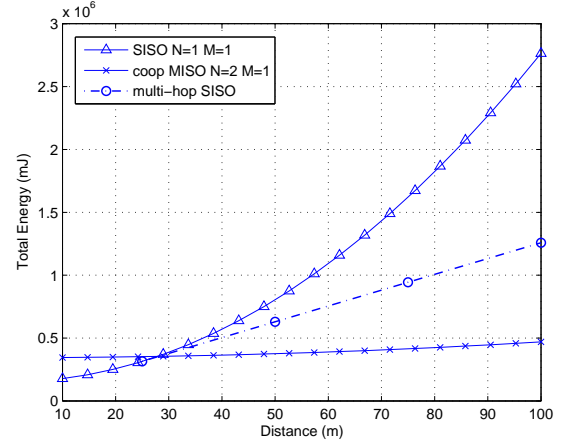

Fig. 13. Energy Consumption of SISO vs. cooperative MISO technique with two transmission nodes, power path-loss factor  $K = 2$ ,  $FER = 10^{-3}$ , Rayleigh fading channel.

1) *Multi hop SISO vs. cooperative MISO Techniques:* The energy consumption comparison between multi-hop SISO and the cooperative MISO is presented on Fig. 13 with the optimal hop distance  $d_{hop} = 25m$ . At the transmission distance  $d = 100m$  (4 hops), the multi-hop technique can save 53% of the total energy consumption of the SISO system.

Multi-hop technique is more efficient than SISO transmission. However, the multi-hop SISO system is 69%



less energy-efficient than the cooperative 2-1 MISO system. At distance  $d = 100\text{m}$ , 85% energy is saved by using 2-1 cooperative MISO strategy instead of SISO. One should note that the total energy consumption is the consumption of all nodes, not only one source node. 69% or 85% is the total energy saving for the whole network by using cooperative techniques. The transmission energy consumption (which is always greater than reception energy consumption for long distance) is shared by all cooperative transmission nodes. Moreover, as the multi-hop system needs four hops for signal transmission to the destination node, the transmission delay of the multi-hop technique is much more than the cooperative MISO technique which cost typically two phases of transmission.

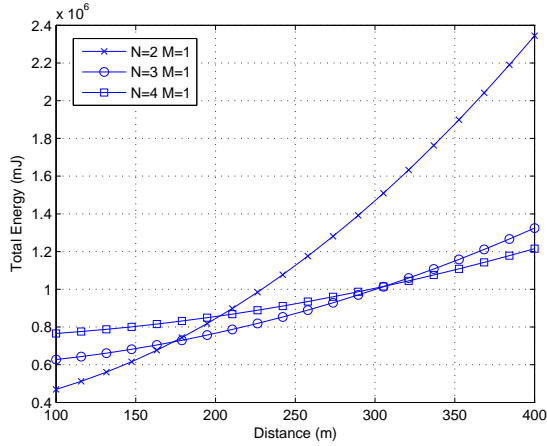

Fig. 14. Energy Consumption of cooperative MISO technique with two, three and four transmission nodes, power path-loss factor  $K = 2$ ,  $FER = 10^{-3}$ , Rayleigh fading channel.

As the performance gain increases with the number of cooperative transmission nodes in cooperative MIMO techniques, the cooperative MISO 3-1 or MISO 4-1 is more efficient than the cooperative MISO 2-1 or MISO 3-1 at  $d = 180\text{m}$  or  $d = 300\text{m}$  respectively as shown in Fig. 14.

If all the RF parameters and the transmission distance are fixed, the transmission energy consumption depends on the required energy per bit  $E_b$  and the power path-loss factor of the channel (as shown in Eq. 1). If the required error rate  $FER$  increases (less reliable transmission), the required SNR and transmission energy consumption will decrease, reducing the energy efficiency advantage of the cooperative MIMO over SISO and SISO multi-hop techniques. Otherwise, if the path-loss factor  $K$  increases (e.g. in a urban environment), the transmission energy consumption increases quickly (as a power function of the path-loss factor  $K$ ). As cooperative MIMO

technique helps to reduce efficiently the transmission energy, the advantage of cooperation increases. As far as the frequency band is concerned, if the frequency  $f_c = 5.8\text{GHz}$  (which was elected by the European Union for ITS applications and is used in Delicate Short Range Communication technology) is considered instead of a reference model frequency  $2.5\text{GHz}$  used in this paper, the transmission energy consumption increases  $(\frac{5.8}{2.5})^K$  times, and the cooperative MIMO technique will probably be more efficient.

Since the nodes are physically separated in a cooperative MIMO system, their different respective clocks lead to de-synchronized transmission and reception. That generates Inter-Symbol Interference (ISI), decreases the desired signal amplitude at the receiver and makes it more difficult to estimate the Channel State Information (CSI). At the reception side, each cooperative node has to forward its received signal through the wireless channel to the destination node for signal combination, which leads to additional noise in the final received signal. The effect of synchronization error at the transmission side and this additive noise at the cooperative reception side lead to some performance degradations of cooperative MIMO system [13]. The transmission energy needs to be increased for the same error rate requirement, which will lead to an increase in the transmission energy and the total energy consumption.

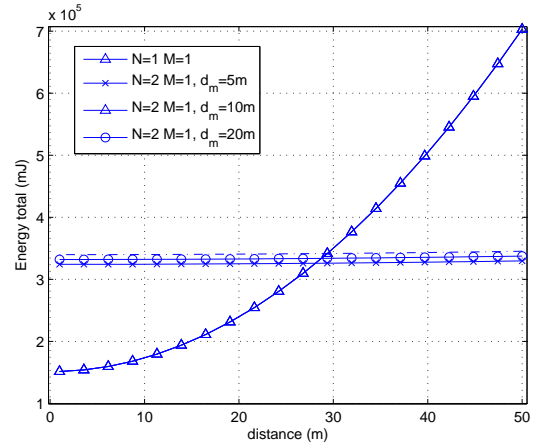

Fig. 15. Energy consumption of the cooperative MISO 2 – 1 with different cooperative transmission distances  $d_m = 5, 10$  and  $20\text{m}$ ,  $FER = 10^{-3}$  requirement, Rayleigh block fading channel with power path-loss factor  $K = 2$ .

The energy consumption of cooperative phase (which depends on the cooperative distance  $d_m$ ) is much smaller than the consumption of the MIMO transmission phase for a long distance transmission (because  $d \gg d_m$ ). Therefore, the variation of the cooperative transmission

distance  $d_m$  affects slightly the total energy consumption of the cooperative MIMO system. Fig. 15 shows the energy consumption of the cooperative MISO systems with different cooperative transmission distance  $d_m = 5, 10$  and  $20m$ .

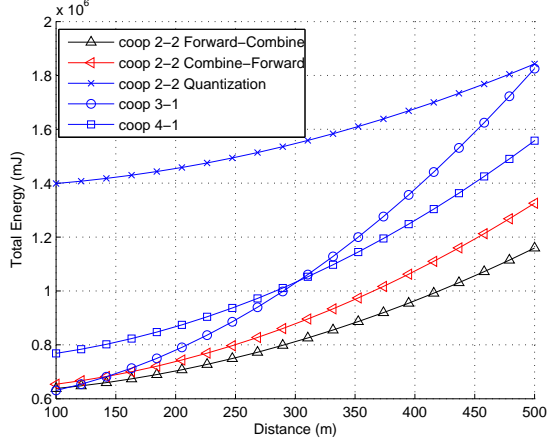

Fig. 16. Total energy consumption of cooperative MIMO with different reception techniques vs. cooperative MISO,  $\Delta T_{syn} = 0.25T_s$ ,  $FER = 10^{-3}$  requirement, Rayleigh fading channel with power path-loss factor  $K = 2$ .

2) *Cooperative MIMO vs. Cooperative MISO Techniques*: Fig. 16 shows the energy consumption comparison between the cooperative MIMO system with two receive nodes and the cooperative MISO systems 3-1 and 4-1. The Forward-and-Combine, Combine-and-Forward cooperative reception (with the amplification factor  $K_c = \sqrt{4}$ ) [13] and Quantization reception are used in the cooperative reception phase of cooperative MIMO technique and the transmission synchronization error range is consider as  $\Delta T_s = 0.25T_s$ .

The energy consumption of the cooperative MIMO 2-2 using Forward-and-Combine cooperative reception technique is always smaller than the cooperative MISO 4-1 consumption, and smaller than cooperative MISO 3-1 consumption for distances  $d > 130m$ . At  $d = 500m$ , 25% energy is saved by using the cooperative MIMO 2-2 technique instead of the cooperative MISO 4-1 technique.

For each range of transmission distance  $d$ , based on the energy calculation result, we can find the best  $N - M$  antenna selection strategy of the cooperative MIMO technique in term of the energy consumption, as shown in Fig. 17. One should note that given the transmission distance and other parameters such as the quality of service (eg. FER, the propagation channel), the global energy consumption must be calculated for every possible  $N - M$  configuration of cooperative MIMO by

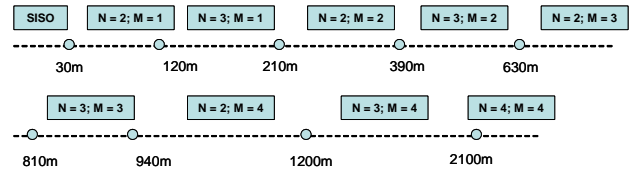

Fig. 17. Optimal  $N - M$  transmit and receive antennas set selection as a function of transmission distance,  $\Delta T_{syn} = 0.25T_s$ ,  $FER = 10^{-3}$  requirement, Rayleigh fading channel with power path-loss factor  $K = 2$ .

the analytic formula to perform the selection.

3) *Cooperative MISO vs. Relay Techniques*: The performance of relay techniques is limited by the decoding (or signal processing) process at the relay nodes. The error bit (or amplification noise) occurring at the relay node can not be always corrected at the destination node. Although with the same diversity gain, the performance of relay is always lower than MISO space time coding techniques. Therefore, in many cases, the total energy consumption of the relay technique is higher than the cooperative MISO technique. Fig. 18 shows the energy consumption of relay technique in comparison with SISO technique and cooperative MISO 2-1 technique.

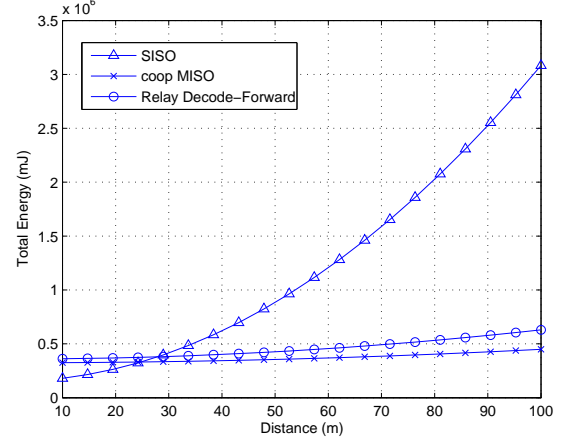

Fig. 18. Energy Consumption of relay technique vs. cooperative MIMO technique with two transmission nodes, error rate  $FER = 10^{-3}$ , power path-loss factor  $K = 2$ , source-relay distance  $d_1 = d/3$ .

However, in the presence of transmission errors, the performance of cooperative MISO technique decreases, leading to the increase of transmission energy consumption. The energy consumption of cooperative MISO 2-1 as a function of transmission synchronization error range is illustrated in Fig 19. For a small synchronization error range, the degradation is negligible but it becomes significant for a large error range, leading to a more required transmission energy [13] and less energy efficiency as

illustrated in Fig 19.

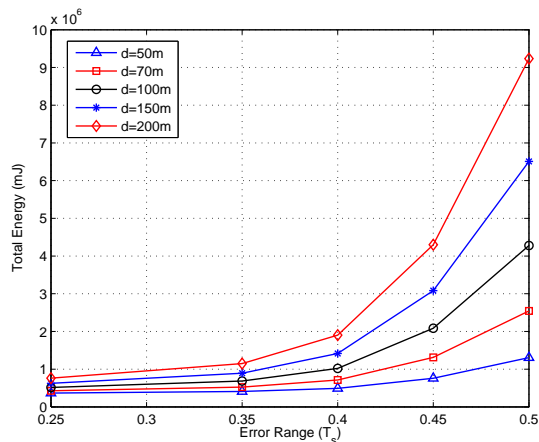

Fig. 19. Energy Consumption of cooperative MISO technique in function of transmission synchronization error range, two transmission nodes, error rate  $FER = 10^{-3}$  requirement, Rayleigh fading channel with the power path-loss factor  $K = 2$

The advantage of relay technique over cooperative is that relay is not affected by the un-synchronized transmission. Fig. 20 shows the energy consumption comparison of cooperative 2-1 and relay techniques with the path loss factor  $K = 3$  and the transmission synchronization error range  $\Delta T_{syn}$  is as large as  $0.5T_s$ . In this condition, the relay is clearly better than the cooperative MISO in terms of energy consumption.

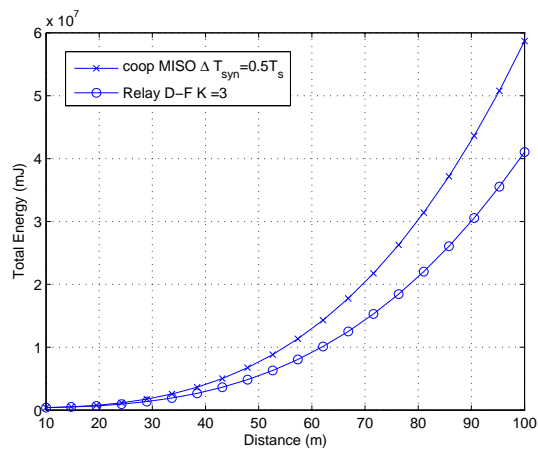

Fig. 20. Energy consumption of relay technique vs. cooperative MISO technique with two transmission nodes  $N = 2$ , power path-loss factor  $K = 3$ , error rate  $FER = 10^{-2}$ , transmission synchronization error range  $\Delta T_{syn} = 0.5T_s$  and source-relay distance  $d_1 = d/3$ .

In the case that the number of cooperative transmission nodes  $N$  is greater than two (e.g. three or four transmit nodes), the relay technique typically needs  $N$  transmis-

sion phases to transmit all signals from  $N-1$  relay nodes to the destination node (if orthogonal frequency channels are not considered). But a cooperative MISO technique needs typically 2 transmission phases (data exchange and MISO transmission phases). The transmission delay of the relay technique is longer than the cooperative MISO technique. However, the complexity of the relay is less than the cooperative MISO.

#### IV. CONCLUSION

Cooperative techniques can exploit the transmission diversity gain in order to increase the performance or to reduce the transmission energy consumption of the system. Some cooperative strategies, based on the multi-hop, cooperative relay and cooperative MIMO techniques, have been proposed in order to deploy energy efficient transmissions between the road infrastructures and vehicles in CAPTIV.

In this paper, it is shown that cooperative MISO and MIMO techniques are more energy-efficient than SISO and traditional multi-hop SISO techniques for medium and long range transmissions. An optimal cooperative MIMO scheme selection is also presented in order to find the optimal  $N-M$  antenna configuration for a given transmission distance.

Cooperative relay techniques provide attractive benefits for wireless distributed systems when the temporal and spatial diversity can be exploited to reduce the transmission energy consumption. Relay techniques are more efficient than the SISO technique, but still less efficient than cooperative MISO techniques in terms of energy consumption. The performance of relay techniques is not as good as cooperative MISO techniques for the same SNR. However, relay techniques are not affected by the un-synchronized transmission scheme. When the transmission synchronization error becomes significant, the performance of relay is better than the performance of cooperative MISO, leading to a better energy efficiency.

#### REFERENCES

- [1] J. Laneman and G. Wornell, "Energy-efficient antenna sharing and relaying for wireless networks," in *IEEE Wireless Communications and Networking Conference, WCNC*, vol. 1, 2000.
- [2] A. Sendonaris, E. Erkip, and B. Aazhang, "User cooperation diversity. Part I. System description," *IEEE Transactions on Communications*, vol. 51, no. 11, pp. 1927–1938, 2003.
- [3] J. Laneman, D. Tse, and G. Wornell, "Cooperative diversity in wireless networks: Efficient protocols and outage behavior," *IEEE Transactions on Information Theory*, vol. 50, no. 12, pp. 3062–3080, 2004.
- [4] H. Ilhan, I. Altunbas, and M. Uysal, "Cooperative Diversity for Relay-Assisted Inter-Vehicular Communication," in *Proc. IEEE Vehicular Technology Conference*, 2008.

- [5] M. Dohler, E. Lefranc, and H. Aghvami, "Space-time block codes for virtual antenna arrays," in *The 13th IEEE International Symposium on Personal, Indoor and Mobile Radio Communications*, vol. 1, 2002.
- [6] X. Li, "Energy efficient wireless sensor networks with transmission diversity," *Electronics Letters*, vol. 39, p. 1753, 2003.
- [7] J. Laneman and G. Wornell, "Distributed space-time-coded protocols for exploiting cooperative diversity in wireless networks," *IEEE Transactions on Information Theory*, vol. 49, no. 10, pp. 2415–2425, 2003.
- [8] S. Cui, A. Goldsmith, and A. Bahai, "Energy-efficiency of MIMO and cooperative MIMO techniques in sensor networks," *IEEE Journal on Selected Areas in Communications*, vol. 22, no. 6, pp. 1089–1098, 2004.
- [9] T. Nguyen, O. Berder, and O. Sentieys, "Cooperative MIMO schemes optimal selection for wireless sensor networks," *IEEE 65th Vehicular Technology Conference, VTC-Spring 07*, pp. 85–89, 2007.
- [10] K. Ito, N. Itoh, K. Sanda, and Y. Karasawa, "A Novel MIMO-STBC Scheme for Inter-Vehicle Communications at Intersection," in *IEEE 63rd Vehicular Technology Conference, 2006. VTC 2006-Spring*, vol. 6, 2006.
- [11] S. Konkaew, M. Chamchoy, and S. Promwong, "The Impact of Path Loss on Cooperative MIMO Transmission Scheme for Intelligent Transport System," in *International Symposium on Communications and Information Technologies, 2006. ISCIT'06*, 2006, pp. 516–520.
- [12] O. Berder, P. Quemerais, O. Sentieys, J. Astier, T. Nguyen, J. Menard, G. Le Mestre, Y. Le Roux, Y. Kokar, G. Zaharia *et al.*, "Cooperative communications between vehicles and intelligent road signs," in *8th International Conference on ITS Telecommunications, 2008. ITST 2008*, 2008, pp. 121–126.
- [13] T. Nguyen, O. Berder, and O. Sentieys, "Impact of Transmission Synchronization Error and Cooperative Reception Techniques on the Performance of Cooperative MIMO Systems," *IEEE International Conference on Communications, ICC Beijing*, pp. 4601–4605, 2008.
- [14] S. Alamouti, "A simple transmit diversity technique for wireless communications," *IEEE Journal on Selected Areas in Communications*, vol. 16, no. 8, pp. 1451–1458, 1998.
- [15] V. Tarokh, H. Jafarkhani, and A. R. Calderbank, "Space-time block codes from orthogonal designs," *IEEE Transactions on Information Theory*, vol. 45, no. 5, pp. 1456–1467, July 1999.
- [16] S. Jagannathan, H. Aghajan, and A. Goldsmith, "The effect of time synchronization errors on the performance of cooperative MISO systems," in *IEEE Global Telecommunications Conference Workshops, GlobeCom Workshops 2004*, 2004, pp. 102 – 107.
- [17] S. Cui, A. J. Goldsmith, and A. Bahai, "Modulation optimization under energy constraints," in *IEEE International Conference on Communications*, Anchorage, AK, USA, May 2003, pp. 2805 – 2811.