



**HAL**  
open science

## Advances and new technologies in Toxinology

Julien Barbier, Evelyne Benoit, Pascale Marchot, César Mattei, Denis Servent

► **To cite this version:**

Julien Barbier, Evelyne Benoit, Pascale Marchot, César Mattei, Denis Servent (Dir.). Advances and new technologies in Toxinology. SFET Publications, Gif-sur-Yvette, France, pp.186, 2010. hal-00738636

**HAL Id: hal-00738636**

**<https://hal.science/hal-00738636>**

Submitted on 21 May 2020

**HAL** is a multi-disciplinary open access archive for the deposit and dissemination of scientific research documents, whether they are published or not. The documents may come from teaching and research institutions in France or abroad, or from public or private research centers.

L'archive ouverte pluridisciplinaire **HAL**, est destinée au dépôt et à la diffusion de documents scientifiques de niveau recherche, publiés ou non, émanant des établissements d'enseignement et de recherche français ou étrangers, des laboratoires publics ou privés.

## Avancées et nouvelles technologies en Toxinologie

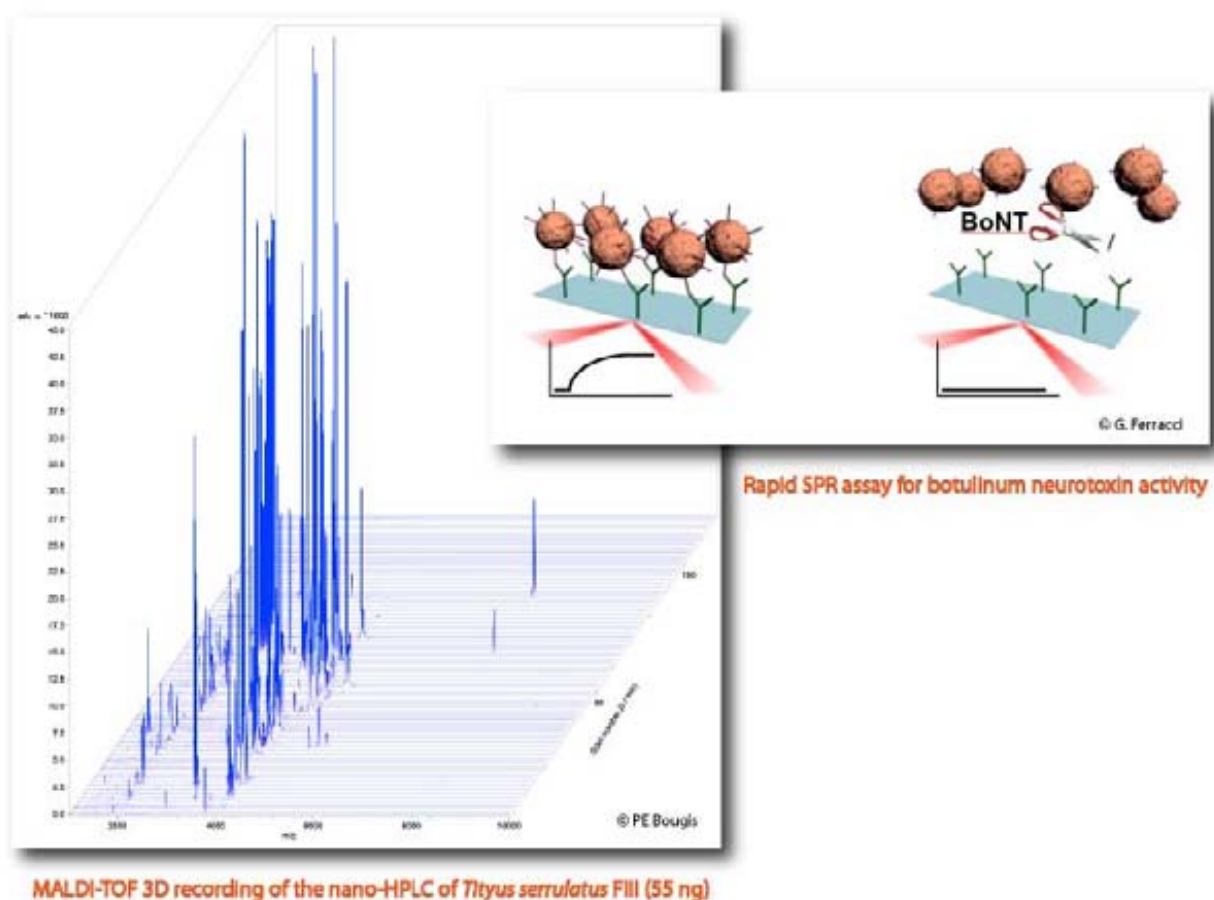

## *Advances and new technologies in Toxinology*

Comité d'édition – *Editorial committee* :

Julien BARBIER, Evelyne BENOIT, Pascale MARCHOT, César MATTEI, Denis SERVENT

**Société Française pour l'Etude des Toxines**  
***French Society of Toxinology***

Illustrations de couverture – *Cover pictures* :

**A gauche – Left** : Spectrogramme MALDI-TOF 3D « en ligne » de l'éluat d'une chromatographie nano-HPLC de la fraction FIII du venin du scorpion *Tityus serrulatus* (55 ng) – *On-line MALDI-TOF 3D recording of the nano-HPLC eluate of the Tityus serrulatus scorpion venom fraction FIII (55 ng)*. Copyright Pierre E. BOUGIS.

**A droite - Right** : Détection rapide de l'activité de la neurotoxine botulique (BoNT) par Résonance Plasmonique de Surface – *Rapid detection of a botulinum neurotoxin activity by Surface Plasmon Resonance*. Copyright Géraldine FERRACCI.

La collection « Rencontres en Toxinologie » est publiée à l'occasion des colloques annuels « Rencontres en Toxinologie » organisés par la Société Française pour l'Etude des Toxines (SFET). Les ouvrages imprimés parus de 2001 à 2007 ont été édités par Elsevier (Paris, France) puis la Librairie Lavoisier (Cachan, France). Depuis 2008, ils sont édités par la SFET et diffusés sur le site <http://www.sfet.asso.fr>, en libre accès pour les auteurs et les lecteurs.

*The series « Rencontres en Toxinologie » is published on the occasion of the annual Meetings on Toxinology organized by the French Society of Toxinology (SFET). The printed books of the series, from 2001 to 2007, were edited by Elsevier (Paris, France) and then the Librairie Lavoisier (Cachan, France). Since 2008, they are edited by the SFET and are available on-line on the site <http://www.sfet.asso.fr>, with free access for authors and readers.*

#### Titres parus – Previous titles

Explorer, exploiter les toxines et maîtriser les organismes producteurs  
*Cassian Bon, Françoise Goudey-Perrière, Bernard Poulain, Simone Puisseux-Dao*  
Elsevier, Paris, 2001  
ISBN : 2-84299-359-4

Toxines et recherches biomédicales  
*Françoise Goudey-Perrière, Cassian Bon, Simone Puisseux-Dao, Martin-Pierre Sauviat*  
Elsevier, Paris, 2002  
ISBN : 2-84299-445-0

Toxinogénèse – Biosynthèse, ingénierie, polymorphisme et neutralisation des toxines  
*Françoise Goudey-Perrière, Cassian Bon, André Ménez, Simone Puisseux-Dao*  
Elsevier, Paris, 2003  
ISBN : 2-84299-481-7

Envenimations, intoxications  
*Françoise Goudey-Perrière, Evelyne Benoit, Simone Puisseux-Dao, Cassian Bon*  
Librairie Lavoisier, Cachan, 2004  
ISBN : 2-7430-0749-4

Toxines et douleur  
*Cassian Bon, Françoise Goudey-Perrière, Max Goyffon, Martin-Pierre Sauviat*  
Librairie Lavoisier, Cachan, 2005  
ISBN : 2-7430-0849-0

Toxines et cancer  
*Françoise Goudey-Perrière, Evelyne Benoit, Max Goyffon, Pascale Marchot*  
Librairie Lavoisier, Cachan, 2006  
ISBN : 2-7430-0958-6

Toxines émergentes : nouveaux risques  
*Françoise Goudey-Perrière, Evelyne Benoit, Pascale Marchot, Michel R. Popoff*  
Librairie Lavoisier, Cachan, 2007  
ISBN : 978-2-7430-1037-9

Toxines et fonctions cholinergiques neuronales et non neuronales  
*Evelyne Benoit, Françoise Goudey-Perrière, Pascale Marchot et Denis Servent*  
Publications de la SFET, Châtenay-Malabry, France, 2008  
Epub on <http://www.sfet.asso.fr> - ISSN 1760-6004

Toxines et Signalisation - *Toxins and Signalling*  
*Evelyne Benoit, Françoise Goudey-Perrière, Pascale Marchot et Denis Servent*  
Publications de la SFET – SFET Editions, Châtenay-Malabry, France, 2009  
Epub on <http://www.sfet.asso.fr> - ISSN 1760-6004

Cet ouvrage est publié à l'occasion du colloque « 18<sup>èmes</sup> Rencontres en Toxinologie », organisé par la Société Française pour l'Etude des Toxines (SFET) les 13 et 14 décembre 2010 à Paris.

*This book is published on the occasion of the 18<sup>th</sup> Meeting on Toxinology, organized by the French Society of Toxinology (SFET) on December 13<sup>th</sup> and 14<sup>th</sup>, 2010, in Paris.*

Le comité d'organisation est constitué de – *The organizing committee is constituted of :*

Julien Barbier, Evelyne Benoit, Nathalie Hatchi, Pascale Marchot, César Mattéi, Michel R. Popoff & Denis Servent.

Le comité scientifique est constitué de – *The scientific committee is constituted of :*

Joseph Alouf, Julien Barbier, Evelyne Benoit, Nicolas Gilles, Max Goyffon, Daniel Ladant, Pascale Marchot, Marie-France Martin-Eauclaire, César Mattéi, Jordi Molgó, Michel R. Popoff & Denis Servent.

Le comité de rédaction est constitué de – *The redaction committee is constituted of :*

Romulo Araoz, Julien Barbier, Evelyne Benoit, Pierre-Edouard Bougis, Spencer Brown, José Manuel Cancela, Alain Créange, Frédéric Ducancel, Khalil Elmorjani, Philippe Favreau, Nicolas Gilles, Françoise Goudey-Perrière, Max Goyffon, Florian Nachon, Daniel Ladant, Christian Legros, Richard J. Lewis, Pascale Marchot, Marie-France Martin-Eauclaire, César Mattéi, Jordi Molgó, Michel R. Popoff, Denis Servent & Vitor Vasconcelos.

# Sommaire - Content

Pages

## Génomique, transcriptomique et protéomique – *Genomic, transcriptomic and proteomic*

<b>CONCO : the cone snail genome project for health</b> <i>Estelle BIANCHI, Philippe FAVREAU, Evelyne BENOIT, Jordi MOLGÓ, Frédéric DUCANCEL, Denis SERVENT, Tim STOCKWELL, Dietrich MEBS, Renée MÉNEZ, George MILJANICH, Reto STÖCKLIN</i>	7-9
<b>Sequencing the genome of <i>Conus consors</i> : preliminary results</b> <i>Tim STOCKWELL, Holly BADEN-TILLSON, Philippe FAVREAU, Dietrich MEBS, Frédéric DUCANCEL, Reto STÖCKLIN</i>	11-16
<b>Animal toxin precursors : from individual cloning to global transcriptomic studies</b> <i>Frédéric DUCANCEL, Yves TERRAT</i>	17-20
<b>Nano-liquid chromatography and mass spectrometry profiling of <i>Tityus serrulatus</i> scorpion venom</b> <i>Pierre E. BOUGIS, Maya BELGHAZI, Marie-France MARTIN-EAUCLAIRE</i>	21-23
<b>Mass spectrometric sequencing of peptidic toxins : an overview</b> <i>Loïc QUINTON, Julien ECHTERBILLE, Pierre ESCOUBAS, Nicolas GILLES, Edwin DE PAUW</i>	25-34

## Détection et neutralisation – *Detection and neutralisation*

<b>Recent developments in the detection of phycotoxins</b> <i>Philipp HESS, Elodie NICOLAU</i>	35-41
<b>Recent advances in marine biotoxins monitoring</b> <i>Riadh MARROUCHI, Evelyne BENOIT, Jordi MOLGÓ, Riadh KHARRAT</i>	43-50
<b>Current situation on receptor-based methods for marine toxins, and comparison with analytical solutions</b> <i>Luis M. BOTANA, Amparo ALFONSO, M. Carmen LOUZAO, Mercedes R. VIEYTES, Natalia VILARIÑO, Ana M. BOTANA, Carmen VALE</i>	51-54
<b>New tools to discover active molecules in venoms : from theory to practice</b> <i>Philippe FAVREAU, Estelle NEVEU, Milena MAVER, Reto STÖCKLIN, Daniel BERTRAND</i>	55-62
<b>Scorpion antivenoms : progresses and challenges</b> <i>Muhammad ZAHID, Sonia ADI-BESSALEM, Julien MUZARD, Matthieu JUSTE, Marie-France MARTIN-EAUCLAIRE, Nicolas AUBREY, Fatima LARABA-DJEBARI, Philippe BILLIALD</i>	63-68
<b>Ingénierie moléculaire des antitoxines : avantages des "Nanobodies" de Camélidés pour l'immunothérapie antivenimeuse</b> <i>Balkiss BOUHOUALA-ZAHAR, Issam HMILA, Rahma BEN ABDERRAZEK, Naima ABIDI, Serge MUYLDERMANS, Mohamed EL AYEYB</i>	69-77
<b>Anticorps recombinants humanisés, issus de primates non humains, pour la neutralisation des toxines</b> <i>Philippe THULLIER, Siham CHAHBOUN, Jacques MATHIEU, Thibaut PELAT</i>	79-83
<b>Functional assays for toxins of the CBRN threats</b> <i>Eric EZAN, François BECHER, Elodie DURIEZ</i>	85-88
<b>Development of surface plasmon resonance-based assays for botulinum neurotoxin activity</b> <i>Christian LEVEQUE, Géraldine FERRACCI, Michael SEAGAR</i>	89-92
<b>Test rapides, utilisables sur le terrain, pour la détection de toxines</b> <i>Hervé VOLLAND, Patricia LAMOURETTE, Michel-Robert POPOFF, Christelle MAZUET, Marie-Claire NEVERS, Julie DANO, Cécile FERAUDET-TARISSE, Bernard LAGOUTTE, Christophe CREMINON</i>	93-97
<b>Use of nano-liquid chromatography and mass spectrometry to identify a new <i>Cerastes cerastes</i> venom phospholipase A2</b> <i>Fatah CHERIFI, Jean-Claude ROUSSELLE, Abdelkader NAMANE, Fatima LARABA-DJEBARI</i>	99-100

## Structure et interaction – Structure and interaction

- Bacterial type IV secretion systems : structure of the core and outer-membrane complexes** 101-104  
*Rémi FRONZES*
- Three-dimensional structures of two neurotoxic phospholipases A<sub>2</sub>, ammodytoxin and crotoxin, are resolved : impact of structural differences on functional effects** 105-108  
*Grazyna FAURE, Frederick SAUL*
- Molecular dynamics studies of Acetylcholine Binding Protein with spiroimine toxins** 109-114  
*Rómulo ARÁOZ, Laurent CHABAUD, Catherine GUILLOU, Jordi MOLGÓ, Bogdan I. IORGA*
- Engineering KcsA-Kv1.x chimeric proteins for studying toxin-channel interactions** 115-118  
*Christian LEGROS, Max GOYFFON, Catherine GUETTE*
- HTRF<sup>®</sup> et Tag-lite<sup>®</sup>, de nouvelles technologies de fluorescence permettant l'étude d'évènements moléculaires** 119-126  
*Eric TRINQUET*
- Bio-inspired sensors based on the assembly of receptors and ion channels** 127-131  
*Lydia CARO, Christophe MOREAU, Jean REVILLOUD, Michel VIVAUDOU*

## Toxines bactériennes et divers – Bacterial toxins and miscellaneous

- Black spot, black death and black pearl : tales of bacterial effectors** 133-137  
*Anne-Marie KRACHLER, Kim ORTH*
- L'hémolysine gamma de *Staphylococcus aureus* : plus qu'une toxine formant des pores** 139-147  
*Mira TAWK, Benoît-Joseph LAVENTIE, Emmanuel JOVER, Bernard POULAIN, Gilles PREVOST*
- A new system for expressing recombinant animal toxins in *E. coli* ?** 149-152  
*Badreddine DOUZI, Arie GEERLOF, Hervé DARBON, Nicolas GILLES, Pascale MARCHOT, Renaud VINCENTELLI*
- Toxines issues de bactéries, cyanobactéries, champignons, organismes marins et serpents ciblant les cholinestérases : utilisation thérapeutique potentielle dans le traitement de la maladie d'Alzheimer ?** 153-166  
*Nicole PAGES, Françoise GOUDEY-PERRIERE, Patrick BRETON*
- The changing profile of marine toxins in Europe** 167-174  
*Amparo ALFONSO, Paula RODRIGUEZ, Paz OTERO, Vitor VASCONCELOS, Joana AZEVEDO, Marisa SILVA, Paulo VALE, Panagiota KATIKOU, Dimitrios GEORGANTELIS, Jordi MOLGÓ, Luis M. BOTANA*
- Rapid intraspecimen evolution of cone snail venom composition : multiplying pharmacological profiles ?** 175-176  
*Daniel BIASS, Sébastien DUTERTRE, Philippe FAVREAU, Reto STÖCKLIN*
- Immunomodulatory effects of *Androctonus australis hector* scorpion venom on macrophage activation** 177-178  
*Djelila HAMMOUDI-TRIKI, Hajer SAIDI, Fouzia GUESTINI, Lamia ALOUACHE, Amina MENDIL, Sassia SAMI-MERAH, Sonia ADI-BESSALEM, Fatima LARABA-DJEBAR*
- Local inflammatory response induced by *Androctonus australis hector* venom and its toxic fraction Ftox-G50** 179-180  
*Rym BOUKARI, Sassia SAMI-MERAH, Fatima LARABA-DJEBARI*
- Pharmacological assessment of inflammatory mediators after *Androctonus australis hector* envenomation : involvement of histamine H1 receptor** 181-183  
*Sonia ADI-BESSALEM, Sassia SAMI-MERAH, Amina MENDIL, Djelila HAMMOUDI-TRIKI, Fatima LARABA-DJEBARI*

## CONCO : the cone snail genome project for health

Estelle BIANCHI<sup>1</sup>, Philippe FAVREAU<sup>1</sup>, Evelyne BENOIT<sup>3</sup>, Jordi MOLGO<sup>3</sup>,  
Frédéric DUCANCEL<sup>4</sup>, Denis SERVENT<sup>4</sup>, Tim STOCKWELL<sup>5</sup>, Dietrich MEBS<sup>2,6</sup>,  
Renée MÉNEZ<sup>2</sup>, George MILJANICH<sup>2,7</sup>, Reto STÖCKLIN<sup>1,2\*</sup>

<sup>1</sup> Atheris Laboratories, case postale 314, CH-1233 Bernex-Geneva, Switzerland ; <sup>2</sup> The Toxinomics Foundation, chemin d'Alcire 1, CH-1228 Plan-les-Ouates, Switzerland ; <sup>3</sup> CNRS, Institut de Neurobiologie Alfred Fessard - FRC2118, Laboratoire de Neurobiologie et Développement – UPR3294, 1 avenue de la Terrasse, F-91198 Gif sur Yvette Cedex, France ; <sup>4</sup> iBiTec-S, CEA de Saclay, F-91191 Gif sur Yvette, France ; <sup>5</sup> J. Craig Venter Institute, 9704 Medical Center Drive, Rockville, Maryland, 20850, USA ; <sup>6</sup> Zentrum der Rechtsmedizin, University of Frankfurt, D-60596 Frankfurt, Germany ; <sup>7</sup> Airmid Inc., Redwood City, CA 94061, USA

\* Corresponding author ; Tel : +41 (0)22 850 05 85 ; E-mail : [reto.stocklin@atheris.ch](mailto:reto.stocklin@atheris.ch)

---

### Abstract

CONCO is a post-genomic project using applied venomics of cone snails for accelerated, cheaper, safer and more ethical production of innovative biomedical drugs. The project aims at characterising from the genomic up to potential therapeutic properties all the putative bioactive compounds that can be synthesised by a cone snail species, the *Conus consors*.

### CONCO : le séquençage du génome d'un cône marin, un projet de santé

CONCO est un projet post-génomique, utilisant la vénomique appliquée aux escargots marins afin de produire des nouveaux médicaments innovants, et ceci de façon rapide, éthique, moins chère et plus sûre. Le but de ce projet est de caractériser tous les composés présumés bioactifs qui peuvent être synthétisés par un cône, le *Conus consors*, en allant du génome aux propriétés thérapeutiques potentielles.

**Keywords :** Bioinformatics, cone snail, *Conus consors*, drug discovery, genome, peptidome, proteome, transcriptome, venom, venomics.

---

The CONCO project was initiated in February 2007, aiming to deliver a palette of research tools and platforms to identify and bring to the market new drugs from venomous marine cone snails.

Venomous animals represent goldmines of highly selective and potent bioactives, some already successfully led to the development of new drugs. The latest FDA approved example is Prial<sup>®</sup>, a venom-derived peptide originating from *Conus magus*. Cone snails are predators that use sophisticated harpoons to inject their venom in their prey. Below are pictures of *Conus consors*, a fish hunter, its shell and harpoon. Once hit by the harpoon, the fish is paralysed by the venom in less than a second and immediately swallowed by the snail. The venom of each animal is made of hundreds of highly potent and selective components, mostly small proteins (peptides).



**Figure 1.** *Conus consors* alive in an aquarium with its siphon to breathe (one eye can be seen as small black spot at the basis of the siphon nearby the mouth and proboscis venomous apparatus), its shell and deadly harpoon injecting the venom and paralysing a fish within seconds before it is swallowed and eaten. Photos by Thierry Parel and Jean-Jacques Soin. See [www.conco.eu](http://www.conco.eu) for more information.

**Figure 1.** *Conus consors* vivant dans un aquarium, avec son siphon pour respirer (un œil est visible, le petit point noir à la base du siphon à côté de la bouche et du proboscis de l'appareil venimeux), sa coquille et son harpon mortel permettant l'injections du venin et paralysant un poisson en quelques secondes avant d'être avalé et mangé. Photos de Thierry Parel et Jean-Jacques Soin. Pour plus d'information, voir [www.conco.eu](http://www.conco.eu).



Moreover, the project includes educational and general public promotional activities with the goal to preserve the rich potential of the worldwide biodiversity. To initiate and support this project, several marine expeditions were accomplished in the Pacific Ocean to collect live cone snails and to prepare a documentary movie. Cone snails covering more than 100 different species have been cautiously collected to date, adhering to regulations and biodiversity preservation.



**Figure 2.** Pictures from the CONFIELD-2 expedition in the Chesterfield Islands, New Caledonia (by Roberto Rinaldi and Reto Stöcklin).

**Figure 2.** Photos de l'expédition CONFIELD-2 aux îles Chesterfield en Nouvelle-Calédonie (de Roberto Rinaldi et Reto Stöcklin).

A method for the milking of live animals kept in aquariums has been established, which leads to ongoing venom production and fascinating studies on inter- and intra-specific, as well as intra-specimen venom variations over time (Dutertre *et al.*, 2010) and differences in venom content depending on its extraction, milking vs. dissection (Blass *et al.*, 2009, 2010). The genome and transcriptome of *Conus consors* is currently exhaustively studied (Stockwell *et al.*, 2010). Large amounts of venom are fractionated and submitted to proteomic analyses in order to generate a biochemically characterised "natural library" of compounds. Large scale synthesis of each identified candidate is achieved to form a "synthetic library" of compounds. The biological activity of these two libraries is investigated on a panel of physiological targets that are well recognised for their therapeutic value. Selected hits are optimised and validated *in vivo*. A publicly accessible web-based database has been developed and annotated to integrate and share all the knowledge generated by the project.

Already one lead compound, XEP-018, was identified in the venom of *Conus consors* and was submitted to patent application with *in vivo* proof-of-concept of its valuable therapeutic properties. During the project, the pain control and local anaesthesia efficacy of XEP-018 is evaluated through pre-clinical development. In CONCO, highly competitive European scientists from 19 laboratories, including the non-for-profit Toxinomics Foundation (Ménez *et al.*, 2006), playing a central role, plus US researchers from the prestigious J. Craig Venter Institute (that sequenced the human genome) joined their forces to investigate the application of post-genomic studies using the most advanced methods of functional genomics ("venomics") and bioinformatics for the high-throughput screening of new drugs. Our approach will lay the foundation for a new generation of cost-effective biopharmaceuticals for unmet medical needs.

In the meantime, different drug discovery and development approaches were initiated either with the academic and industrial partners, combining: (a) advanced analysis technologies such as proteomic and genomic approaches with completed transcriptomes and hundreds of novel conopeptide sequences identified (a major goal of the project is to sequence the cone snail genome to better understand the venomous function), (b) drug discovery based on target-driven cell-based and enzymatic assays that have led to the identification of several innovative hits, (c) pre-clinical development focusing with an exhaustive pharmacological profiling of the lead compound XEP-018 which confirmed its drugability, that is aimed to become an anti-pain/analgesic drug and (d) structure-function studies with the 3D investigation of XEP-018 by NMR, the design of novel generations of improved XEP-018 with greater specificity and efficacy in the vision of the life cycle management of the drug and for a better understanding of its mode of action.

Finally, a big part of the project is dedicated to education and dissemination of the knowledge, through the publication of several articles in public newspapers, as well as participation to scientific and public conferences and training courses, to public exhibitions, radio and television appearances.

All these activities are part of the CONCO project and are of great interest not only for scientists and pharmaceutical, but also for everyone as it highlights the importance of preserving the biodiversity, not only for itself, but also for ourselves.

**Acknowledgements.** This publication has been performed as part of the CONCO cone snail genome project for health ([www.conco.eu](http://www.conco.eu)) funded by the European Commission within the 6<sup>th</sup> Framework Program (LIFESCIHEALTH-6 Integrated Project LSHB-CT-2007, contract number 037592). We are most grateful to the French Institute of Research for the Development (IRD), and to the governments of New Caledonia and French Polynesia for their support.

## References

- Biass D, Dutertre S, Gerbault A, Menou JL, Offord R, Favreau P, Stöcklin R (2009) Comparative proteomic study of the venom of the piscivorous cone snail *Conus consors*. *J Proteomics*, **72**: 210-218
- Biass D, Dutertre S, Favreau P, Stöcklin R (2010) Rapid intraspecimen evolution of cone snail venom composition: multiplying pharmacological profiles ? In *Advances and new technologies in Toxinology*. Barbier J, Benoit E, Marchot P, Mattéi C and Servent D (eds) pp 175-176. SFET Editions, Gif sur Yvette, France, Epub on <http://www.sfet.asso.fr> (ISSN 1760-6004)
- Dutertre S, Biass D, Stöcklin R, Favreau P (2010) Dramatic intraspecimen variations within the injected venom of *Conus consors*: an unsuspected contribution to venom diversity. *Toxicon* **55**: 1453-1462
- Ménez A, Stöcklin R, Mebs D (2006) 'Venomics' or: The venomous systems genome project. Editorial. *Toxicon* **47**: 255-259
- Stockwell T, Baden-Tillson H, Ducancel F, Favreau P, Mebs D, Stöcklin R (2010) Sequencing the genome of *Conus consors*: preliminary results. In *Advances and new technologies in Toxinology*. Barbier J, Benoit E, Marchot P, Mattéi C and Servent D (eds) pp 11-16. SFET Editions, Gif sur Yvette, France, Epub on <http://www.sfet.asso.fr> (ISSN 1760-6004)
-



## Sequencing the genome of *Conus consors* : preliminary results

Tim STOCKWELL<sup>1\*</sup>, Holly BADEN-TILLSON<sup>1</sup>, Philippe FAVREAU<sup>2</sup>, Dietrich MEBS<sup>3,4</sup>, Frédéric DUCANCEL<sup>5</sup>, Reto STÖCKLIN<sup>2,3</sup>

<sup>1</sup> J. Craig Venter Institute, 9704 Medical Center Drive, Rockville, Maryland, 20850, USA ; <sup>2</sup> Atheris Laboratories, case postale 314, CH-1233 Bernex-Geneva, Switzerland ; <sup>3</sup> The Toxinomics Foundation, chemin d'Alcire 1, CH-1228 Plan-les-Ouates, Switzerland ; <sup>4</sup> Zentrum der Rechtsmedizin, University of Frankfurt, D-60596 Frankfurt, Germany ; <sup>5</sup> iBiTec-S, CEA de Saclay, F-91191 Gif sur Yvette, France

\* Corresponding author ; Tel : +1 (301) 795 7377 ; Fax : +1 (301) 294 3142 ; E-mail : [tstockwell@jcvl.org](mailto:tstockwell@jcvl.org)

---

### Abstract

The first genome sequence of a venomous marine animal focusing on the venomous function, the cone snail *Conus consors*, holds the promise of providing the master list of bioactive compounds that are available to the organism for composing its venom. Peptidomic and proteomic studies have shown 100's of different peptides and proteins exist in the venom obtained from individual specimens, intra-specific variations were observed and even the composition of venom from the same specimen can vary drastically over time (Blass et al., 2009, 2010; Dutertre et al., 2010). The results of preliminary analysis of the genome using next generation sequencing of short DNA fragments are presented.

### Le séquençage du génome de *Conus consors* : résultats préliminaires

Le premier séquençage du génome d'un organisme venimeux focalisé sur la fonction venimeuse va permettre d'obtenir une liste exhaustive de toutes les molécules bioactives à disposition, que l'animal peut exploiter dans son arsenal venimeux. Des études peptidomiques et protéomiques du *Conus consors* ont révélé la présence de centaines de peptides et protéines dans le venin obtenu à partir de spécimens uniques. Par ailleurs, d'importantes variations intra-spécifiques ont été observées et il a même été possible de démontrer que la composition du venin de spécimens isolés peut varier drastiquement au cours du temps (Blass et al., 2009, 2010; Dutertre et al., 2010). Les résultats d'études préliminaires utilisant des techniques de dernière génération de séquençage génomique de petits fragments d'ADN sont présentés dans cet article.

**Keywords :** Cone snail, genome, pyrosequencing, venomous function.

---

## Introduction

The Venomics initiative was launched in 2003 by members of the International Society on Toxinology and joined by the J. Craig Venter Institute (JCVI) in 2005 (Ménez *et al.*, 2006). In 2007, as part of the Cone Snail Genome Project for Health, a Consortium of CONCO partners was created, with the goal of performing the first genome sequencing of a venomous marine animal. Although originally planned as a light (<1.0x) coverage of the *Conus consors* genome using Sanger sequencing technology, advances in Next Generation sequencing technology has enabled the project to set a goal of >7.0x coverage of the genome. This change of sequencing strategy has introduced some challenges due to corresponding changes in DNA amplification methods, but new protocols should overcome these difficulties.

## Methods and Results

### DNA extraction

The foot tissue samples from various species of *Conus* from New Caledonia were first made available in 2008. Given the precious nature of *C. consors* samples originating from the remote Chesterfield Islands (only 3 foot samples were available for analysis), *C. leopardus* foot samples NC070313BM and NC070313BL were first used to evaluate the performance of available DNA extraction protocols. The purpose was to determine which protocol would produce the most DNA of acceptable molecular weight (greater than 10 kbp dsDNA) per mg of tissue. The protocols evaluated were:

- DNA extraction using Qiagen's M48 robotic system with "tissue" protocol. Starting material was frozen foot tissue pulverized to powder by mortar and pestle under liquid nitrogen.
- DNA extraction using Pressure Cycling Technology (PCT) protocol from Pressure BioSciences Incorporated (Gross *et al.*, 2008). The protocol used both the PCT Shredder to disrupt the tissue matrix

followed by using the PCT barocycler to extract DNA from cells. Starting material was frozen foot tissue.

- DNA extraction using EDTA/EGTA/SDS/Proteinase K protocol developed at JCVI, which is a modification of standard techniques (Sambrook *et al.*, 1989). Starting material was frozen foot tissue pulverized to powder by mortar and pestle under liquid nitrogen.

Based on size gel and mass gel analyses, the EDTA/EGTA/SDS/Proteinase K protocol extracted the most DNA of acceptable molecular weight per mg of foot tissue. The DNA extraction protocol was repeated using EDTA/EGTA/SDS/Proteinase K on *C. consors* foot tissue, sample id CH070619AB. Initially, 149.8 mg of tissue was used, yielding approximately 28 µg of high molecular weight (greater than 40 kb) DNA (*Figure 1*).

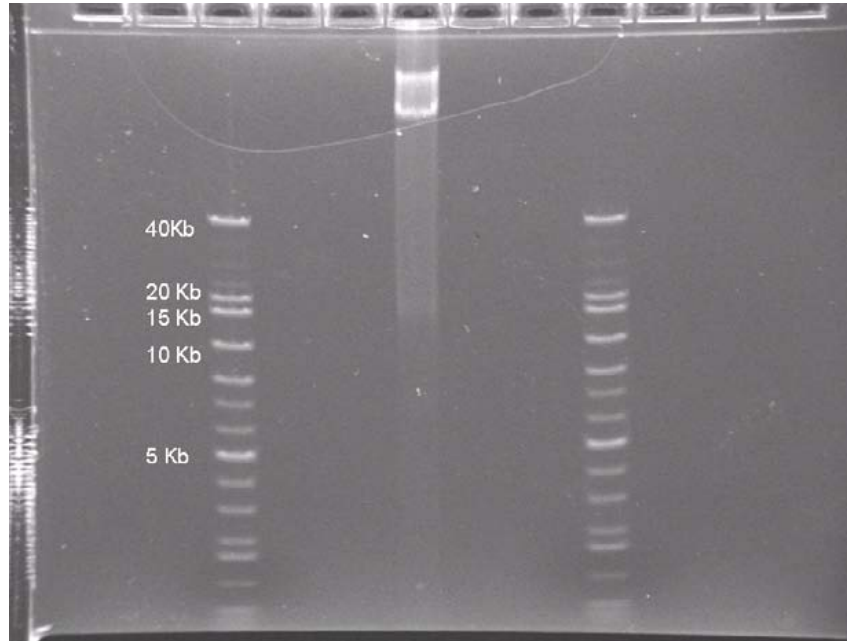

**Figure 1.** *C. consors* genomic DNA after initial extraction. 0.8% E-gel FIGE gel ran for 3 hours. The conditions were as follows: Forward 72 volts, initial switch 0.1 seconds, final switch 0.6 seconds with a linear ramp and reverse 48 volts, initial switch of 0.1 seconds, final switch of 0.6 seconds with a linear ramp. The ladder is the Invitrogen 1kb extension ladder.

**Figure 1.** ADN génomique de *C. consors* après extraction. Electrophorèse par inversion de champ (FIGE) en gel 0,8% pendant 3 heures. Les conditions sont : (i) courant aller de 72 volts, inversion initiale toutes les 0,1 secondes, inversion finale toutes les 0,6 secondes suivant une pente linéaire et (ii) courant retour de 48 volts, inversion initiale toutes les 0,1 secondes, inversion finale toutes les 0,6 secondes suivant une pente linéaire. Marqueurs de poids moléculaire: 1kb d'Invitrogen.

### Initial DNA isolation

*C. consors* genomic DNA (gDNA) was initially isolated using the following steps:

- 149.8 mg of *C. consors* foot tissue was ground to powder using mortar and pestle under liquid nitrogen. The pulverized tissue was resuspended in TE/EGTA buffer.
- Cells were lysed by three repeated freeze/thaw cycles, and treated with lysozyme and Proteinase K. DNA was extracted with buffer saturated phenol. Overnight precipitation in 4°C ethanol.
- DNA extraction with Cetyltrimethylammonium Bromide (CTAB) buffer to remove phenolics, polysaccharides, and other PCR inhibitors.
- Back extraction of CTAB interface with chloroform to recover additional gDNA.
- Phenol, phenol/chloroform extraction, ethanol precipitation, DNA resuspension.

It was noted that even after multiple rounds of extraction/precipitation, the *C. consors* DNA exhibited an unusual brown-purple pigment and a relatively high viscosity.

### Species confirmation

PCR using both 16S rRNA and 18S rRNA specific primers was performed on the extracted *C. consors* DNA. Sequences of primers used were:

- 16S\_fwd: 5'-GTTTATCAAAAACATGGCTTCGGG-3'
- 16S\_rev: 5'-CCGGTCTGAACTCAGATCACGT-3'
- 18S\_fwd: 5'-GTTCCGATTCCGGAGAGGA-3'
- 18S\_rev: 5'-CTTGGCAAATGCTTTCGC-3'

An aliquot of the PCR products were run on an agarose gel to confirm expected PCR product sizes. The 16S and 18S products were then cloned into TOPO TA vector and Sanger sequenced to confirm species identity. The 16S and 18S sequences had highest similarity to *C. consors* 16S and 18S sequences at NCBI/GenBank, and perfectly-matched the 16S and 18S sequences assembled from EST data provided by CONCO partner Skuld-Tech.

**Initial Roche/454 results**

High molecular weight *C. consors* genomic DNA (7 µg) was sheared to 500-800 bp in size using nebulization. Any small fragments generated during nebulization were removed by purification of size-selected DNA from an agarose gel. Size distribution was confirmed using Agilent DNA 7500 chip (Figure 2). A 454 Titanium fragment library was constructed. The quality of the single stranded DNA library was checked by an Agilent RNA Pico 6000 chip (Figure 3).

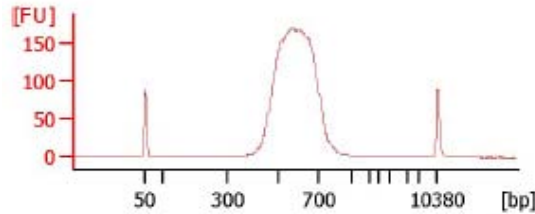

**Figure 2.** Agilent DNA 7500 Chip profile of the *C. consors* 454 Titanium library after gel size selection. The peaks at 50 bp and 10380 bp are internal markers for the chip.

**Figure 2.** Puce Agilent ADN 7500: profil de migration de la banque 454 Titanium d'ADN génomique de *C. consors* après nébulisation. Les pics de 50 et 10380 bp correspondent à des marqueurs de poids moléculaires internes.

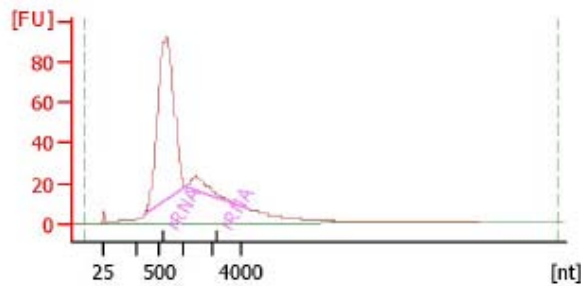

**Figure 3.** Agilent RNA Pico 6000 chip profile of the 454 Titanium fragment library for *C. consors*. The peak at 25 bp is an internal marker for the chip.

**Figure 3.** Puce Agilent ARN Pico 6000: profil ARN de la banque 454 Titanium d'ADN génomique de *C. consors* après nébulisation. Le pic à 25 bp correspond à un marqueur interne de poids moléculaire.

Multiple attempts to construct a 3 kbp insert size 454 mate pair library were performed, but analysis of results using Agilent RNA Pico 6000 chip (Figure 4) indicated these were unsuccessful.

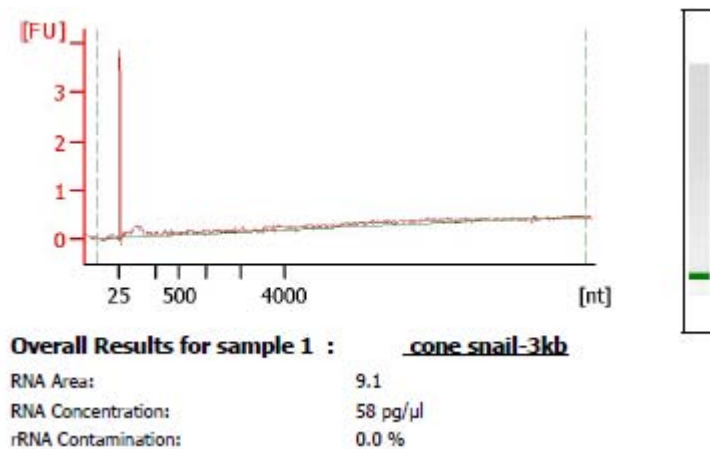

**Figure 4.** Agilent RNA Pico 6000 chip profile of an unsuccessful 454 Titanium mate pair library for *C. consors*. The peak at 25 bp is an internal marker for the chip.

**Figure 4.** Puce Agilent ARN Pico 6000 : profil de l'échec de la construction d'une banque 454 Titanium de paires de compagnons (« mate paire library ») de *C. consors*. Le pic à 25 bp correspond à un marqueur interne de poids moléculaire.

Three full plates of the *C. consors* 454 Titanium fragment library were run on the Roche/454 Genome Sequencer (Margulies *et al.*, 2005). These three full plate runs produced 2,711,556 sequence reads (average 903,852 reads per run) and 834,999,097 bp of data (average 278,333,032 bp per run and 308 bp per read). These statistics were below expectations of at least 1,000,000 reads per run and average read length of 400 bp, so a detailed analysis of the data was initiated. A read length histogram (Figure 5) showed an unexpected peak at an approximate length of 60 bp. Analysis of the sequence content of the reads in this peak (reads ranging in length from 41 to 141 bp) indicated a large portion of the reads terminating in simple sequence repeats, predominately di-nucleotide repeats. Analysis of the full set of reads, searching for di-nucleotide repeats of at least 10 units in length, indicate that 8.7% of reads contain (CA)<sub>10+</sub>, 5.4% of reads contain (GA)<sub>10+</sub>, 0.9% of reads contain (TA)<sub>10+</sub>, and 0.3% of reads contain (CG)<sub>10+</sub>.

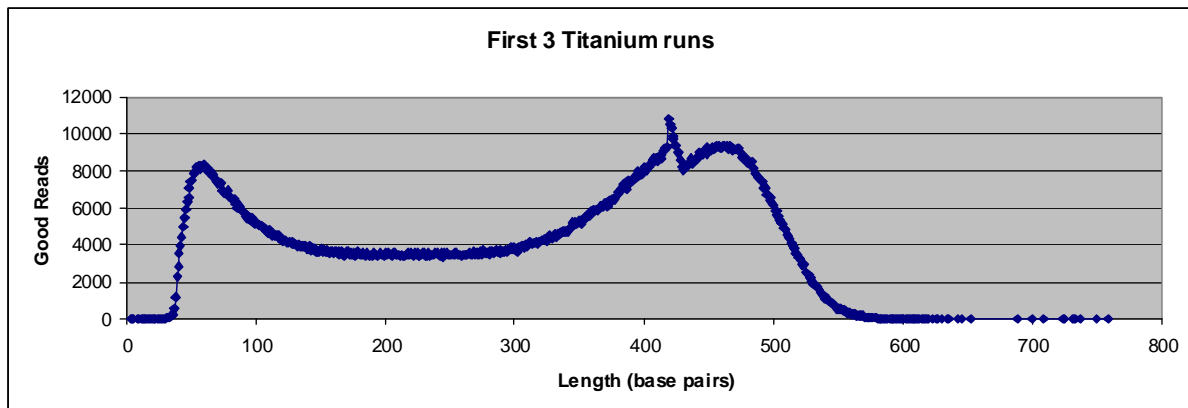

**Figure 5.** Sequence length histogram of good reads from first 3 runs of *C. consors* gDNA 454 Titanium fragment library.

**Figure 5.** Profil de taille des séquences issues des 3 premiers tours de séquençage de la banque 454 Titanium d'ADN génomique.

### Confirmation of di-nucleotide repeat content in gDNA using Sanger Sequencing

To rule out any type of artifact arising from use of 454 Titanium technology, a small insert (2 kbp) plasmid library was constructed and 384 clones Sanger-sequenced (Sanger *et al.*, 1977) bi-directionally on ABI 3730xl DNA Analyzers to independently assess the di-nucleotide content of *C. consors* genomic DNA. Analysis of the Sanger sequence reads indicated an even higher percentage of regions containing di-nucleotide repeats as compared to the Roche/454 sequencing; 27.6% of reads contain (CA)<sub>10+</sub>, 15.4% of reads contain (GA)<sub>10+</sub>, 1.8% of reads contain (TA)<sub>10+</sub>, and 2.3% of reads contain (CG)<sub>10+</sub>.

### Initial Illumina/Solexa results

Multiple attempts to produce Illumina/Solexa sequence data (Bentley *et al.*, 2008) using the initial isolation of *C. consors* gDNA were unsuccessful. The addition of human gDNA as an internal positive control resulted in only the spike-in control generating output sequence data.

### Additional Roche/454 results

Alternative emulsion PCR protocols were evaluated in an attempt to obtain high fidelity replication of di-nucleotide repeat-containing fragments that could then allow successful pyrosequencing "read-through" of the di-nucleotide repeats. No alternative protocol performed better than the standard emulsion PCR protocol. It was decided to proceed with an additional 15 plates of Roche/454 pyrosequencing of the fragment library using Titanium chemistry. The total sequencing obtained by Roche/454 pyrosequencing of the fragment library was 18 plates, 17,965,569 reads, and 5,538,744,227 bp of sequence data.

### Subsequent DNA isolation

In parallel with high throughput sequencing, we explored alternative protocols for isolating *C. consors* genomic DNA that was free of any pigments and exhibited a typical viscosity. The following steps were used:

- 148 mg of *C. consors* foot tissue was ground to powder using mortar and pestle under liquid nitrogen. The pulverized tissue was resuspended in TE/EGTA buffer.
- Cells were lysed by three repeated freeze/thaw cycles. Further treated with Lysozyme and Proteinase K. DNA was extracted with buffer saturated phenol. Overnight precipitation in 4°C ethanol.
- DNA extraction with CTAB/Polyvinylpolypyrrolidone (PVPP) buffer (Lodhi *et al.*, 1994) to remove phenolics, polysaccharides, and other PCR inhibitors.
- DNA purification on a hydroxyapatite column (Bernardi, 1965). Seven column volumes of step gradient of 0.4 M phosphate and 1.0 M phosphate at 60°C were used to elute the gDNA from the column.
- Pooling of fractions containing *C. consors* gDNA.

The *C. consors* genomic DNA isolated using this revised protocol did not exhibit any pigment and was of typical viscosity. Analysis on 0.8% agarose gel indicated the pooled DNA was larger than 10 kbp in size (Figure 6). UV/Vis spectrum of the pooled DNA (Figure 7) showed a 260nm/280nm absorbance ratio of 1.78, and a 260nm/230nm absorbance ratio of 1.99.

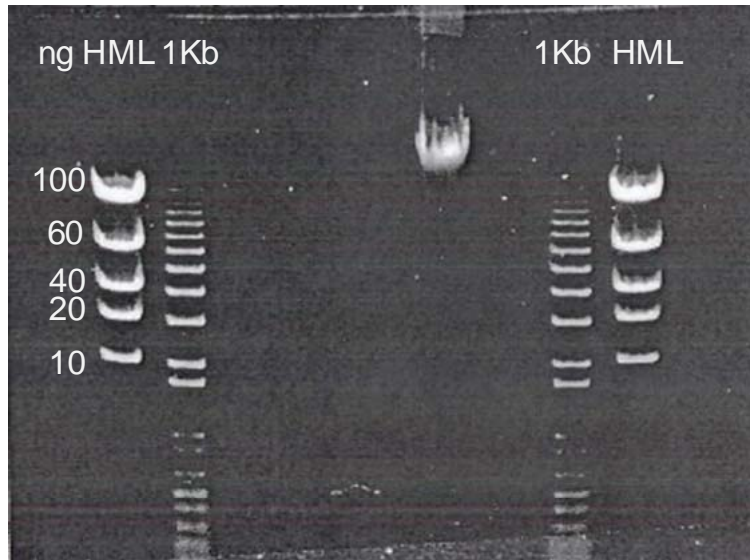

**Figure 6.** *C. consors* genomic DNA after subsequent DNA isolation using CTAB/PVPP and hydroxyapatite column protocol and pooling fractions. 0.8% E-gel shows a tight band greater than 10 kb.

**Figure 6.** ADN génomique de *C. consors* après une étape supplémentaire de purification en tampon CTAB/PVPP sur une colonne d'hydroxyapatite. Le gel d'agarose révèle une bande intense de plus de 10 kb.

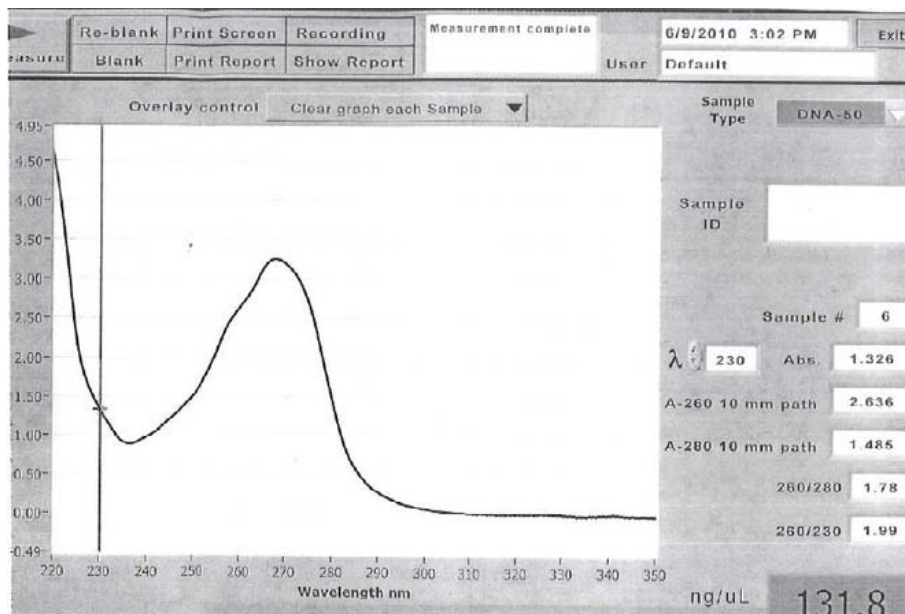

**Figure 7.** UV/Visible spectrum of the *C. consors* gDNA obtained from the subsequent DNA isolation using CTAB/PVPP and hydroxyapatite column.

**Figure 7.** Spectre UV/Visible de l'ADN génomique de *C. consors* obtenu après purification sur colonne d'hydroxyapatite et tampon CTAB/PVPP.

**Additional Illumina/Solexa results**

The *C. consors* gDNA from the improved isolation protocol was used to construct an Illumina/Solexa 300 bp paired end library. This library was sequenced on a single lane of an 8 lane flowcell, using a 100 bp paired end read protocol on an Illumina/Solexa GAII sequencer. This single lane produced a total of 56,004,872 reads, and a total of 5,375,369,341 bp of sequence data.



### Whole genome assembly

Whole genome assembly was performed using two different programs. CLC Bio's *clc\_novo\_assemble* (CLC Bio, 2010) and Roche/454's GS De Novo Assembler (Miller *et al.*, 2010) produced similar results. The *clc\_novo\_assemble* produced 2,686,048 contigs containing 1,393,699,035 bp of sequence data, had a contig maximum length of 31,631 bp and a contig N50 value of 588 bp. The GS De Novo Assembler produced 2,091,744 contigs containing 975,801,793 bp of sequence data, had a contig maximum length of 56,875 bp, and a contig N50 value of 610 bp. In both cases, the genome assembly is highly fragmented due to the lack of paired end data from inserts larger than 300 bp.

### Discussion

CONCO is the first integrated venomomics project, aiming at a global understanding and elucidation of the venomous function of a cone snail and with objectives to identify novel bioactive drug candidates. These preliminary studies revealed a few unexpected results that were overcome by in depth investigation of both a range of well established methods and sequencing exploiting the most recent technological developments. The first challenge related to compounds that were being co-extracted and co-purified together with genomic DNA when our standard protocols were used. This was overcome by exploring and identifying modifications to the protocol that resulted in isolated DNA with improved characteristics. The second challenge related to a structural particularism of the *C. consors* genome: a high content of long di-nucleotide repeats all along the genome. Different assays have been tested to overcome that problem that results in an impossibility of sequencing through fragments that contain such repeats. A similar situation has been observed in the case of the genome project of *Aplysia californica* (sea slug). The solution used for *Aplysia* was to perform the sequencing *via* the "classical Sanger approach". However, this is a time consuming and expensive technique. It has thus been decided to center the *C. consors* genome sequencing on the pyrosequencing approach together with the use of a Roche 454 Titanium machine and to combine the results obtained with other next generation sequencing techniques to facilitate the assembly and generate a high quality genome. Coupled to dedicated bioinformatic tools developed within the Consortium, we are confident that we can overcome the problems of di-nucleotide repeats.

**Acknowledgements.** *This study has been performed as part of the CONCO cone snail genome project for health (www.conco.eu) funded by the European Commission within the 6th Framework Program (LIFESCIHEALTH-6 Integrated Project LSHB-CT-2007, contract number 037592). We are most grateful to the French Institute of Research for the Development (IRD), and to the governments of New Caledonia and French Polynesia for their support. We also acknowledge Skuld-Tech for providing EST sequences to allow confirmation of our genome sequencing. We wish to thank Cindi Pfannkoch for her guidance for sample preparation and useful suggestions for DNA isolation and thank JCVI's Joint Technology Center for library construction and next generation sequencing.*

### References

- Blass D, Dutertre S, Gerbault A, Menou JL, Offord R, Favreau P, Stöcklin R (2009) Comparative proteomic study of the venom of the piscivorous cone snail *Conus consors*. *J Proteomics* **72**: 210-218
- Dutertre S, Blass D, Stöcklin R, Favreau P (2010) Dramatic intraspecimen variations within the injected venom of *Conus consors*: an unsuspected contribution to venom diversity. *Toxicon* **55**: 1453-1462
- Blass D, Dutertre S, Favreau P, Stöcklin R (2010) Rapid intraspecimen evolution of cone snail venom composition: multiplying pharmacological profiles ? In *Advances and new technologies in Toxinology*. Barbier J, Benoit E, Marchot P, Mattéi C and Servent D (eds) pp 175-176. SFET Editions, Gif sur Yvette, France, Epub on <http://www.sfet.asso.fr> (ISSN 1760-6004)
- Ménez A, Stöcklin R, Mebs D (2006) 'Venomics' or: The venomous systems genome project. Editorial. *Toxicon* **47**: 255-259
- Gross V, Carlson G, Kwan AT, Smejkal G, Freeman E, Ivanov AR, Lazarev A (2008) Tissue fractionation by hydrostatic pressure cycling technology: the unified sample preparation technique for systems biology studies. *J Biomol Tech* **19**: 189-199
- Sambrook J, Fritsch EF, Maniatis T (1989) *Molecular Cloning: A Laboratory Manual*. Ed. 2, Cold Spring Harbor Laboratory Press: Cold Spring Harbor, NY
- Margulies M, Egholm M, Altman WE, Attiya S, Bader JS, Bemben LA, Berka J, Braverman MS, Chen YJ, Chen Z, *et al* (2005) Genome sequencing in microfabricated high-density picolitre reactors. *Nature* **437**: 376-380
- Sanger F, Nicklen S, Coulson AR (1977) DNA sequencing with chain-terminating inhibitors. *Proc Natl Acad Sci* **74**: 5463-5467
- Bentley DR, Balasubramanian S, Swerdlow HP, Smith GP, Milton J, Brown CG, Hall KP, Evers DJ, Barnes CL, Bignell HR, *et al* (2008) Accurate whole human genome sequencing using reversible terminator chemistry. *Nature* **456**: 53-59
- Lodhi MA, Guang-Ning Y, Weeden NF, Reisch BI (1994) Simple and efficient method for DNA extraction from grapevine cultivars *Vitis* species *Ampelopsis*. *Plant Mol Biol Rep* **12**: 6-13
- Bernardi G (1965) Chromatography of nucleic acids on hydroxyapatite. *Nature* **206**: 779-783
- CLC Bio (2010) White paper on de novo assembly in CLC Assembly Cell 3.0. [http://www.clcbio.com/files/whitepapers/white\\_paper\\_on\\_de\\_novo\\_assembly\\_on\\_the\\_CLC\\_Assembly\\_Cell.pdf](http://www.clcbio.com/files/whitepapers/white_paper_on_de_novo_assembly_on_the_CLC_Assembly_Cell.pdf)
- Miller JR, Koren S, Sutton G (2010) Assembly algorithms for next-generation sequencing data. *Genomics* **95**: 315-327

## ***Animal toxin precursors : from individual cloning to global transcriptomic studies***

Frédéric DUCANCEL\*, Yves TERRAT

LIAS/SPI/IBiTec-Saclay/DSV/CEA, Bt. 152, CE de Saclay, F-91191 Gif sur Yvette cedex, France

\* Corresponding author ; Tel : +33 (0)1 6908 8154 ; Fax : +33 (0)1 6908 7091 ;  
E-mail : [frederic.ducancel@cea.fr](mailto:frederic.ducancel@cea.fr)

---

### **Abstract**

*Since the publication of the first article describing a precursor encoding an animal toxin in 1985, the strategies of cloning and studying precursors have regularly evolved. These evolutions are linked to the development of new formats of amplification (PCR) and to the possibility to design EST (Expressed Sequenced Tags) libraries. Furthermore, the recent transfer to transcriptomic of massive sequencing approaches initially used in genomic studies nowadays allows toxinologists to study the global transcriptional activity of the cells forming the venom glands.*

### ***Les précurseurs de toxines animales : du clonage individuel aux études globales de transcriptomique***

*Depuis la publication du premier article décrivant un précurseur codant une toxine animale en 1985, les stratégies de clonage et d'étude des précurseurs n'ont cessé d'évoluer. Ces évolutions sont liées au développement de nouvelles stratégies d'amplification (PCR), ou à la constitution de banques d'EST (Expressed Sequenced Tags). Qui plus est, le transfert récent en transcriptomique des stratégies de séquençage massif initialement utilisées dans les études génomiques, permet maintenant d'étudier l'activité transcriptionnelle globale des cellules constitutives d'une glande à venin.*

**Keywords** : Animal toxins, cDNA cloning, expressed sequenced tags (EST), precursors, pyrosequencing, transcriptomic.

---

## **Introduction**

Cloning and studying of protein and peptide precursors, and especially those encoding animal toxins, constitutes a major activity of researchers in toxinology. Initially, it was the method of choice to obtain the nucleic material encoding mature toxins necessary to their expression by recombinant technologies. Thus, in 1985, the group of Pr. T. Tamiya in Japan (Tamiya *et al.*, 1985) published and described the first precursor encoding an animal toxin, *i.e.* the three-fingered neurotoxin Erabutoxin a from *Laticauda semifasciata*. This pioneer work was conducted accordingly to the cloning strategy described by Okayama and Berg (1982). Following this first success, numerous laboratories have entered into the era of molecular biology and recombinant technologies applied to animal toxins. Thus, several hundreds of animal toxin precursors have been cloned and sequenced so far, among which numerous have been expressed in bacteria, yeast or eukaryotic cells, allowing toxinologists/biochemists to undergo structure-function relationships studies and engineering projects.

However, the methods to clone nucleic acids have continuously evolved during the last decades, providing the researchers with more simple and straightforward cloning strategies: availability of cloning kits, cloning by Reverse-Transcriptase PCR (RT-PCR), 5' and 3' RACE (Rapid Amplification of cDNA Extremities) and more recently the possibility to design EST (Expressed Sequenced Tags) libraries. If one adds the evolutions in the field of DNA sequencing that can be massive (pyrosequencing, Solexa/Illumina technology), researchers are now able to build and analyse, in few weeks, libraries of several thousands of precursors. Clearly, we are now entering into the era of massive transcriptomic studies. In combination with proteomic and genomic, massive transcriptomic permits to define exhaustive panoramas of the biological activities and relationships that characterize a cell-type or a tissue, such as the hyper-specialized venom glands.

## **Cloning of animal toxin precursors : starting material, interest and organization**

### **Starting material**

Classically, the cloning of an animal toxin precursor is performed from RNAs extracted from venom gland cells. Depending on the cloning strategy used, the mRNA fraction should be or not be further purified. Owing to their

fragility especially regarding RNase activities, mRNAs are quickly converted into double-stranded DNA forms prior to their cloning, amplification and sequencing. Almost all what is known on animal toxin precursors has been learned in following this "classical" procedure. However, it has been recently shown, by the group of Chris Shaw in Ireland, that it is also possible to clone animal toxin precursors directly from the milked venom (Chen *et al.*, 2002). This was demonstrated both for snakes and scorpions, a result showing that despite the unfavorable content in nucleases of venoms, nucleic acids are able to retain a functional molecular state in the venom. However, the meaning and "interest" for venomous animals to have messenger RNA in their venom is not understood.

### Interests to clone animal toxin precursors

Cloning of animal precursors can be associated to various topics:

- To study the structure and organization of animal toxin precursors,
- To identify new animal toxin isoforms,
- To get the nucleic material for expression of mature recombinant animal toxin,
- To explore the diversity of animal toxins: transcriptomic vs proteomic,
- To study the overall transcriptional activities of the venom apparatus,
- To annotate genomes regarding the venom gland machinery,
- To identify the genome dynamism (translocation, transposable elements, splicing events, RNA editing).

However, depending on one's objective of the project, the investigators have to choose the more appropriate cloning strategy among those mentioned above *i.e.* individual *versus* global precursor cloning.

### Organization of animal toxin precursors

Animal toxin precursors display diverse structures and organizations. Today, four main families of animal toxin precursors have been identified. The first one and most abundant corresponds to monomeric precursors (*Figure 7*), which means that each precursor encodes one mature toxin. This is the case for three-fingered toxins, most of the PLA<sub>2</sub>s, conotoxins or scorpion toxins. Following a quite short 5' non-coding region one finds a signal peptide directly followed by the mature toxin sequence or followed by an intermediate propeptide, and then the toxin sequence. In some cases the mature toxin sequence is surrounded by two propeptides, one before and one after. The 3' non-coding region that follows is, in general, composed of 100-200 base pairs containing the polyadenylation site and ending by a poly-(A<sup>+</sup>) sequence. The former is classically used to purify eukaryotic mRNAs before cloning.

*non-coding 5' extremity*

```

TCCGAAAAAGATCGCAAG ATG AAA ACT CTG CTG CTG ACC TTG GTG GTG GTG 51
      M K T L L L T L V V V
ACA ATC GTG TGC CTG GAC TTA GGA TAC ACC AGG ATA TGT TTT AAC CAT 99
  T I V C L D L G Y T R I C F N H
CAG TCA TCG CAA CCG CAA ACC ACT AAA ACT TGT TCA CCT GGG GAG AGC 147
 Q S S Q P Q T T K T C S P G E S
TCT TGC TAT AAC AAG CAA TGG AGC GAT TTC CGT GGA ACT ATA ATT GAA 195
 S C Y N K Q W S D F R G T I I E
AGG GGA TGT GGT TGC CCC ACA GTG AAG CCC GGT ATT AAA CTC AGT TGT 243
 R G C G C P T V K P G I K L S C
TGC GAA TCA GAG GTC TGC AAC AAT TAG CTCTACGAGTGGCTAAATTCCTTGAGT 297
 C E S E V C N N stop
TTTACTCTCATTTCATCAAGGACCATCCTTCAAATGTATGCTTCTGGCCCTTACCACCACATG 360
GTCCATCATCCCCCTCTCCCTGCTGTCTTTGACACCTCAACATCTTTCCCTTTTCTCTTGAT 423
CTGTAAAGTTTCCTTCGTCTAGTTCTGTAGTTTGAGATCAAAATAAACCTCAGCATTCAAAAAA 486
AAAAAAAAAAAAAAAAAAAAA non-coding 3' extremity 507

```

**Figure 1.** Precursor encoding Erabutoxin a (Ea) from *Laticauda semifasciata* (Tamiya *et al.*, 1985). The signal peptide is underlined. The poly-adenylation site is both underlined and italicized.

**Figure 1.** Précurseur codant l'Erabutoxine a (Ea) de *Laticauda semifasciata* (Tamiya *et al.*, 1985). Le peptide signal est souligné. Le site de poly-adénylation est souligné et en italique.

In the case of heterodimeric toxins there are two possibilities. The two chains are either encoded by distinct precursors, like in the case of crotoxin (Bouchier *et al.*, 1988), or they are on the same precursor, like in the case of phospholipin (Conde *et al.*, 1999).

Finally, poly-cistronic animal toxin precursors were recently identified by cloning. The first one to be identified encodes sarafotoxins that are endothelin-analogues found uniquely in the venom of the *Atractaspidae* species *Atractaspis engaddensis* (Ducancel *et al.*, 1993). Indeed one precursor molecule encodes 12 sarafotoxins corresponding to 5 different isoforms (a, a1, b, c and e). Anti-microbial peptides from the toad *Bombina maxima*, snake bradikinin-potentiating peptides and C-type natriuretic peptides from *Bothrops jararaca jararaca* and *Lachesis muta muta*, laticarins from *Lachesis tarabaei* spider and crab-neurotoxins from sea-anemone *Antheopsis maculata* are all encoded by poly-cistronic precursors. Surprisingly, sarafotoxins from *Atractaspis irregularis* are also expressed from monocistronic precursors (Quinton *et al.*, 2005), a unique situation for isopeptides.

## Cloning of animal toxin precursors : global approaches

### EST : a first step toward global transcriptomic studies

As a new approach to studying animal toxin precursors, the so-called ESTs (Expressed Sequenced Tags) strategy has appeared during the last decade. ESTs are short (200-500 nucleotides) cDNA sub-sequences corresponding to the one-shot-sequencing of the precursor 5' and/or 3' extremities of massively cloned reverse-transcribed messenger RNA library. Sequencing is then performed using the classical Sanger's method (1977). This cloning strategy provides researchers with a larger view of the transcriptional activity of a tissue, revealing in particular the genes mainly expressed by the cells at a particular time. It also allows the discovery of genes encoding new toxin scaffolds. To reduce the number of EST and to tentatively obtain the longest or complete precursor sequences, one can assemble EST into "contigs" using bio-informatics tools. Furthermore, ESTs constitute a convenient tool to annotate genome regarding peculiar tissue function. Thus, since 2003, several groups have successfully used the EST strategy to establish and study more globally the transcriptional activities of the venom gland cell, and this in almost all venomous animal phyla. For instance, in the case of conotoxins, the EST strategy allowed the authors to progress in the understanding of the molecular mechanisms responsible for conotoxin hypervariability (Conticello *et al.*, 2001), or to study the sequence diversity within a particular conopeptide superfamily (Luo *et al.*, 2007).

### Massive and global transcriptomic studies

During the five last years, the technological improvement about massive DNA sequencing has opened new perspectives in the field of global transcriptomic studies, especially those directed toward venomous apparatus. Up to now these new strategies of sequencing (Lamoril *et al.*, 2008), which include the pyrosequencing developed by Roche and the technology proposed by Solexa/Illumina, were used in genomics. When pyrosequencing generates several hundred of thousands of DNA fragments ranging from 200 to 300 bp in average, the Solexa/Illumina approach provides researchers with several millions of fragments of less than 100 bp. In both cases it is necessary to treat this huge amount of information bio-informatically using assembly algorithms to rebuild entire precursors. The so-called Contigs (since made of at least two DNA fragments) thus obtained are then annotated following research of identities or similarities in different databases.

## Conclusion

Clearly, we are now entering into a new era, that one of massive transcriptomic analyses. There is no doubt that the combination with proteomic studies and genomic programs should speed up the discovery of new compounds of therapeutic interest. Also, the global view provided about the molecular activities of the venom gland should help the researchers to progress towards the understanding of the molecular machinery that characterizes this hyper-specialized tissue.

## References

- Bouchier C, Ducancel F, Guignery-Frelat G, Bon C, Boulain JC, Ménez A (1988) Cloning and sequencing of cDNAs encoding the two subunits of Crotoxin. *Nucleic Acids Res* **16**: 9050
- Chen T, Bjourson AJ, Orr DF, Kwok H, Rao P, Ivanyi C, Shaw C (2002) Unmasking venom gland transcriptomes in reptile venoms. *Anal Chem* **311**: 152-156
- Conde R, Zamudio FZ, Becerril B, Possani LD (1999) Phospholipin, a novel heterodimeric phospholipase A2 from *Pandinus imperator* scorpion venom. *FEBS Lett* **460**: 447-450
- Conticello SG, Gilad Y, Avidan N, Ben-Asher E, Levy Z, Fainziber M (2001) Mechanisms for evolving hypervariability: the case of conopeptides. *Mol Biol Evol* **18**: 120-131
- Ducancel F, Matre V, Dupont C, Lajeunesse E, Wollberg Z, Bdolah A, Kochva E, Boulain JC, Ménez A (1993) Cloning and sequence analysis of cDNAs encoding precursors of sarafotoxins: evidence for an unusual "rosary-type" organization. *J Biol Chem* **268**: 909-916
- Lamoril J, Ameziane N, Deybach JC, Bouizegarène P, Bogard M (2008) DNA sequencing technologies: a revolution in motion. Part one. *Immuno-analyse et biologie spécialisée* **23**: 260-279
- Luo S, Zhangsun D, Feng J, Wu Y, Zhu X, Hu Y (2007) Diversity of the O-superfamily conotoxins from *Conus miles*. *J Pept Sci* **13**: 44-53
- Okayama H, Berg P (1982) High-efficiency cloning of full-length cDNA. *Mol Cell Biol* **2**: 161-170
- Quinton L, Le Caer JP, Phan G, Ligny-Lemaire C, Bourdais-Jomaron J, Ducancel F, Chamot-Rooke J (2005) Characterization of new toxins within crude venoms by combined use of Fourier Transform Mass spectrometry and cloning. *Anal Chem* **77**: 6630-6639
- Sanger F, Nicklen S, Coulson AR (1977) DNA sequencing with chain-terminating inhibitors. *Proc Natl Acad Sci USA* **74**: 5463-5467
- Tamiya T, Lamouroux A, Julien JF, Grima B, Mallet J, Fromageot P, Ménez A (1985) Cloning and sequencing analysis of the cDNA encoding a snake neurotoxin precursor. *Biochimie* **67**: 185-189

- Conde R, Zamudio FZ, Becerril B, Possani LD (1999) Phospholipin, a novel heterodimeric phospholipase A2 from *Pandinus imperator* scorpion venom. *FEBS Lett* **460**: 447-450
- Coticello SG, Gilad Y, Avidan N, Ben-Asher E, Levy Z, Fainziber M (2001) Mechanisms for evolving hypervariability: the case of conopeptides. *Mol Biol Evol* **18**: 120-131
- Ducancel F, Matre V, Dupont C, Lajeunesse E, Wollberg Z, Bdolah A, Kochva E, Boulain JC, Ménéz A (1993) Cloning and sequence analysis of cDNAs encoding precursors of sarafotoxins: evidence for an unusual "rosary-type" organization. *J Biol Chem* **268**: 909-916
- Lamoril J, Ameziane N, Deybach JC, Bouizegarène P, Bogard M (2008) DNA sequencing technologies: a revolution in motion. Part one. *Immuno-analyse et biologie spécialisée* **23**: 260-279
- Luo S, Zhangsun D, Feng J, Wu Y, Zhu X, Hu Y (2007) Diversity of the O-superfamily conotoxins from *Conus miles*. *J Pept Sci* **13**: 44-53
- Okayama H, Berg P (1982) High-efficiency cloning of full-length cDNA. *Mol Cell Biol* **2**: 161-170
- Quinton L, Le Caer JP, Phan G, Ligny-Lemaire C, Bourdais-Jomaron J, Ducancel F, Chamot-Rooke J (2005) Characterization of new toxins within crude venoms by combined use of Fourier Transform Mass spectrometry and cloning. *Anal Chem* **77**: 6630-6639
- Sanger F, Nicklen S, Coulson AR (1977) DNA sequencing with chain-terminating inhibitors. *Proc Natl Acad Sci USA* **74**: 5463-5467
- Tamiya T, Lamouroux A, Julien JF, Grima B, Mallet J, Fromageot P, Ménéz A (1985) Cloning and sequencing analysis of the cDNA encoding a snake neurotoxin precursor. *Biochimie* **67**: 185-189
-

## **Nano-liquid chromatography and mass spectrometry profiling of *Tityus serrulatus* scorpion venom**

Pierre E. BOUGIS<sup>1,2\*</sup>, Maya BELGHAZI<sup>2</sup>, Marie-France MARTIN-EAUCLAIRE<sup>1</sup>

<sup>1</sup> CNRS UMR6231, CRN2M, Université de la Méditerranée, Faculté de Médecine secteur Nord, CS80011, Bd Pierre Dramard, F-13344 Marseille cedex 15, France ; <sup>2</sup> CAPM, IFR11 Institut Jean Roche, Université de la Méditerranée, Faculté de Médecine secteur Nord, CS80011, Bd Pierre Dramard, F-13344 Marseille cedex 15, France

\* Corresponding author ; Tel : +33 (0)4 9169 8850 ; Fax : +33 (0)4 9169 8839 ;  
E-mail : pierre-edouard.bougis@univmed.fr

---

### **Abstract**

During the last decade, mass spectrometry (MS) has become one of the major suitable techniques for the analysis of peptide and protein components from animal venoms, not only for global mass mapping of these complex mixtures, or for structural studies on individual toxins. Here, we investigate toxic components from the scorpion *Tityus serrulatus* venom using the latest cutting edge advances in off-line LC/MALDI-TOF separation and peptide mass fingerprint. As a result, the nanogram range is perfectly achievable for the study of venoms.

### **Profilage du venin de *Tityus serrulatus* par nano-chromatographie en phase liquide et spectrométrie de masse**

Durant la dernière décennie, la spectrométrie de masse est devenue l'une des techniques appropriées majeures pour l'analyse des peptides et des protéines composant les venins animaux, non seulement pour une cartographie globale des masses de ces mélanges complexes, ou pour des études structurales sur des toxines individuelles. Ici, nous explorons les composés toxiques du venin du scorpion *Tityus serrulatus*, en utilisant les plus récentes avancées en « off-line » LC/MALDI-TOF séparation et empreinte peptidique massique. Ainsi, la gamme du nanogramme est parfaitement envisageable pour l'étude des venins.

**Keywords :** MALDI-TOF, nano-HPLC, scorpion, *Tityus serrulatus*, toxins.

---

## **Introduction**

Scorpion venoms constitute highly complex natural library of peptides, which display different kinds of pharmacological properties mostly targeting with high specificity ionic channels located in excitable cells, resulting in neurotoxic effects (Martin-Eauclaire and Couraud, 1995). As an example, toxins that modulate Na<sup>+</sup>, K<sup>+</sup>, Ca<sup>2+</sup> and Cl<sup>-</sup> currents have been described in scorpion venoms. Analytical methods such as gel electrophoresis, electrofocusing or liquid chromatography have already been classically used to establish several venom profiles. However, during the last decade, mass spectrometry (MS) was intensively and successfully used to analyze several *Buthidae* venoms. In particular, using matrix-assisted laser desorption/ionization time-of-flight (MALDI-TOF) MS, on-line liquid chromatography/electrospray mass spectrometry (LC/ES) MS and off-line LC/MALDI-TOF MS, our team was the first to decrypt the peptide mass fingerprints of the toxic fractions from the Brazilian scorpion *Tityus serrulatus*, the most clinically important scorpion family in South America (Pimenta *et al.*, 2001). At least 380 compounds were detected in the toxic fractions investigated. As *Tityus serrulatus* is a parthenogenetic species, sexual variations and intra-specific variations are naturally excluded. The sensitivity, accuracy, resolving power and rapidity of MS make now this method inescapable. Here, using the latest cutting edge advances in the field of nano-HPLC coupled to MS, we have reexamined the *Tityus serrulatus* venom content.

## **Materials and methods**

The venom obtained from *Tityus serrulatus* specimens collected in Belo Horizonte, Brazil, was first subjected to gel filtration to separate its components according to their molecular size. The resultant fractions II and III (FII and FIII), which account for 90 and 10% respectively of the whole venom toxic effect, were previously analyzed (Pimenta *et al.*, 2001). The most complex FIII only contains masses up to 5 000 Da, which mainly correspond to short-chain K<sup>+</sup> channels blockers but also to other unknown peptides. FIII was used all across the present study.

Nano-Liquid chromatography (nano-HPLC) analyses were performed by using a Dionex UltiMate® 3000

RSLCnano system controlled by CHROMELEON®. Elution profile was monitored by absorbance readings at 214 nm. HPLC grade elution solvents were water plus 0.05% TFA (A) and 80/20 % acetonitrile/water plus 0.04% TFA (B). Pre-column (200  $\mu\text{m}$  x 5 mm) and column (100  $\mu\text{m}$  x 250 mm) were PepSwift Monolithic Nano PS-DVB from Dionex. Running flow rate was set up at 1  $\mu\text{L}/\text{min}$ , column pressure was 400 bars, and temperature was 60 °C.

Matrix-assisted laser desorption/ionization time-of-flight (MALDI-TOF) analyses were performed on positive linear mode ( $m/z$  range: 800 to 6000) on a Bruker Ultraflex II TOF/TOF using flexControl and flexAnalysis 2.4. For 3D analysis WARP-LC 1.0 was used. Direct on-line spotting of the column effluent on a Bruker MTP 384 polished steel plate was performed using a LC Packing Probot and  $\mu\text{Carrier}$  2.0. The sampling rate was 3 spots by min with addition of 0.5  $\mu\text{L}$  of a filtered and twice-diluted saturated  $\alpha$ -cyano-4-hydroxycinnamic acid solution in 50/50% acetonitrile/water plus 0.1% TFA. MALDI-TOF spectra were automatically recorded with Autoexecute and were the average of 500 laser shots across each spot. Laser intensity varied from 40 to 80% at 200 Hz. External multipoint calibrations were made using peptide calibration standard II from Bruker.

## Results

The fraction FIII has been chosen in this study to test the limiting possibility of the nano-HPLC and spotting system in term of quantity of peptide material to be ideally injected. This fraction is the most complex one, compared to the FII. Indeed, our previous off-line LC/MALDI-TOF peptide mass fingerprinting study revealed 326 individual molecular masses spanning from  $m/z$  2500 to 5000 (see Table 2 in Pimenta *et al.*, 2001). In this study, three nano-HPLC runs were performed using respectively 550, 55, and 5 ng of material, compared to the 550  $\mu\text{g}$  used previously (*i.e.* a dynamic range of  $10^5$ ). Comparing the UV traces obtained, the first run was close to the column saturation and was not processed further. The two other run were automatically scanned for their peptide mass contents (Figure 1). Data were filtered for doubly-charged and dimer ions (rare species due to laser optimization). In the case of the 55 ng run the minimum peak intensity was set up at 100 and the maximum 60 000 (arbitrary unit). The total number of detected masses was 395. Among them, 244 had an intensity less than 1 000 and 151 were over this threshold value (*i.e.* the most intense).

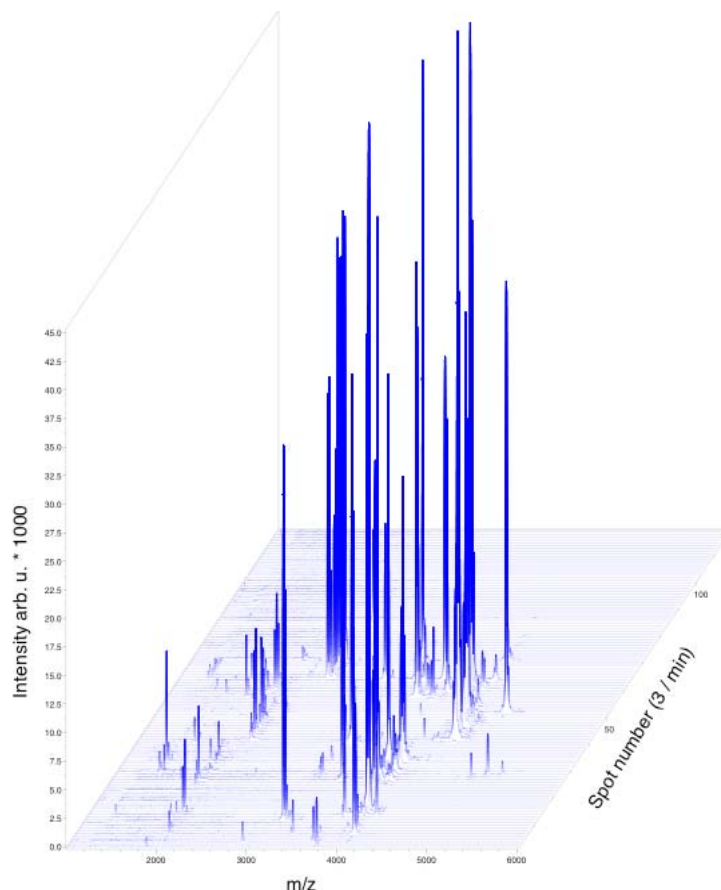

**Figure 1.** 3D drawing of the MALDI-TOF spectra ( $m/z$  vs Intensity) recorded on spots obtained from the nano-HPLC of the *Tityus serrulatus* FIII (55 ng). The chromatography duration was 40 min (120 spots) and the gradient from 4 to 40% of B in A.

**Figure 1.** Représentation 3D des spectres MALDI-TOF ( $m/z$  vs Intensité) des spots obtenus à partir de la nano-HPLC de la fraction FIII de *Tityus serrulatus* (55 ng). La durée de la chromatographie était de 40 min (120 spots) et le gradient de 4 à 40% de B dans A.

As a result, we have been able to detect up to 20% more peptide masses compared to our initial study (Pimenta *et al.*, 2001). Concerning the 5 ng run the noise/signal ratio increased as expected. However, all the more intense masses were easily detected. Furthermore, the 7 already known toxins (from amino acid and/or cDNA sequence) were still clearly identified. Moreover, it is noticeable that the set of data was obtained using a much shorter chromatographic time (40 instead of 100 min).

## Conclusion

The short present study shows that the recent developments in nano-HPLC and mass spectrometry allow us to obtain in an easy and almost automated way the profiling of the content of venoms, especially those obtained in tiny quantities (monogram range), even from individual species. Obviously, this possibility does not allow to go deeply further in the pharmacological deciphering of a venom. Some clues can be drawn from the lists of masses obtained ( $K^+$  versus  $Na^+$  channel toxins). Furthermore, if coupled to DNA sequence information's from the venomous apparatus (high-throughput sequence tags) the deciphering must be more straightforward.

## References

- Martin-Eauclaire MF, Couraud F (1995) Scorpion neurotoxins: Effects and mechanisms. In *Handbook of Neurotoxicology*, Chang LW, Dyer RS (eds) pp 683–716. New York: Marcel Dekker
- Pimenta AM, Stöcklin R, Favreau P, Bougis PE, Martin-Eauclaire MF (2001) Moving pieces in a proteomic puzzle: mass fingerprinting of toxic fractions from the venom of *Tityus serrulatus* (Scorpiones, Buthidae). *Rapid Commun Mass Spectrom* **15**: 1562-1572
-





## **Mass spectrometric sequencing of peptidic toxins : an overview**

Loïc QUINTON<sup>1\*</sup>, Julien ECHTERBILLE<sup>1</sup>, Pierre ESCOUBAS<sup>2</sup>, Nicolas GILLES<sup>3</sup>,  
Edwin DE PAUW<sup>1</sup>

<sup>1</sup> Laboratoire de Spectrométrie de masse-GIGA-R, Département de Chimie, B6c, Université de Liège, B-4000 Liège, Belgique ; <sup>2</sup> VenomeTech, 473 route des Dolines, Villa 3, F-06560 Valbonne, France ; <sup>3</sup> iBiTec-S, CEA de Saclay, F-91191 Gif sur Yvette, France

\* Corresponding author ; Tel : +32-4 366 3382 ; Fax : +32-4 366 3413 ; E-mail : [loic.quinton@ulg.ac.be](mailto:loic.quinton@ulg.ac.be)

---

### **Abstract**

*Venoms represent an immense and mostly untapped source of bioactive compounds. In spite of their amazing selectivity and affinity for their biological targets, less than 0.1% of the total number of peptide toxins has been characterized so far. Further development of mass spectrometry-based peptide sequencing technologies that will permit the generation of full sequences from even smaller venom amounts is of prime interest to toxinology studies. This article aims at reviewing some of the different de novo peptide sequencing approaches by mass spectrometry and their application to animal venom peptides.*

### **Séquençage de toxines peptidiques par spectrométrie de masse**

*Les venins animaux constituent une source immense et peu exploitée de peptides bioactifs. En dépit de leurs remarquables propriétés de sélectivité et d'affinité pour leurs cibles biologiques, moins de 0,1% du nombre total estimé de toxines peptidiques est caractérisé. Le développement de techniques de séquençage permettant d'accéder rapidement aux séquences complètes de ces mini protéines, en utilisant toujours moins de venin brut, est de toute première importance. Cet article propose une description des différentes méthodologies de séquençage de toxines peptidiques par spectrométrie de masse et de leur application aux composants peptidiques des venins animaux.*

**Keywords** : Mass spectrometry, sequencing, toxin.

---

## **Introduction**

More than 50.000 venomous animal species are currently indexed. Animal venoms are complex mixtures comprising up to one thousand components, many of them peptidic in nature. Many of the peptide toxins studied to date demonstrate high affinities for cellular receptors such as several types of enzymes, ion channels or G-Protein Coupled Receptors, as well as remarkable selectivity for the various receptor subtypes. Over the last 50 years, these features have been exploited to identify, purify and classify membrane receptors, to make use of peptide toxins as research tools and to conduct numerous structure/function studies. Due to their specific pharmacological properties, a number of animal toxins have served as drug templates, have entered the drug development pipeline and clinical studies, and some have reached commercial drug status. (Becker and Terlau, 2008; Escoubas and King, 2009; Lewis and Garcia, 2003; Shen *et al.*, 2000).

One major difficulty in toxinology lies in the structural characterization of the bioactive peptides. Indeed, most toxins are structured by several disulfide bonds and adopt a fairly constrained tridimensional structure, leading to their high affinity and high specificity properties, as the disulfide-stabilized protein scaffold is used to present a bioactive surface termed "pharmacophore". Disulfide bridges also increase resistance to proteolytic degradation.

Although Edman degradation is still used for the determination of most toxin sequences, mass spectrometry (MS) is increasingly seen as a viable alternative technique for that purpose, owing to its remarkable sensitivity and efficacy and the development of new instruments with advanced fragmentation capabilities. Since the emergence of soft ionization techniques such as electrospray ionization (ESI) (Fenn *et al.*, 1989) and matrix-assisted laser desorption-ionization (MALDI) (Karas and Hillenkamp, 1988), the use of mass spectrometry has moved well beyond the organic chemistry lab and has now a major role in the study of biomolecules. Mass spectrometry techniques have found many applications in toxinology, that include venom profiling, taxonomic and pharmacological classification of venoms, characterization of post-translational modifications as well as peptide toxin sequencing (Escoubas *et al.*, 2008). Hyphenated with liquid chromatography or SDS-PAGE, MS has been extensively used to profile whole venoms or to study changes in venom composition between animals with different diets, sexes and ecology. As an example, venom complexity traditionally estimated to involve

100-300 peptides per venom, was shown to be much more important after LC-MS studies (Escoubas *et al.*, 2006). LC-MALDI analysis of female *Atrax robustus* and *Hadronyche versuta* venoms, demonstrated that up to 1000 masses can be detected in a single spider venom. This complexity was also illustrated by LC-MS studies of cone snail venoms (Davis *et al.*, 2009), scorpions (Nascimento *et al.*, 2006) and snakes (Stocklin *et al.*, 2000). Other venom proteomics studies have also highlighted the impact of the evolutionary process on venom composition and the usefulness of venom proteomics for taxonomic and phylogenetic studies (Calvete *et al.*, 2007; Escoubas *et al.*, 1997).

Regarding *de novo* peptide sequencing by mass spectrometry, the strategy used strongly depends on parameters such as toxin mass range, the nature of PTMs and the amounts of toxin available. An additional difficulty lies in the absence of DNA sequence databases for the large majority of species of interest. This fact precludes a "classical" proteomics approach in which partial sequence tags or even uninterpreted peptide fragmentation spectra can be used to identify a protein and therefore obtain its full sequence from a database. The necessity of generating full sequence data from very small amounts of material imposes the use of either genomic / transcriptomic analysis if tissue cDNA/mRNA is available or a mass-spectrometry based approach when venom is analyzed. When the two types of samples are accessible, combining both methodologies is actually the ideal situation to decipher the complexity of a given venom. However, many post-translational modifications have been described in spider and cone snail toxins and can be studied only by mass spectrometry as this information cannot be obtained from transcriptomics data. For example,  $\epsilon$ -TxVA from the venom of *Conus textile* has a molecular mass of 1929.4 Da and is modified with two disulfide bonds, two  $\gamma$ -carboxyglutamic acids, one tryptophan bromination, one glycosylation and one hydroxyproline (Rigby *et al.*, 1999). Out of thirteen amino acids, nine are thus modified ! Such modifications strongly increase the difficulty to sequence toxins with usual physico-chemical techniques, and mass spectrometry can then help in characterizing modifications, using for instance fragmentation techniques to yield signal ions specific of each modification.

When mass spectrometry is the method of choice for characterization of unknown toxin sequences from venoms, two approaches are commonly employed. The first one is called "Bottom-Up sequencing" and has been mostly applied to proteins and peptides of mass  $M > 4,000$  Da. The strategy involves purification of the toxin, followed by reduction and alkylation of disulfide bonds and proteolytic digestion. The mixture of proteolytic peptides is then analyzed by MS and hyphenated MS/MS techniques (*see Part 1*) to obtain sequence information on protein fragments. The second approach, called "Top-Down sequencing", has been validated on a limited set of large proteins ( $> 10$  kDa) but has also been consistently applied to smaller peptide toxins ( $M < 4,000$  Da) and in some instances on toxins with masses up to 8,000 Da. It involves fragmentation of the entire protein in the gas phase without prior enzymatic digestion (*see Part 2*). The sequence is inferred from fragmentation spectra generated from the whole protein sequence. In both approaches, different mass spectrometry fragmentation techniques can be employed, leading to complementary information.

### "Bottom-up" sequencing of peptide toxins

"Bottom-Up" is the most common approach in proteomics studies (Aebersold and Mann, 2003) for the identification of proteins from databases. Proteins are digested with a proteolytic enzyme, and the resulting peptides are fragmented by MS/MS to generate "sequence tags" used in database searches.

In venom studies, peptide toxins are purified by HPLC or SDS-PAGE, and disulfide bonds are chemically reduced by agents such as dithiothreitol (DTT) or tris(carboxyethyl)phosphine (TCEP) in order to unfold the toxin and to improve digestion efficiency. As the reduction of each disulfide results in a mass increase of 2 Da, the comparison between the masses measured before and after reduction permits the determination of the number of disulfide bridges initially present in the toxin. In some cases, for example with conotoxins where many different structural folds are known and correlated with specific pharmacological activity, this can point to certain classes of peptides and guide the functional investigation of the toxins.

Free cysteines are then alkylated by agents such as iodoacetamide to prevent oxidation of the thiols and disulfide bridge formation. Reduced and alkylated peptides are digested by an endopeptidase such as trypsin to generate a set of digestion peptides, generally in a mass range  $< 3,500$  Da, that are characteristic of the initial toxin sequence.

Proteolytic peptide mixtures can then be analyzed by mass spectrometry (MALDI-TOF, ESI-Q-TOF, ESI-IT) to generate a specific "peptide mass fingerprint" (PMF). As an example, *Figure 1* displays the PMF obtained by MALDI-TOF for the toxin  $\rho$ -Da1b (MW= 7507.5 Da, 4 disulfide bridges, 66 amino acids) found in the venom of *Dendroaspis angusticeps* (Rouget *et al.*, 2010). The spectrum displays intense peptide signals for which masses can be attributed to theoretical  $\rho$ -Da1b tryptic peptides. In this example, 100% coverage of the toxin sequence was obtained, a rather uncommon occurrence in such studies. Generating the PMF for a toxin can for example permit validation of sequencing data generated by Edman degradation, especially for sequences obtained from small amounts of digestion peptides, often difficult to interpret in Edman degradation experiments. Careful comparison of theoretical and measured peptide masses from digests can also indicate the presence of isoforms or PTMs when mass discrepancies are observed.

In "classical" proteomics experiments, the interrogation of DNA and protein databases with MS data leads to the full protein sequence even from only a few sequence tags. However, only a few venomous animal genomes are available (*e.g. Apis mellifera, Nasonia vitripennis, Hydra magnipapillata, Nematostella vectensis*), and only 1500 toxins have been fully sequenced so far. The full characterization of novel peptide toxin sequences has thus to be done by full, *de novo* sequencing of peptides by mass spectrometry. This is often achieved by tandem mass spectrometry that allows the isolation and fragmentation of each peptide in the gas-phase (Slenn and Volmer, 2004).

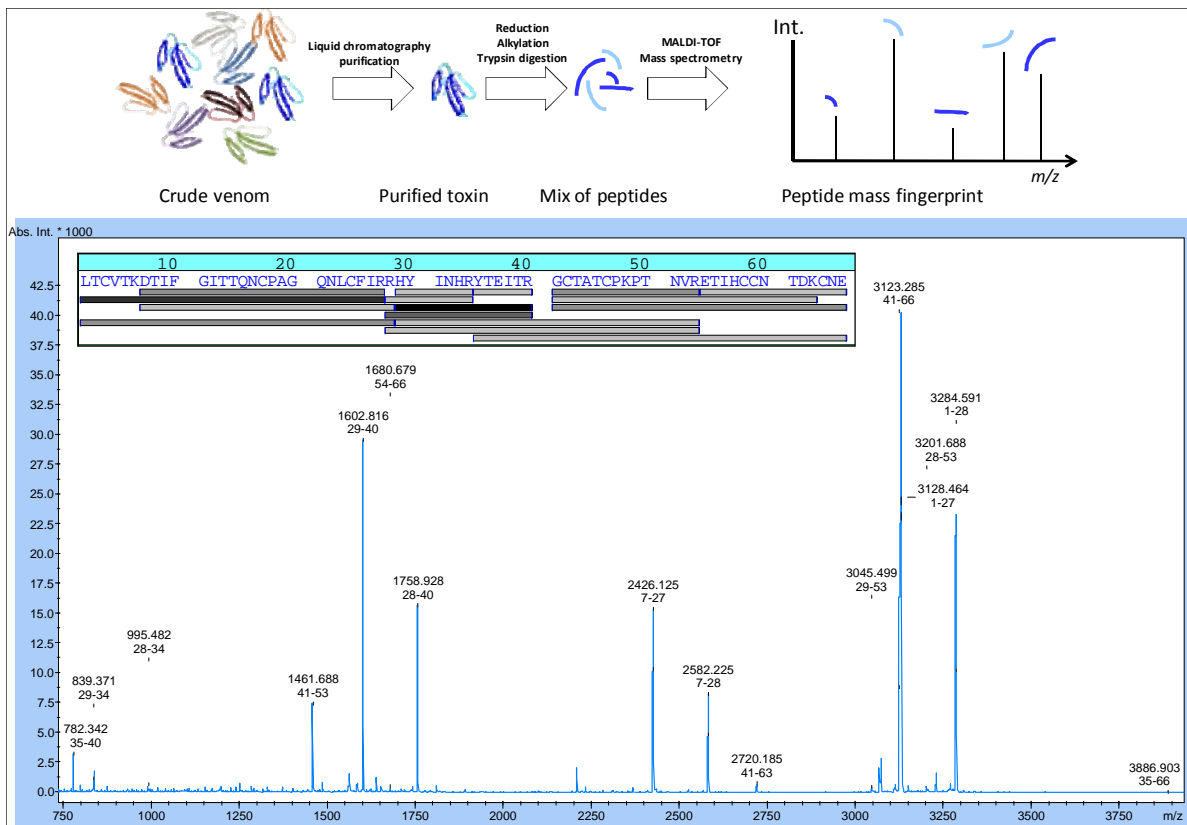

**Figure 1.** Peptide mass fingerprint obtained for the toxin  $\rho$ -Da1b from *Dendroaspis angusticeps* venom. After being reduced, alkylated and digested by trypsin,  $\rho$ -Da1b was analyzed by MALDI-TOF mass spectrometry (matrix: 2,5-DHB). The  $m/z$  ratio corresponding to the  $[M+H]^+$  species and the peptide position within the full sequence are indicated above each peak. The insert displays the sequence alignment of  $\rho$ -Da1b and the peptides detected showing that 100% of the sequence are identified.

**Figure 1.** Carte peptidique de la toxine  $\rho$ -Da1b découverte dans le venin de *Dendroaspis angusticeps*. Après réduction, alkylation et digestion par la trypsine,  $\rho$ -Da1b a été analysé par spectrométrie de masse MALDI-TOF (matrice: 2,5-DHB). Au dessus de chaque pic est indiqué le rapport  $m/z$  de chaque espèce et la position du peptide dans la séquence. L'insert montre l'alignement de la séquence de la toxine avec les peptides détectés, démontrant que 100% de la séquence sont identifiés.

Two types of fragmentation techniques are mainly used. Collision induced dissociation (CID) dissociates peptide ions by collision with an inert gas such as  $N_2$ . Each collision slowly increases the internal energy of the peptide up to the fragmentation threshold of the lowest energy bonds. If the peptide does not contain labile post-translational modifications such as glycosylation or phosphorylation, the peptidic bond is preferentially broken leading to  $y$ - and  $b$ - type ions according to the Roepstorff and Biemann nomenclature (Figure 2; Roepstorff and Fohlman, 1984; Johnson *et al.*, 1987). In bottom-up experiments, proteolytic peptides are analyzed and due to the use of trypsin, the majority of the peptides generated possess a basic C-terminal residue (arginine or lysine), which results in the formation of intense  $y$ -type ion series allowing for easier interpretation of fragmentation spectra. A CID-like technique called "post-source decay" (PSD) is employed in certain MALDI-TOF/TOF mass spectrometers (Spengler *et al.*, 1991). Fragmentation efficiency and nature of the fragments are however, quite the same.

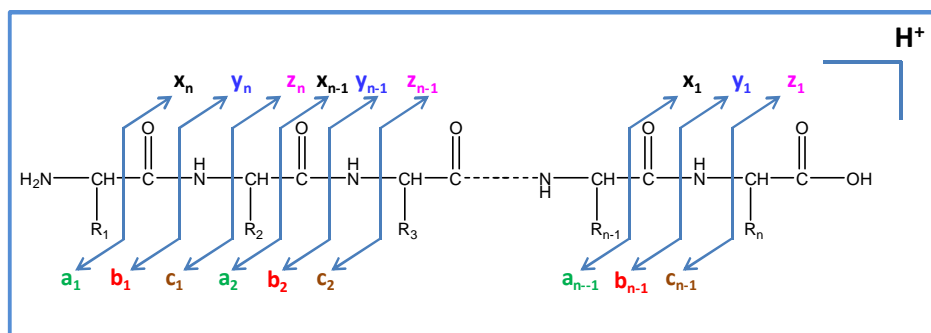

**Figure 2.** Nomenclature of common ion types.

**Figure 2.** Nomenclature des fragments ioniques les plus couramment rencontrés.

One difficulty of this approach concerns the attribution of isobaric amino acids such as leucine and isoleucine, quasi-isobaric ions such as glutamine and lysine, hydroxyproline and isoleucine/leucine, valine-valine and proline-threonine ( $\Delta M = 36$  mDa) or molecular species of identical elementary composition such as glycine-glycine and asparagine ( $C_4H_6N_2O_2$ , 114.0429 Da). Concerning isobaric amino acids, mass spectrometry does not represent the most powerful technique even if high-energy CID (Mandal *et al.*, 2007) and "hot-electron capture dissociation" (Kjeldsen *et al.*, 2003) experiments have been used to discriminate leucine and isoleucine amino acids. Transcriptomics or Edman degradation data are often needed to clarify these ambiguities. On the other hand, the distinction between quasi-isobaric amino acids is directly linked to resolution and accuracy of the mass spectrometer. Therefore, the newest generation of MALDI-TOF, Q-TOF and FI-ICR mass spectrometers are able to easily discriminate ions with 36 mDa mass differences, leading to unambiguous amino acid identification.

Figure 3 displays the MS/MS spectrum acquired for the peptide detected at  $m/z$  2426.1 in the  $\rho$ -Da1b PMF (Figure 1). As expected, a large series of  $y$ -ions is detected. Above  $m/z$  800, only  $y$ -type ions are detected, allowing rapid and confident sequence interpretation for a large part of the peptide, by calculating the mass difference between two consecutive ions in the series. Below this mass, many other ion types are detected such as  $b$ -ions, internal fragment ions and immonium ions. This abundance of signals does not allow precise sequence determination using the same methodology as the overlap of non-relevant masses with those of  $y$ -ions leads to potential mistakes. To confirm the full sequence, unsequenced peptides can be analyzed and sequenced using another fragmentation process (see below). Figure 3 shows the different ions which have been used to sequence such a peptide. Two of them, characterizing the dipeptide "proline/alanine", are missing due to the fact that fragmentation on the  $C$ -terminus side of prolines is often undetectable (absence of  $y_9$  and  $b_{12}$ ) whereas fragmentation on the  $N$ -terminus side is often facilitated (Breci *et al.*, 2003)

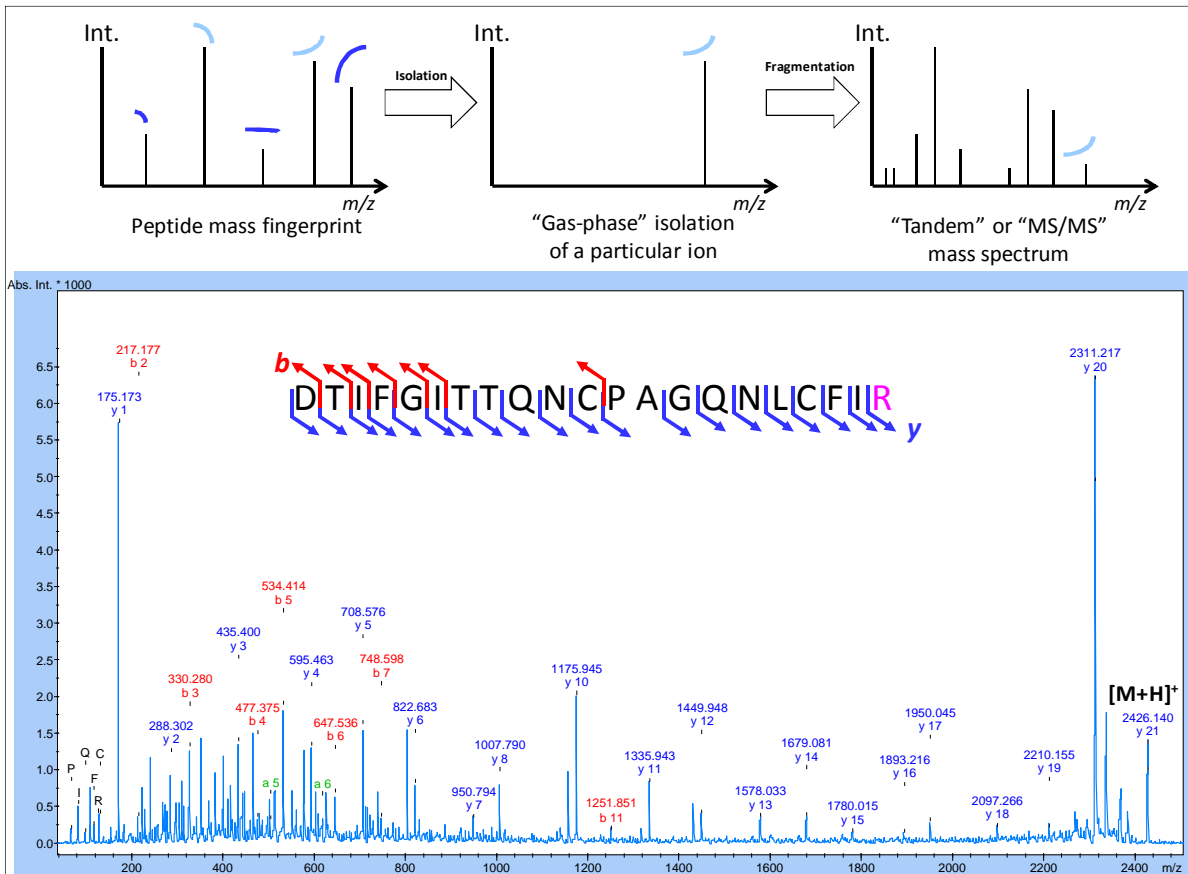

Figure 3. Tandem mass spectrum (MS/MS) obtained by MALDI-TOF/TOF for peptide  $\rho$ -Da1b detected at  $m/z$  2426.1 – The  $y$ -ion and  $b$ -ions detected for the different peptides allow, in combination with Edman degradation results, the sequencing of the whole toxin (MW=7507.5 Da). Spectrometer: Ultraflex II (Bruker Daltonics), matrix: 2,4-dihydroxybenzoic acid, reflectron mode.

Figure 3. Spectre de masse en tandem (MS/MS) obtenu par MALDI-TOF/TOF pour le peptide de  $\rho$ -Da1b détecté à  $m/z$  2426.1 – Les ions  $y$  et  $b$  détectés pour les différents peptides ont permis, avec l'aide de résultats de la dégradation d'Edman, d'obtenir la séquence complète de cette toxine ( $M = 7507,5$  Da). Spectromètre : Ultraflex II (Bruker Daltonics), matrice: acide 2,4-dihydroxybenzoïque, mode réflectron.

Other efficient fragmentation techniques are based on gas-phase electron chemistry. This is the case in electron capture dissociation (ECD; Zubarev, 2004) and electron transfer dissociation (ETD; Syka *et al.*, 2004).

The process rests on the capture of an electron by a multiprotonated peptide generated by electrospray. The electron capture results in a reactive radical species which dissociates into *c*- and *z*-ion types following the break of N-C<sub>α</sub> bonds (Figure 2). Interestingly, ECD and ETD do not preferentially fragment the lowest energy bonds. As modified amino acids also conserve their modifications during the fragmentation process, these technologies are useful in the identification and localization of PTMs (Mirgorodskaya *et al.*, 1999).

However, the "Bottom-up" strategy suffers from several limitations. First, a peptide toxin has to be fully purified prior to reduction/alkylation and digestion, in order to generate unambiguous results. Second, it is sometimes difficult to determine the full amino acid sequence of an unknown toxin due to the loss of proteolytic peptides during sample preparation, incomplete or partial digestion, poor ionization, lack of lysine or arginine residues in portions of the sequence leading to very long peptides, etc. Third, MS/MS spectra do not always allow the unambiguous determination of an amino acid sequence as some ions may be missing in a given series, owing to low fragmentation efficiency. Finally, a single PMF followed by MS/MS experiments is usually not sufficient to reconstruct the sequence of an unknown toxin. Even if all the MS/MS spectra lead to unambiguous sequences of individual peptides, it may not be possible to link these peptides in the right order if there is insufficient overlap. In such cases, lower digestion efficiency may actually be an advantage as overlapping sequences will be generated by missed cleavages. Usually, the problem is solved by the use of at least two proteolytic enzymes with different cleavage specificities, such as trypsin and chymotrypsin, or trypsin and V8 protease, etc.

Some complementary information that will help in full sequence determination may also be obtained from protein or genomic databases if homologous toxins have previously been isolated for the same species or closely related species. Comparing theoretical masses with measured ones, and using protein analysis software to predict mutations and their impact on mass changes can lead to working hypotheses, and guide further MS experiments for confirmation. Such a strategy has been used in the study of snake neurotoxins (Escoubas, unpublished data).

### "Top-Down" sequencing of peptide toxins

"Top-Down" sequencing (TDS) is based on the fragmentation of the entire protein or peptide, *i.e.* without any enzymatic digestion (Kelleher, 2004). The main interest of this technique is that the full sequence is available for fragmentation without the need for sample preparation steps that may lead to peptide losses.

TDS of peptide toxins can be performed by different techniques. "Top-Down" using CID is mainly used for toxins with small masses. After a reduction step (and possibly alkylation), the toxin is directly fragmented in the gas-phase. The mass range suitable to the technique is limited to ~4kDa in MALDI-TOF mass spectrometry as the energy deposited by the multiple collisions does not sufficiently increase the peptide internal energy to induce fragmentation. However, many conotoxins have masses below 4kDa and are therefore amenable to that fragmentation approach.

Several examples of "Top-Down" sequencing of peptide toxins by CID are described in the literature. Examples include high-throughput PTM analysis of *Conus victoriae* venom toxins after a full venom reduction/alkylation (Jakubowski and Sweedler, 2004) or the sequencing of novel conotoxins directly from crude *Conus virgo* venom by high-resolution mass spectrometry (Quinton *et al.*, 2006). Conotoxins are not the only peptide family that can be directly sequenced by this technique. Small peptides from snake venom such as the sarafotoxins (Hayashi *et al.*, 2004; Quinton *et al.*, 2005), the bradykinin-potentiating peptides (Soares *et al.*, 2005) or the short peptides containing poly-His and poly-Gly segments (Favreau *et al.*, 2007), were also characterized using *de novo* top-down sequencing.

Figure 4 shows the MS/MS spectrum obtained for M-conotoxin Tx3.5a (M=1889.7 Da) from *Conus textile* venom. It displays a large series of *a*-, *b*- and *y*-ions which allow the characterization of a large portion of the conotoxin sequence. In Top-Down experiments, no basic amino acids are expected at the protein *C-terminus* explaining why the spectrum contains a more or less complex mixture of *b*- and *y*-ions. Interestingly, the intensity of the fragments highlights again the fact that *C-terminus* fragmentation of prolines is difficult to observe (*y*<sub>8</sub>, *y*<sub>11</sub>, *b*<sub>6</sub> and *b*<sub>8</sub> are missing).

The spectrum of Tx3.5a is particularly easy to interpret since fragment ions are intense and numerous. Unfortunately, this is not the case for the majority of MS/MS spectra acquired for toxins. Many of them display incomplete series of fragment ions which do not allow for full peptide sequencing in a single experiment.

Complementary techniques have therefore to be used in order to generate the missing sequence information. One approach lies in combining information from two different fragmentation techniques. The power of collision-induced dissociation combined with *in-source decay* (ISD) by MALDI, has already been demonstrated in the analysis of conotoxins (Quinton *et al.*, 2007). MALDI-ISD is a fast fragmentation process that occurs within the MALDI source (Hardouin, 2007). It is initiated either by collisions leading mainly to the generation of *y*-type ions or by the release of radical hydrogen from the matrix, generating *c*- and *z*-ions. Each mechanism can be facilitated according to the matrix properties (Demeure *et al.*, 2007).

Another elegant approach has been successfully developed for the analysis of conotoxins (Ueberheide *et al.*, 2009). Assuming that conotoxins possess a high cysteine content, the strategy applied was to increase the toxin charge state by modifying cysteine residues with N,N-dimethyl-2-chloro-ethylamine. The charge state increase led to a remarkable enhancement of ETD fragmentation. In that particular study, the combination of classical CID, ETD and ETD including chemical modification permitted the unambiguous sequencing of 31 peptides from the venom of *Conus textile*.

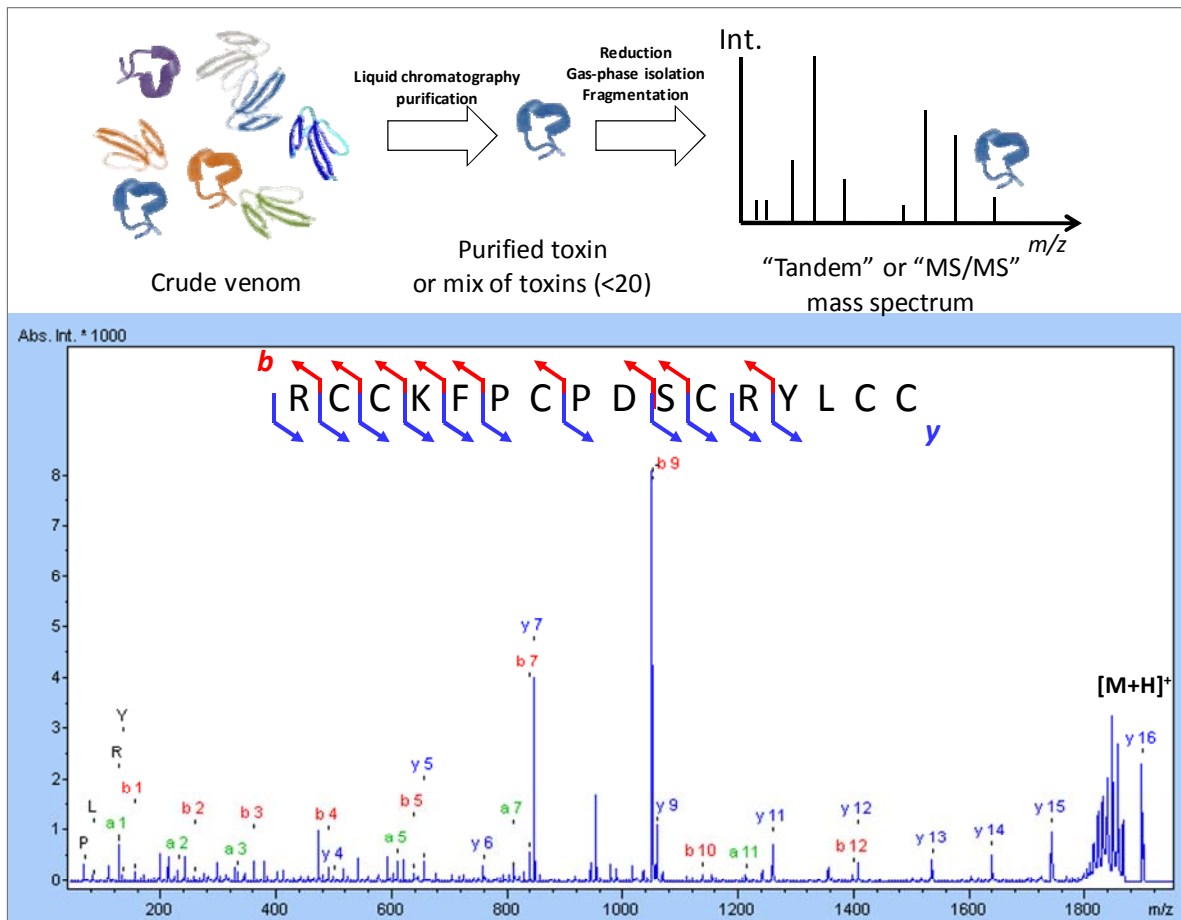

**Figure 4.** MS/MS spectrum of Tx3.5a, a conotoxin from the venom of *Conus textile*. After a simple reduction, the toxin was fragmented using a MALDI-TOF/TOF mass spectrometer [Spectrometer: Ultraflex II (Bruker Daltonics), matrix: 2,5-DHB, reflectron mode]. The full sequence of the toxin was obtained with the help of the precursor sequence found in database (Expasy accession number: POC1N7).

**Figure 4.** Spectre MS/MS obtenu pour la toxine Tx3.5a, une conotoxine découverte dans le venin du cône textile. Après avoir réduit les ponts disulfures, la toxine a été fragmentée par MALDI-TOF/TOF [Spectromètre: Ultraflex II (Bruker Daltonics), matrice: 2,5-DHB, mode reflectron]. La séquence complète de la toxine a été obtenue avec l'aide de la séquence du précurseur présent dans les bases de données (code d'accès dans Expasy : POC1N7).

"Top-Down" sequencing can also be performed on toxins of higher mass (> 4kDa) using electron capture dissociation or electron transfer dissociation with ESI sources, or in-source decay with MALDI sources. ECD or ETD experiments allow the selection of the ion of interest before the fragmentation process but the resulting spectra can be very complex due to the generation and fragmentation of multiply charged ions. Conversely, MALDI-ISD does not permit the selection of a particular parent ion but ISD spectra comprise only singly charged ions, and are therefore easier to analyze.

Figure 5 shows a MALDI-ISD spectrum acquired for reduced TA2 (M=6593.1, 4 disulfide bridges, 60 amino acids) from *Dendroaspis angusticeps* venom. The matrix 1,5-diaminonaphthalene used in the experiment, has been shown to increase ISD ion yield when compared to 2,5-DHB, the MALDI matrix classically used for ISD (Demeure *et al.*, 2007; Fukuyama *et al.*, 2006). The spectrum shows a very large *c*-ions series from  $c_9$  to  $c_{58}$ , that permitted the assignment of 49 amino acids out of 60 (81.7% sequence coverage). However, two types of *c*-ions are missing. First, the lack of  $c_{10}$ ,  $c_{30}$  and  $c_{41}$  ions is explained by the presence of proline residues. Since MALDI-ISD results in the fragmentation of the N- $C_\alpha$  bonds, no *c*-fragment ion can be generated due to the cyclic character of proline. As this observation is very general, a gap in a *c*-ion series from an ISD-sequencing experiment can possibly be interpreted as showing the presence of a proline residue on the N-terminal side of the peptide, followed by another amino acid of which the mass and position in the sequence become easily determined.

Second, the ions corresponding to the first eight amino acids  $c_1$  to  $c_8$  are masked by intense matrix signals in the low *m/z* range (*not shown*) due to the fact that no precursor isolation is possible (ISD spectra are recorded in MS mode). The beginning of the sequence thus seems to be inaccessible which could constitute an important limitation of the technique. Nevertheless, specific methods termed "pseudo-MS<sup>3</sup>" are available to circumvent this limitation (Raska *et al.*, 2002; Suckau and Resemann, 2003). Since the ISD fragments are formed in the MALDI source, they can be isolated and fragmented by MS/MS like any other peptide. An MS/MS

spectrum generated with this strategy will permit characterization of the *N-terminus* extremity of a peptide if the selected ion is a *c*-type ion or the *C-terminus* one if it is a *z*-type ion.

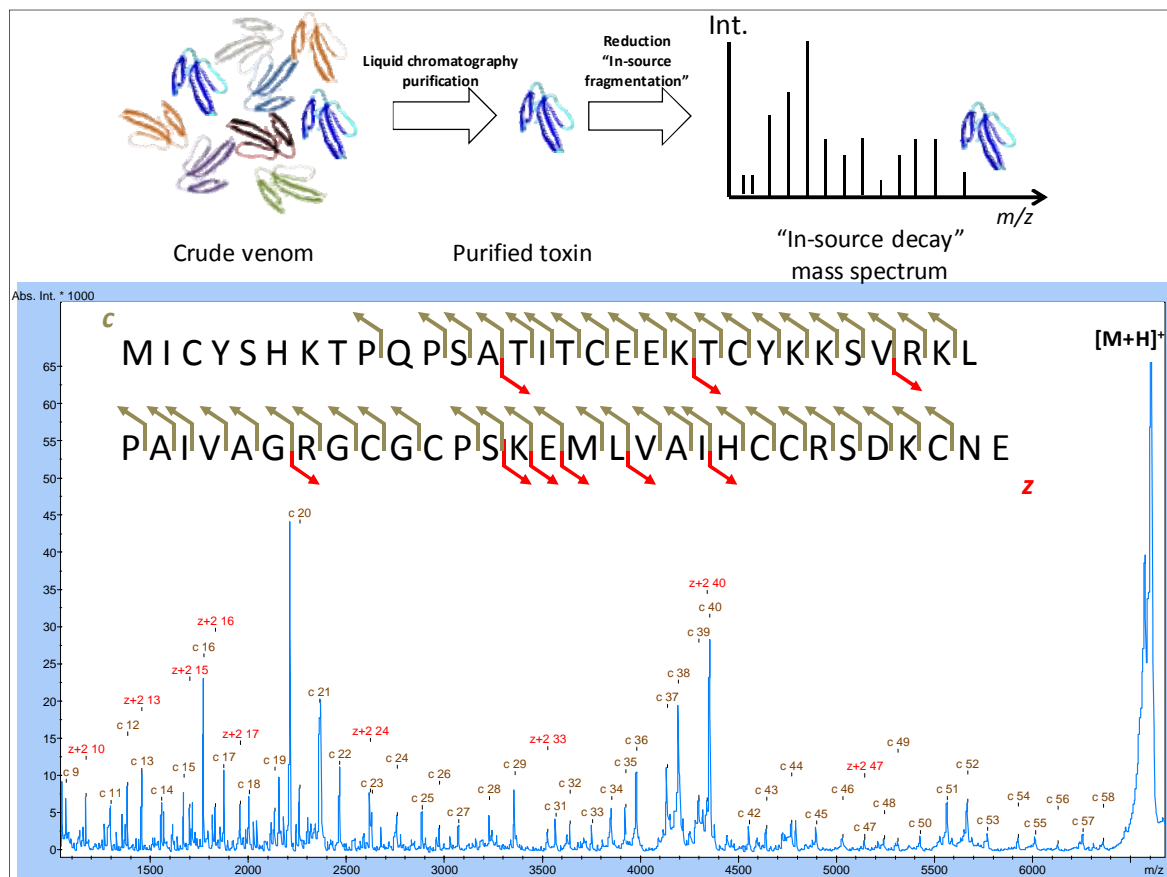

**Figure 5.** MALDI-MS/MS mass spectrum obtained for the toxin TA2 from *Dendroaspis angusticeps* venom [Spectrometer: Ultraflex II (Bruker Daltonics), matrix: 1,5-DAN, linear mode]. The spectrum displays a large *c*-ion series which allows the easy determination of 81.7% of the toxin sequence. The full sequence of this toxin was determined by a combination of bottom-up, top-down and Edman degradation experiments.

**Figure 5.** Spectre MALDI-MS/MS obtenu pour la toxine TA2 provenant du venin de *Dendroaspis angusticeps* [Spectromètre: Ultraflex II (Bruker Daltonics), matrice: 1,5-DAN, mode linéaire]. Le spectre montre une large série d'ions de type *c* qui permettent de caractériser 81,7% de la séquence de la toxine. La séquence complète de la toxine a été obtenue par une combinaison d'approches « bottom-up », « top-down » et de dégradation d'Edman.

Figure 6 shows a pseudo-MS<sup>3</sup> experiment used to characterize an Atdx1-K34A mutant. The top-panel shows the MALDI-MS/MS spectrum acquired in reflector mode. The large *c*- and *z*-ion series allow sequencing of a large portion of the toxin (68% sequence coverage). The mutation at position 34 can be quickly localized and characterized by measuring the difference between *c*<sub>34</sub> and *c*<sub>35</sub> fragment ions. However, as explained above, the C-terminal and N-terminal peptide sequences are missing as small fragment ions are hidden by matrix signals in the low mass range. The ion detected at *m/z* 2498.3 was then selected and fragmented by a CID-like technique (PSD). The resulting MS/MS spectrum is shown in Figure 6 (lower panel). Abundant *y*- and *b*-ions characterizing the missing *N-terminus* part are clearly detected. The same experiment can also be performed by isolating a *z*-ion to characterize the toxin *C-terminus* part. Using that strategy, the full sequence of toxins up to 10kDa can be determined by MALDI-TOF/TOF mass spectrometry.

### Conclusion

Animal venoms are increasingly the object of intense investigation due to their potential pharmacological uses and therapeutic properties. With sufficient amounts of starting material, Edman degradation remains a reliable and proven technology for the determination of amino acid sequences. However the experimental costs, the very low speed and low throughput and the amounts of pure protein needed are major limitations to large-scale sequencing projects especially for samples of high complexity and low protein contents. In this context, mass-spectrometry based strategies offer powerful solutions for the rapid, automated sequencing of unknown peptides from animal venoms.

Recent improvements in instrument sensitivity, speed and mass accuracy now offer the perspective of replacing Edman degradation by mass spectrometry sequencing. Although progress remains to be made for full,



automated sequence assignment, it is expected that the near future will see the mass spectrometer used as a massively parallel peptide sequencer that will permit fast, accurate peptide sequencing, in particular for complex peptide mixtures.

In this respect, the revolution awaiting us, parallels that of genome sequencing in terms of speed, accuracy, throughput and cost and will undoubtedly deliver great benefits in the exploration of animal venoms for the development of novel drugs, research and diagnostic tools.

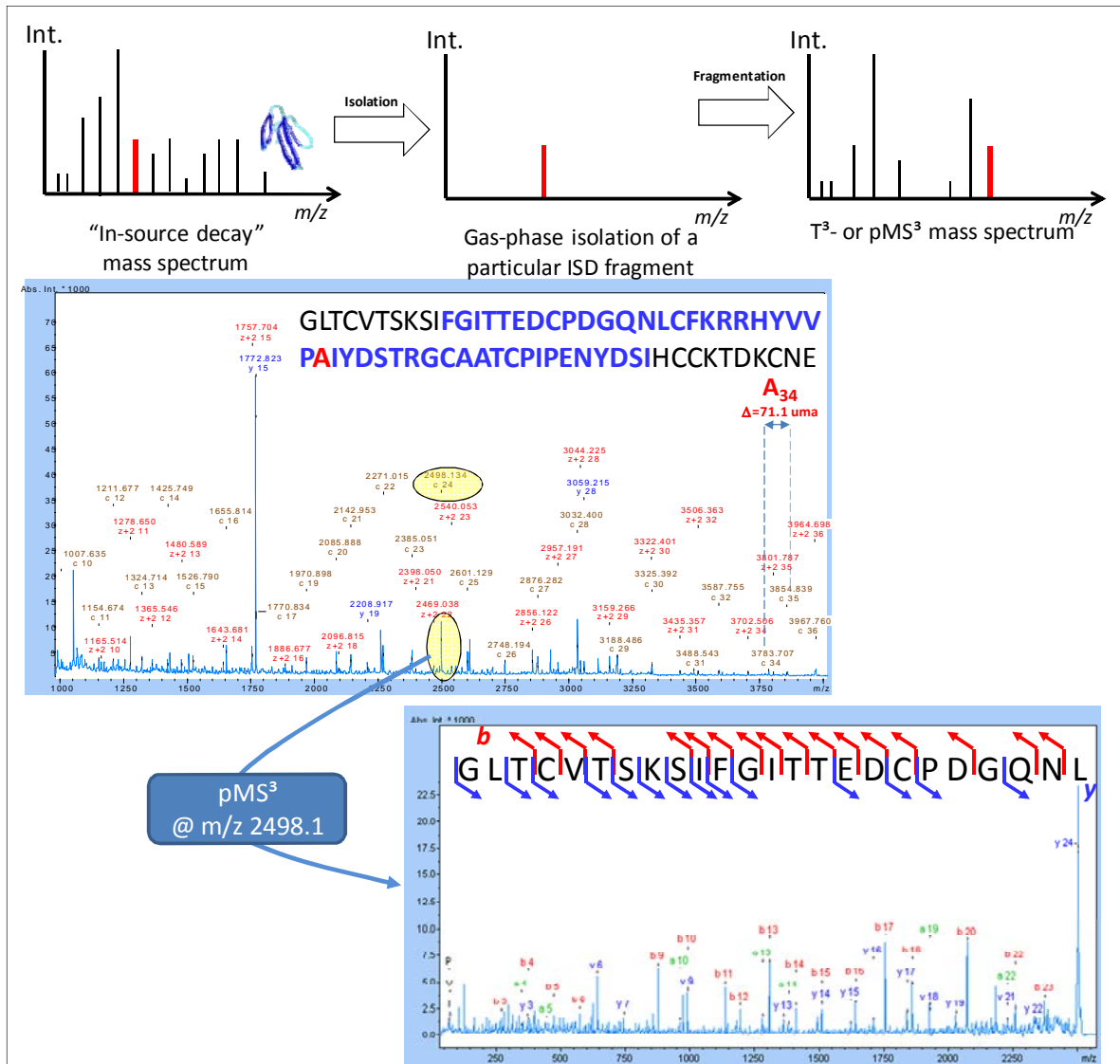

**Figure 6.** Illustration of a pMS<sup>3</sup> experiment applied to Adtx1-K34A [Spectrometer: Ultraflex II (Bruker Daltonics), matrix: 2,5-DHB, reflectron mode]. After reduction, the toxin is first fragmented within the source by ISD. To obtain the sequence of the first 10 amino acids hidden by intense matrix signals, an ISD fragment can be isolated and fragmented by CID. The generated MS/MS spectrum characterizes the N-terminus or C-terminus extremity of the peptide if the precursor ion was a c- or a z-ion, respectively.

**Figure 6.** Exemple d'une expérience "pseudo-MS<sup>3</sup>" appliquée à l'Adtx1-K34A [Spectromètre: Ultraflex II (Bruker Daltonics), matrice: 2,5-DHB, mode reflectron]. Après réduction, la toxine est tout d'abord fragmentée dans la source par « In-source Decay ». Afin d'obtenir la séquence des 10 premiers acides aminés cachés par le signal intense de la matrice (les spectres ISD sont acquis en mode MS), un ion ISD est isolé puis fragmenté par CID. L'analyse du spectre MS/MS ainsi obtenu caractérise l'extrémité N-terminale ou C-terminale selon que l'ion précurseur était de type c- ou z-, respectivement.

## References

- Aebersold R, Mann M (2003) Mass spectrometry-based proteomics. *Nature* **422**: 198-207
- Becker S, Terlau H (2008) Toxins from cone snails: properties, applications and biotechnological production. *Appl Microbiol Biotechnol* **79**: 1-9
- Breci LA, Tabb DL, Yates JR, III, Wysocki VH (2003) Cleavage N-terminal to proline: analysis of a database of peptide tandem mass spectra. *Anal Chem* **75**: 1963-1971

- Calvete JJ, Juarez P, Sanz L (2007) Snake venomomics. Strategy and applications. *J Mass Spectrom* **42**: 1405-1414
- Davis J, Jones A, Lewis RJ (2009) Remarkable inter- and intra-species complexity of conotoxins revealed by LC/MS. *Peptides* **30**: 1222-1227
- Demeure K, Quinton L, Gabelica V, Pauw ED (2007) Rational selection of the optimum MALDI matrix for Top-Down proteomics by in-source decay. *Anal Chem* **79**: 8678-8685
- Escoubas P, Celerier ML, Nakajima T (1997) High-performance liquid chromatography matrix-assisted laser desorption/ionization time-of-flight mass spectrometry peptide fingerprinting of tarantula venoms in the genus *Brachypelma*: Chemotaxonomic and biochemical applications. *Rapid Commun Mass Spectrom* **11**: 1891-1899
- Escoubas P, King GF (2009) Venomomics as a drug discovery platform. *Expert Rev Proteomics* **6**: 221-224
- Escoubas P, Quinton L, Nicholson GM (2008) Venomomics: unravelling the complexity of animal venoms with mass spectrometry. *J Mass Spectrom* **43**: 279-295
- Escoubas P, Sollod B, King GF (2006) Venom landscapes: mining the complexity of spider venoms via a combined cDNA and mass spectrometric approach. *Toxicon* **47**: 650-663
- Favreau P, Cheneval O, Menin L, Michalet S, Gaertner H, Principaud F, Thai R, Menez A, Bulet P, Stocklin R (2007) The venom of the snake genus *Atheris* contains a new class of peptides with clusters of histidine and glycine residues. *Rapid Commun Mass Spectrom* **21**: 406-412
- Fenn JB, Mann M, Meng CK, Wong SF, Whitehouse CM (1989) Electrospray ionization for mass spectrometry of large biomolecules. *Science* **246**: 64-71
- Fukuyama Y, Iwamoto S, Tanaka K (2006) Rapid sequencing and disulfide mapping of peptides containing disulfide bonds by using 1,5-diaminonaphthalene as a reductive matrix. *J Mass Spectrom* **41**: 191-201
- Hardouin J (2007) Protein sequence information by matrix-assisted laser desorption/ionization in-source decay mass spectrometry. *Mass Spectrom Rev* **26**: 672-682
- Hayashi MA, Ligny-Lemaire C, Wollberg Z, Wery M, Galat A, Ogawa T, Muller BH, Lamthanh H, Doljansky Y, Bdoah A, Stocklin R, Ducancel F (2004) Long-sarafotoxins: characterization of a new family of endothelin-like peptides. *Peptides* **25**: 1243-1251
- Jakubowski JA, Sweedler JV (2004) Sequencing and mass profiling highly modified conotoxins using global reduction/alkylation followed by mass spectrometry. *Anal Chem* **76**: 6541-6547
- Johnson RS, Martin SA, Biemann K, Stults JT, Watson JT (1987) Novel fragmentation process of peptides by collision-induced decomposition in a tandem mass-spectrometer - Differentiation of leucine and isoleucine. *Anal Chem* **59**: 2621-2625
- Karas M, Hillenkamp F (1988) Laser desorption ionization of proteins with molecular masses exceeding 10,000 daltons. *Anal Chem* **60**: 2299-2301
- Kelleher NL (2004) Top-down proteomics. *Anal Chem* **76**: 197A-203A
- Kjeldsen F, Haselmann KF, Sorensen ES, Zubarev RA (2003) Distinguishing of Ile/Leu amino acid residues in the PP3 protein by (hot) electron capture dissociation in Fourier transform ion cyclotron resonance mass spectrometry. *Anal Chem* **75**: 1267-1274
- Lewis RJ, Garcia ML (2003) Therapeutic potential of venom peptides. *Nat Rev Drug Discov* **2**: 790-802
- Mandal AK, Ramasamy MR, Sabareesh V, Openshaw ME, Krishnan KS, Balaram P (2007) Sequencing of T-superfamily conotoxins from *Conus virgo*: Pyroglutamic acid identification and disulfide arrangement by MALDI mass spectrometry. *J Am Soc Mass Spectrom* **18**: 1396-1404
- Mirgorodskaya E, Roepstorff P, Zubarev RA (1999) Localization of O-glycosylation sites in peptides by electron capture dissociation in a Fourier transform mass spectrometer. *Anal Chem* **71**: 4431-4436
- Nascimento DG, Rates B, Santos DM, Verano-Braga T, Barbosa-Silva A, Dutra AA, Biondi I, Martin-Eauclaire MF, De Lima ME, Pimenta AM (2006) Moving pieces in a taxonomic puzzle: venom 2D-LC/MS and data clustering analyses to infer phylogenetic relationships in some scorpions from the Buthidae family (Scorpiones). *Toxicon* **47**: 628-639
- Quinton L, Demeure K, Dobson R, Gilles N, Gabelica V, Pauw ED (2007) New method for characterizing highly disulfide-bridged peptides in complex mixtures: Application to toxin identification from crude venoms. *J Proteome Res* **6**: 3216-3223
- Quinton L, Le Caer JP, Phan G, Ligny-Lemaire C, Bourdais-Jomaron J, Ducancel F, Chamot-Rooke J (2005) Characterization of toxins within crude venoms by combined use of Fourier transform mass spectrometry and cloning. *Anal Chem* **77**: 6630-6639
- Quinton L, Le Caer JP, Vinh J, Gilles N, Chamot-Rooke J (2006) Fourier transform mass spectrometry: a powerful tool for toxin analysis. *Toxicon* **47**: 715-726
- Raska CS, Parker CE, Huang C, Han J, Glish GL, Pope M, Borchers CH (2002) Pseudo-MS3 in a MALDI orthogonal quadrupole-time of flight mass spectrometer. *J Am Soc Mass Spectrom* **13**: 1034-1041
- Rigby AC, Lucas-Meunier E, Kalume DE, Czerwiec E, Hambe B, Dahlqvist I, Fossier P, Baux G, Roepstorff P, Baleja JD, Furie BC, Furie B, Stenflo J (1999) A conotoxin from *Conus textile* with unusual posttranslational modifications reduces presynaptic Ca<sup>2+</sup> influx. *Proc Natl Acad Sci USA* **96**: 5758-5763
- Roepstorff P, Fohlman J (1984) Proposal for a common nomenclature for sequence ions in mass spectra of peptides. *Biomed Mass Spectrom* **11**: 601
- Rouget C, Quinton L, Maiga A, Gales C, Masuyer G, Malosse C, Chamot-Rooke J, Thai R, Mourier G, De Pauw E, Gilles N, Servent D (2010) Identification of a novel snake peptide toxin displaying high affinity and antagonist behaviour for the alpha(2)-adrenoceptors. *Br J Pharmacol* **161**: 1361-1374
- Shen GS, Layer RT, McCabe RT (2000) Conopeptides: From deadly venoms to novel therapeutics. *Drug Discov Today* **5**: 98-106
- Sleno L, Volmer DA (2004) Ion activation methods for tandem mass spectrometry. *J Mass Spectrom* **39**: 1091-1112
- Soares MR, Oliveira-Carvalho AL, Wermelinger LS, Zingali RB, Ho PL, Junqueira-de-Azevedo IL, Diniz MR (2005) Identification of novel bradykinin-potentiating peptides and C-type natriuretic peptide from *Lachesis muta* venom. *Toxicon* **46**: 31-38
- Spengler B, Kirsch D, Kaufmann R (1991) Metastable Decay of Peptides and Proteins in Matrix-Assisted Laser-Desorption Mass-Spectrometry. *Rapid Commun Mass Spectrom* **5**: 198-202
- Stocklin R, Mebs D, Boulain JC, Panchaud PA, Virelizier H, Gillard-Factor C (2000) Identification of snake species by toxin mass fingerprinting of their venoms. *Methods Mol Biol* **146**: 317-335

- Suckau D, Resemann A (2003) T3-sequencing: targeted characterization of the N- and C-termini of undigested proteins by mass spectrometry. *Anal Chem* **75**: 5817-5824
- Syka JE, Coon JJ, Schroeder MJ, Shabanowitz J, Hunt DF (2004) Peptide and protein sequence analysis by electron transfer dissociation mass spectrometry. *Proc Natl Acad Sci USA* **101**: 9528-9533
- Ueberheide BM, Fenyo D, Alewood PF, Chait BT (2009) Rapid sensitive analysis of cysteine rich peptide venom components. *Proc Natl Acad Sci USA* **106**: 6910-6915
- Zubarev RA (2004) Electron-capture dissociation tandem mass spectrometry. *Curr Opin Biotechnol* **15**: 12-16
-

## **Recent developments in the detection of phycotoxins**

Philipp HESS\*, Elodie NICOLAU

Ifremer, Centre Atlantique, Département Environnement Microbiologie et Phycotoxines, Laboratoire Phycotoxines, BP 21105, F-44311 Nantes cedex 03, France

\* Corresponding author ; E-mail : [philipp.hess@ifremer.fr](mailto:philipp.hess@ifremer.fr)

---

### **Abstract**

Over the past seven years, methods available for the detection of phycotoxins have been extensively reviewed in a number of international expert committees, such as the consultations organised by FAO/IOC/WHO and EFSA, as well as by individual scientists. These reviews have shown that the methods available have severe limitations for the use in official control, either due to their limited scope and detection capability or due to a lack of calibration standards, reference materials and validation efforts. The present review focuses on recent developments in the detection of phycotoxins in several areas of applied research. Not being able to exhaustively describe all recent developments, the review focussed on three areas of interest to the authors: (i) detection of ultra-trace amounts of toxins, (ii) metabolism of toxins and their localisation in biological tissues, and (iii) approaches to detect unknown toxins or analogues of known toxins. Miniaturisation in combination with physico-chemical techniques appears to be a very efficient approach to detect low trace amounts of individual toxin analogues. In particular, the detection of azaspiracids and okadaic acid and analogues, using micro-filtration and on-line pre-concentration techniques, has shown to be useful for the characterisation of various algal and shellfish species. In the area of interactions of toxins with shellfish and mammalian systems, it is noted that several studies on biomarkers reveal either protein biomarkers of exposure to toxins or potential pathways of metabolism of the toxins themselves. A particular focus is given to recent findings in the areas of brevetoxin metabolism and biomarkers as well as azaspiracid localisation and metabolism. Finally, the detection of novel compounds is a particularly challenging area. The interest in this area has risen over the past years following cases of unexplained mouse toxicity such as the UK cockle toxicity and the French atypical toxicity in mussels and oysters from the Atlantic and Mediterranean coasts. Some attention is given to immuno-, functional and cellular bio-assays for the identification of bioactive agents in shellfish.

### **Développements récents dans la détection des phycotoxines**

Durant les sept dernières années, les méthodes disponibles pour la détection des phycotoxines ont été abondamment revues dans de nombreux groupes internationaux d'expertises, tels que les consultations organisées par FAO/IOC/WHO et EFSA ainsi que dans de nombreux articles scientifiques de synthèse. Ces revues ont démontré que, vis-à-vis des systèmes de régulations officiels, les méthodes disponibles présentent des limites d'utilisation importantes. Soit elles ont un périmètre réduit et des limites de détection trop élevées, soit il y a un manque d'étalons, de matériaux de référence ou d'efforts de validation. La présente revue focalise sur les développements récents dans la détection de phycotoxines en recherche appliquée. Sans vouloir décrire de manière exhaustive tous les développements récents, la revue examine trois domaines d'intérêt pour les auteurs : (i) la détection de quantités ultra-traces de toxines, (ii) la métabolisation et la localisation des toxines dans des tissus biologiques, et (iii) les approches pour la détection de toxines non-répertoriées ou des analogues de toxines connues. La miniaturisation en combinaison avec les techniques physico-chimiques constitue apparemment une approche efficace pour la détection de faibles traces d'analogues individuels des toxines. En particulier, la micro-filtration et des techniques de pré-concentration en ligne se sont montrées utiles pour la détection des azaspiracides et des toxines du groupe de l'acide okadaïque dans la caractérisation de diverses espèces d'algues et de coquillages. Dans le domaine des interactions des toxines avec les coquillages et des systèmes vivants de mammifères, nous avons noté que plusieurs études sur les bio-marqueurs révèlent soit des marqueurs protéiniques d'exposition aux toxines, soit des marqueurs du métabolisme des toxines elles-mêmes. Un intérêt spécifique a été trouvé dans les résultats d'étude sur le métabolisme des brevetoxines et des azaspiracides. La détection des composés bioactifs non-répertoriés constitue un défi particulièrement difficile. Ce domaine a trouvé plus d'intérêt dû à plusieurs cas de toxicités inexpliquées dans le test souris telles que les toxicités observées dans les coques en provenance de Grande-Bretagne ou encore dans les moules et huîtres des côtes méditerranéennes et atlantiques françaises. Une attention particulière a été consacrée à l'identification d'agents bioactifs par les essais cellulaires ou fonctionnels ou basés sur la détection immuno-chimique.

**Keywords** : Marine biotoxins, metabolism, localisation, passive sampling, proteomics.

---

## Methodological requirements for official control and research applications

Over the past two decades, methodology for the detection of marine biotoxins has rapidly evolved for many areas of application. The main drivers for methodological developments were the need for efficient and complete detection of toxins in shellfish for the purpose of public health and the multitude of scientific questions that require particular detection methods to be answered. Such distinct questions range over many disciplines from the elucidation of biosynthetic pathways over the theme of harmful algal bloom dynamics to the localisation of toxins in shellfish and their metabolism at various trophic levels. Previous reviews have mainly focussed on the evaluation of available detection technologies and their application in official control. Such reviews have been carried out in a systematic manner during risk evaluation at European or international level such as the FAO/IOC/WHO expert consultation exercise (Anonymous, 2005) or the more recent assessments of the European Food Safety Authority (EFSA 2008a, 2008b, 2009a, 2009b, 2009c, 2009d, 2009e). Individual scientists have also critically assessed available methodology, in particular comparing the performance of physico-chemical analytical tools and biological assays (Hess, 2010; Humpage *et al.*, 2010; Vilariño *et al.*, 2010). Reviews focusing on the suitability of methods for official control clearly show that there are few methods that are validated to a level that satisfies typical formal requirements for their application. While mammalian bioassays are at the limit of being capable to implement current legal limits for phycotoxins, chemical detection methods suffer from limitations in the scope of method due to the lack of a suitable range of calibration standards for all toxicologically relevant analogues. The latter issue has been addressed extensively over the last few years, either at the National Research Council of Canada's Institute of Marine Biosciences in Halifax or by other international initiatives (Hess *et al.*, 2007). Biological and biochemical tools have also been extensively developed for toxin detection using a) antibodies (enzyme-linked immuno-sorbent assays (ELISA), lateral flow immuno-chromatography (LFIC) and surface plasmon resonance (SPR)-based methods), b) functional assays (PP2a-inhibition assay and receptor-binding assays) and c) cellular functional assays, including assessment of hemolytic activity and others. Most of these biochemical or cellular assays have a major drawback for official control purposes: they are specific to a single toxin group or a subset of toxin groups and therefore, multiple combinations of assays are necessary to assess the toxicity of any shellfish sample.

Nonetheless, the development of the above-mentioned techniques has allowed many areas of applied research to respond to the numerous questions around biotoxins. This review focuses on recent developments in the area of research applications. In following the toxins from their producing organisms over the shellfish vectors to the human targets, three areas of research have attracted our interest: i) methods applied to detect low amounts of toxins in seawater and algal cells, ii) techniques used for the characterisation of toxin biotransformation and their localisation in shellfish and finally iii) approaches for the characterisation of biological activity in toxin producers and shellfish. The requirements for detection techniques in research application often differ dramatically from those of official control. While traceability to international standards is mandatory in the area of official control, it is often negligible in the area of research as here most studies are concerned with proof of principles. Detection and quantitation capabilities are important for both areas; however, significant efforts are often made in research applications to achieve detection, while the same efforts could not be justified in routine control.

## Methods for the detection of ultra-trace levels of toxins

An interesting approach for the detection of very small quantities of toxins was developed by Hardstaff *et al.* (Hardstaff *et al.*, 2006), using hyphenated chromatography for the analysis of algal cells. The technique developed has overcome difficulties in the detection of low toxin amounts in cells of *Alexandrium ostenfeldii* by applying micro-extraction on spin-filters, followed by large-volume injection and reversed-flow, two-dimensional chromatography prior to detection by liquid chromatography coupled to tandem mass spectrometry (LC-MS-MS). In this way, the detection of spirulides from as few as 50 hand-picked cells became possible, and the correlation of toxin content with cell-size could be made for the first time in the area of algal toxins. We have subsequently applied the same technique for the detection of low amounts of azaspiracids in Portuguese shellfish (Vale *et al.*, 2008). This study clarified the geographical extent of the occurrence of azaspiracids (AZAs) which had previously not been detected in Portugal. This finding completed the picture of occurrence all along the Atlantic arch from Norway to Morocco (Twiner *et al.*, 2008). Although the technique itself is not recommended for use in routine official control, it has allowed for the characterisation of the danger posed by this toxin group. The technique had also proven useful to elucidate the phenomena of toxin production by American species of *Dinophysis* (Hackett *et al.*, 2009). While *Dinophysis* had been associated with the production of okadaic acid (OA) and analogues in a number of regions in Europe and Asia, the same algal species had not been causing toxicity in North American shellfish until very recently (Swanson *et al.*, 2010). Hackett *et al.* (2009) clearly demonstrated that *Dinophysis acuminata* from the Gulf of Maine is capable of producing toxins in culture although at very low concentrations compared to other strains. Additionally, an interesting profile was discovered showing large proportions of OA as diol-ester while Dinophysistoxin-1 (DTX1) was present as the free toxin (Figure 1). These findings will also need to be followed through using biosynthetic studies of both toxins. Additionally, a combination of LC-MS-MS, biochemical and cellular techniques were used to find low amounts of OA in a Malaysian species of *Prorocentrum rathymum* (Caillaud *et al.*, 2010).

A different approach to detect low amounts of toxins directly in seawater was proposed by MacKenzie *et al.* (MacKenzie *et al.*, 2004) through the use of passive samplers. Although this approach had frequently been used

in the area of environmental contaminants and natural products discovery, it was only in 2004 that these authors applied passive samplers to marine biotoxin research. Although initially proposed as a technique that could be implemented to provide early warning of toxin occurrence to shellfish farms, a subsequent study has shown the limitations of this approach by demonstrating that the early warning would have had to be placed at distant sites due to the rapid advection of algae and the rapid accumulation by shellfish (Fux *et al.*, 2009). Nevertheless, the passive sampling techniques clearly have a role to play in prospecting for new shellfish cultivation areas, both in coastal and off-shore aquaculture.

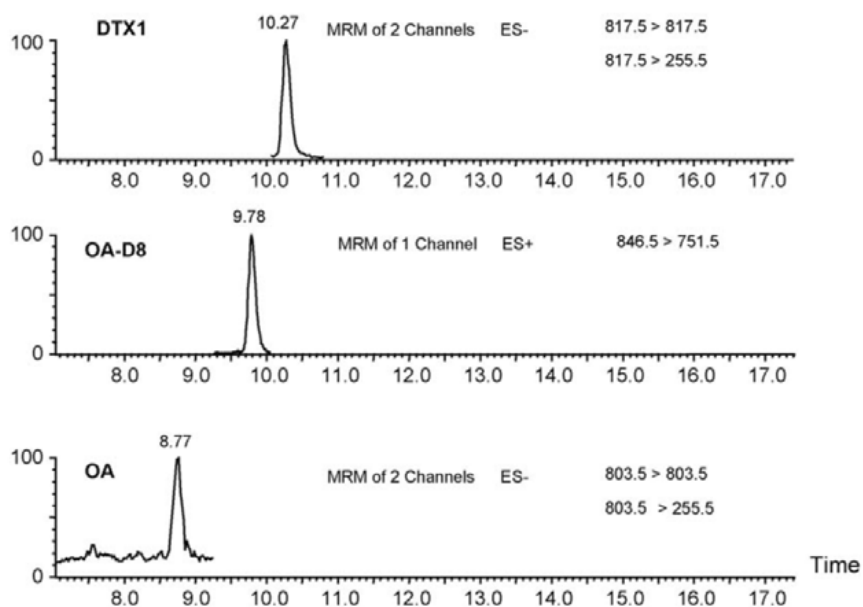

**Figure 1.** LC-MS-MS chromatogram showing the profile of OA-group toxins in American *Dinophysis acuminata* from the Gulf of Maine. Adapted from Hackett *et al.*, 2009.

**Figure 1.** Chromatogramme CL-SM-SM clarifiant le profil de toxines du groupe AO dans du *Dinophysis acuminata* américain provenant du golfe du Maine. Adapté de Hackett *et al.*, 2009.

These studies show that the application of specialised techniques is often necessary to answer specific questions. Overall, the study of such low quantities of toxins in seawater, algal strains of potentially toxic species, or in shellfish accumulating these, leads to the question of the relevance to food safety. At this stage, only the potential for toxin production and occurrence can be demonstrated while further research will be necessary to demonstrate whether environmental parameters trigger changes in the production of toxins by these species.

## Methods used in the localisation and metabolism of toxins in shellfish and mammals

A recent study investigated the organ distribution of AZA1 through sublethal oral dosing in mice (Aasen *et al.*, 2010). While highest concentrations after 24 h were found in the stomach and duodenum, the toxin was also readily absorbed into inner organs in a dose-dependent manner, with highest concentrations being found in the kidneys, liver and spleen followed by detectable concentrations in lung and heart. After seven days, the toxin levels had dropped significantly in all organs, except for the kidneys. However, the total amount of toxin found in the internal organs of mice only accounted for ca. 2% of the total dose given, which is consistent with pathological changes only being observed in the intestinal body parts. Thus, further studies will be necessary to investigate whether excretion played a major role or whether transformation into metabolites is a significant contributing factor. In analogy to their above-mentioned work on brevetoxins, Guo *et al.* also demonstrated that okadaic acid is effectively metabolised by mammalian cytochrome P450s (Guo *et al.*, 2010). Interestingly, the okadaic acid structure is also oxidised by human CYP3A4 and CYP3A5 into its hydroxy-metabolites. Still, it remains to be investigated which of the enzymes involved in the metabolism of AZA are of shellfish and which are of mammalian origin.

Understanding the metabolism of marine biotoxins in live animals is another area of challenging research. Enzyme levels may vary much in different biological tissues, therefore, localisation of toxins in different tissues or sub-cellular organelles will also play a major role in the full comprehension of metabolism.

When examining the metabolism in shellfish, a first major stumbling block is the lack of the complete genome of any shellfish species. Although several studies are underway to overcome this lack, current knowledge of shellfish proteins remains rather limited. This lack results in the studies on shellfish proteins involved in toxin metabolism being much more complex and less conclusive in terms of the proteins involved.

Principally, when examining the interactions of shellfish proteins with toxins, there could be a distinction of three phenomena: i) binding of toxins by proteins without metabolism ii) metabolism of toxins by existing or pre-expressed proteins iii) metabolism of toxins by induced proteins. In addition, the toxicity of biotoxins to the shellfish themselves must not be underestimated (Landsberg, 2002).

Proteomic biomarkers of pollution with xenobiotics have been effectively demonstrated in mussels (Apraiz *et al.*, 2006). Similarly, the localisation of lipophilic chemicals at specific binding sites had been shown, for instance, for phenanthrene and polychlorinated biphenyls in mussels (Einsporn and Koehler, 2008).

Rossignoli and Blanco 2008 have investigated for the first time the distribution of OA in different cell types of mussel digestive glands (Rossignoli and Blanco, 2008). Subsequently, this group have investigated the sub-cellular distribution of OA (Rossignoli and Blanco, 2010). In this study, the authors applied a combination of protein isolation techniques and toxin analysis with enzymatic digestion of proteins to suggest that a lipoprotein was the main agent binding OA in the cytosol of mussel digestive gland cells. Further research will be necessary to corroborate this work.

When investigating the digestive gland proteome of shellfish exposed to toxic algae, a complex picture was obtained (Figure 2). The comparison of shellfish exposed to a non-toxic feed alga as control with those exposed to toxic *Alexandrium* outlines how many proteins are over-expressed as a function of the toxic insult presented to the shellfish (unpublished work from the authors' laboratory).

In principle, the proteins identified in exposed digestive glands can either originate from the shellfish (normally present or induced) or may arise from the toxic algae themselves. Such an algal biomarker has been identified in mussels naturally exposed to *Dinophysis* (Ronzitti *et al.*, 2008). In a freshwater system, the clam *Corbicula fluminea* expressed a number of proteins in the digestive tract following exposure to *Microcystis aeruginosa*, a toxic cyanobacterium producing microcystins (Martins *et al.*, 2009). The proteins were shown to be involved in the cytoskeleton assembly and proteins with metabolic activity. These results were coherent with the toxic effects of microcystins on PP2a. Marine bivalves have also been shown to contain significant amounts of PP2a and the reaction of the bivalves should include metabolism followed by excretion or sequestration of the toxins in the digestive tract to prevent their distribution across other organs (Suzuki *et al.*, 2005).

Brevetoxin biomarkers in shellfish and humans have been outlined in a recent review (Plakas and Dickey, 2010). The involvement of cytochrome P450 mediated metabolism of brevetoxins has also recently been shown (Guo *et al.*, 2010). Interestingly, the exposure of brevetoxin-2 (PbTx-2) to human liver microsomes resulted in a number of known metabolites in shellfish, e.g. BTX-B5.

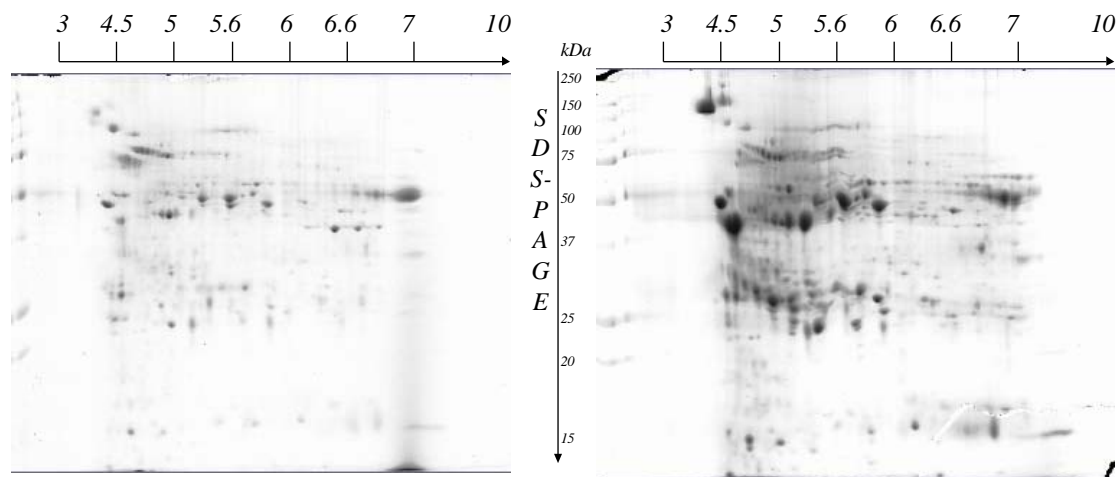

**Figure 2.** Two dimensional SDS-PAGE analysis of the protein fraction of mussel digestive glands following 1-day exposure to non-toxic *Skeletonema costatum* (left) and toxic *Alexandrium minutum* (right).

**Figure 2.** Analyse bi-dimensionnelle SDS-PAGE de la fraction protéinique de glande digestive de moules exposées pendant 1 jour à de la culture de *Skeletonema costatum* non-toxique (gauche) et de la culture toxique d'*Alexandrium minutum* (droite).

The same metabolites were also produced upon exposure of PbTx-2 to nine human recombinant cytochrome P450s. In particular, human CYP3A4 metabolised the terminal aldehyde-group in PbTx-2 to the carboxylic acid group of BTX-B5. A novel metabolite was also detected in the study of these human enzymes, outlining the importance of metabolism studies in the comprehension of human exposure to toxins.

Azaspiracids are another toxin group for which multiple metabolites have been identified in shellfish (Rehmann *et al.*, 2008). A pathway of oxidative metabolism in mussels has been recently postulated for AZAs (McCarron *et al.*, 2009). As only AZA1 and -2 have been identified in the producing organism, *Azadinium spinosum*, several mechanisms must be assumed to explain the multitude of analogues determined. Two separate reactions of hydroxylation at carbon 3 (in the Western part of the molecule) and at carbon 23 (at the

E-ring of the skeleton), and a further oxidation at the E-ring may be followed by spontaneous decarboxylation, as demonstrated by studies using deuterated methanol (McCarron *et al.*, 2009). These four reactions may suffice to explain the multitude of analogues detected so far. Nzoughet *et al.* recently investigated proteins in mussels exposed to AZAs (Nzoughet *et al.*, 2008; Nzoughet *et al.*, 2009). Using IEF, size exclusion chromatography and SDS-page, these authors initially isolated two proteins of ca. 22 and 45 kDa to which AZAs bind (Nzoughet *et al.*, 2008). In a follow-up study, four proteins were identified, three of which appeared to belong to the mussels themselves whereas the fourth protein was a bacterial flagellar protein (Nzoughet *et al.*, 2009). Further research is currently underway to examine if these bacteria are symbiotically associated with the causative organism and may as such serve as biomarkers of exposure to the organism. In addition, it remains to be clarified if it is the same shellfish proteins to which AZA is found to bind strongly that also metabolise AZA. As initial comparative analysis suggests homology of these proteins with cathepsin D, superoxide dismutase and glutathion S-transferase, the metabolic pathway postulated may yet be more complicated than anticipated.

## Approaches for the characterisation of biological activity in toxin producers and shellfish

The above-mentioned risk evaluations by FAO/IOC/WHO and EFSA have led to a major change in legislation for the control of lipophilic marine biotoxins in shellfish for which the reference method will be based on LC-MS technology. This change has been presented at global level to Codex Alimentarius, World Health and Trade Organisations (WHO and WTO) and initial reactions from some countries have made it abundantly clear that phasing in of this change will require several years. In addition, the precautionary principle is maintained but responsibility for this area is put in the EU on individual Member States. While equivalence of biological testing and LC-MS testing could be successfully shown for AZAs at levels around the current regulatory limit (Hess *et al.*, 2009), the performance of biological assays at lower levels or for other toxin groups has not proven sufficient. With the increased Member State responsibility of vigilance for novel toxic agents and the routine implementation of chemical testing, it becomes more important to have efficient tools for the detection of unknown bioactive molecules in shellfish. Several research initiatives have already started in this area and will need to be strengthened to address the issue.

A major effort has been made in the detection of neurotoxic bioactive molecules (Ledreux *et al.*, 2009). The authors have developed an approach with cellular assays to allow for the detection of a variety of known shellfish toxin groups and to point to large groups of biological targets of neurotoxic compounds. However, the shellfish matrix still poses problems of interference with the assay and further efforts will be necessary to overcome this issue.

A test applicable for both marine and freshwater toxins was optimised using recombinant enzymes (PP2A) (Ikehara *et al.*, 2008), and quantitative structure activity relationships of a number of analogues could be established thus allowing for more effective monitoring of microcystins (Ikehara *et al.*, 2009).

In the area of lipophilic toxins, significant progress was achieved using a neuro-2A cell bioassay in one laboratory (Canete and Diogene, 2008; Canete *et al.*, 2010; Canete and Diogene, 2010), however, it will be interesting to see whether this approach can be reproduced in a larger number of laboratories. The same authors also proved that their model can be used in combination with LC-MS-MS and PP2a for detection of OA in *P. rathymum* (Caillaud *et al.*, 2010) or for previously unknown maitotoxin-like compounds (Caillaud *et al.*, 2010). Finally, these authors also demonstrated the effectiveness of the cellular assay when coupled with fractionation HPLC for both shellfish and micro-algal matrices, although the assay format requires 48 h exposure for best sensitivity (Caillaud *et al.*, 2009).

## Conclusions

Significant progress has been made in several areas of biotoxin methodology. Among such areas we found particularly interesting the techniques used in the ultra-trace detection of phycotoxins, those in the area of proteomics and toxin metabolism and those in the area of biological screening tools.

We anticipate that these three areas will heavily influence the developments in coming years as they will allow for better prediction and monitoring of algal toxins, better understanding of their fate in the marine food chain and better public health protection.

## References

- Aasen JAB, Espenes A, Hess P, Aune T (2010) Sub-lethal dosing of azaspiracid-1 in female NMR1 mice. *Toxicon* **56**: 1419-1425
- Anonymous (2005) Report of the Joint FAO/IOC/WHO *ad hoc* Expert Consultation on Biotoxins in Bivalve Molluscs, Oslo, Norway, Sep 26-30 2004. 40 pages, Web-publication: [http://www.fao.org/es/ESN/food/risk\\_biotoxin\\_en.stm](http://www.fao.org/es/ESN/food/risk_biotoxin_en.stm)
- Apraiz I, Mi J, Cristobal S (2006) Identification of Proteomic Signatures of Exposure to Marine Pollutants in Mussels (*Mytilus edulis*). *Mol Cell Proteomics* **5**: 1274-1285
- Caillaud A, Cañete E, de la Iglesia P, Giménez G, Diogène J (2009) Cell-based assay coupled with chromatographic fractionating: A strategy for marine toxins detection in natural samples. *Toxicol In Vitro* **23**: 1591-1596
- Caillaud A, de la Iglesia P, Campàs M, Elandaloussi L, Fernández M, Mohammad-Noor N, Andree K, Diogène J (2010) Evidence of okadaic acid production in a cultured strain of the marine dinoflagellate *Prorocentrum rathymum* from Malaysia. *Toxicon* **55**: 633-637



- Caillaud A, Yasumoto T, Diogène J (2010) Detection and quantification of maitotoxin-like compounds using a neuroblastoma (Neuro-2a) cell based assay. Application to the screening of maitotoxin-like compounds in *Gambierdiscus* spp. *Toxicon* **56**: 36-44
- Canete E, Campas M, de la Iglesia P, Diogene J (2010) NG108-15 cell-based and protein phosphatase inhibition assays as alternative semiquantitative tools for the screening of lipophilic toxins in mussels. Okadaic acid detection. *Toxicol In Vitro* **24**: 611-619
- Canete E, Diogene J (2008) Comparative study of the use of neuroblastoma cells (Neuro-2a) and neuroblastoma x glioma hybrid cells (NG108-15) for the toxic effect quantification of marine toxins. *Toxicon* **52**: 541-550
- Canete E, Diogene J (2010) Improvements in the use of neuroblastoma x glioma hybrid cells (NG108-15) for the toxic effect quantification of marine toxins. *Toxicon* **55**: 381-389
- EFSA (2008a) Marine biotoxins in shellfish - Azaspiracid group, Scientific Opinion of the Panel on Contaminants in the Food chain, adopted on 9 June 2008. *EFSA Journal* **723**: 1-52
- EFSA (2008b) Marine biotoxins in shellfish - Okadaic Acid and analogues, Scientific Opinion of the Panel on Contaminants in the Food chain, adopted on 27 November 2007. *EFSA Journal* **589**: 1-62
- EFSA (2009a) Marine biotoxins in shellfish - Domoic acid group, Scientific Opinion of the Panel on Contaminants in the Food chain; adopted on 2 July 2009. *EFSA Journal* **1181**: 1-61
- EFSA (2009b) Marine biotoxins in shellfish - Pectenotoxin group, Scientific Opinion of the Panel on Contaminants in the Food chain; adopted on 27 May 2009. *EFSA Journal* **1109**: 1-47
- EFSA (2009c) Marine biotoxins in shellfish - Saxitoxin group; Scientific Opinion of the Panel on Contaminants in the Food Chain, Adopted on 25 March 2009. *EFSA Journal* **1019**: 1-76
- EFSA (2009d) Marine biotoxins in shellfish - Summary Opinion, Scientific Opinion of the Panel on Contaminants in the Food chain; adopted on 13 August 2009. *EFSA Journal* **1306**: 1-23
- EFSA (2009e) Marine biotoxins in shellfish - Yessotoxin group, Scientific Opinion of the Panel on Contaminants in the Food chain, adopted on the 2 December 2008. *EFSA Journal* **907**: 1-62
- Einsporn S, Koehler A (2008) Electron-microscopic localization of lipophilic chemicals by an antibody-based detection system using the blue mussel *Mytilus edulis* as a model system. *Environ Toxicol Chem* **27**: 554-560
- Fux E, Bire R, Hess P (2009) Comparative accumulation and composition of lipophilic marine biotoxins in passive samplers and in mussels (*M. edulis*) on the West Coast of Ireland. *Harm Algae* **8**: 523-537
- Guo F, An T, Rein KS (2010) The algal hepatotoxin okadaic acid is a substrate for human cytochromes CYP3A4 and CYP3A5. *Toxicon* **55**: 325-332
- Guo F, An T, Rein KS (2010) Human metabolites of brevetoxin PbTx-2: Identification and confirmation of structure. *Toxicon* **56**: 648-651
- Hackett JD, Tong M, Kulis DM, Fux E, Hess P, Bire R, Anderson DM (2009) DSP toxin production *de novo* in cultures of *Dinophysis acuminata* (Dinophyceae) from North America. *Harm Algae* **8**: 873-879
- Hardstaff WR, Lewis N, Aasen J, Quilliam MA (2006) Analysis of phycotoxins in hand-picked plankton cells by micro-column liquid chromatography-tandem mass spectrometry. Poster presented at the *XIIth Harmful Algal Bloom Conference*, Copenhagen, Denmark, 4 - 8 September 2006
- Hess P (2010) Requirements for screening and confirmatory methods for the detection and quantification of marine biotoxins in end-product and official control. *Anal Bioanal Chem* **397**: 1683-1694
- Hess P, Butter T, Petersen A, Silke J, McMahon T (2009) Performance of the EU-harmonised mouse bioassay for lipophilic toxins for the detection of azaspiracids in naturally contaminated mussel (*Mytilus edulis*) hepatopancreas tissue homogenates characterised by liquid chromatography coupled to tandem mass spectrometry. *Toxicon* **53**: 713-722
- Hess P, McCarron P, Rehmann N, Kilcoyne J, McMahon T, Ryan G, Ryan MP, Doucette GJ, Satake M, Ito E, Yasumoto T (2007) Isolation and purification of AZAs from naturally contaminated materials, and evaluation of their toxicological effects (ASTOX). In *Marine Environment & Health Series*, n° 28. Irish Marine Institute: Ireland
- Humpage A, Magalhaes V, Froschio S (2010) Comparison of analytical tools and biological assays for detection of paralytic shellfish poisoning toxins. *Anal Bioanal Chem* **397**: 1655-1671
- Ikehara T, Imamura S, Oshiro N, Ikehara S, Shinjo F, Yasumoto T (2008) A protein phosphatase 2A (PP2A) inhibition assay using a recombinant enzyme for rapid detection of microcystins. *Toxicon* **51**: 1368-1373
- Ikehara T, Imamura S, Sano T, Nakashima J, Kuniyoshi K, Oshiro N, Yoshimoto M, Yasumoto T (2009) The effect of structural variation in 21 microcystins on their inhibition of PP2A and the effect of replacing cys269 with glycine. *Toxicon* **54**: 539-544
- Landsberg J.H (2002) The effects of harmful algal blooms on aquatic organisms. *Rev Fish Sci* **10**: 113-390
- Ledreux A, Krysz S, Bernard C (2009) Suitability of the Neuro-2a cell line for the detection of palytoxin and analogues (neurotoxic phycotoxins). *Toxicon* **53**: 300-308
- MacKenzie L, Beuzenberg V, Holland P, McNabb P, Selwood A (2004) Solid phase adsorption toxin tracking (SPATT): a new monitoring tool that simulates the biotoxin contamination of filter feeding bivalves. *Toxicon* **44**: 901-918
- Martins JC, Leao PN, Vasconcelos V (2009) Differential protein expression in *Corbicula fluminea* upon exposure to a *Microcystis aeruginosa* toxic strain. *Toxicon* **53**: 409-416
- McCarron P, Kilcoyne J, Miles CO, Hess P (2009) Formation of azaspiracids-3,-4,-6, and-9 *via* decarboxylation of carboxyazaspiracid metabolites from shellfish. *J Agric Food Chem* **57**: 160-169
- Nzougheh JK, Hamilton JTG, Botting CH, Douglas A, Devine L, Nelson J, Elliott CT (2009) Proteomics identification of azaspiracid toxin biomarkers in blue mussels, *Mytilus edulis*. *Mol Cell Proteomics* **8**: 1811-1822
- Nzougheh KJ, Hamilton JTG, Floyd SD, Douglas A, Nelson J, Devine L, Elliott CT (2008) Azaspiracid: First evidence of protein binding in shellfish. *Toxicon* **51**: 1255-1263
- Plakas SM, Dickey RW (2010) Advances in monitoring and toxicity assessment of brevetoxins in molluscan shellfish. *Toxicon* **56**: 137-149
- Rehmann N, Hess P, Quilliam MA (2008) Discovery of new analogs of the marine biotoxin azaspiracid in blue mussels (*Mytilus edulis*) by ultra-performance liquid chromatography/tandem mass spectrometry. *Rapid Commun Mass Spectrom* **22**: 549-558

- Ronzitti G, Milandri A, Scortichini G, Poletti R, Rossini GP (2008) Protein markers of algal toxin contamination in shellfish. *Toxicon* **52**: 705-713
- Rossignoli AE, Blanco J (2008) Cellular distribution of okadaic acid in the digestive gland of *Mytilus galloprovincialis* (Lamarck, 1819). *Toxicon* **52**: 957-959
- Rossignoli AE, Blanco J (2010) Subcellular distribution of okadaic acid in the digestive gland of *Mytilus galloprovincialis*: First evidences of lipoprotein binding to okadaic acid. *Toxicon* **55**: 221-226
- Suzuki T, Igarashi T, Ichimi K, Watai M, Suzuki M, Ogiso E, Yasumoto Y (2005) Kinetics of Diarrhetic Shellfish Poisoning toxins, okadaic acid, dinophysistoxin-1, pectenotoxin-6 and yessotoxin in scallops *Patinopectin yessoensis*. *Fish Sci* **71**: 948-955
- Swanson KM, Flewelling LJ, Byrd M, Nunez A, Villareal TA (2010) The 2008 Texas *Dinophysis ovum* bloom: Distribution and toxicity. *Harm Algae* **9**: 190-199
- Twiner MJ, Rehmann N, Hess P, Doucette GJ (2008) Azaspiracid shellfish poisoning: A review on the chemistry, ecology, and toxicology with an emphasis on human health impacts. *Mar Drugs* **6**: 39-72
- Vale P, Bire R, Hess P (2008) Confirmation by LC-MS/MS of azaspiracids in shellfish from the Portuguese north-western coast. *Toxicon* **51**: 1449-1456
- Vilariño N, Louzao M, Vieytes M, Botana L (2010) Biological methods for marine toxin detection. *Anal Bioanal Chem* **397**: 1673-1681
-



## Recent advances in marine biotoxins monitoring

Riadh MARROUCHI<sup>1,2</sup>, Evelyne BENOIT<sup>2</sup>, Jordi MOLGO<sup>2</sup>, Riadh KHARRAT<sup>1\*</sup>

<sup>1</sup> Laboratoire des Toxines Alimentaires, Institut Pasteur de Tunis, 13 Place Pasteur, B.P. 74, 1002 Tunis-Belvédère, Tunisie ; <sup>2</sup> CNRS, Institut de Neurobiologie Alfred Fessard - FRC2118, Laboratoire de Neurobiologie et Développement – UPR3294, 1 avenue de la Terrasse, F-91198 Gif sur Yvette cedex, France

\* Corresponding author ; Tel : +21671842609 ; Fax : +21671842755 ; E-mail : [riadh.kharrat@pasteur.rns.tn](mailto:riadh.kharrat@pasteur.rns.tn)

---

### Abstract

The rapid and reliable detection of phycotoxins and the estimation of their toxicity represent considerable challenges in the context of seafood and public health issues. Over the last fifteen years, multitude of biological, biochemical and chemical processes were developed to detect, identify and quantify phycotoxins. Official control in many countries has been carried out using mouse bioassays for marine biotoxins monitoring. Because of the low sensitivity of this test, associated with animal ethic problems, other alternative assays have been performed such as analytical chemistry, especially high performance liquid chromatography and liquid chromatography coupled to mass spectrometry, immunoassay techniques (enzyme-linked immunosorbent assay and surface plasmon resonance), pharmacology-based method (receptor binding assay) and passive sampling method (solid-phase adsorption toxin tracking).

### Les progrès récents dans la surveillance des biotoxines marines

La rapidité et la fiabilité de détection des phycotoxines et l'estimation de leur toxicité chez les produits marins, notamment les mollusques bivalves, représentent actuellement un défi considérable pour le secteur conchylicole et pour la santé publique. Au cours des quinze dernières années, plusieurs méthodes biologiques, biochimiques et chimiques ont été développées pour détecter, identifier et quantifier les phycotoxines. Dans de nombreux pays, le contrôle officiel des biotoxines marines se fait par le test biologique sur souris. A cause de la faible sensibilité de ce test, associé à des problèmes d'éthique animale, d'autres tests ont été développés tels que des méthodes analytiques, en particulier la chromatographie en phase liquide à haute performance et la chromatographie en phase liquide couplée à la spectrométrie de masse, des techniques immunologiques (l'analyse enzyme-joindre d'immunosorbant et la résonance plasmonique de surface), des méthodes pharmacologiques, basées sur la fixation des toxines sur leur(s) récepteur(s), et des méthodes passives d'échantillonnage (capture de toxines par adsorption en phase solide).

**Keywords :** Enzyme-linked immunosorbent assay, high performance liquid chromatography, liquid chromatography coupled to mass spectrometry, mouse bioassay, receptor binding assay, solid-phase adsorption toxin tracking, surface plasmon resonance.

---

## Introduction

During the past two decades, the frequency, intensity and geographic distribution of harmful algal bloom have increased along with the number of toxic compounds found in the marine food chain. Evidence is provided from diverse areas that "cultural eutrophication" from domestic, industrial and agricultural wastes can stimulate this phenomenon. Consequently, algal species, which are not normally toxic, may be rendered toxic when exposed to atypical nutrient regimes resulting from cultural eutrophication (FAO, 2004).

Some micro-algal species produce secondary metabolites (phycotoxins) with no explicit role in the metabolism of organisms that produce them. These toxins are accumulated in shellfish, and their consumption results in intoxications and, occasionally, deaths at higher trophic levels. Different clinical types of algae-related poisoning have attracted scientific attention among which diarrhetic shellfish poisoning (DSP), paralytic shellfish poisoning (PSP) and amnesic shellfish poisoning (ASP) are the most frequently encountered (Christian and Luckas, 2008 ; Louppis *et al.*, 2010).

The rapid and reliable detection of phycotoxins and the estimation of their toxicity represent considerable challenges in the context of seafood and public health issues. Actually, a multitude of biological, biochemical and chemical processes permit the identification of most phycotoxins, their classification into chromatographic and non chromatographic analysis being useful for assessing these processes.

The non chromatographic methods, which include immunological and fluorimetric tests, can only determine

toxicity. Highly sensitive chromatographic methods have been developed over the last fifteen years in order to reliably identify individual components of toxins.

### The mouse bioassay (MBA)

The principle of the MBA is based on the comparison of toxicity effects between mouse and human, and also on the appreciation of the time taken by injected mice to die, time of death giving an idea on the amount of toxin present (Ciminiello and Fattorusso, 2004). Toxicity is expressed as mouse units (MU); one MU is defined as the minimum quantity of toxin capable of killing a mouse of 20 g weight within 24 h after intraperitoneal injection (Yasumoto *et al.*, 1980).

At present, the MBA is the reference method for the detection of lipophilic algal toxins, including okadaic acid and related dinophysistoxins (DTXs), pectenotoxins (PTXs), yessotoxins (YTXs) and azaspiracids (AZAs), as well as the cyclic imines gymnodimines (GYMs) and spirolides (SPXs; EU Regulation, 2074/2005). All analytical methods used for this purpose have to be evaluated against bioassays. The MBA was first developed by Yasumoto *et al.* (1978).

Actually, the MBA is the official detection method for all regulated phycotoxins except domoic acid (Vilarío *et al.*, 2010). For PSP monitoring, the procedure was developed more than half a century ago and has been refined and standardized by the Association of Official Analytical Chemists (AOAC) to produce a rapid and reasonable accurate measurement of total PSP toxins.

Because of the low sensitivity and selectivity of the MBA, the growing resistance against the use of animal experiments (Christian and Luckas, 2008), the poor information given by this test on the amount of toxins present in the samples, specially for lipophilic toxins, there is growing acceptance of the need to develop and implement non-animal based methods of toxin detection. Thus, instrumental methods are required to individuate the nature of the involved toxins.

The rapid and reliable detection of phycotoxins and the estimation of their toxicity represent considerable challenges in the context of seafood and public health issues. Many alternative chemical methods have been developed during the last years to monitor these toxins (Stobo *et al.*, 2008; Wang *et al.*, 2007).

### High performance liquid chromatography (HPLC)

The most commonly used method for research application of PSP toxins is the post-column oxidation HPLC method developed by Oshima (1995). This method has not been validated by AOAC nor approved as an NSSP (National Shellfish Sanitation Program, USA) method for regulatory purposes, because it is time consuming since three separate isocratic runs are needed to separate, identify and quantify the range of present toxins.

The Oshima (1995) post-column oxidation method was modified by Thomas *et al.* (2006) and then further by Rourke *et al.* (2008). The major advantages of this latter modified method include higher throughput and faster turn-around time of positive samples (Etheridge *et al.*, 2010).

A successful AOAC single laboratory validation was performed with this method (Rourke *et al.*, 2008), and it is currently the focus of an AOAC collaborative study. Additionally, this post-column HPLC approach was accepted in October 2009 as a Type IV NSSP method for the determination of paralytic shellfish toxins in shellfish, making it the most recently approved PSP method for regulatory purposes in the USA (Etheridge, 2010).

According to Etheridge (2010), only the AOAC Lawrence (2005) method was approved and has been validated for saxitoxin (STX), neosaxitoxin (neoSTX), gonyautoxins 2 and 3 (GTX2/3 together), gonyautoxins 1 and 4 (GTX1/4 together), decarbamoyl saxitoxin (dcSTX), B-1 (GTX5), C-1 and C-2 (C1/2 together), and C-3 and C-4 (C3/4 together) in mussels, clams, oysters and scallops. This pre-column oxidation HPLC technique is becoming more established, especially as a regulatory tool.

In order to gain better knowledge of toxins profiles in shellfish and dinoflagellates samples, Rodríguez *et al.* (2010) made recently a comparative study for analysis of pre- and post-column oxidation methods to detect PSP toxins. In this study, all PSP toxins were individually identified and quantified within the post-column oxidation method. However, although the pre-column oxidation method is significantly more sensitive and detects lower toxin levels, it provides a total amount of toxins that co-elute together, as GTX2 and GTX3, GTX1 and GTX4, and dcGTX2 and dcGTX3. In conclusion, the post-column oxidation method is accurate to determine the amount of each individual PSP toxin and to know the real toxic profile of non-transformed samples. In addition, this method is easy and fast to screen a large number of samples. The pre-column HPLC method is useful when mussel samples are analysed, even if the time required to prepare the samples is longer.

Instrumentation costs and lack of certified reference materials [B-2 (GTX6) and C3/4 being still not available] are the major obstacles of implementation of this method and other analytical methods (Guy and Griffin, 2009).

Officially, the traditional MBA has been the only method adapted for the detection of GYM-A in bivalves, until recently. Because of the low sensitivity and selectivity of this test, the poor information given on the amount present in the samples and the difficulty to quantify this toxin due the fast mortality of animals, many alternative chemical methods have been developed. For this purpose, a new method for extraction, detection and quantification of the GYM-A by HPLC-UV was developed. The selectivity of the extraction protocol, the ability to detect amounts of GYM-A in the nanogram range in biological extracts, the speed of the method (15 min), the recovery rate (96%) and the minimum detection level (5 ng/mL) of this method are well appropriated and assure the reliability of qualitative and quantitative analyses under routine monitoring conditions (Marrouchi *et al.*, 2009).

## Liquid chromatography coupled to mass spectrometry (LC-MS)

The development of the use of LC-MS has progressed rapidly, and an increasing number of scientists consider this method as an effective and viable alternative to the MBA, offering greater selectivity, sensitivity, reliability and rapidity (Fux *et al.*, 2007; Turrell and Stobo, 2007).

Many works have been done during the last years to develop new methods based on LC-MS in order to substitute the MBA. Among these works, a rapid method for the detection of marine toxins was developed using an ultra-performance liquid chromatography (UPLC) system coupled to the latest generation mass spectrometry (MS) system. The analysis of 21 lipophilic marine toxins in a single run was achieved on an Acquity C18 column using a water-acetonitrile gradient with a cycle time of 6.6 min, reducing analysis time by more than 50%, compared to HPLC, while maintaining peak resolution. Linear ranges, limits of detection and limits of quantification were established for okadaic acid, pectenotoxin-2 (PTX-2), azaspiracid-1 (AZA-1), YTX, GYM and 13-desmethyl C SPX (Fux *et al.*, 2007).

Other studies were also interested in lipophilic marine biotoxins such as GYM, SPXs, DTXs, okadaic acid, PTXs, YTXs, and AZAs, in the aim to near real-time analyse these phycotoxins in plankton for studies on bloom dynamics and the fate of toxins in the food web, and to characterize and isolate the putatively toxicogenic organisms (Krock *et al.*, 2008).

Recently, These *et al.* (2009) develop a solid-phase extraction method for the enrichment and clean-up of lipophilic marine biotoxins from extracts of different species of bivalve mollusks and processed shellfish products. Okadaic acid, PTX-2, AZA-1 and YTX were determined by LC-MS/MS in hydrolyzed and non-hydrolyzed extracts.

HPLC with pre-column derivatization and fluorescence detection (Riobó *et al.*, 2006) and LC-MS (Ciminiello *et al.*, 2006) are among the methods used for the determination of palytoxin in cells and shellfish tissues. Recently, a new method, the liquid chromatography coupled to time-of-flight mass spectrometry (LC-TOF-MS), has been set up by Rossi *et al.* (2010) to determine palytoxin in cells and shellfish tissues. This method was tested and proved to be sensitive, and provided a high resolution allowing for the detection of five palytoxin-like compounds.

Ciguatera poisoning poses a significant threat to public health in tropical and sub-tropical regions. The ability to detect and quantify ciguatoxins (CTXs) in suspect fish will support the diagnosis of ciguatera and will lead to a better understanding of the epidemiology of this disease.

A reliable and reproducible liquid chromatography/tandem mass spectrometry (HPLC- MS/MS) method was developed to detect and quantify P-CTX-1 and P-CTX-2 using a rapid methanol extraction and clean-up, with a detection limit of 0.03 mg/kg fish flesh (Stewart *et al.*, 2010).

Yet, high sensitivity, especially for field measurements, is a key issue. The advantage of the LC-MS approach is that it is possible to detect intact, individual underivatized toxins and related compounds in relatively crude extracts (Ciminiello *et al.*, 2002). This technique is also a valuable method to near real-time analyse phycotoxins in plankton for studies on bloom dynamics and the fate of toxins in the food web, and to characterize and isolate the putatively toxicogenic organisms (Krock *et al.*, 2008).

However, internal standards are not currently available for lipophilic marine toxins and thus, an alternative approach must be adopted (Fux *et al.*, 2007). Also, sample preparation procedures still differ between countries. Most world-wide toxin monitoring programs involve typically the extraction of raw shellfish whereas in some countries, *e.g.* Denmark and Germany, the shellfish are mildly cooked by steaming prior to extraction, heat treatment duration having not been harmonized (Fux *et al.*, 2007).

The chromatographic techniques are ones of the best methods for the detection of marine biotoxins but they require expensive equipments, trained personnel, and sophisticated method of sampling preparation. They are also time consuming methods (Mohd Syaifudin *et al.*, 2009) and the information does not offer any insight into the toxicology of the sample (Botana *et al.*, 2009).

## Enzyme-linked immunosorbent assay (ELISA)

Immunoassay techniques are based on the affinity recognition between antibodies and antigens. Isolation of the produced antibodies can be used in enzyme-linked immunosorbent assays (ELISA) in the aim to detect various marine biotoxins (Campas *et al.*, 2007).

For DSP toxins, two ELISA test kits sensitive to okadaic acid were developed. The first is the "DSP-check kit" performed by R- Biopharm (Germany). This assay demonstrated cross reactivity to DTX1 (70%) and DTX2 (40%, Aune *et al.*, 2007) but not to DTX3, PTXs or YTXs, the limit of detection (LOD) being 20 ng/g for okadaic acid. The second assay, "Okadaic acid ELISA Kit" commercialized by Rougier Bio-tech (Canada), has been shown to detect, with equal sensitivity, okadaic acid and derivatives such as the methyl ester, diol ester, DTX4 and DTX5, but not DTX3.

In a recent study, Campbell *et al.* (2009) developed an ELISA for the detection of PSP toxins. The cross-reactivity data demonstrate that this ELISA format is extremely sensitive (in the picogram per mL range) and highly specific for STX with marginal cross-reactivity to GTX5, dcSTX and GTX2/3 and no significant cross-reactivity for all the other PSP toxins analysed. For surface plasmon resonance analysis (see below), the percentage of cross-reactivity in relation to saxitoxin dihydrochloride (STXdiH) varied more compared to the ELISA, with similar trends in specificity but a greater sensitivity of the ELISA for all the analysed toxins.

Actually, commercial ELISA, produced by Abraxis, R-Bio- pharm, and Beacon Analytical Systems Inc., are available. Advantages of these kits include ease of use and high throughput (Etheridge, 2010).

A direct sandwich ELISA, using monoclonal antibodies (mAbs) specific against both ends of Pacific CTXs, was established to detect CTX-3C and 51-hydroxyCTX-3C at the ppb level, with no cross-reactivity against other marine toxins including brevetoxin-A, brevetoxin-B, okadaic acid and maitotoxin (Tsumuraya *et al.*, 2010).

Despite its sensitivity, saving time, costs and animal lives, ELISA is laborious, requires trained personnel and a significant amount of hands-on time (Campbell *et al.*, 2009). In addition, the limit of this test is the identification of only compounds for which the binder was developed (Botana *et al.*, 2009).

The development of ELISA strip and the preparation of samples will need to follow some laboratory procedures and tedious work. Also, there is no guarantee that the ELISA strip will respond very well to all samples (Mohd Syaifudin *et al.*, 2009).

### Surface plasmon resonance (SPR) biosensors

For DSP toxins, another assay format was carried out by Stewart *et al.* (2009): a panel of monodonal antibodies (MAbs) generated to okadaic acid with the aim of developing a surface plasmon resonance (SPR)-based biosensor assay to detect all okadaic acid derivatives. This automated biosensor assay, compared to ELISA, was more efficient in terms of toxin usage and time required for assay, and provided immediate information on antibody binding characteristics.

Biological methods, including use of biosensors, offer interesting possibilities for reduction of the number of bioassays and a very promising future of new developments (Vilarinho *et al.*, 2010).

The biosensor-based assay could be used for preliminary screening of shellfish sample toxicity and, if the sample is considered suspicious, complementary analytical techniques could then be used in parallel to provide a full toxin determination and quantification (Stewart *et al.*, 2009).

The potential for coupling technologies to deliver new, improved forms of bioanalysis is still in its infancy. Marchesini *et al.* (2009) present in their work a number of examples in which coupling has been successful with special emphasis on combining SPR biosensors with MS. In the same time, they develop a new assay to detect PSP toxins, based on the capture of analyte on the chip surface and the elution for further off-line or on-line LC-MS analysis. In contrast, with the inhibition biosensor immunoassay (iBIA) format, the analyte interacting with the biorecognition element is usually discarded to waste.

The iBIA/recovery-chip/nano-hydrophilic interaction chromatography (HILIC)-TOF-MS coupling was achieved for the first time for PSP toxins (dcSTX, STX, GTX1/4, decarbamoyl GTX2/3, GTX2/3, GTX5 and neoSTX) by using a recovery-chip interface, with the biorecognition element immobilized on its surface, able to capture the relevant analytes and that could be re-used. The analytes were further eluted and analysed with nano-HILIC-TOF-MS. PSP toxins were detected in non-compliant samples using this analytical strategy at, and below, the regulatory limits during the screening of mussel and cockle samples (Marchesini *et al.*, 2009). The authors confirm that this analytical approach has great potential for the identification of emerging biotoxins, especially if combined with functional receptors as biorecognition elements. Further research should focus on implementing more robust nano-LC hardware to improve the performance of nano-HILIC-TOF-MS and the possibility of on-line dilution, which will allow an automated transition between the recovery chip and the loop-type interface.

### Receptor binding assay (RBA)

Receptor binding assay (RBA) is a pharmacology-based method, based on toxin affinity for its receptor. It was implemented for detecting PSP toxins by Davio and Fontelo (1984). Later, the assay was further improved by Doucette *et al.* (1997) who transformed it into a microtiter plate-based assay which increased sample throughput and efficiency. The results showed a close agreement between toxicity determined by RBA and MBA. The method was further improved by Powell and Doucette (1999) by using microplate scintillation technology, which resulted in decreasing the assay time to 4 h. Actually, a single laboratory validation of the RBA was successful (Van Dolah *et al.*, 2010), and an AOAC collaborative study is currently in progress. The existing AOAC collaborative study indicates the potential for this method to be fully validated in the near future (Etheridge, 2010) in the aim to detect PSP toxins in mussel extracts. The RBA is highly specific and generally exploit the interactions between toxins and voltage-gated sodium channels. This functional based assay allows toxins to bind to the receptors according to their affinity, yielding an integrated toxic potency.

The detection of a range of toxin congeners was characterized using the RBA. It was found that the rat brain sodium channel preparations, in the assay, reliably represented total toxicity of the congeners present in a sample. The reported binding affinities were, in the decreasing order, STX > GTX1/4 > neoSTX > GTX2/3 > dcSTX > GTX5, which is similar to the order obtained from mouse toxicity (Usup *et al.*, 2004).

The main limitation of widespread implementation of the RBA is the need of radiolabeled material ( $^3\text{H}$ -STX; Etheridge, 2010). However, RBA remains simple, rapid and sufficiently sensitive to be used as a monitoring tool for brevetoxins in shellfish. It is based on brevetoxin affinity for its sodium channel receptor (*i.e.* the site 5 of voltage-gated sodium channels; Plakas and Dickey, 2010).

In its most common format, composite brevetoxins are measured in shellfish tissue extracts based on binding

competition with radiolabeled brevetoxin ( $^3\text{H-PbTx-3}$ ) for receptor sites, using isolated membrane preparations from excitable tissues (Trainer and Poli, 2000) or whole-cell preparations (Bottein-Dechraoui *et al.*, 2007).

RBA was used as a rapid screening tool to quantify domoic acid activity in a selection of Northern Fur Seal samples that were cleaned by solid phase extraction. This filtration assay determines the competitive displacement of a given sample to tritiated kainic acid from a cloned glutamate receptor (Lefebvre *et al.*, 2010).

**Table 1.** Summary of the main characteristics and limits of each method monitoring marine biotoxins.

**Tableau 1.** Résumé des principales caractéristiques et des limites de chaque méthode de surveillance des biotoxines marines.

Methods	Characteristics	Limits
MBA	<ul style="list-style-type: none"> <li>The MBA gives evidence of the toxic potential of a sample.</li> <li>Reference method for the detection of PSP and DSP toxins.</li> </ul>	<ul style="list-style-type: none"> <li>Low sensitivity and selectivity.</li> <li>Interference from other toxic substances.</li> <li>High false-positive rate.</li> <li>Animal ethics.</li> </ul>
HPLC	<ul style="list-style-type: none"> <li>Assure the reliability of qualitative and quantitative analyses.</li> <li>Possibility to detect intact, individual toxins and related compounds in relatively crude extracts.</li> </ul>	<ul style="list-style-type: none"> <li>Require prolonged sample preparation in addition to highly trained personnel.</li> <li>Lack of certified reference materials.</li> <li>Instrumentation costs.</li> </ul>
LC-MS	<ul style="list-style-type: none"> <li>Identification and quantification for most marine biotoxins.</li> <li>Offering greater selectivity, sensitivity, reliability and rapidity.</li> <li>Molecular mass determination and structure elucidation.</li> </ul>	<ul style="list-style-type: none"> <li>Requires expensive equipments, trained personnel and sophisticated method of sampling preparation.</li> <li>It is a time consuming method.</li> <li>Sample preparation procedures still differ between countries.</li> <li>The information does not offer any insight into the toxicology of the sample.</li> </ul>
ELISA	<ul style="list-style-type: none"> <li>An easy-to-use, reliable and inexpensive test.</li> <li>ELISA format is extremely sensitive (in the picogram per mL range) and highly specific for STX.</li> </ul>	<ul style="list-style-type: none"> <li>ELISA assay is laborious, requires trained personnel and a significant amount of hands-on time.</li> <li>It can identify only the compounds for which the binder was developed.</li> <li>There is no guarantee that the ELISA strip will respond very well to all samples.</li> </ul>
RBA	<ul style="list-style-type: none"> <li>Close agreement between toxicity determined by RBA compared to MBA.</li> <li>The RBA is highly specific, simple, rapid and sufficiently sensitive.</li> <li>A rapid screening tool to quantify activity of domoic acid, PSP toxins, cyclic imine group and brevetoxins.</li> </ul>	<ul style="list-style-type: none"> <li>The main limitation of widespread implementation of the RBA to monitor PSP toxins is the need of radiolabeled material (<math>^3\text{H-STX}</math>).</li> <li>Requires specialized equipment and trained personnel.</li> </ul>
SPR	<ul style="list-style-type: none"> <li>Good detection of all PSP toxins and okadaic acid congeners.</li> </ul>	<ul style="list-style-type: none"> <li>Some R1 hydroxylated analogues of PSP toxins that have a lower cross-reactivity are not detected.</li> </ul>
SPATT	<ul style="list-style-type: none"> <li>Detection of marine biotoxins <i>in situ</i>.</li> <li>Passive sampling method.</li> <li>High sensitivity.</li> <li>Good relationships between the abundance of micro-algal and concentration of toxins.</li> </ul>	<ul style="list-style-type: none"> <li>Efficacy evaluation of ciguatera toxins, palytoxin and brevetoxins is required.</li> <li>Suitable adsorption substrates are required for the more polar toxins.</li> </ul>



The cyclic imine group (GYMs and SPXs) constitutes a source of false positives in lipophilic toxin detection by the mouse bioassay. In addition, there is no clear evidence of its toxicity to humans (Vilarino *et al.*, 2009). A reliable assay was recently carried out by Fonfría *et al.* (2010) who described an inhibition assay developed by using fluorescent  $\alpha$ -bungarotoxin and nicotinic acetylcholine receptor-enriched membranes of *Torpedo marmorata* to detect GYM-A and 13-desmethyl C SPX. This test, which is based on the detection of molecular interactions by fluorescence polarization, demonstrates that GYM-A and 13-desmethyl C SPX inhibit, in the nanomolar range, the interaction between  $\alpha$ -bungarotoxin and *Torpedo* nicotinic acetylcholine receptors.

### Solid-phase adsorption toxin tracking (SPATT)

A recent method developed by Mackenzie (2010) describes a new assay to detect lipophilic biotoxins *in situ*. The technique is conceptually similar to other passive sampling methods (Wilson and Wilson, 2007; Bueno *et al.*, 2009) designed to monitor the occurrence of organic pollutants in water and shellfish, such as the semi-permeable membrane devices (SPMD) and polar organic chemical integrative samplers (POICS).

The idea came from the observation that significant amounts of algal biotoxins were dissolved in the seawater when toxic species were present (Paz *et al.*, 2004), which provides a simple means of monitoring that simulated biotoxin contamination of filter feeding bivalves.

The study was a part of the SPIES-DETOX project funded by the European Commission (SPIES-DETOX, 2008) involved the deployment of SPATT bags containing SP700 resin at sites in Scotland, Norway, Ireland Spain and Greece.

Good relationships were observed between the abundance of micro-algal toxin producers and concentrations of okadaic acid, PTX-2, YTXs, SPXs and GYM within the SPATT bags in Alfacs Bay, in the northwest Mediterranean Sea (Mallat *et al.*, 2007). The sensitivity of the method was demonstrated in Nova Scotia (Canada) through the detection of DTXs, PTXs, YTXs, AZAs in SPATT bags whereas these toxins were undetectable in plankton-net tows (Gamett *et al.*, 2006).

Further research is required to evaluate efficacy of the SPATT method for some groups (*e.g.* ciguatera toxins, palytoxins, brevetoxins), and suitable adsorption substrates for the more polar toxins are required (Mackenzie, 2010).

### Conclusion

Additional alternative assays to the standard animal test have been developed but none, until now, were well suited for field use (Laycock *et al.*, 2006). Therefore, the MBA remains the safest option to ensure the safety of marine products and subsequently human health.

**Acknowledgements.** This work was performed in the context of cooperation between universities Franco-Tunisian, funded by the French Ministry of Foreign Affairs and the Tunisian Ministry of Higher Education (Hubert Curien Partnerships - Project No. 08G0903).

### References

- Aune T, Larsen S, Aasen JAB, Rehmann N, Satake M, Hess P (2007) Relative toxicity of dinophysistoxin-2 (DTX-2) compared with okadaic acid base on acute intraperitoneal toxicity in mice. *Toxicon* **49**: 1-7
- AOAC Official Method (2005) 06, A.M, 2005. In *Official Methods of Analysis*
- Botana LM, Alfonso A, Botana A, Vieytes MR, Vale C, Vilarino N, Louzao C (2009) Functional assays for marine toxins as an alternative, high-throughput screening solution to animal tests. *Trends in Analytical Chemistry* **28**: 5
- Bottein-Dechraoui MY, Wang Z, Ramsdell JS (2007) Intrinsic potency of synthetically prepared brevetoxin cysteine metabolites BTX-B2 and desoxyBTX-B2. *Toxicon* **50**: 825-834
- Bueno MJM, Hernando MD, Aguera A, Fernandez-Alba AR (2009) Application of passive sampling devices for screening of micro-pollutants in marine aquaculture using LC-MS/MS. *Talanta* **77**: 1518-1527
- Campas M, Prieto-Simon B, Marty JL (2007) Biosensors to detect marine toxins: assessing seafood safety. *Talanta* **72**: 884-895
- Campbell K, Huet AC, Charlier C, Higgins C, Delahaut P, Elliott ChT (2009) Comparison of ELISA and SPR biosensor technology for the detection of paralytic shellfish poisoning toxins. *J Chromatogr B* **877**: 4079-4089
- Christian, B, Luckas, B (2008) Determination of marine biotoxins relevant for regulations from the mouse bioassay to coupled LC-MS methods. *Anal Bioanal Chem* **391**: 117-134
- Ciminiello P, Dell'Aversano C, Fattorusso E, Forino M, Magno S, Poletti R (2002) Direct detection of yessotoxin and its analogues by liquid chromatography coupled with electrospray ion trap mass spectrometry. *J Chromatogr A* **968**: 61-69
- Ciminiello P, Fattorusso E (2004) Toxins-chemicals studies on northern Adriatic mussels. Micro review. *Eur J Org Chem* **12**: 2533-2551
- Ciminiello P, Dell'Aversano C, Fattorusso E, Forino M, Magno SG, Tartaglione L, Grillo C, Melchiorre N (2006) The Genoa 2005 outbreak. Determination of putative palytoxin in Mediterranean *Ostreopsis ovata* by a new liquid chromatography tandem mass spectrometry method. *Anal Chem* **78**: 6153-6159
- Davio SR, Fontelo PA (1984) A competitive displacement assay to detect saxitoxin and tetrodotoxin. *Anal Biochem* **141**: 199-204
- Doucette GJ, Logan MM, Ramsdell JS, Van Dolah FM (1997) Development and preliminary validation of a microtiter plate-based receptor binding assay for paralytic shellfish poisoning toxins. *Toxicon* **35**: 625-636
- Etheridge SM (2010) Paralytic shellfish poisoning: Sea food safety and human health perspectives. *Toxicon* **56**: 108-122
- FAO marine biotoxins (2004) *Food and nutrition*, paper 80

- Fonfría ES, Vilarino N, Espina B, Louzao CM, Álvarez M, Molgó J, Araújo R, Botana LM (2010) Feasibility of gymnodimine and 13-desmethyl C spirolide detection by fluorescence polarization using a receptor-based assay in shellfish matrices. *Anal Chim Acta* **657**: 75-82
- Fux E, McMillan D, Bire R, Hess P (2007) Development of an ultraperformance liquid chromatography-mass spectrometry method for the detection of lipophilic marine toxins. *J Chromatogr A* **1157**: 273-280
- Garnett CM, Rafuse CM, Lewis NI, Kirchhoff S, Cullen J, Quilliam MA (2006) Monitoring of lipophilic shellfish toxins using SPATT (solid-phase adsorption toxin tracking) in Nova Scotia, Canada. Abstract O.19-02 of the 12<sup>th</sup> International Conference on Harmful Algae, Copenhagen (Denmark), 4-8 September
- Guy A, Griffin G (2009) Adopting alternatives for the regulatory monitoring of shellfish for paralytic shellfish poisoning in Canada: interface between federal regulators, science and ethics. *Regul Toxicol Pharmacol* **54**: 256-263
- Louppis AP, Badeka AV, Katikou P, Paleologos EK, Kontominas MG (2010) Determination of okadaic acid, dinophysistoxin-1 and related esters in Greek mussels using HPLC with fluorometric detection, LC-MS/MS and mouse bioassay. *Toxicon* **55**: 724-733
- Krock B, Tillmann U, John U, Cembella A (2008) LC-MS-MS aboard ship: tandem mass spectrometry in the search for phycotoxins and novel toxigenic plankton from the North Sea. *Anal Bioanal Chem* **392**:797-803
- Laycock MV, Jellett JF, Easy DJ, Donovan MA (2006) First report of a new rapid assay for diarrhetic shellfish poisoning toxins. *Harm Algae* **5**: 74-78
- Lefebvre KA, Robertson A, Frame ER, Colegrove KM, Nance Sh, Baugh KA, Wiedenhof H, Gulland FMD (2010) Clinical signs and histopathology associated with domoic acid poisoning in northern fur seals (*Callorhinus ursinus*) and comparison of toxin detection methods. *Harm Algae* **9**: 374-383
- MacKenzie LA (2010) *In situ* passive solid-phase adsorption of micro-algal biotoxins as a monitoring tool. *Curr Opin Biotech* **21**: 326-331
- Mallat E, Krock B, Fernandez-Tejedor M, Caillaud A, Canete E, Elandaloussi LM, Franco J, Cembella A, Diogene J (2007) First approach towards the implementation of passive sampling adsorption devices for the identification of lipophilic toxins in the coastal embayments of the Ebro Delta. In *Proceedings of the 6th International Conference on Molluscan Shellfish Safety*. Busby P. (ed) pp 336-342. Blenheim New Zealand
- Marchesini GR, Hooijerink H, Haasnoot W, Buijs J, Campbell K, Elliott CT, Nielen MWF (2009) Towards surface plasmon resonance biosensing combined with bioaffinity-assisted nano HILIC Liquid Chromatography/ Time-of-flight Mass Spectrometry identification of Paralytic Shellfish Poisons. *Trends Anal Chem* **28**: 6
- Marrouchi R, Dziri F, Belayouni N, Hamza A, Benoit E, Molgó J, Kharrat R (2009) Quantitative determination of Gymnodimine-A by high performance liquid chromatography in contaminated clams from Tunisia coastline. *Mar. Biotechnol* **12**: 579-585
- Mohd Syaifudin AR, Jayasundera KP, Mukhopadhyay SC (2009) A low cost novel sensing system for detection of dangerous marine biotoxins in seafood. *Sens Act B* **137**: 67-75
- Oshima Y (1995) Post-column derivatization HPLC methods for paralytic shellfish poisons. In *Manual on Harmful Marine Microalgae*. Hallegraeff GM, Anderson DM, Cembella AD (eds) pp 81-94. IOC of UNESCO
- Paz B, Riobo P, Fernandez AL, Fraga S, Franco JM (2004) Production and release of yessotoxins by the dinoflagellates *Protoceratium reticulatum* and *Lingulodinium polyedrum* in culture. *Toxicon* **44**: 251-258
- Plakas SM, Dickey RW (2010) Advances in monitoring and toxicity assessment of brevetoxins in molluscan shellfish. *Toxicon* **56**: 137-149
- Powell CL, Doucette GJ (1999) A receptor binding assay for paralytic shellfish poisoning toxins: recent advances and applications. *Nat Toxins* **7**: 393-400
- Rodríguez P, Alfonso A, Botana AM, Vieytes MR, Botana LM (2010) Comparative analysis of pre- and post-column oxidation methods for detection of paralytic shellfish toxins. *Toxicon* **56**: 448-457
- Riobo P, Paz B, Franco JM (2006) Analysis of palytoxin-like in *Ostreopsis* cultures by liquid chromatography with pre-column derivatization and fluorescence detection. *Anal Chem Acta* **566**: 217-223
- Rossi R, Castellano V, Scalco E, Serpe L, Zingone A, Soprano V (2010) New palytoxin-like molecules in Mediterranean *Ostreopsis cf. ovata* (dinoflagellates) and in *Palythoa tuberculosa* detected by liquid chromatography-electrospray ionization time-of-flight mass spectrometry. *Toxicon in press*
- Rourke WA, Murphy CJ, Pitcher G, van de Riet JM, Burns BG (2008) Rapid post-column methodology for determination of paralytic shellfish toxins in shellfish tissue. *J AOAC Int* **91**: 589-597
- SPIES-DETOX (2008) Active biological monitoring and removal of toxins in aquaculture ecosystems and shellfish—including the development of a Solid-Phase *In situ* Ecosystem Sampler (SPIES) and detoxification of shellfish (DETOX). European Commission Project under the sixth framework (2002-2006) Project No. 0302790-2
- Stewart LD, Elliott Ch T, Walker AD, Curran RM, Connolly L (2009) Development of a monoclonal antibody binding okadaic acid and dinophysistoxins-1, -2 in proportion to their toxicity equivalence factors. *Toxicon* **54**: 491-498
- Stewart I, Eaglesham GK, Poole S, Graham G, Paulo C, Wickramasinghe W, Sadler R, Shaw GR (2010) Establishing a public health analytical service based on chemical methods for detecting and quantifying Pacific ciguatoxin in fish samples. *Toxicon* **56**: 804-812
- Stobo LA, Lacaze JPCL, Scott AC, Petrie J, Turrell EA (2008) Surveillance of algal toxins in shellfish from Scottish waters. *Toxicon* **51**: 635-648
- These A, Scholz J, Preiss-Weigert A (2009) Sensitive method for the determination of lipophilic marine biotoxins in extracts of mussels and processed shellfish by high-performance liquid chromatography-tandem mass spectrometry based on enrichment by solid-phase extraction. *J Chromatogr A* **1216**: 4529-4538
- Thomas K, Chung S, Ku J, Reeves K, Quilliam MA (2006) Analysis of PSP toxins by liquid chromatography with postcolumn oxidation and fluorescence detection. In *Molluscan Shellfish Safety*. Henshilwood K, Deegan B, McMahon T, Cusack C, Keaveney S, Silke J, O'Connide M, Lyons D, Hess P (eds) pp 132-138. The Marine Institute Galway : Ireland
- Trainer VL, Poli MA, (2000) Assays for dinoflagellate toxins, specifically brevetoxin, ciguatoxin, and saxitoxin. In *Animal toxins: facts and protocols*. Rochat H, Martin-Eauclaire MF (eds) pp 1-19. Birkhauser Verlag: Basel, Switzerland
- Tsumuraya T, Fujii I, Hiram M (2010) Production of monoclonal antibodies for sandwich immunoassay detection of Pacific ciguatoxins. *Toxicon* **56**:797-803

- Turrell EA, Stobo L (2007) A comparison of the mouse bioassay with liquid chromatography–mass spectrometry for the detection of lipophilic toxins in shellfish from Scottish waters. *Toxicon* **50**: 442-447
- Usup G, Leaw CP, Cheah MY, Ahmad A, Ng BK (2004) Analysis of paralytic shellfish poisoning toxin congeners by a sodium channel receptor binding assay. *Toxicon* **44**: 37-43
- Van Dolah FM, Leighfield TA, Doucette GJ, Bean L, Niedzwiadek B, Rawn DFK (2010) Single lab validation of the microplate receptor binding assay for paralytic shellfish toxins in shellfish. *J AOAC Int* **in press**
- Vilariño N, Fonfria ES, Molgo J, Araoz R, Botana LM (2009) Detection of Gymnodimine-A and 13-desmethyl C Spirolide phycotoxins by fluorescence polarization. *Anal Chem* **81**: 2708-2714
- Vilariño N, Louzao MC, Vieytes MR, Botana LM (2010) Biological methods for marine toxin detection. *Anal Bioanal Chem* **397**: 1673-1681
- Wang Z, King KL, Ramsdell JS, Doucette GJ (2007) Determination of domoic acid in seawater and phytoplankton by liquid chromatography–tandem mass spectrometry *J Chromatogr A* **1163**: 169-176
- Wilson and Wilson (2007) Comprehensive analytical chemistry. In *Passive Sampling Techniques in Environmental Monitoring*. Greenwood R, Mills G, Vrana B (eds) **48** pp 486. Elsevier
- Yasumoto T, Oshima Y, Yamaguchi M (1978) Occurrence of a new type shellfish poisoning in the Tohoku district. *Bull Jpn Soc Sci Fish* **44**: 1249-1255
- Yasumoto T, Oshima Y, Sugawara W, Fukuyo Y, Oguri H, Igarishi T, Fujita N (1980) Identification of *Dinophysis fortii* as the causative organism of diarrhetic shellfish poisoning. *Bull Jpn Soc Sci Fish* **46**: 1405-1411
-

## **Current situation on receptor-based methods for marine toxins, and comparison with analytical solutions**

Luis M. BOTANA<sup>1\*</sup>, Amparo ALFONSO<sup>1</sup>, M. Carmen LOUZAO<sup>1</sup>, Mercedes R. VIEYTES<sup>2</sup>, Natalia VILARIÑO<sup>1</sup>, Ana M. BOTANA<sup>3</sup>, Carmen VALE<sup>1</sup>

<sup>1</sup> Departamento de Farmacología, <sup>2</sup> Fisiología, Facultad de Veterinaria, <sup>3</sup> Departamento de Química Analítica, Facultad de Ciencias, Campus de Lugo, 27002 Lugo, USC, Spain

\* Corresponding author ; Tel : +34 982 822 233 ; Fax : +34 982 252 242 ; E-mail : Luis.Botana@usc.es

---

### **Abstract**

After the conclusions of the EFSA working group in the CONTAM panel, marine toxins are classified based on their mechanism of action. The use of their mechanism of action is the most adequate approach to develop functional methods, using their receptors as tools to quantify toxin levels. Receptor-based methods provide toxic values, with no profile of individual analogs but require only one standard per group. Fluorescence, absorbance or biosensor methods are the technologies of choice. On the other hand, analytical methods provide toxin profiles, but need standards, and information of toxic equivalent factors. Liquid chromatography with mass detection would be the method of choice for marine toxins. With any approach, results must be proven to be validated among laboratories.

### **Situation actuelle sur les méthodes basées sur les récepteurs pour les toxines marines, et comparaison avec des solutions analytiques**

Suite aux conclusions du groupe de travail EFSA issu du panel CONTAM, les toxines marines sont classées en fonction de leur mode d'action. L'utilisation du mécanisme d'action d'une toxine donnée est le critère le plus adéquat pour développer une méthodologie fonctionnelle, par quantification de la teneur en toxine à partir de son récepteur. Les méthodes basées sur le récepteur fournissent une évaluation de la toxicité, sans profil des analogues individuels, mais ne requièrent qu'un standard par famille. Les méthodes de fluorescence, d'absorbance ou de bio-senseurs sont les mieux adaptées. Les méthodes analytiques fournissent un profil toxinique mais nécessitent des standards ainsi qu'une connaissance des facteurs toxiques équivalents. La chromatographie en phase liquide couplée à la spectrométrie de masse apparaît comme la méthode la plus adéquate pour les toxines marines. Quelle que soit l'approche, les résultats doivent être validés par les laboratoires.

**Keywords :** Chromatography, detection, functional method, marine toxins, toxicity.

---

## **Introduction**

Phycotoxins are produced by about 100 different species of dinoflagellates and diatoms that accumulate in filter-feeding bivalves and fish. Marine toxins are an old known problem to shellfish consumers, because they accumulate very quickly large amount of toxins in their body as a consequence of their filter-feeding of dinoflagellates and diatoms. Therefore, ingestion of shellfish with marine toxins is an acute risk and causes many intoxications worldwide every year. Producer and importer countries have therefore implemented a monitoring system that allows the early detection of toxins before the product is placed on the market. Until now, this monitoring system has been based on the use of the mouse bioassay (Commission, 2005). The requirement set by the European Commission to replace the use of animals (Directive 86/609, 1986), and the pressure to reduce the use of animals has prompted the creation of a working group under the EFSA COMTAM panel, that has evaluated for the past four years (2007-2010) the current state of the art of marine toxins knowledge, including detection and toxicology. As a consequence, a series of opinions was published covering all the toxin groups that address a potential problem to Europe (Panel, 2008b, 2008c, 2008d, 2009b, 2009c, 2009d, 2009e, 2010a, 2010b).

The working group also elaborated a summary on regulated marine toxins (Panel, 2009a), a study on the influence of processing on the levels of lipophilic marine toxins (Panel, 2008a), and a statement on the consumption figure of 400 g for legislative purposes (Panel, 2010c). The conclusions of the four year working group can be summarized as shown in *Table 1*. Additionally, the panel confirmed the general feeling of the scientific community that the term "lipophilic" as it is used in the legislation (Commission, 2005) is not

adequate for the classification of marine toxins, and therefore the toxin groups should be identified by their mechanism of action. This is important for the purposes of this chapter, as the mechanism of action is the only aspect that the compounds in each toxin group have in common. Although some of them are quite similar from a chemical point of view, in some cases the diversity of structures is rather large, as observed in the case of palytoxins (Katikou, 2007), ciguatoxins (Guzmá-Pérez and Park, 2000), or cyclic imines (Molgó *et al.*, 2007). Therefore, for classification purposes the mechanism of action is the best approach to identify toxin groups.

**Table 1.** Conclusions of the EFSA working group in the CONTAM panel.

**Tableau 1.** Conclusions du groupe de travail de l'EFSA dans le panneau CONTAM.

Bioassay	LC-MS	Functional method	Consumption figure
Not adequate	Yes (if validated)	Yes (if validated)	400 g

## Receptor mechanisms of marine toxins

Palytoxins and ostreocins are blockers of the Na<sup>+</sup>-K<sup>+</sup> ATPase (Tosteson *et al.*, 2003), okadaic acid and dinophysistoxins inhibit the protein phosphatases 1 and 2A (Haystead *et al.*, 1989), saxitoxin, tetrodotoxin and analogs are inhibitors of the voltage-dependent sodium channel (Catterall and Morrow, 1978), azaspiracids and yessotoxins have not been linked to a specific receptor, although several mechanisms have been proposed (Alfonso and Alfonso, 2007; Vilarino, 2007), domoic acid activates the kainate receptor (Pulido, 2008), ciguatoxins activate sodium channels (Strachan *et al.*, 1999) and block potassium channels (Schlumberger *et al.*, 2009), pectenotoxins inhibit actin polymerization (Allingham *et al.*, 2007), and cyclic imines are blockers of the nicotinic receptor (Bourne *et al.*, 2010), maitotoxin activates calcium entry through an undefined receptor (Takahashi *et al.*, 1982), and brevetoxins are activators of sodium channel at site 5, with less potency than ciguatera (Huang *et al.*, 1984).

## Receptor-based methods

Receptor-based methods are usually named functional methods, that show the receptor functionality, which is common to any toxin that share a mechanism of action through the same receptor. This philosophy provides two major advantages. First, the need of only one standard, usually the reference compound of the group (*i.e.* okadaic acid for diarrhetic toxins), to calibrate the response and quantify the amount of toxins. Second, the ability of detecting any compound, even if previously unknown, that uses the mechanism of action of the group. The response of the method is linked to its toxicity, since it is carried out through the use of the receptor. On the other hand, given the wide capability for the receptor-based system, the method cannot identify individual compounds, but only an equivalent activity to the calibration standard being used.

The use of receptors to monitor the presence of toxins has been proposed for most of the toxins, and there are many approaches being published. Most of the methods use fluorescence detection (Vieytes *et al.*, 1997), fluorescence polarization (Alfonso *et al.*, 2005; Vilarino *et al.*, 2009b), colorimetric methods (Espina *et al.*, 2009; Tubaro *et al.*, 1996), or biosensors (Fonfria *et al.*, 2008; Vilarino *et al.*, 2009a; Vilarino *et al.*, 2010). The use of antibodies instead of receptors is feasible only in those cases where cross-reactivity covers the whole spectrum of compounds in the group, and matches the toxicity of each of the compounds (Stewart *et al.*, 2009); given the complexity of this approach, it is difficult that it may replace receptor-based methods.

## Analytical methods

Analytical methods, usually liquid chromatography with ultraviolet detection (for domoic acid (Lawrence *et al.*, 1991)) or liquid chromatography with mass spectrophotometric detection (for all other lipophilic toxins (Hess *et al.*, 2009; Stobo *et al.*, 2005)), are well suited to identify the single compounds contained in a sample, but they have two major problems. One is the lack of information of the analysis with the toxicity of the sample and, therefore, a large concentration of a single compound may be provided by a non active analog. The second is the need of proper standards for each of the compound to be identified, and this creates another problem, which is that only toxins being looked for are found, hence any new, unexpected, or unknown compound will remain unidentified by the analysis. The lack of toxicological information in the analysis can be corrected by applying the toxic equivalency factor (TEF), but this is a question that is far from being solved. For a review on the problem of TEF, see (Botana *et al.*, 2010).

## References

- Alfonso A, Alfonso C (2007) Pharmacology of Yessotoxin. In *Phytotoxins, chemistry and Biochemistry*, Botana LM (ed) pp 203-210. Ames, Iowa: Blackwell Publishing
- Alfonso C, Alfonso A, Vieytes MR, Yasumoto T, Botana LM (2005) Quantification of yessotoxin using the fluorescence polarization technique and study of the adequate extraction procedure. *Anal Biochem* **344**: 266-274
- Allingham JS, Miles CO, Rayment I (2007) A structural basis for regulation of actin polymerization by pectenotoxins. *J Mol Biol* **371**: 959-970

- Botana LM, Vilariño N, Elliott CT, Campbell K, Alfonso A, Vale C, Louzao MC, Botana AM (2010) The problem of toxicity equivalent factors in developing alternative methods to animal bioassays for marine toxin detection. *Trends Anal Chem*, in press
- Bourne Y, Radic Z, Araoz R, Talley TT, Benoit E, Servent D, Taylor P, Molgó J, Marchot P (2010) Structural determinants in phycotoxins and AChBP conferring high affinity binding and nicotinic AChR antagonism. *Proc Natl Acad Sci USA* **107**: 6076-6081
- Catterall WA, Morrow CS (1978) Binding to saxitoxin to electrically excitable neuroblastoma cells. *Proc Natl Acad Sci USA* **75**: 218-222
- Commission Regulation (EC) No 2074/2005. *Official Journal of the European Union* **L 338**: 27-59
- Espina B, Cagide E, Louzao MC, Fernandez MM, Vieytes MR, Katikou P, Villar A, Jaen D, Maman L, Botana LM (2009) Specific and dynamic detection of palytoxins by in vitro microplate assay with human neuroblastoma cells. *Biosci Rep* **29**: 13-23
- Fonfria ES, Vilarino N, Vieytes MR, Yasumoto T, Botana LM (2008) Feasibility of using a surface plasmon resonance-based biosensor to detect and quantify yessotoxin. *Anal Chim Acta* **617**: 167-170
- Guzmán-Pérez SE, Park DL (2000) Ciguatera toxins: chemistry and detection. In *Seafood and freshwater toxins: pharmacology, physiology and detection*, Botana LM (ed) pp 401-418. New York: Marcel Dekker
- Haystead TA, Sim AT, Carling D, Honnor RC, Tsukitani Y, Cohen P, Hardie DG (1989) Effects of the tumour promoter okadaic acid on intracellular protein phosphorylation and metabolism. *Nature* **337**: 78-81
- Hess P, Butter T, Petersen A, Silke J, McMahon T (2009) Performance of the EU-harmonised mouse bioassay for lipophilic toxins for the detection of azaspiracids in naturally contaminated mussel (*Mytilus edulis*) hepatopancreas tissue homogenates characterised by liquid chromatography coupled to tandem mass spectrometry. *Toxicon* **53**: 713-722
- Huang JM, Wu CH, Baden DG (1984) Depolarizing action of a red-tide dinoflagellate brevetoxin on axonal membranes. *J Pharmacol Exp Ther* **229**: 615-621
- Katikou P (2007) The chemistry of palytoxins and ostreocins. In *Phytotoxins, chemistry and Biochemistry*, Botana LM (ed) pp 75-94. Ames, Iowa: Blackwell Publishing
- Lawrence JF, Charbonneau CF, Menard C (1991) Liquid chromatographic determination of domoic acid in mussels, using AOAC paralytic shellfish poison extraction procedure: collaborative study. *J Assoc Off Anal Chem* **74**: 68-72
- Molgó J, Girard E, Benoit E (2007) The cyclic imines: an insight into this emerging group of bioactive marine toxins. In *Phytotoxins, chemistry and Biochemistry*, Botana LM (ed) pp 319-335. Ames, Iowa: Blackwell Publishing
- Panel EC (2008a) Influence of processing on the levels of lipophilic marine biotoxins in bivalve molluscs. Statement of the Panel on Contaminants in the Food Chain. *The EFSA Journal* **1016**: 1-10
- Panel EC (2008b) Opinion of the Scientific Panel on Contaminants in the Food chain on a request from the European Commission on marine biotoxins in shellfish – azaspiracids. *The EFSA Journal* **723**: 1-52
- Panel EC (2008c) Opinion of the Scientific Panel on Contaminants in the Food chain on a request from the European Commission on marine biotoxins in shellfish – okadaic acid and analogues. *The EFSA Journal* **589**: 1-62
- Panel EC (2008d) Scientific Opinion on marine biotoxins in shellfish - Yessotoxin group. EFSA Panel on Contaminants in the Food Chain (CONTAM). *The EFSA Journal* **907**: 1-62
- Panel EC (2009a) Marine toxins in shellfish. Summary on regulated marine biotoxins. Scientific Opinion of the Panel on Contaminants in the Food chain. *The EFSA Journal* **1306**: 1-23
- Panel EC (2009b) Opinion of the Scientific Panel on Contaminants in the Food chain on a request from the European Commission on marine biotoxins in shellfish – Saxitoxin group. *The EFSA Journal* **1019**: 1-76
- Panel EC (2009c) Scientific Opinion on marine biotoxins in shellfish - Domoic acid. EFSA Panel on Contaminants in the Food Chain (CONTAM). *The EFSA Journal* **1181**: 1-61
- Panel EC (2009d) Scientific Opinion on marine biotoxins in shellfish - Palytoxin group. EFSA Panel on Contaminants in the Food Chain (CONTAM). *The EFSA Journal* **7**: 1338-1393
- Panel EC (2009e) Scientific Opinion on marine biotoxins in shellfish - Pectenotoxin group. EFSA Panel on Contaminants in the Food Chain (CONTAM). *The EFSA Journal* **1109**: 1-47
- Panel EC (2010a) Scientific Opinion on marine biotoxins in shellfish - Cyclic imines (spirolides, gymnodimines, pinnatoxins and pteriatoxins). EFSA Panel on Contaminants in the Food Chain (CONTAM). *The EFSA Journal* **8**: 1628-1639
- Panel EC (2010b) Scientific Opinion on marine biotoxins in shellfish - Emerging toxins: Ciguatoxin-group toxins. EFSA Panel on Contaminants in the Food Chain. *The EFSA Journal* **8**: 1627-1638
- Panel EC (2010c) Statement on further elaboration of the consumption figure of 400 g shellfish meat on the basis of new consumption data. EFSA Panel on Contaminants in the Food Chain (CONTAM). *The EFSA Journal* **8**: 1706-1720
- Pulido OM (2008) Domoic acid toxicologic pathology: a review. *Mar Drugs* **6**: 180-219
- Schlumberger S, Mattei C, Molgó J, Benoit E (2009) Dual action of a dinoflagellate-derived precursor of Pacific ciguatoxins (P-CTX-4B) on voltage-dependent K(+) and Na(+) channels of single myelinated axons. *Toxicon* **56**: 768-775
- Stewart LD, Hess P, Connolly L, Elliott CT (2009) Development and single-laboratory validation of a pseudofunctional biosensor immunoassay for the detection of the okadaic acid group of toxins. *Anal Chem* **81**: 10208-10214
- Stobo LA, Lacaze JP, Scott AC, Gallacher S, Smith EA, Quilliam MA (2005) Liquid chromatography with mass spectrometry-detection of lipophilic shellfish toxins. *J AOAC Int* **88**: 1371-1382
- Strachan LC, Lewis RJ, Nicholson GM (1999) Differential actions of pacific ciguatoxin-1 on sodium channel subtypes in mammalian sensory neurons. *J Pharmacol Exp Ther* **288**: 379-388
- Takahashi M, Ohizumi Y, Yasumoto T (1982) Maitotoxin, a Ca<sup>2+</sup> channel activator candidate. *J Biol Chem* **257**: 7287-7289
- Tosteson MT, Thomas J, Arnadottir J, Tosteson DC (2003) Effects of palytoxin on cation occlusion and phosphorylation of the (Na<sup>+</sup>,K<sup>+</sup>)-ATPase. *J Membr Biol* **192**: 181-189

- Tubaro A, Florio C, Luxich E, Sosa S, Della Loggia R, Yasumoto T (1996) A protein phosphatase 2A inhibition assay for a fast and sensitive assessment of okadaic acid contamination in mussels. *Toxicon* **34**: 743-752
- Vieytes MR, Fontal OI, Leira F, Baptista de Sousa JM, Botana LM (1997) A fluorescent microplate assay for diarrheic shellfish toxins. *Anal Biochem* **248**: 258-264
- Vilarino N, Fonfría E, Louzao MC, Botana LM (2009a) Use of biosensors as alternatives to current regulatory methods for marine biotoxins. *Sensors* **9**: 9414-9443
- Vilarino N, Fonfría ES, Molgó J, Araoz R, Botana LM (2009b) Detection of gymnodimine-A and 13-desmethyl C spirolide phycotoxins by fluorescence polarization. *Anal Chem* **81**: 2708-2714
- Vilariño N (2007) Biochemistry of azaspiracid poisoning toxins. In *Phytotoxins, chemistry and Biochemistry*, Botana LM (ed) pp 311-318. Ames, Iowa: Blackwell Publishing
- Vilariño N, Louzao MC, Vieytes MR, Botana LM (2010) Biological methods on marine toxin detection. *Anal Bioanal Chem* **397**: 1673-1681
-

## ***New tools to discover active molecules in venoms : from theory to practice***

Philippe FAVREAU<sup>1\*</sup>, Estelle NEVEU<sup>2</sup>, Milena MAVER<sup>2</sup>, Reto STÖCKLIN<sup>1</sup>,  
Daniel BERTRAND<sup>2</sup>

<sup>1</sup> Atheris Laboratories, case postale 314, CH-1233 Bernex, Geneva, Switzerland ; <sup>2</sup> HIQScreen Sàrl, 15, rue de l'Athénée, 1206 Geneva, Switzerland

\* Corresponding author ; Tel : +41 (0)22 850 05 85 ; Fax : +41 (0)22 850 05 86 ;  
E-mail : [philippe.favreau@atheris.ch](mailto:philippe.favreau@atheris.ch)

---

### **Abstract**

*The use of venoms and toxins constitutes the basis for the pharmacological approaches of many biological systems. Although development of small chemical molecules proved very efficient for the finding of compounds of therapeutic values it is becoming clearer that molecules of biological origin may still offer significant advantages. In this regard, venoms can be considered as large libraries of natural compounds and could provide new therapeutic avenues. Identification of bioactive ingredients from venoms that often contain a thousand or more constituents represents, however, a technical challenge for their separation and functional characterization. In this work we discuss, in the light of the latest technological developments, the possibilities of automated electrophysiological characterization of fractions isolated from animal venoms. To illustrate the feasibility of these novel technologies, we analyzed the properties of samples isolated from a spider venom available only in restricted amount, unveiling a specific activity at the human  $\alpha 7$  nicotinic acetylcholine receptor. These data highlight the expended possibilities of nowadays technologies, which open new avenues in the domain of drug discovery.*

### **Nouveaux outils pour la découverte de molécules actives dans les venins : de la théorie à la pratique**

*L'utilisation des venins et toxines constitue la base pour les approches pharmacologiques de nombreux systèmes biologiques. Bien que le développement de petites molécules chimiques reste très efficace pour la découverte de composés thérapeutiques, il est de plus en plus clair que les molécules d'origine biologique offrent des avantages significatifs. À cet égard, les venins peuvent être considérés comme de grandes bibliothèques de composés naturels et pourraient fournir de nouvelles molécules thérapeutiques. L'identification d'ingrédients actifs de venins qui contiennent des centaines de composés représente toutefois un défi technique à la fois en termes de séparation et de caractérisation fonctionnelle. Dans ce travail, à la lumière des derniers développements technologiques nous discutons les possibilités de caractérisation électrophysiologique automatisée de fractions isolées de venins animaux. Pour illustrer la faisabilité de ces nouvelles technologies, des fractions isolées d'un venin d'araignée, disponible uniquement en quantité limitée, ont été analysées et ont permis de mettre en évidence une activité sur le récepteur nicotinique de l'acétylcholine  $\alpha 7$  humain. Ces données mettent en évidence les possibilités des technologies actuelles, ouvrant de nombreuses voies dans le domaine de la découverte de médicaments.*

**Keywords :** *Automated electrophysiology, drug discovery, high-throughput screening, venoms.*

---

## **Introduction**

Peptides and miniproteins from venoms display attractive pharmacological properties useful for research and drug development. A number of lead compounds currently in clinical trials or in preclinical development are derived from venoms and five venom-derived drugs have already reached the market (Fox and Serrano, 2007; Lewis and Garcia, 2003; Stöcklin and Vorherr, 2010). The number of natural biological compounds obtained from venom glands is expected to increase as only a minor portion of existing venoms has been investigated to date.

Venom components are typically classified according to their structural scaffold and/or pharmacological target. Besides low-mass organic compounds, linear peptides and large proteins, the so-called mini-proteins are without doubt the most fascinating and promising venom bioactive components. Mini-proteins usually range from 15 to 80 amino acid residues and exhibit one to five disulfide bonds. They are extremely resistant to



proteases, and by contrast to therapeutic proteins and antibodies, they are poorly immunogenic. In addition, these mini-proteins offer high potency (Kd's in the nM or pM range) and selectivity towards important pharmaceutical targets, *e.g.* ion channel sub-types, receptors, transporters, enzymes or microorganisms.

Toxins and venoms have been used since the beginning of physiological studies to characterize the properties of chemical neurotransmission. For example, the French physiologist Claude Bernard (1857), using curare, a plant extract used by South American Indians, was able to demonstrate for the first time the nature of a chemical neurotransmission at the neuromuscular junction.

The use of snake toxin, such as  $\alpha$ -bungarotoxin from *Bungarus multincintus*, marked another corner stone in our understanding of the endplate neurotransmission allowing the purification of the nicotinic acetylcholine receptor (nAChR) (Changeux *et al.*, 1992). Since then, multiple toxins were identified from different venomous animals providing unique tools for the characterization of ion channels. Determination of the three dimensional structure of  $\alpha$ -bungarotoxin revealed a three-fingers arrangement and it was shown that the disposition of five disulfide bridges are critical for the high affinity binding and slow koff (Servent *et al.*, 1997). Although it is easily understandable that three-fingered toxins are found throughout a large number of snake species and that such toxins were probably selected for prey catching, the discovery of the lynx1 peptide sharing a putative similar three-fingered structure in mammalian brain generated at first a certain skepticism (Miwa *et al.*, 1999). The subsequent characterization of this GPI-anchored protein revealed further surprising properties with the modulation of neuronal nAChRs. More recently, the production of transgenic animals in which the gene encoding for lynx1 has been knocked-out provided new tools to examine the function of this protein on the brain network properties. The discovery of another three-fingered protein, SLURP-1, which is secreted by keratinocytes in the human skin, further opened new challenges to understand in deeper details the role of toxin-like molecules (Chimienti *et al.*, 2003).

However, studies of these peptides from snake venoms or furthermore from endogenously expressed proteins remains limited, due to the small available amounts of properly folded proteins. This is best understood when recalling that three-fingered proteins, such as  $\alpha$ -bungarotoxin, result from the assembly of 74 amino acids and that production in bacteria often yields proteins with inadequate folding. Improper folding causes major changes in the biological activities as it was well documented for the small peptides conotoxins, which can have multiple conformations such as ribbon or globular showing differential pharmacology (Grishin *et al.*, 2010). Additionally, venom quantity can be an issue, especially for very small and/or rare venomous species. In this case, specific analytical and characterization tools such as mass spectrometry coupled to dedicated bioinformatics databases and tools should be used. Such innovative "structure-driven" and "bioinformatics-assisted" steps represent a must to boost conventional "bioactivity-guided" drug discovery strategies (Favreau and Stöcklin, 2009). The recent development of a multitude of mass spectrometers now offers the biochemist extremely powerful solutions for rapid peptide and miniprotein characterization at the sub-microgram level.

The hit discovery process is usually driven by the choice of a molecular target, inferred from a desired pharmacological activity. This can be achieved by many means including electrophysiological, binding or imaging experiments. Particular key parameters such as venom complexity, quantity and test sensitivity are of crucial importance. Venoms contain hundreds of compounds that need to be separated before their biological activity can be tested. If not, the whole venom may mask, interfere or destruct the biological assay thus covering a potential activity from a single isolated compound. A direct consequence of venom separation is the increase in the number of fractions to be assessed, implying that high-throughput testing be used. The biological assay should also be designed to exert high sensitivity and use the lowest amount of venom fraction.

The cell membrane constitutes one of the fundamental constituents of any living organism separating the intracellular compartment from the extracellular fluid. Proteins inserted into the cell wall determine the biophysical properties of the membrane allowing exchange of ions, transport of nutrient etc. Measurement of the electrical properties of the cell membrane by electrophysiological techniques represents one of the most powerful approaches for studying living cell activity and determining membrane protein function or dysfunction. Good examples are provided by the measurement of the electrical activity of muscle cells or neurons and studies of the communications at chemical or electrical synapses. Given the extremely important role of membrane proteins it is not surprising to observe that many drugs currently available exert their action by a direct or indirect interaction with integral membrane proteins. Similarly, side effects of several compounds of clinical interest are caused by the undesired interaction with membrane proteins.

Best measurements of single cell activity require the use of the voltage-clamp technique that consists in measuring the amount of current flowing through the membrane at a given holding potential. While nowadays studies of single cell activity are mainly carried out using the technique of whole cell patch-clamp, these measurements are technically demanding and use of automated devices such as IonWorks (from Molecular Devices), QPatch (Sophion) etc. is restricted to cell lines expressing the proteins of interest. As an alternative, expression of genes is readily obtained in *Xenopus* oocytes using either the technique of mRNA or cDNA expression (Bertrand *et al.*, 1991). Most integral membrane proteins have been successfully expressed and characterized in *Xenopus* oocytes whereas expression in cell lines required tedious selection of a proper clone. Other important advantages of *Xenopus* oocytes are their size, robustness, and limited presence of endogenous membrane proteins and faithful expression of genes of interest. Finally, given their size, *Xenopus* oocytes are readily amenable to automated recordings as illustrated by a few systems such as the Robocyte (MCS), the OPUSpress (initially developed by Axon instrument) or POET (Parallel Oocyte Electrophysiology Test)

(Trumbull *et al.*, 2003). Although impressive data have been obtained with POET with its unique multiplexed approach of recordings and stimulation, the use of this automate is restricted by the availability of the compound of interest. Typically, a single measurement requires about 60  $\mu\text{L}$  of compound, which are deposited in the superfusion bath and aspirated in the waste following the recording. While the first data set obtained with SLURP-1 were recorded using POET, it was clear that this system was impractical for further characterization of this protein available only in very small amounts. Similarly, although automated electrophysiological techniques open the possibility to explore large number of samples their use is restricted by the amount of substance required for the characterization.

In this work we examine a novel technical approach allowing measurements of a biological activity using electrophysiological measurements in a small volume and non-destructive manner. Thus, the sample of interest can be used for multiple measurements without significant alteration of its content.

## Results

To remove the limitation of current electrophysiological methods, we developed a novel concept combining automation of electrophysiological recordings and preservation of the biological sample. The uniqueness of this system resides in the fact that samples are placed in a 96-well microtiter plate that is moved by an x-y-z table while performing the recording. Drug application is done by immersion of the oocyte in the well containing the compound of interest. While a typical sample amount used for characterization is 230  $\mu\text{L}$ , the sample can be measured several times with the same or a different preparation.

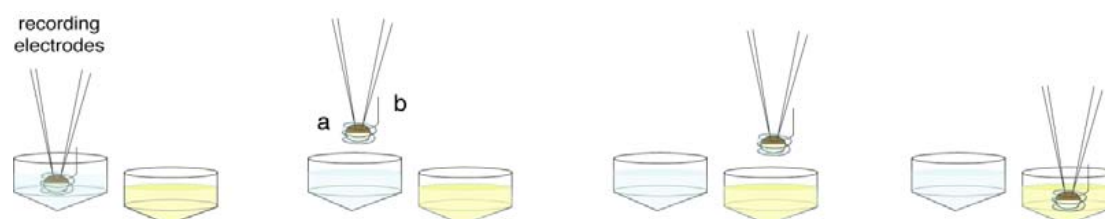

**Figure 1.** Principle of a novel technology for electrophysiological investigations. The oocyte (a) is placed in a small basket (b) that also constitutes the ground electrodes. Samples placed in a 96-well microtiter plate are moved by an x-y-z table while performing the recording. Drug application is done by immersion of the oocyte in the well containing the compound of interest. While a typical sample amount used for characterization is 230  $\mu\text{L}$ , the sample can be measured several times with the same or a different preparation.

**Figure 1.** Principe d'une nouvelle technologie pour les expériences électrophysiologiques. L'oocyte (a) est placé dans un petit panier (b) qui constitue aussi les électrodes de masse. Les échantillons placés dans une plaque de microtitration à 96-puits sont déplacés par une table x-y-z pendant l'expérience. Chaque mesure se fait par immersion de l'oocyte dans le puits contenant le composé d'intérêt. Le volume typique de chaque puits est de 230  $\mu\text{L}$  et chaque puits peut-être testé plusieurs fois sur le même oocyte ou sur une préparation différente.

Full automation of this novel and non-destructive technique opens the possibility of performing electrophysiological testing, in an unattended manner, on a large number of samples. Combining this approach with previously established methods of separation and characterization of toxins allows one, for the first time, to characterize the same venom fractions against several target receptors. Evaluation of a significant number of fractions (100 or more) requires an efficient experimental protocol that can reveal effects of a given sample in a single measurement (see *Figure 2*).

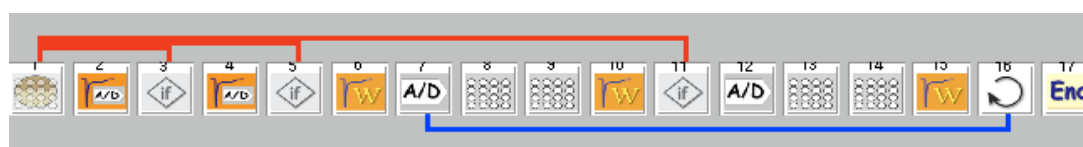

**Figure 2.** Experimental protocol designed for compound testing. In steps 1-3 the oocyte is taken from the storage well, poked and its leak current is monitored. Oocytes displaying a leak current superior to the desired criteria are automatically replaced. Control response to acetylcholine (ACh, 100  $\mu\text{M}$ ) is then determined in steps 7-10. If the response is below the desired amplitude (400 nA) the oocyte is automatically discarded and replaced by a new responding cell (step 11). The oocyte is then immersed for the desired time (30 s) into the sample fraction (step 13) and its response to ACh (same concentration as previously) is measured immediately afterward, at step 14. The oocyte is then rinsed with a control solution (2 min, step 15) and the process is repeated in loop for the next compounds (back to step 7).

**Figure 2.** Protocole expérimental conçu pour les tests des composés. Aux étapes 1-3, l'oocyte est prélevé dans le puits de stockage, piqué et son courant de fuite est contrôlé. Les oocytes présentant une fuite de courant supérieure aux critères souhaités sont automatiquement remplacés. La réponse contrôle à l'acétylcholine (ACh, 100  $\mu\text{M}$ ) est alors déterminée dans les étapes 7-10. Si la réponse est en deçà de l'amplitude désirée (400 nA) l'oocyte est automatiquement éliminé et remplacé par une nouvelle cellule (étape 11). L'oocyte est ensuite exposé pendant le temps désiré (30 s) à la fraction de l'échantillon (étape 13) et sa réponse à l'ACh (même concentration qu'auparavant) est testée immédiatement après, à l'étape 14. L'oocyte est finalement rincé avec une solution contrôle (2 min, étape 15) et le processus est répété en boucle pour chaque puits (retour à l'étape 7).

Typical results obtained with a sample causing inhibition of the  $\alpha 7$  nAChR are illustrated in *Figure 3*.

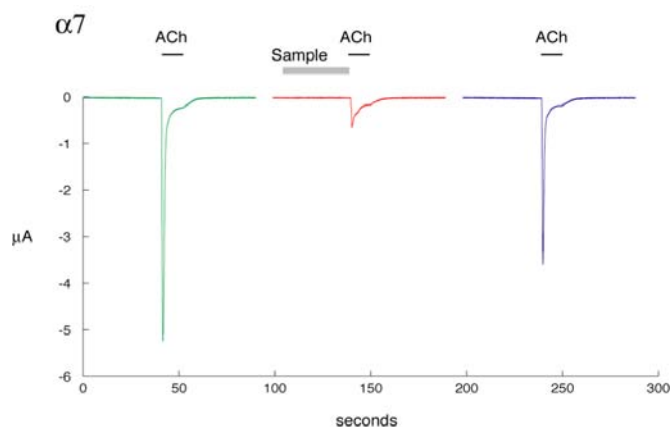

**Figure 3.** Inhibitory effect of a sample at the human  $\alpha 7$  nAChR in response to acetylcholine. The ACh response recorded as a control is shown in green. The fast and transient inward current of robust amplitude ( $> 5 \mu\text{A}$ ) is typical of the  $\alpha 7$  nAChR. Following a 30 s exposure to the test sample the current evoked by the same ACh test pulse is markedly reduced (red trace). A 90 s wash was sufficient to significantly remove the blockade (blue trace).

**Figure 3.** Effet inhibiteur d'un échantillon sur le récepteur nicotinique  $\alpha 7$  humain en réponse à l'acétylcholine. La réponse contrôle à l'ACh est tracée en vert. Un courant entrant rapide et transitoire avec une bonne amplitude ( $> 5 \mu\text{A}$ ) est typique du récepteur  $\alpha 7$ . Après 30 s d'exposition à l'échantillon test, le courant de réponse à l'ACh est réduit de manière significative (tracé rouge). Après un lavage de 90 s, un retour significatif à une réponse normale est observé (tracé bleu).

Results obtained with the same experimental protocol but for an agonist compound that activates the nAChR are illustrated in *Figure 4*.

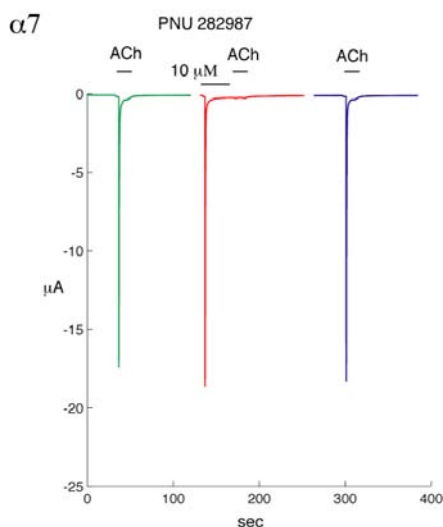

**Figure 4.** Agonistic activity detected by the single exposure experimental protocol. The  $\alpha 7$  agonist PNU-282987 was used as a reference compound for this experiment. Note the brisk inward current observed at the onset of exposure followed by a complete desensitization of the receptor and absence of ACh-evoked current immediately following PNU-282987 (red trace). A 1 min wash proved sufficient to fully recover the amplitude of response at the next ACh test pulse (blue trace).

**Figure 4.** Activité agoniste détectée par le protocole de mesure unique. L'agoniste  $\alpha 7$  PNU-282987 est utilisé comme composé de référence. Un courant entrant est observé dès l'exposition de l'oocyte au contrôle, suivi d'une complète désensibilisation en réponse à l'application d'ACh immédiatement après. Un lavage de 1 min suffit à retrouver une réponse normale à l'ACh (trace bleue).

Main advantages of this experimental protocol are: first, its capacity to determine multiple effects of a compound in a single exposure and second, the fast turnaround time for measurements. Although reducing time interval between measurements is not relevant for the testing of a few samples this becomes critical for large number of samples. For example, determination of the effects of 88 samples requires about 320 min, a time that corresponds to nearly 6 h when taking into account the whole procedure. Although a long experimental protocol can easily be performed with an automated system, some considerations, such as the stability of the sample and evaporation of the liquid in the microtiter plate, must be kept in mind when designing the experiments.

This experimental protocol was successfully used for the characterization of several compounds ranging

from small chemical molecules to larger snake toxins (Nguyen *et al.*, 2008; Roy *et al.*, 2010). As many samples may have no activity at the receptor tested the same oocyte can be used for several measurements. Moreover, samples causing inhibition may show a fast recovery, also allowing one to keep the same cell until its response falls below the desired criteria. As an example, effects of a series of samples were assayed on a single oocyte (Figure 5).

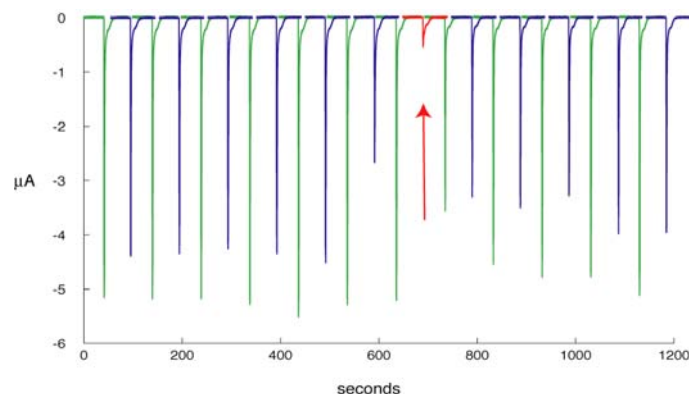

**Figure 5.** A single oocyte can be used for several measurements. Effects of a series of samples of unknown activity were tested on an oocyte expressing the human  $\alpha 7$  nAChR. Green traces were recorded in control conditions, whereas blue traces were recorded following 30 s exposure to a test sample. Note that one of these samples (red trace) caused a significant inhibition of the successive ACh-evoked current but that the response was almost completely recovered after a 90 s wash.

**Figure 5.** *Un unique oocyte peut être utilisé pour plusieurs mesures. Les effets d'une série d'échantillons inconnus ont été observés sur un oocyte exprimant le récepteur nicotinique  $\alpha 7$  humain. Les traces vertes représentent les conditions contrôles, tandis que les traces bleues montrent l'effet d'un échantillon après 30 s d'exposition. Il est à noter qu'un des échantillons (trace rouge) provoque une inhibition significative du courant en réponse à l'ACh contrôle. Une réponse normale est retrouvée après 90 s de lavage.*

A first and efficient analysis consists in plotting the ratio of current recorded immediately after the sample exposure *versus* the current recorded in control conditions. Testing performed with reference compounds, such as the competitive antagonist, methyllycaconitine (MLA), or the selective  $\alpha 7$  agonist, PNU-282987, indicates that compounds displaying an efficacy in the  $\mu\text{M}$  down to the nM range are easily detected (Figures 3 and 4).

Taking advantage of the powerful techniques established jointly by the Atheris and HiQScreen laboratories, we began the characterization of a spider venom derived from the "Melusine" library ([www.melusine.com](http://www.melusine.com)). These libraries are distinctive choices of high quality venoms meticulously prepared and pre-fractionated by reverse-phase HPLC (RP-HPLC) on an automated platform using well-established standard operating procedures. The fractions are dispensed in microplates and made ready for high throughput screening (HTS) in targeted lead discovery projects. This concept has been extended to a large venom library of more than 1,000 samples that represents the world's largest collection of animal venoms. With a selection of 400 venoms (snakes, scorpions, spiders, ants, bees, wasps, frogs, toads, salamanders, cone snails, sea anemones, jellyfishes, soft corals, gorgonians, and stonefishes), a comprehensive list of toxin-based libraries ready for high throughput screening and follow-up programmes has been first devised. One "Melusine" microplate was created with *Atrax robustus* venom that was tested on two  $\alpha$ -bungarotoxin sensitive nAChRs: the homomeric neuronal  $\alpha 7$  and muscle-type ( $\alpha 1\beta\gamma\epsilon$ ) receptor subtypes. Interestingly, while these two receptors are markedly inhibited by  $\alpha$ -bungarotoxin they show significant structural differences (Ballivet *et al.*, 1988; Servent *et al.*, 1997). Results obtained in a series of cells expressing the  $\alpha 7$  or  $\alpha 1\beta\gamma\epsilon$  nAChRs are illustrated in Figure 6.

These data illustrate that while RP-HPLC fractions 20 and 21 cause a marked inhibition of the  $\alpha 7$  nAChR, the same fractions fail to inhibit the muscle-type nAChR. Moreover, the non-destructive testing allows further characterization at other ligand-gated channels. About 200 recordings are captured in a single run of experiment that needs to be analyzed to detect the active fraction. It is therefore essential to have access to an adequate software for data analysis that otherwise becomes a substantial bottleneck. The HiClamp system offers the possibility to analyze and plot large amounts of data in a fast and user-friendly way. An alternative representation is a "heatplot" that consists in a colored representation of the response amplitude for each cell of the microtiter plate. Using a threshold cutoff this allows one to rapidly identify similitude and differences between effects of samples at multiple receptor subtypes.

Determination of active fractions from crude venom represents the first step toward the identification of a novel active substance. Typically, this is followed by deconvolution: a next round of purification and confirmation of the active fraction are then performed. Interestingly, as only a minute amount of substance was used in the first step (230  $\mu\text{L}$ ) a sub-fractionation of the sample can be performed directly from the initial sample. As subfractioning causes an increase in the purity of the active molecule it was possible to determine the effects of active compound even after two or three runs of purification. By appropriate combination of mass spectrometry and bioinformatics analysis, it is then possible to identify the nature of the active substance.

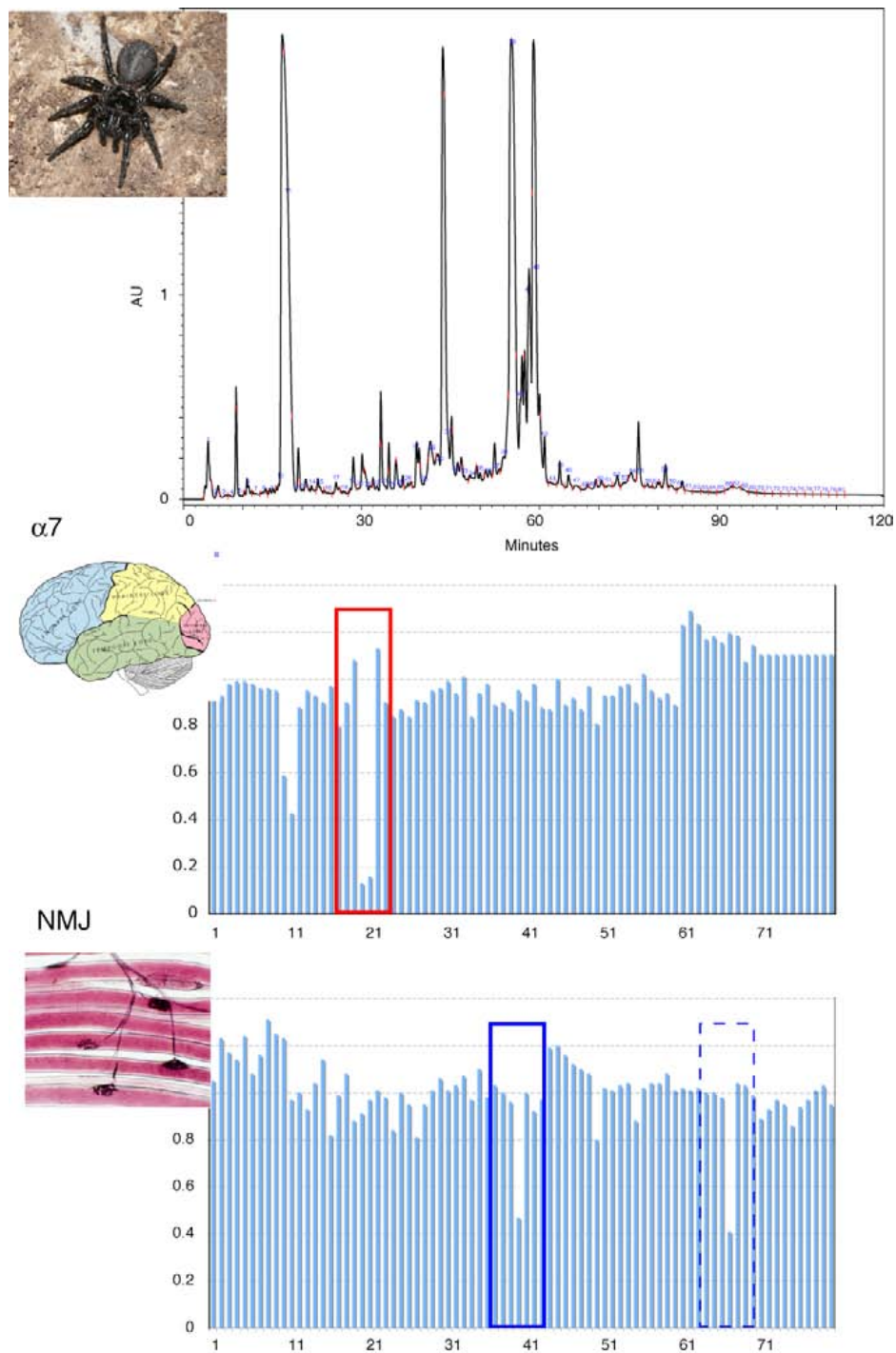

**Figure 6.** RP-HPLC chromatogram of *Atrax robustus* venom fractions and activity at neuronal  $\alpha 7$  and muscle-type  $\alpha 1_2\beta\gamma\epsilon$  (labelled NMJ) receptors. **Upper panel**, fractions obtained from the UV-HPLC chromatogram of the venom. Fractions were collected in a 96-well microtiter plate and dried under vacuum for storage. Fractions were resuspended in 1 mL physiological medium and aliquots of 23  $\mu\text{L}$  were diluted with 217  $\mu\text{L}$  physiological medium for electrophysiological measurements. **Middle panel**, histogram of the ACh-evoked currents recorded for each fraction sample tested on the  $\alpha 7$  nAChR. Note the marked reduction of the current amplitude (positions 20 and 21, red box). **Lower panel**, histogram of the ACh-evoked currents recorded in oocytes expressing the muscle-type receptors (blue boxes indicate samples displaying an inhibitory activity).

**Figure 6.** Chromatogramme par RP-HPLC du venin d'*Atrax robustus* et activité sur les récepteurs neuronal  $\alpha 7$  et musculaire  $\alpha 1_2\beta\gamma\epsilon$  (marqué NMJ). **Haut**, fractions obtenues par chromatographie HPLC du venin. Les fractions sont collectées dans une plaque à 96-puits et séchées sous vide pour stockage. Les fractions sont mises en solution dans 1 mL d'une solution physiologique et un aliquot de 23  $\mu\text{L}$  est dilué dans 217  $\mu\text{L}$  de solution finale pour les mesures. **Milieu**, histogramme des courants enregistrés en réponse à l'ACh pour chaque fraction testée sur le récepteur  $\alpha 7$ . Une baisse importante de l'amplitude du courant peut être notée pour les positions 20 et 21. **Bas**, histogramme des courants enregistrés en réponse à l'ACh pour chaque fraction testée sur le récepteur musculaire (encadré en bleu, fractions présentant une activité inhibitrice).

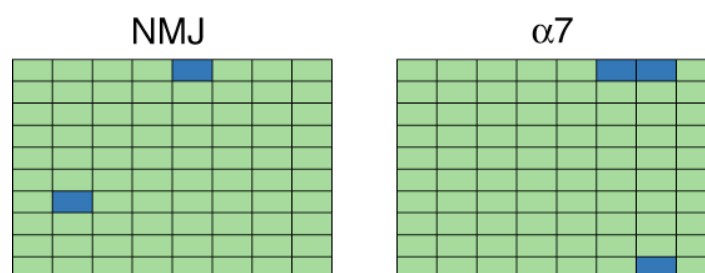

**Figure 7.** "Heatplot" showing the differential sensitivity of muscle-type (NMJ) and  $\alpha 7$  receptors to the *Atrax robustus* samples. ACh responses recorded after sample exposures are represented as green boxes if the amplitude is greater to 0.5-fold the amplitude of the control response. Blue boxes indicate responses smaller to 0.5 indicating a significant blockade of the receptor.

**Figure 7.** Représentation "Heatplot" montrant les activités des fractions du venin d'*Atrax robustus* sur les récepteurs musculaire (NMJ) et  $\alpha 7$ . La réponse à l'ACh enregistrée est représentée en vert si son amplitude est supérieure à 0,5 fois l'amplitude d'une réponse contrôlée. Les traces bleues indiquent des réponses inférieures à 0,5, montrant une inhibition significative des récepteurs.

## Discussion and Conclusions

RP-HPLC, as a breakthrough in separation techniques, has been particularly useful for the isolation of new chemicals. Moreover, improvements in the field of detection techniques such as mass spectrometry (MS) and nuclear magnetic resonance spectroscopy (NMR) (high field magnets, 2D-NMR experiments) have also greatly simplified the structure elucidation of organic molecules (Sarker *et al.*, 2006). The traditional approach in natural product isolation implies a bioassay-guided fractionation. This method is time-consuming and requires the availability of large amounts of biological material, which may be difficult to collect (rare, out-of-reach...). Considering the losses during each purification step (adsorption, compound instability...) and the initial concentration of the active compound in the sample (general estimation for a minor compound is around 0,1-1% of the total sample amount), several hundreds of grams of initial material are needed to obtain few mg of pure compound, which can then be used for activity confirmation and structure determination. Even with a micro NMR probe, few hundreds of micrograms are still needed to run 2D-NMR (HMBC) experiments. Finally, the rate of success is very low, since it often results in the isolation of already known compounds. Therefore, approaches combining the classical method with hyphenated techniques (HPLC-UV / diode-array detection (DAD)-MS / MS or HPLC-UV / DAD-NMR) are very powerful tools in dereplication of samples. In addition, only few micrograms of sample are needed to gather structural information on the compounds present in a complex matrix. These data (HPLC-UV, MS/MS and NMR spectra) can also be matched/compared against reference substances present in databases, and can speed-up the structure determination process. This is best illustrated with the so-called nanoVenomics approach (Favreau *et al.*, 2006) in which different MS and bioinformatic strategies are used to by-pass the isolation step and identify bioactive compounds without the need for repeated sample consuming bioassays. For instance, *de novo* peptide sequencing by MS/MS allows a rapid identification of known toxins as well as a partial or total primary peptide structure characterization for unknown molecules.

Among the chemical substances derived from natural extracts, venoms represent a rich source of active compounds. In fact, they are complex matrices of small proteins and peptides, which present the advantages of being often structurally stable to chemical and enzymatic degradation, very potent and highly specific towards their targets. These properties make them highly interesting as a source of promising drug candidates. Only a few hundreds of toxins have been isolated and characterized so far. According to their mechanism of action, they can be roughly divided into two main groups: a first group that consists of the non-enzymatic peptides and mini-proteins, which bind "passively" to their target receptor (such as the nicotinic/muscarinic ACh receptors), to voltage-sensitive ion channels ( $\text{Na}^+$ ,  $\text{K}^+$ ), or to transporters or enzymes that they modulate; and a second group that consists of toxins with enzymatic activity (such as proteases or phospholipases). For example,  $\beta$ -bungarotoxin, which was isolated from the venom of the snake *Bungarus multicinctus*, has a potent phospholipase activity and acts on the pre-synaptic motor nerve terminal of the neuromuscular junction by facilitating the spontaneous release of ACh (Liou *et al.*, 2006).

Toxins have a wide range of applications and are extremely important research tools. Being highly selective against a wide variety of pharmacological targets, they can be used as biological probes for the isolation, characterization and localization/distribution of their targets. A better understanding of the receptor structure and the receptor-ligand interactions may facilitate and speed up the design of new selective drugs (Tsetlin *et al.*, 2009). Taking into account that the pharmaceutical drug pipeline is undergoing pauperization and that each year, the number of new drugs approved by the FDA is declining, innovative approaches relying on methods such as HTS combined to genomic, transcriptomic and proteomic efforts offer an alternative drug discovery process (Ménez *et al.*, 2006; Li and Vederas, 2009; Favreau and Stöcklin, 2009). However, in spite of these needs, the number of methods allowing efficient discovery of new active molecules remains limited. There is an urgent need for new tools allowing one to study membrane proteins such as ligand-gated channels. Development of automatates such as POET highlighted the possible use of "slow" albeit sensitive

electrophysiological methods that can be exploited for studies of large libraries of pure compounds or semi-pure fractions (Trumbull *et al.*, 2003). The various instruments that were developed so far are all working according to the same principle, which consists in applying the physiological solution on the biological preparation which, for example, can be a *Xenopus* oocyte expressing the protein of interest.

The novel technique presented herein is based on a different approach with the moving of the sample under scrutiny, which allows several measurements to be performed on the same sample. Moreover, the sample size (230  $\mu$ L) is well adapted for studying compounds available in limited amount. Finally, the integration of this system in a fully automated setup extends the possibilities to study large number of samples and is well adapted to the characterization of venom fractions. Automation was designed to run fully unattended and is often employed day and night. Data obtained for *Atrax robustus* venom illustrate the feasibility of separation and rapid identification of active fractions. The finding of a fraction active on the human neuronal  $\alpha 7$  nAChR, but inactive on the muscle-type  $\alpha 1\beta\gamma\epsilon$  receptor, indicates that these venoms have evolved to efficiently block the cholinergic transmission. Given the some degree of conservation between the vertebrates and invertebrates it is plausible that the fraction active at the  $\alpha 7$  nAChR might also have activity at insect cholinergic neurotransmission.

Technical developments achieved in the field of chemistry, automation and computing open new possibilities to examine the functional activity of substances of biological interest. Combining these new technologies with the expression of invertebrate or mammalian genes in *Xenopus* oocytes opens new doors to the study of venoms, thus offering promising opportunities to discover new peptides or small molecules of therapeutic interests.

**Acknowledgements.** This work was supported by the EEC grant Neurocypres to HiQScreen.

## References

- Ballivet M, Nef P, Couturier S, Rungger D, Bader CR, Bertrand D, Cooper E (1988) Electrophysiology of a chick neuronal nicotinic acetylcholine receptor expressed in *Xenopus* oocytes after cDNA injection. *Neuron* **1**: 847-852
- Bertrand D, Cooper E, Valera S, Rungger D, Ballivet M (1991) Electrophysiology of neuronal nicotinic acetylcholine receptors expressed in *Xenopus* oocytes following nuclear injection of genes or cDNA. In *Methods in Neuroscience*, Conn M (ed) pp 174-193. New York: Academic Press
- Changeux JP, Galzi JL, Devillers-Thiéry A, Bertrand D (1992) The functional architecture of the acetylcholine nicotinic receptor explored by affinity labelling and site-directed mutagenesis. *Q Rev Biophys* **25**: 395-432
- Chimienti F, Hogg RC, Plantard L, Lehmann C, Brakch N, Fischer J, Huber M, Bertrand D, Hohl D (2003) Identification of SLURP-1 as an epidermal neuromodulator explains the clinical phenotype of Mal de Meleda. *Hum Mol Genet* **12**: 3017-3024
- Favreau P, Menin L, Michalet S, Perret F, Cheneval O, Stöcklin M, Bulet P, Stöcklin R (2006) Mass spectrometry strategies for venom mapping and peptide sequencing from crude venoms: case applications with single arthropod specimen. *Toxicon* **47**: 676-687
- Favreau P, Stöcklin R (2006) Marine snail venoms: use and trends in receptor and channel neuropharmacology. *Curr Opin Pharmacol* **9**: 594-601
- Fox JW, Serrano SM (2007) Approaching the golden age of natural product pharmaceuticals from venom libraries: an overview of toxins and toxin-derivatives currently involved in therapeutic or diagnostic applications. *Curr Pharm* **13**: 2927-2934
- Grishin AA, Wang CI, Muttenthaler M, Alewood PF, Lewis RJ, Adams DJ (2010) Alpha-conotoxin AuIB isomers exhibit distinct inhibitory mechanisms and differential sensitivity to stoichiometry of alpha3beta4 nicotinic acetylcholine receptors. *J Biol Chem* **285**: 22254-22263
- Lewis RJ, Garcia ML (2003) Therapeutic potential of venom peptides. *Nat Rev Drug Discov* **2**: 790-802
- Li JW, Vederas JC (2009) Drug discovery and natural products: end of an era or an endless frontier? *Science* **325**: 161-165
- Liou JC, Kang KH, Chang LS, Ho SY (2006) Mechanism of beta-bungarotoxin in facilitating spontaneous transmitter release at neuromuscular synapses. *Neuropharmacology* **51**: 671-680
- Ménez A, Stöcklin R, Mebs D (2006) 'Venomics' or: The venomous systems genome project *Toxicon* **47**: 255-259
- Miwa JM, Ibanez-Tallon I, Crabtree GW, Sánchez R, Sali A, Role LW, Heintz N (1999) lynx1, an endogenous toxin-like modulator of nicotinic acetylcholine receptors in the mammalian CNS. *Neuron* **23**: 105-114
- Nguyen KT, Syed S, Urwyler S, Bertrand S, Bertrand D, Raymond JL (2008) Discovery of NMDA glycine site inhibitors from the chemical universe database GDB. *Chem Med Chem* **3**: 1520-1524
- Roy A, Zhou X, Chong MZ, D'hoedt D, Foo CS, Rajagopalan N, Nirthanan S, Bertrand D, Sivaraman J, Kini RM (2010) Structural and functional characterization of a novel homodimeric three-finger neurotoxin from the venom of *Ophiophagus hannah* (King Cobra). *J Biol Chem* **285**: 8302-8315
- Sarker SD, Latif Z, Gray AI (2006) Natural products isolation. *Methods in Biotechnology* **20**, Humana Press.
- Servent D, Winckler-Dietrich V, Hu HY, Kessler P, Drevet P, Bertrand D, Ménez A (1997) Only snake curaremimetic toxins with a fifth disulfide bond have high affinity for the neuronal alpha7 nicotinic receptor. *J Biol Chem* **272**: 24279-24286
- Stöcklin R, Vorherr T (2010) Venoms - a natural source for mini-protein drugs. *Pharmaceutical: The international peptide review* Sept. 2010: 44-46
- Trumbull JD, Maslana ES, McKenna DG, Nemcek TA, Niforatos W, Pan JY, Parihar AS, Shieh CC, Wilkins JA, Briggs CA, Bertrand D (2003) High throughput electrophysiology using a fully automated, multiplexed recording system. *Receptors Channels* **9**: 19-28
- Tsetlin V, Utkin Y, Kasheverov I (2009) Polypeptide and peptide toxins, magnifying lenses for binding sites in nicotinic acetylcholine receptors. *Biochem Pharmacol* **78**: 720-731

## **Scorpion antivenoms : progresses and challenges**

Muhammad ZAHID<sup>1</sup>, Sonia ADI-BESSALEM<sup>2</sup>, Julien MUZARD<sup>1</sup>, Matthieu JUSTE<sup>3</sup>,  
Marie-France MARTIN-EAUCLAIRE<sup>4</sup>, Nicolas AUBREY<sup>3</sup>, Fatima LARABA-DJEBARI<sup>2</sup>,  
Philippe BILLIALD<sup>1\*</sup>

<sup>1</sup> Université Paris-Sud, Faculté de Pharmacie & Muséum national d'Histoire naturelle, F-75005 Paris, France ;

<sup>2</sup> Université des Sciences et de la Technologie Houari Boumediene & Institut Pasteur d'Alger, Algérie ;

<sup>3</sup> Université de Tours, Faculté de Pharmacie & INRA, F-37200 Tours, France ; <sup>4</sup> ToxCiM, Centre de Recherche en Neurobiologie-Neurophysiologie de Marseille (CRN2M), CNRS/Universités d'Aix-Marseille II-III, Faculté de Médecine - Secteur Nord, F-13344 Marseille, France

\* Corresponding author ; Tel : + 33 (0)1 4079 3155 ; Fax : +33 (0)1 4079 8857 ;

E-mail : [philippe.billiald@u-psud.fr](mailto:philippe.billiald@u-psud.fr)

---

### **Abstract**

*Serum therapy is the only specific treatment against scorpion envenoming, and antivenoms are still prepared by fragmentation of polyclonal antibodies isolated from hyperimmunized horse serum to form Fabs or F(ab)<sub>2</sub>. Most of these antivenoms are efficient, but their production remains tedious and time-consuming. Recombinant antibodies and smaller functional recombinant antibody units are now emerging as credible alternatives, and constitute a source of still unexploited biosubstances capable of neutralizing the effects of venoms. Recent advances suggest the possibility of important innovations in the development of specific recombinant antibody fragments that have better properties than conventional antivenoms in terms of homogeneity, specific activity and possibly safety.*

### **La sérothérapie anti-scorpionique : anticorps thérapeutiques d'aujourd'hui et de demain**

*La sérothérapie demeure le seul traitement spécifique des envenimations scorpioniques et aujourd'hui encore, les sérums antivenimeux sont préparés à partir d'immun-sérums de chevaux dont les anticorps polyclonaux ont été fragmentés en Fab ou F(ab)<sub>2</sub> par protéolyse ménagée. Même si ces sérums antivenimeux sont habituellement efficaces, leur préparation est longue et délicate. Aujourd'hui, les anticorps recombinants dirigés contre des toxines ainsi que leurs fragments actifs issus des biotechnologies constituent une source encore inexploitée de biomolécules capables de neutraliser les effets d'un venin. De récents travaux laissent entrevoir des innovations importantes pour le développement d'antidotes spécifiques aux propriétés améliorées avec une homogénéité, une activité spécifique et une sécurité d'emploi accrues par rapport à celles des sérums antivenimeux conventionnels.*

**Keywords :** *Androctonus, antivenom, scorpion, single-chain antibody, toxin.*

---

## **Introduction**

Scorpion envenoming is an important public health issue in many tropical and subtropical countries (Theakston *et al.*, 2003). Species capable of inflicting fatal stings are mainly found in North Africa and the Middle East (genera *Androctonus*, *Buthus* and *Leiurus*), in Central and Southern America (*Centruroides* and *Tityus*), in India (*Mesobuthus*) and in South Africa (*Parabuthus*). Scorpion venoms contain relatively low quantities of toxins compared to snake venoms, but their neurotoxins are very potent (Goyffon and Billiald, 2007). These toxins target the sodium, potassium, calcium and chloride channels. They induce direct effects and trigger the release of neurotransmitters (Gazarian *et al.*, 2005). The toxic effects of scorpion venoms are essentially due to the so-called long toxins consisting of 60-70 residues, which have a high affinity for the sodium channels of excitable cells. Following the binding of these toxins, a massive release of acetylcholine and catecholamines is induced, which in turn leads to signs of overactivity of the autonomic system or an "autonomic storm". Intense local pain is the first effect, even when the venom has no life-threatening potential. Systemic clinical signs (fever, sweating, hypertension, vomiting, and priapism) are observed 2-4 h after the sting. The symptoms evolve rapidly, and several stages of increasing severity can be distinguished (Goyffon and Billiald, 2007). Stage 3 corresponds to very severe envenoming, and is potentially lethal. Here, the greatest risk is that of cardiovascular collapse associated with major respiratory complications. Patients at this stage are usually kept under close surveillance in an intensive care unit. Apart from symptomatic treatment, which involves the use of local anesthetics and anti-histamine drugs, serum therapy is the only specific treatment. It is widely used in serious cases of envenoming,



and has contributed to a significant decrease in mortality (Boyer *et al.*, 2009). This is particularly well exemplified in Mexico, where the mortality has significantly fallen from 700-800 to less than 100 within twelve years. However, the interest of using antivenoms remains controversial in several countries (Abroug *et al.*, 1999). Such discrepancies could be related to the lack of standardization in the use of antivenoms and in their preparation. Scorpion neurotoxins diffuse into tissues very quickly, and bind to their target almost irreversibly. Some clinicians are of the opinion that the time between the scorpion sting and the administration of the antivenom is often too long to allow the antibodies to trap the unbound toxins. Conventional therapeutic antibody fragments (100 kDa in the case of  $F(ab)_2$ ) are much larger than toxins (7 kDa), a feature which limits their ability to diffuse from the vascular compartment into the tissues. In addition, antivenoms are products of biological origin. These are still derived from equine polyclonal antibodies raised against the entire venom. They have a low specific activity, which may be the potential cause of ineffectiveness. This low specific activity also means that patients are injected with large quantities of heterologous immunoglobulins, thus increasing the risk of major immune adverse reactions such as serum sickness. In a few cases, hypersensitivity reactions, which can reach the severity of anaphylactic shock, have also been reported.

What is required is a standardized source of high-titer antibodies targeting the most potent toxins that are responsible for the lethality, and which represent just a few components of the venom. Monoclonal antibodies derived from the hybridoma technology could meet these criteria, but they have never been approved for therapeutic use due to their murine origin (Nissim and Chernajovsky, 2008). Today, molecular engineering has made it possible to create recombinant antibody fragments specific for any antigen, sometimes without requiring the immunization of animals and the fragmentation process. The various features of natural antibodies can be tailored by a variety of methods to fit the requirements of a particular treatment. These include size, tissue penetration and distribution, half-life, stability, affinity and immunogenicity (Laffly and Sodoyer, 2005). Several research projects are currently investigating the therapeutic potential of recombinant antibody fragments as substitutes for conventional polyclonal  $F(ab)_2$  derived from immune sera.

### Fragments of recombinant antibodies : an unexploited diversity

Many hybridomas that secrete well-characterized monoclonal antibodies are available. Access to their genes has made it possible firstly to clone the VH and VL domains responsible for the specificity of antigen recognition, and then subsequent generation in the form of recombinant proteins (*Figure 1*).

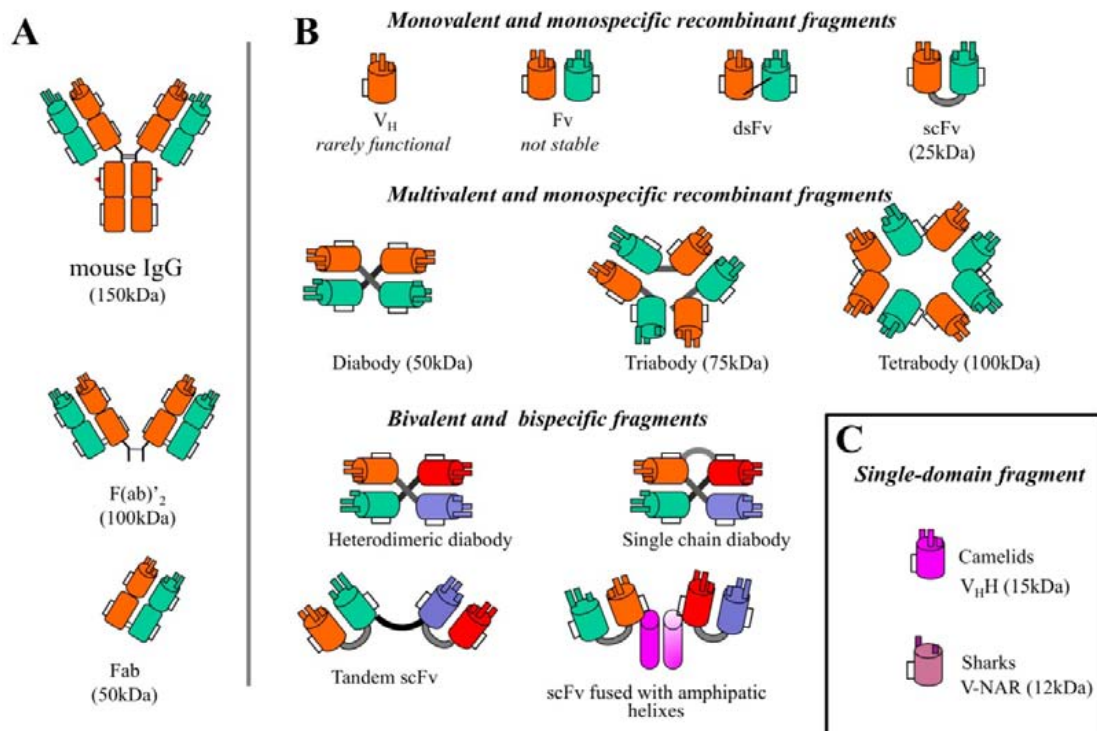

**Figure 1.** Dissection of immunoglobulins into minimal binding fragments and reformatting into multivalent recombinant reagents. (A) Monoclonal IgG and its functional fragments prepared by limited proteolysis. (B) A selection of recombinant antibody fragments derived from the antibody variable domains. (C) The minimal functional units, simply made of one antibody domain, that are extracted from exotic animal species.

**Figure 1.** Immunoglobulines et fragments d'anticorps recombinants. (A) IgG monoclonale et ses fragments actifs issus de la protéolyse ménagée. (B) Sélection de fragments d'anticorps recombinants constitués des domaines variables d'anticorps. (C) Unités fonctionnelles minimales, constituées d'un seul domaine d'anticorps, qui sont isolées d'espèces animales "exotiques".

Very few examples of isolated VHs or of Fvs (VH and VL associated in a non-covalent manner) were initially described, then new arrangements were invented, which made it possible to modify their size and valence, and to create a wide range of diverse active antibody fragments (Holliger and Hudson, 2005). These new formats can be used, for instance, to improve the tissue diffusibility and the bioavailability of the antibody, and also to make them less immunogenic, more "human" or even fully human.

In a fragment of recombinant monovalent antibody, consisting solely of variable domains, the ability to recognize antigens is maintained properly only if the association of VH and VL is stabilized by a disulfide bridge (dsFv) inserted by molecular engineering, or a peptide bond (scFv), which provides the junction between the C- and N-terminals of the two domains. 25-kDa single-chain variable fragments (scFv) are the molecules most often described. Various linkers have been used, depending on whether the association takes place in VH/VL direction or VL/VH direction, and the size of these bonds is also important. Several linkers of about fifteen residues have been reported to induce the formation of monovalent, monomeric molecules. Shorter linkers (5 residues) create a constraint between the variable domains of the same molecule, which favors the formation of a dimer also called diabody, which has the same size as a Fab fragment (50 kDa) but is bivalent. An even shorter linker (1 residue or even no residue) results in trimeric (triabody) or even tetrameric (tetraabody) multivalent assemblies.

Various molecular engineering strategies have been developed to create the basic module: scFv. A widely used one consists of cloning antibody domains from a murine hybridoma, which can subsequently be chimerized or humanized (Figure 2). Humanization consists of grafting the hypervariable regions (CDRs) responsible for the antigen recognition specificity onto the scaffold of human immunoglobulins. This is a challenge which has been made much easier by crystallographic analyses that provide details of the interface between the antigen complexes/antibodies at the atomic scale. Access to data banks and softwares that list, analyze, and compare all available antibody sequences also provides useful information (Lefranc *et al.*, 2009).

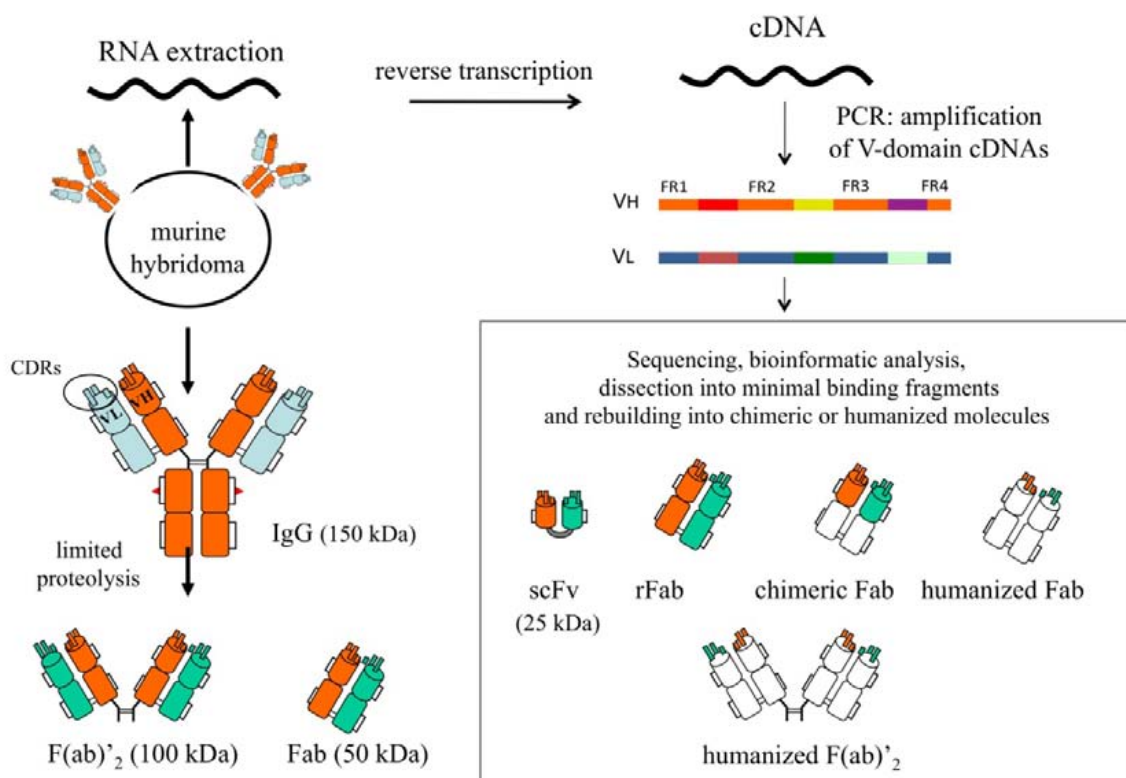

**Figure 2.** Hybridoma as a source of recombinant antibodies. After extraction of the hybridoma mRNA and reverse transcription, the cDNAs encoding the antibody variable domains are PCR amplified, sequenced and cloned. Recombinant antibody fragments with low immunogenicity can be designed. In chimeric antibody fragments all the murine constant domains are substituted by constant domains of human origin. In humanized antibody fragments the murine antibody CDRs are grafted onto human V-domain frameworks

**Figure 2.** Les hybridomes, sources d'anticorps recombinants. Après extraction de l'ARNm et transcription inverse, l'ADNc codant les domaines variables d'anticorps est amplifié par PCR, séquencé et cloné. Des fragments d'anticorps recombinants de faible immunogénicité peuvent être conçus. Dans les fragments d'anticorps chimériques, tous les domaines constants d'origine murine sont remplacés par des domaines constants d'origine humaine. Dans les fragments humanisés, les boucles hypervariables (CDR) murines sont greffées sur des molécules d'immunoglobulines humaines.

Another very attractive strategy is to construct antibody V-domains gene repertoires expressed *in vivo* on the surface of bacteriophages (phage display) or yeast (yeast display) or *in vitro* (ribosome display). Then,

these libraries are screened against the antigen of interest (Bradbury and Marks, 2004). Such repertoires can be constructed from an inventory of human antibodies, which is an advantage if therapeutic applications are expected. However, the scFvs isolated from these repertoires are often of mediocre quality in terms of their affinity for the target antigen, and affinity maturation processes have to be carried out. An alternative consists of using an immune repertoire. For obvious ethical reasons, such libraries must only be constructed against antigens to which Man is naturally exposed. For the other antigens, such as toxins, an alternative approach has been suggested. It consists of creating an immune repertoire of scFv or Fab of antibodies of primates (macaques), which are closely related to human beings. Fragments of antibodies that target plant (ricin) or bacterial (anthrax) toxins have been isolated from such libraries (Pelat *et al.*, 2009).

## Towards a new generation of anti-venoms

Conventional antivenoms still consist of a mixture of polyclonal antibody fragments, only a small fraction of which targets the dangerous toxins, and a still smaller proportion consists of neutralizing antibodies. The recombinant antibody technology offers a way of isolating an antibody of interest from such a heterogeneous population. Then, this antibody can be "rebuilt" in the form of a single small molecule well suited for particular applications. Thus, several groups have tried to assess the potential of recombinant antibody fragments to neutralize the action of toxins, or even provide protection against envenoming. At present these studies essentially concern scorpion venoms, which are less complex than snake venoms, and the toxic effects in human beings are due to the effects of a limited number of neurotoxins that act on the membrane sodium channels activated by the voltage of the so-called "excitable" cells.

In central and north America, the scorpions of the genus *Centruroides* are amongst the most dangerous for Man. The toxicity of their venom is essentially due to structurally similar neurotoxins, the action of which can be neutralized experimentally by the monoclonal murine antibody BCF2. A scFv fragment derived from this antibody, and variants that have undergone *in vitro* "maturation", have been created and assessed for their ability to neutralize the action of the venom (Juarez-Gonzalez *et al.*, 2005). The authors have already shown that the action of the venom incubated with these scFvs before being injected into mice was neutralized. Other scFvs have also been selected by the same group by screening a repertoire of human phages-antibodies, with the potential advantage of improved acceptability (Riano-Umbarila *et al.* 2005). However, the protective potential of these substances has never been assessed under experimental conditions that mimic those of natural envenoming in which the antidote is injected after the venom, and via a different route.

Other studies also show that scFvs diffuse rapidly into tissues, thus facilitating the uptake and neutralization of any free toxins not yet bound to a receptor. However, their plasma half-life is extremely short (a few minutes) and insufficient to provide effective protection *in vivo*. Cross-linking scFvs with polyethyleneglycol (PEG) could improve their stability and solubility, prolonge their circulation time, slower their clearance and reduce their immunogenicity. An alternative strategy consists in creating multimeric scFv molecules, which still have low immunogenicity, because they lack the constant domains of murine antibodies, but which have modified pharmacokinetic characteristics and a longer half-life. Thus, diabodies, which are of the same size as Fab but with two antigen recognition sites, have greater efficacy (Aubrey *et al.*, 2003). It has been shown that a diabody that targets the *Aahl* neurotoxin of the venom of the north-African scorpion *Androctonus australis* could be adapted to protect experimentally envenomed mice, with greater efficacy than the conventional antivenoms.

For the dangerous scorpions of the Old World, such as *Androctonus australis*, the toxins that are active at the sodium channels are characterized by having greater structural and antigenic polymorphism. Thus, it has been estimated that 90% of the lethal activity of the venom is attributed to 3 toxins (*Aahl*, *AahlI* and *AahlII*) belonging to two distinct immunological groups, so that the action of the venom can be neutralized only by using at least two antibodies with different specificities. Molecular engineering has made it possible to develop a single recombinant antibody fragment, which is the same size as a Fab, but bivalent and bispecific, that can simultaneously recognize the toxins of both groups (Juste *et al.*, 2007). Various molecular constructions can be envisaged (Figure 1). The tandem scFv format has been constructed using the variable domains of the 9C2 and 4C1 antibodies, which target the toxins of groups I (*Aahl* and *AahlII*) and II (*AahlI*), respectively (Figure 3). The recombinant scFv protein produced in bacteria is fully functional, bivalent and bispecific. It has high affinity for both groups of toxins, and its protective capacity has been shown to be 150 DL<sub>50</sub>/mg in the experimentally envenomed mouse, a value which is 300-fold greater than that usually found for polyclonal antivenoms.

Other avenues have also been explored. Unique antibodies lacking the light chain have been reported in sharks (Ig-NAR) or in Camelids (HCAb). A V-NAR single domain (12 kDa) directed to a scorpion toxin has been isolated from a phage display library immunized with scorpion toxin Cn2 (GenBank AAX10141.1). However its functional properties remain to be explored. In HCAbs, the antigen-binding site is a single protein domain (V<sub>H</sub>H) of 15 kDa (Harmsen and Haard, 2007). The V<sub>H</sub>H is extremely stable and easily produced in bacteria or yeast. V<sub>H</sub>Hs that neutralize *Androctonus australis* toxins have recently been identified by screening an immune library. Two of these antibody fragments have been reformatted into a bispecific molecule that fully neutralizes the whole venom (Hmila *et al.*, 2010). Although these innovative molecules (scFv, V-NAR and V<sub>H</sub>H) are very attractive, their therapeutic potential has now to be compared in a reproducible and rigorous manner by using well-standardized assays in which the LD<sub>50</sub> of the venom is experimentally determined. Such assays will have to take into account the time interval between the sting and the treatment, the administration routes of the venom and the antidote. Assays such as the intra-cerebroventricular injection of venoms pre-incubated with antidotes have no longer to be used to predict the therapeutic potential of antibodies fragment even if they provide interesting information.

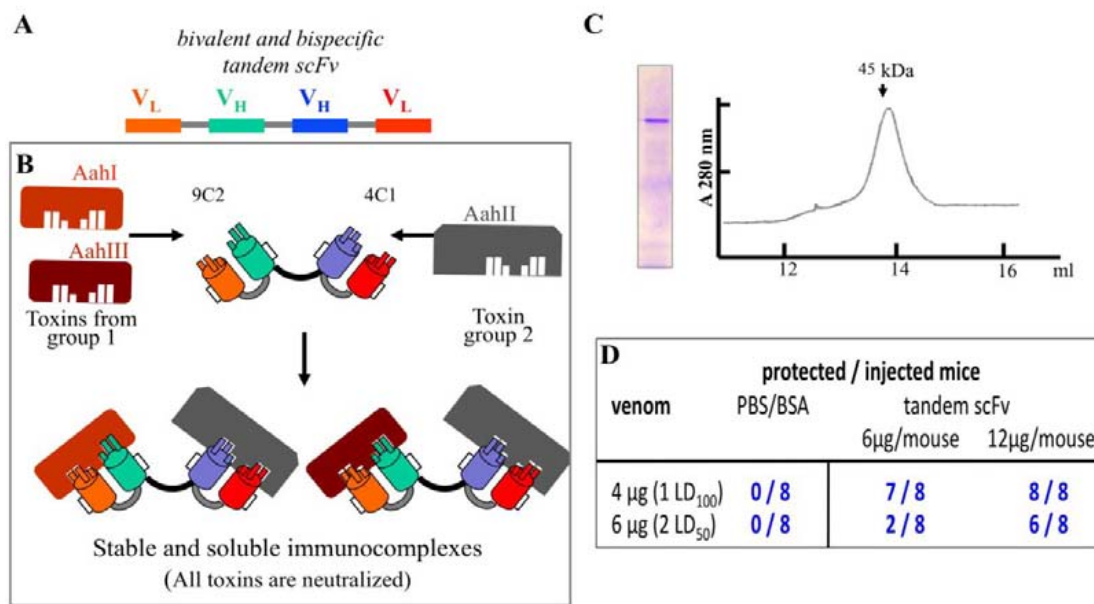

**Figure 3.** A bispecific tandem scFv that protects against experimental envenomation. (A) Schematic representation of the cDNA encoding the tandem scFv. (B) Schematic representation of the neutralization of *Androctonus australis* toxins AahI, AahII, AahIII using the tandem scFv. (C) Electrophoretic and gel filtration analysis of the purified tandem scFv. (D) The intraperitoneal injection of tandem scFv to mice experimentally envenomed by a subcutaneous administration of the venom.

**Figure 3.** Un fragment d'anticorps scFv en tandem protège contre une envenimation expérimentale. (A) Représentation schématique de l'ADNc codant un scFv en tandem. (B) Représentation schématique de la neutralisation des toxines AahI, AahII, AahIII d'*Androctonus australis* par le scFv en tandem. (C) Analyse des préparations de scFv en tandem par électrophorèse SDS et chromatographie d'exclusion stérique. (D) Analyse des effets de l'injection intrapéritonéale du scFv en tandem à des souris expérimentalement envenimées par voie sous-cutanée.

### Polyvalent recombinant antivenoms?

Several venomous species often cohabit, which makes it necessary to produce polyvalent antivenoms with several targets. In Tunisia, for example, the scorpion *Buthus occitanus* shares the same territory as *Androctonus australis*, but the tandem scFv that targets *A. australis* is unable to interact with the most potent toxin of *B. occitanus* (BotIII), even though it differs from the AahII toxin by three amino acid residues only. A crystallographic analysis of the AahII/Fab 4C1 toxin complex has shown that the nature of the C-terminal residue (H64>N), which is located in the interaction zone, is probably responsible for this (Fabrichny *et al.*, 2007). The construction of a library of 4C1-derivative phage-antibodies, mutated in a random fashion at the CDR residues in contact with His64, and its dual screening versus the BotIII and AahII toxins, could lead to the selection of mutants with crossed reactivity for both toxins. Powerful methods of affinity maturation and selectivity have already been developed to optimize the specificity of antibodies, in particular of anti-steroid antibodies (Dubreuil *et al.*, 2005). Replacing the variable domains derived from 4C1 in the tandem scFvs by the variable domains of the selected mutants would then lead to a polyvalent antivenom, consisting of a single molecule able to neutralize the major toxins of the venoms of *Androctonus australis* and of *Buthus occitanus*.

### What are the prospects for the future?

With the rise of molecular engineering, the diversity of active antibody fragments has increased considerably, and they are no longer limited to Fab or F(ab)<sub>2</sub> fragments, which were the only formats accessible for many years, due to the limits imposed by limited proteolysis. Many formats of recombinant antibody fragments have already been designed, and there is no doubt that many others remain to be invented.

It is clear that the therapeutic management of serious envenoming could one day benefit from this progress. Results obtained recently by various groups in Europe, in Africa and in central and south America clearly demonstrate the therapeutic potential of recombinant antibody fragments, and the advantages that they could offer compared to preparations derived from animal immunosera, which are always broad mixtures and produced in a manner that is difficult to reproduce.

Advances in recombinant antibody technology have made it possible to renew the interest in therapeutic antibodies (Nelson *et al.*, 2010). Today, more than twenty-four molecules have been approved by the FDA with a wide range of applications and several hundred are in preclinical trials or under FDA review (Nelson *et al.*, 2010).

The manufacturers of antivenoms are interested in these studies which could pave the way to the development and implementation of innovative therapies.

**Acknowledgements.** We are indebted to Conor Fields (University College of Dublin, Ireland) for stimulating discussions and critical reading of the manuscript.

## References

- Abroug F, ElAtrous S, Noura S, Haguiga H, Touzi N, Bouchoucha S (1999) Serotherapy in scorpion envenomation: a randomised controlled trial. *Lancet* **354**: 906-909
- Aubrey N, Devaux C, Sizaret PY, Rochat H, Goyffon M, Billiald P (2003) Design and evaluation of a diabody to improve protection against a potent scorpion neurotoxin. *Cell Mol Life Sci* **60**: 617-628
- Boyer LV, Theodorou AA, Berg RA, Mallie J, Arizona Envenomation Investigators, Chávez-Méndez A, García-Ubbelohde W, Hardiman S, Alagón A (2009) Antivenom for critically ill children with neurotoxicity from scorpion stings. *N Engl J Med* **360**: 2090-2098
- Bradbury ARM, Marks JD (2004) Antibodies from phage antibody libraries. *J Immunol Methods* **290**: 29-49
- Dubreuil O, Bossus M, Graille M, Bilous M, Savatier A, Jolivet M, Menez A, Stura E, Ducancel (2005) Fine tuning of the specificity of an anti-progesterone antibody by first and second sphere residue engineering. *J Biol Chem* **280**: 24880-24887
- Fabrichny I, Conrod S, Martin-Eauclaire MF, Devaux C, Bourne Y, Marchot P (2007) Vers une amélioration de l'immunothérapie antiscorpionique: approche structurale. In *Toxines émergentes: nouveaux risques*. Collection Rencontres en Toxinologie, Goudey-Perrière F, Benoit E, Marchot P, Popoff MR (eds) pp 197-202. Paris: Lavoisier
- Gazarian KG, Gazarian T, Hernandez R, Possani LD (2005) Immunology of scorpion toxins and perspectives for generation of anti-venom vaccines. *Vaccine* **23**: 3357-3368
- Goyffon M, Billiald P (2007) Le scorpionisme en Afrique. *Médecine Tropicale* **67**: 439-446
- Harmsen MM, De Haard HJ (2007) Properties, production, and applications of camelid single-domain antibody fragments. *Appl Microbiol Biotechnol* **77**: 13-22
- Hmila I, Saerens D, Ben Abderrazek R, Vincke C, Abidi N, Benlasfar Z, Govaert J, El Ayeb M, Bouhaouala-Zahar B, Muyldermans S (2010) A bispecific nanobody to provide full protection against lethal scorpion envenoming. *FASEB J* **24**: 3479-3489
- Holliger P, Hudson PJ (2005) Engineered antibody fragments and the rise of single domains. *Nat Biotechnol* **23**: 1126-1136
- Juárez-González VR, Riaño-Umbarila L, Quintero-Hernández V, Olamendi-Portugal T, Ortiz-León M, Ortiz E, Possani LD, Becerril B (2005) Directed evolution, phage display and combination of evolved mutants: a strategy to recover the neutralization properties of the scFv version of BCF2 a neutralizing monoclonal antibody specific to scorpion toxin Cn2. *J Mol Biol* **346**: 1287-1297
- Juste M, Martin-Eauclaire MF, Devaux C, Billiald P, Aubrey N (2007) Using a recombinant bispecific antibody to block Na<sup>+</sup>-channel toxins protects against experimental scorpion envenoming. *Cell Mol Life Sci* **64**: 206-218
- Laffly E, Sodoyer R (2005) Monoclonal antibodies, 30 years after... *Hum Antibodies* **14**: 33-55
- Lefranc MP, Giudicelli V, Ginestoux C, Jabado-Michaloud J, Folch G, Bellahcene F, Wu Y, Gemrot E, Brochet X, Lane J, Regnier L, Ehrenmann F, Lefranc G, Duroux P (2009) IMGT, the international ImmunoGeneTics information system. *Nucleic Acids Res. Data base issue* D1006-12
- Nelson AL, Dhimolea E, Reichert JM (2010) Development trends for human monoclonal antibody therapeutics. *Nature Rev Drug Discov* **9**: 767-774
- Nissim A, Chernajovsky Y (2008) Historical development of monoclonal antibody therapeutics. *Handb Exp Pharmacol* **181**: 3-18
- Pelat T, Hust M, Hale M, Lefranc MP, Dübel S, Thullier P (2009) Isolation of a human-like antibody fragment (scFv) that neutralizes ricin biological activity. *BMC Biotechnol* **9**: 60
- Riaño-Umbarila L, Juárez-González VR, Olamendi-Portugal T, Ortiz-León M, Possani LD, Becerril B. (2005) A strategy for the generation of specific human antibodies by directed evolution and phage display. An example of a single-chain antibody fragment that neutralizes a major component of scorpion venom. *FEBS J* **272**: 2591-2601
- Theakston RD, Warrell DA, Griffiths E (2003) Report of a WHO workshop on the standardization and control of antivenoms. *Toxicon* **41**: 541-557
-

## **Ingénierie moléculaire des antitoxines : avantages des “Nanobodies” de Camélidés pour l’immunothérapie antivenimeuse**

Balkiss BOUHAOUALA-ZAHAR<sup>1,2\*</sup>, Issam HMILA<sup>1</sup>, Rahma BEN ABDERRAZEK<sup>1</sup>,  
Naima ABIDI<sup>1</sup>, Serge MUYLDERMANS<sup>3</sup>, Mohamed EL AYEB<sup>1</sup>

<sup>1</sup> Laboratoire des Venins et Toxines, Institut Pasteur de Tunis, 13 Place Pasteur, BP74, 1002 Tunis, Tunisie ;  
<sup>2</sup> Faculté de Médecine de Tunis, Université de Tunis El Manar, Tunis, Tunisie ; <sup>3</sup> Laboratory of Cellular and Molecular Immunology and Department of Cellular and Molecular Interactions, Vrije Universiteit Brussel (VIB), Brussels, Belgium

\* Auteur correspondant ; Tél : +21671843755 (ext 472) ; Fax : +21671791833 ;  
Courriel : [balkiss.bouhaouala@pasteur.rns.tn](mailto:balkiss.bouhaouala@pasteur.rns.tn)

---

### **Résumé**

Plusieurs formats d'anticorps dirigés contre les toxines de venins de scorpions et même de serpents ont été rapportés dans la littérature. Certains sont couramment utilisés comme traitement spécifique de l'envenimation, d'autres sont surtout utilisés pour des études immunobiochimiques des toxines. Leur nature et leur mode de préparation diffèrent quelque peu d'un laboratoire à un autre. Les immunoglobulines totales, les fragments de type Fab (pour Fragment antigen-binding) et Fab'2 polyclonaux sont préparés à partir de sérums. Un certain nombre d'anticorps monoclonaux ont été également obtenus et rapportés. Ces derniers ont servi à la construction de formes recombinantes de type Fv, ScFv et Fab. Par ingénierie moléculaire, des dérivés bivalents, bispécifiques ou plus ont été également conçus et caractérisés. Les propriétés pharmacocinétiques ont été dans certains cas étudiées et publiées. Selon qu'ils soient d'origine équine, murine ou encore issus de camélidés, ces anticorps ou fragments d'anticorps présentent des avantages et des inconvénients qui permettent de les distinguer. Certains laissent entrevoir plus d'espoir pour la sérothérapie de demain. A travers les exemples, nous nous efforcerons de montrer également combien la comparaison de leurs efficacité est difficile du fait du manque de normalisation et de standardisation des protocoles de préparation des immunogènes, des procédés de production et/ou de la nature des produits proposés.

### **Molecular engineering of antitoxins : benefits from camelid Nanobodies for antivenom immunotherapy**

Several antibody formats raised against scorpion and snake venoms or toxins have been reported. Some are commonly used for specific treatment of envenomation diseases, while others are especially used for immunobiochemical studies. Their composition and mode of preparation are substantially different from one research unit to another. Total immunoglobulins, Fab fragments (for Fragment antigen-binding) and Fab'2 were prepared from polyclonal sera. A few monoclonal antibodies were also obtained and used for producing recombinant Fv, ScFv and Fab antibody fragments. By molecular engineering, derivatives (i.e. bivalent or bispecific) were also designed and characterized. Their pharmacokinetics was studied in some cases. Despite their distinct origins (i.e. equine, murine or camelids) these antibody fragments have advantages and disadvantages that distinguish them. Some have future potential for more efficient antivenom immunotherapy. Through examples, we will show how the comparison of their effectiveness is tricky due to lack of protocol standardizations for immunogen preparations, production processes and final products.

**Keywords :** Antibody fragment, immunotherapy, Nanobody, neutralizing capacity, venom toxin.

---

### **Introduction**

Les anticorps dirigés contre les toxines animales sont systématiquement développés pour traiter de nombreux cas d'envenimations. Ces envenimations sont provoquées par des morsures de serpents, des piqûres de scorpions ou autres Arthropodes dont la prise en charge est une urgence médicale très fréquente. Les régions où vivent ces animaux sont des régions tropicales et subtropicales souvent confrontées à des difficultés économiques. La population locale, mais aussi les touristes et les aides humanitaires qui s'y trouvent, doivent être efficacement protégées. Malgré les nombreuses campagnes de sensibilisation et de prévention

régulièrement menées, plusieurs dizaines de milliers de cas d'envenimation sont enregistrés annuellement et on estime que la capacité mondiale de protection reste insuffisante (conf. Communiqué de l'OMS, 2007). Le scorpion est responsable à lui seul d'une grande majorité des accidents et il est admis qu'*Androctonus australis hector* (Aah) possède l'un des venins les plus toxiques (Bouaziz *et al.*, 2008; Granier *et al.*, 2009).

Les nombreuses molécules découvertes dans les venins et qui sont responsables de l'effet léthal chez les Mammifères et en particulier chez l'Homme sont considérées comme des toxines. Généralement, les toxines de venins de scorpions agissent sur la conductance des canaux ioniques des cellules excitables (Gordon *et al.*, 2007). Les toxines de venins de serpents interviennent sur la conduction neuromusculaire. Elles sont parfois de nature enzymatique et provoquent des syndromes inflammatoires, hémorragiques ou nécrotiques (Harvey, 1991; Servent et Fruchart-Gaillard, 2009). Leur toxicité est mesurée par leur effet léthal après injection, en particulier chez la souris. Les symptômes qu'elles induisent diffèrent et permettent de les classer en fonction de leurs cibles. D'autres classifications existent et regroupent les toxines selon leurs modes d'action et/ou leurs structures.

Pour lutter contre ces maladies environnementales et accidentelles mais fréquentes par envenimations, des sérums antivenins sont développés. Ils ont donné naissance à la sérothérapie antivenimeuse, il y a plus d'un siècle déjà. Les sérums antiscorpioniques et antivipérins en particulier (respectivement SAS et SAV à base de sérum équin) représentent souvent la seule alternative capable de sauver des vies. Néanmoins, ils ne sont pas utilisés dans le monde entier en thérapie d'urgence pour traiter les cas graves d'envenimation. Certains pays n'y sont pas favorables et optent pour un traitement exclusivement symptomatique (Soulaymani-Bencheikh *et al.*, 2002). A base d'anticorps d'origine animale (équine, ovine, etc. ...), l'efficacité de ces antivenins est variable du fait de leur nature polyclonale. Elle dépend également du procédé de leur préparation et de la santé de l'animal producteur. Il est admis que l'effet bénéfique de cette sérothérapie ne peut être observé que si son administration est effectuée dans un délai interventionnel très bref.

Ainsi, le sérum polyclonal, composé d'anticorps polyclonaux (i.e. immunoglobulines) est soumis à un procédé de production de fragments d'anticorps de plus petite taille par digestion pepsique ménagée, difficilement contrôlée et reproductible. A partir du sérum, les fragments fonctionnels Fab'2, correspondant à une immunoglobuline dépourvue du fragment Fc et présentant les deux paratopes de liaison à l'antigène (*Figure 1*), sont purifiés par un procédé de dialyse/filtration qui est suivi d'une étape de clarification stérilisante. La capacité de neutralisation de ces produits, contrôlée par des tests de séroneutralisation et de protection sur la souris, est variable d'une production à une autre. Pour une meilleure action thérapeutique, de fortes doses sont actuellement injectées par la voie intraveineuse (considérée plus efficace que la voie intramusculaire). En outre, de par leur taille (100 kDa), les fragments Fab'2 équins sont 14 fois supérieurs à la taille d'une toxine de scorpion par exemple (7 kDa) et de ce fait ne possèdent pas la même cinétique de diffusion dans l'organisme. Ces observations ont été confirmées par des études pharmacocinétiques qui ont permis de démontrer la distribution très rapide des toxines dans le sang et les divers tissus, en comparaison à celle des Fab'2 (Krifi *et al.*, 2001).

Parmi les améliorations multiples proposées pour le traitement des envenimations, les anticorps monoclonaux (ACM) et les anticorps recombinants (ACr), contre les toxines les plus actives des venins, sont les plus prometteurs pour prévenir la morbidité et la mortalité. Ces anticorps antitoxines ont été ces trente dernières années au cœur des investigations des équipes de recherche travaillant dans le domaine. Pour une meilleure spécificité, les molécules les plus toxiques ont été identifiées, caractérisées immuno-biochimiquement et utilisées pour produire ces anticorps. L'ingénierie moléculaire de ces fragments d'anticorps s'est considérablement développée parallèlement au développement de la technologie de l'ADN recombinant et différentes tailles et formes d'antitoxines ont été obtenues. Toutes sont systématiquement testées pour leur efficacité à neutraliser les toxines et à protéger l'animal (i.e. la souris) contre l'effet toxique de doses létales injectées.

## Généralités sur les antivenins et les antitoxines

Les venins d'organismes animaux sont riches en molécules actives diverses et recherchées. Certaines n'induisent aucun effet toxique et ne sont donc pas impliquées directement dans la symptomatologie de l'envenimation. D'autres induisent des effets toxiques de différentes natures et puissances. Il est admis qu'une molécule est une toxine lorsqu'elle induit un effet léthal sur un modèle animal (tel que la souris, ou un Arthropode; Zlotkin *et al.*, 1972).

La technologie de préparation des antivenins est particulièrement bien maîtrisée depuis plusieurs dizaines d'années. Il existe deux approches stratégiques pour la préparation d'antivenins: la première consiste à développer un antivenin spécifique pour chaque venin ou à la limite pour deux venins différents (i.e. l'antivenin scorpionique SAS de l'Institut Pasteur de Tunis, qui neutralise l'effet toxique de deux venins de scorpions *Androctonus australis hector* et *Buthus occitanus tunetanus*). La seconde consiste à développer un antivenin polyclonal dirigé contre les venins de plusieurs scorpions ou serpents cohabitant sur le même biotope ou région (i.e. l'antivenin scorpionique de l'Institut Pasteur de Téhéran). Lorsque cette spécificité est plus particulièrement dirigée contre quelques toxines du venin, il plus communément usuel de parler d'antitoxines.

### Les antivenins

Les antivenins sont des préparations à base d'anticorps dirigés contre la totalité ou la fraction toxique du venin (utilisés comme immunogène vaccinal) qui ont une spécificité polyclonale large. L'activité spécifique de ce type de produit antivenimeux varie en fonction de la nature de l'immunogène et également du mode de préparation de ces derniers à partir du sang périphérique. L'animal le plus souvent utilisé est le cheval, surtout pour des raisons pratiques (contention facile, volume de sang circulant important, etc ...).

Bien que conceptuellement simple, le procédé de fabrication nécessite dorénavant de disposer d'une unité de production qui réponde aux normes GMP (pour *Good Manufacturing Process*). Les rendements de production dépendent largement de la manipulation et de l'élevage des chevaux et des animaux venimeux. Ainsi, la commercialisation de ces antivenins par les pays industrialisés diminue par manque de rentabilité. Elle est actuellement assurée dans les pays où sévissent ces accidents par des unités de productions locales qui relèvent souvent du Ministère en charge de la santé publique (qui subventionne ces produits pour répondre aux besoins nationaux). Très peu de publications émanent de ces structures de production concernant leur mode de préparation ou leur efficacité. En règle générale, les normes d'assurance qualité (AQ) et de contrôle qualité (CQ) suivent les recommandations européennes et celles de l'Organisation Mondiale de la Santé (OMS; Theakston *et al.*, 2003). Néanmoins, d'un pays à l'autre, les références ne sont pas identiques et les protocoles utilisés ne sont pas standardisés. Les méthodes de mesure des doses létales qui tuent 50% des animaux envenimés (DL50), de la capacité de neutralisation ou de protection d'un antivenin diffèrent considérablement et de ce fait rendent souvent impossible la comparaison de l'efficacité des produits pharmaceutiques proposés. Plusieurs équipes de recherche évaluent régulièrement et selon leurs standards, l'efficacité des produits pharmaceutiques commercialisés (Gutiérrez *et al.*, 2009), mais aucune structure à notre connaissance n'est pour l'instant considérée comme laboratoire de référence.

#### *Les antivenins d'origine équine : mode de préparations et spécificité*

Le mode de préparation des antivenins d'origine équine se fait classiquement selon un même procédé dans la plupart des pays. L'immunisation du cheval induit le développement d'une réponse immunologique plus ou moins développée d'un animal à l'autre et selon l'antigène en question. Les antivenins de cheval sont des sérums thérapeutiques fabriqués par fractionnement du plasma prélevé (*i.e.* plasmaphérèse) sur des chevaux, qui ont été immunisés contre le venin ou la fraction toxique d'un venin et dont l'organisme en réponse développe plusieurs sous-populations lymphocytaires productrices d'anticorps. A partir du sérum ou du plasma de cheval, les immunoglobulines totales sont d'abord précipitées et soumises à une digestion enzymatique (à la pepsine pour obtenir un fragment Fab'2 et un fragment Fc) ou à la papaine (pour obtenir deux fragments Fab et un fragment Fc). Les fragments de type Fab'2 polyclonaux sont de nouveau précipités et purifiés. Au total, les immunosérums récupérés à partir du sang périphérique subissent une série de traitements physiques, chimiques et enzymatiques. Le procédé de production de ces produits actuellement commercialisés est par conséquent lourd et coûteux.

La tolérance et l'efficacité des antivenins sont souvent évaluées par des études menées chez un modèle animal, en l'occurrence le lapin, la souris, le rat ou encore le chien. Généralement, ils sont administrés par voie intraveineuse (IV) ou intramusculaire (IM) et leur devenir est suivi en présence ou absence de venin ou toxine. Les méthodes de détermination de la pharmacocinétique des venins sont basées dans la plupart des travaux sur les injections des molécules radiomarquées ou par une quantification de leur concentration plasmique ou tissulaire par un ELISA sandwich (Rivière *et al.*, 1997; Krifi *et al.*, 2001, 2005).

Dans le cas particulier des toxines de scorpions, les études montrent qu'elles ont une absorption rapide à partir du site de l'injection, associée à une large distribution au niveau du compartiment extravasculaire. Leur temps de demi-vie est court et leur distribution plus précoce dans les tissus profonds et peu profonds (11 à 102 fois plus courtes que celles de l'antivenin). A titre d'exemple, l'antivenin SAS atteint une concentration maximale au niveau des tissus plus tardivement (*i.e.* plus de 45 min) que le venin scorpionique (*i.e.* moins de 30 min; Krifi *et al.*, 1998).

Selon la nature (formats IgG ou Fab'2) de l'antivenin, la pharmacocinétique diffère (*Figure 1*). Ainsi, les Fab et les Fab'2 ont un volume de distribution plus large que les IgGs. Leur clearance est également plus rapide. Il est admis que le potentiel pharmacodynamique, et par conséquent l'efficacité d'un antivenin, sont tributaires du format et des propriétés du format des anticorps considérés (Krifi *et al.*, 2001; Hammoudi-Triki *et al.*, 2007).

#### *Les antivenins produits chez le lapin et la souris*

Les antivenins de lapin et de souris ont été exclusivement préparés et utilisés comme outils moléculaires d'étude. Ainsi, des études immunobiochimiques utilisant des sérums polyclonaux de lapin ou de souris dirigés contre toute la fraction d'un venin ont été rapportées. Ces antivenins ont essentiellement servi à l'étude des variabilités intraspécifiques (El Hafni *et al.*, 2002).

### **Les antitoxines**

L'importance médicale d'un grand nombre de toxines a largement contribué à poser les fondements de l'immunologie et de l'immunothérapie spécifique. Elles ont permis le développement d'une recherche thérapeutique basée sur les anticorps d'origine animale (*i.e.* souris). La technologie des anticorps monoclonaux a donné un élan considérable au développement de l'immunothérapie antivenimeuse en général et en particulier à la caractérisation et à l'étude approfondie des mécanismes d'interactions moléculaires des complexes de type toxine/récepteur ou toxine/canal. Plusieurs ACM ont été générés chez la souris et leur capacité de neutralisation a été systématiquement déterminée *in vitro* vs *in vivo* (Estevao-Costa *et al.*, 2000; Alvarenga *et al.*, 2005).

Ces antitoxines ont permis de démontrer que les toxines appartiennent à des groupes antigéniques et structuraux différents et que des réactions antigéniques croisées entre les toxines d'un même groupe existent. Le nombre de sites épitopiques présents à la surface de certaines toxines a été depuis largement étudié et a permis de démontrer que la majorité de la surface accessible au solvant est antigénique (El Ayeb *et al.*, 1986).



A titre d'exemple, les toxines purifiées à partir de venins de scorpions du Nord de l'Afrique [*i.e.* *Androctonus australis hector* (Aah) et *Buthus occitanus tunetanus* (Bot)] ont été classées en trois groupes antigéniques: le groupe I contient AahI, AahII et AahIII; le groupe II contient AahII et BotIII, et le groupe III, BotI, BotII et les toxines homologues.

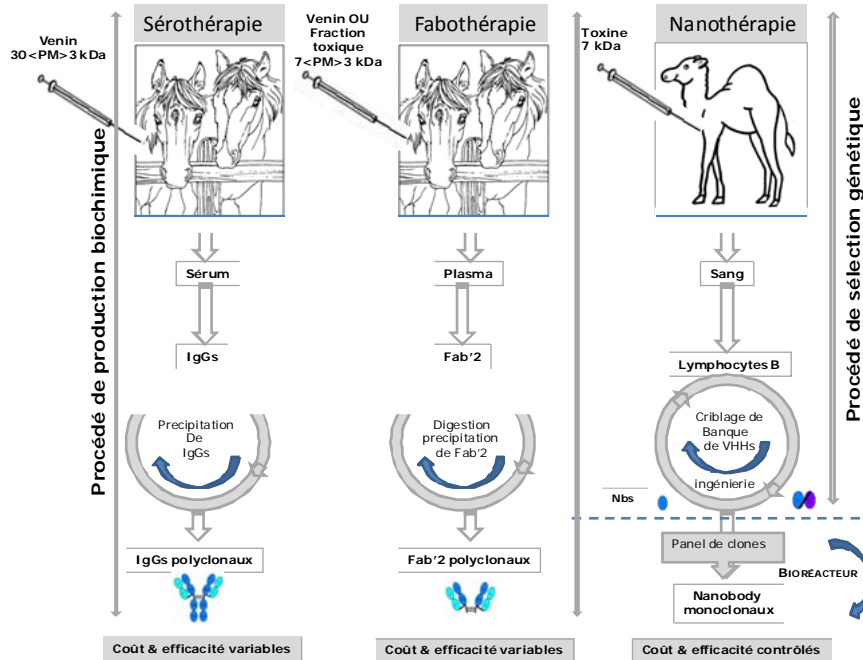

Figure 1. Schéma comparatif des différents procédés de préparation d'antivenins.

Figure 1. Antivenom production processes : comparative schemes.

Néanmoins, l'immunisation d'animaux par ces substances pour la production d'anticorps neutralisant rencontre divers problèmes inhérents à leur effet toxique. De plus, certaines toxines comme celles issues de venins de scorpions sont faiblement immunogènes, d'où les difficultés d'obtention d'hybridomes producteurs d'anticorps de haute affinité et de potentiel neutralisant. A titre indicatif, seuls trois ACM dirigés contre trois toxines de scorpions ont été rapportés comme hautement affins et neutralisants. Ces anticorps (*i.e.* 9C2, 4C1, BCF2) semblent se lier à un épitope conformationnel qui pourrait être employé pour détecter et identifier la toxine et donc un venin (Bahraoui *et al.*, 1988; Clot-Faybesse *et al.*, 1999; Selisko *et al.*, 1999). L'un des inconvénients majeurs de l'utilisation des ACM d'origine murine est leur forte immuno-réactivité induite chez l'Homme: des anticorps anti-souris sont produits en réponse dans l'organisme; d'une part, ils contribuent à réduire l'efficacité du produit et d'autre part, ils engendrent des effets secondaires.

## Les fragments d'anticorps antitoxines

La technologie des antitoxines et donc des antivenins s'est considérablement développée depuis le développement des techniques de l'ADN recombinant. Il est devenu possible de concevoir des fragments d'anticorps fonctionnels à partir du matériel génétique des hybridomes producteurs d'anticorps murins. La connaissance de la structure et de l'organisation des anticorps (domaines variables VH/VL et constants CH/VL; régions conservées FRs et hypervariables CDRs) et la maîtrise des outils du génie génétique appliqué à des fragments d'anticorps fonctionnels (Fab [pour *Fragment antigen-binding*], Fv [pour *Fragment variable*] et scFv [pour *single-chain variable Fragment*]) sont à l'origine de ce développement. Des anticorps chimériques à moitié d'origine humaine (Fab'2murin-Fc humain) ont été ainsi obtenus.

Au cours des deux dernières décennies de recherche internationales, les efforts se sont focalisés sur la production d'anticorps fonctionnels qui soient les moins immunogènes possible et les plus hautement spécifiques de manière à répondre aux conditions optimales d'utilisation chez l'Homme. L'enjeu est de mettre en pratique les récents savoir faire technologiques pour engendrer un large répertoire de diversité moléculaire clonée et pour obtenir une sélection ciblée des molécules selon les propriétés fonctionnelles de liaison et d'interactions recherchées. On distingue les fragments d'anticorps issus d'hybridomes et les fragments d'anticorps issus du criblage de banque combinatoires.

## Les fragments d'anticorps issus d'hybridomes

Les premiers fragments d'anticorps ont été développés à partir d'hybridomes d'origine murine conduisant à des scFv et des Fab. L'ADNc codant pour les domaines variables des chaînes H et L de l'anticorps (VH et VL) est utilisé pour former des fragments d'anticorps. Ces fragments sélectionnés peuvent également être soumis à des modifications par mutagenèse dirigée dans l'objectif de renforcer leur affinité et / ou leur stabilité.

Ainsi, les ARNm d'anticorps monoclonaux murins neutralisant les toxines ont d'abord été exploités pour développer des fragments scFv (Mousli *et al.*, 1999; Devaux *et al.*, 2001). Le format Fab, fragment de liaison à l'antigène conçu par certaines équipes (Licea *et al.*, 1996; Aubrey *et al.*, 2004), est parfois considéré comme une version plus fonctionnellement stable par rapport au scFv, comme dans le cas particulier des dérivés de l'ACM BCF2 (Quintero-Hernandez *et al.*, 2007). Leur évaluation fonctionnelle et surtout leur capacité de neutralisation (CN) ont été étudiées. Toutefois, les valeurs de CN sont calculées par différentes approches et sont par conséquent difficilement applicables pour comparer leur potentiel thérapeutique. En outre, les différences enregistrées selon la voie d'injection (intra péritonéale, intra cérébro-ventriculaire ou sous-cutanée) et la grande variabilité des toxines et anticorps compliquent les études comparatives et les rendent parfois inappropriées.

**Les fragments d'anticorps issus de banques combinatoires**

Plusieurs méthodes de criblage ont été optimisées pour l'obtention d'anticorps dont la stabilité, le niveau d'expression et l'affinité sont améliorés. L'approche "phage display", développée dès 1985 par Smith, consiste à construire des banques combinatoires d'ADNc permettant d'exposer des peptides recombinants sur la surface des particules phagiques, pour étudier leur interaction avec un ligand qui est souvent immobilisé sur une plaque en plastique permettant l'adsorption des protéines.

Ce système a évolué de sorte qu'il permet aujourd'hui de remplacer les protocoles habituels de vaccination des animaux ou la préparation d'hybridomes par un système bactérien capable de synthétiser des fragments d'anticorps contre un antigène donné. Les phages filamenteux, comme le M13, ont été largement utilisés pour développer différents types de banques de phages présentant à leur surface un peptide ou d'anticorps particulier. La création de banques de fragments de liaison antigénique de type scFv, et leur expression subséquente à la surface des phages, ont permis la sélection, grâce à un criblage et des étapes de sélection (« panning »), d'anticorps dont l'affinité et les propriétés pharmacocinétiques sont améliorées (Winter *et al.*, 1994; Batra *et al.*, 2002). Il est possible de multiplier les étapes de criblage et de restreindre d'un tour à l'autre les conditions de sélection de manière à ne sélectionner que les plus affins (Figure 2).

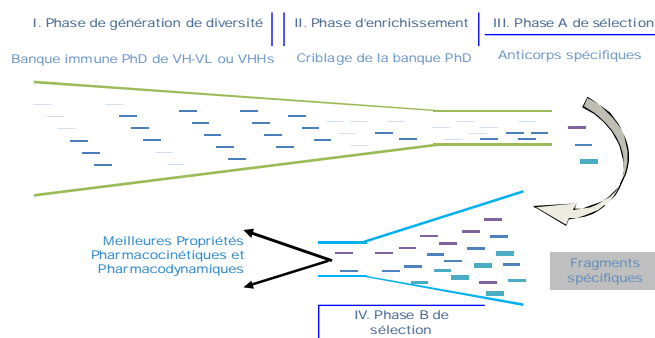

**Figure 2.** Stratégie schématique de sélection de fragment d'anticorps.  
**Figure 2.** Strategy of antibody fragment selection.

Cette stratégie combinée avec une approche *Error prone PCR* a été utilisée pour améliorer les capacités de neutralisation d'un scFv obtenu à partir du monoclonal BCF2. Cet anticorps scFv est capable de neutraliser l'effet de la toxine Cn2 issu du venin de scorpion *Centroides noxius*. De même, des variants ScFv à plus haute affinité et plus stables ont été générés (Selisko *et al.*, 2004; Juarez-Gonzalez *et al.*, 2005).

**Les antitoxines dérivées de Camélidés**

Une nouvelle alternative à la sérothérapie conventionnelle et à la fabothérapie a été récemment proposée. Elle combine l'utilisation de fragments d'anticorps de Camélidés (*i.e.* dromadaires et lama, Figure 3) et les approches de sélection par les phages. Le choix de cette alternative trouve son origine dans la découverte historique des anticorps à chaînes lourdes H-H ou HCAs des Camélidés (Hamers-Casterman *et al.*, 1993).



**Figure 3.** Camelus dromedarius du Sud tunisien (Kébili).  
**Figure 3.** Camelus dromedarius from Tunisia (Kébili region).

Ces anticorps sont dépourvus de chaînes légères (L) et sont composés uniquement d'un homodimère de chaînes lourdes (H-H). Fait intéressant, ils sont ainsi entièrement fonctionnels et leur domaine de liaison à l'antigène est constitué d'un domaine variable unique dénommé VHH (*Tableau 1*). Ces VHH ont une identité de séquence élevée avec les VH de la famille III, la famille la plus répandue chez l'Homme (Vu *et al.*, 1997). Leur séquence contient un nombre remarquable de substitutions au niveau des régions FR par comparaison à celle des VH conventionnels. Ces substitutions par des acides aminés plus hydrophiles sont concentrées au niveau de la surface hydrophobe de contact avec le VL exposé au solvant rendant le domaine VHH plus soluble (Muydermans *et al.*, 1994). Le VHH s'exprime à de hauts rendements d'expression dans des bactéries ou des levures (Thomassen *et al.*, 2005) et est bien tolérée chez la souris (Cortez-Retamozo *et al.*, 2002). En raison de leurs dimensions à l'échelle nanométrique (< 100 nm), les VHH sont également dénommés "Nanobodies".

**Tableau 1.** Comparaison de la taille et de la structure des différents formats d'anticorps rencontrés dans le monde des antivenins et antitoxines animales.

**Table 1.** Size and structure comparison of antibody formats worldwide collected from antivenoms and animal antitoxins.

Antivenin vs antitoxine	Taille	Structure
IgG de SAS et SAV équins	120-150 kDa	Hétérodimérique (2H-2L)
Fab'2 de SAS et SAV équins	95-100 kDa	Hétérodimérique (2VH/CH-2VL/CL)
IgG de lapin	120-150 kDa	Hétérodimérique (2H-2L)
ACM de souris	120-150 kDa	Hétérodimérique (2H-2L)
ScFv de souris	25-30 kDa	Hétéromérique (VH-VL)
Fab'2 de SAS et SAV équins	95-100 kDa	Hétérodimérique (2VH/CH-2VL/CL)
Tandem de Scfv de souris	50-60 kDa	Hétérodimérique (2VH/VL)
HC-IgG de camélidés	90-95 kDa	Homodimérique (H2)
"Nanobody" de camélidés	14-15 kDa	Monomérique (VHH)
"Nanobody" bispécifique de camélidés	25-30 kDa	Monomérique (VHH <sub>1</sub> -VHH <sub>2</sub> )
"Nanobody" bivalent de camélidés	25-30 kDa	Monomérique (VHH) <sup>2</sup>
AC chimérique de camélidés	95-100 kDa	Hétérodimérique (VHH-Fc) <sup>2</sup>
"Nanobody" humanisé au niveau des FR	14-15 kDa	Monomérique (hCDR-VHH)

### Avantages des "Nanobodies"

Les principaux avantages de l'utilisation des "Nanobodies" sont inhérents à leur petite taille, leur forme monomérique, leur solubilité élevée, leur robustesse et leur haut rendement qui en font des molécules bien plus facilement manipulables. Sur le plan moléculaire, le "Nanobody" reconnaît un antigène par seulement 3 boucles hypervariables CDR au lieu de 6 pour les fragments d'anticorps conventionnels. La longueur moyenne du CDR3 des VHH est supérieure à celle des VH conventionnels (*i.e.* 17 et 11 acides aminés respectivement). Par ailleurs, il a été démontré que les "Nanobodies", injectés par voie intraveineuse à des souris, sont distribués rapidement dans les tissus denses telles que les tumeurs ciblant leur antigène pendant une période prolongée alors que l'excès de "Nanobodies" libres est rapidement éliminé du sang par les reins (Cortez-Retamozo *et al.*, 2004). Dans différentes applications thérapeutiques, il a été signalé que les petites protéines stables (comme le scFv ou le "Nanobody") ont tendance à être faiblement immunogènes et donc plus adaptées à un ciblage tumoral (Willuda *et al.*, 1999). En effet, certains VHH administrés par voie orale montrent une bonne stabilité protéolytique et donc sont considérés comme résistants au transit par le tube digestif (Harmsen *et al.*, 2006, 2007). On considère que 60-80% de la surface de contact de l'antigène (De Genst *et al.*, 2005), est propre à la structure de la boucle CDR3 qui porte donc la majeure partie de la spécificité épitopique (De Genst *et al.*, 2006).

### Les "Nanobodies" antitoxines de scorpions

Dans le domaine de l'immunothérapie antiscorpionique, les HCABs de dromadaires immunisés se sont avérés capables de neutraliser les toxines de scorpion. Les lymphocytes de ces dromadaires préimmunisés ont été utilisés pour la construction, à partir des ARNm, de banques de VHH et la sélection d'un large panel de "Nanobodies" capables de neutraliser des toxines de scorpion (Meddeb-Mouelhi *et al.*, 2003; Hmila *et al.*, 2008; Ben Abderrazek *et al.*, 2009). Un large panel de séquences VHH a été ainsi obtenu. Les séquences ont été regroupées en fonction de leur similarité de séquences CDR3. En outre, ces travaux montrent que certains "Nanobodies" spécifiques présentent une capacité de neutralisation particulièrement élevée et jamais égalée auparavant. C'est le cas exceptionnel du NbAahIF12 dont la capacité de neutralisation (CN) avoisine les 100 DL50 de toxine spécifique (*i.e.* Aahl, Hmila *et al.*, 2010).

Selon une approche intéressante, utilisant des biocapteurs et des mesures de la résonance plasmonique de surface en temps réel, les sites épitopiques ont été cartographiés partiellement et ont révélé la complexité de

détermination par les constantes cinétiques ( $k_{on}$ ,  $k_{off}$  et  $KD$ ) des groupes de complémentation épitopique et par conséquent des corrélations possibles entre les CN, l'affinité et la conformation stérique. Toutefois, la représentation schématique déduite de cette étude est très intéressante et révèle également que le site épitope cible est l'élément crucial pour la neutralisation maximale. Ces travaux montrent que la stabilité et la cinétique de liaison sont importants et que la corrélation entre ces différentes propriétés avec la capacité de neutralisation est singulièrement complexe. De par leur grande stabilité, leur constante d'affinité *in vivo*, leur format simple et monomérique, ces "Nanobodies" s'avèrent particulièrement intéressants.

### Les dérivés de "Nanobodies" antitoxines de scorpions

Au cours des deux dernières décennies, l'ingénierie génétique des anticorps a conduit à la conception de nouveaux formats de liaison de l'antigène aux propriétés améliorées pour des utilisations plus adaptées au diagnostic et à la thérapeutique. Outre l'affinité et l'avidité, la pharmacocinétique est l'une des propriétés primordialement recherchées pour conduire à des applications des fragments d'anticorps.

En général, le fragment Fv (*i.e.* VH-VL) est le plus petit fragment d'anticorps qui garde la reconnaissance de l'antigène. Néanmoins, l'association des domaines VH et VL (scfv) conduit à une forme souvent instable en particulier à de faibles concentrations. Comme ces formats peuvent montrer une affinité réduite par rapport à la molécule d'IgG parentale, une approche par ingénierie est séquentiellement souvent entreprise, avec l'objectif d'en améliorer les propriétés pharmacologiques.

Dans une approche similaire, les "Nanobodies" spécifiques de toxines de scorpions (*i.e.* anti-Aahl et anti-AahlI) ont été utilisés pour construire des formats bivalents, bispécifiques et chimériques. Fait remarquable, le NbF12-10 réussit à neutraliser 5 DL50 de venin brut. Dans un modèle murin qui reproduit l'envenimation naturelle suivie d'un traitement thérapeutique, il a été démontré que moins de 100 µg de NbF12-10 suffisent à protéger les souris traitées contre une dose mortelle de venin de scorpion, même si les injections de venin sont répétées à trois reprises. Outre sa faible immunogénicité, il a été démontré que l'injection de NbF12-10 permet de sauver des souris présentant déjà des signes graves d'envenimation dans les cas de thérapie tardive (Hmila *et al.*, 2008, 2010).

Ce nouveau format d'anticorps semble donc présenter plusieurs propriétés bénéfiques par rapport aux fragments d'anticorps Fab'2 classiques, notamment pour neutraliser les venins de vipères (Harrison *et al.*, 2006; Cook *et al.*, 2010). Ces récentes publications soulignent les progrès qui pourraient être apportés pour une nouvelle génération de produits antivenimeux basée sur les "Nanobodies", que l'on appellera Nanothérapie (Figure 1). Moyennant de bons rendements de production (*i.e.* bonne pratique de fabrication BPF), ces produits devraient offrir une alternative efficace pour le traitement des patients envenimés dans les hôpitaux.

### Conclusion

L'immunothérapie actuelle est régulièrement remise en question. Les principales interrogations portent sur l'efficacité du sérum antivenimeux de cheval actuellement produit par les pays concernés par les problèmes liés à l'envenimation par piqûres ou morsures animales et les effets secondaires. Les délais avant l'administration de l'antivenin conditionnent largement leur efficacité. La fenêtre interventionnelle efficace est réduite à une ou deux heures après l'envenimation. Elle dépend essentiellement de la taille, de l'âge et du poids du patient. Il est clairement admis que, pour une efficacité maximale, une application rapide est nécessaire. Des études effectuées chez le lapin font état de la cinétique sérique du venin de scorpion après l'administration de sérum antivenimeux à des doses variables et selon les différentes voies d'injection (Krifi *et al.*, 2005; Hammoudi-Triki *et al.*, 2007). Il a été démontré que pour être efficace, la dose minimale efficace de fragments Fab'2 doit être administrée par voie IV.

Des données prometteuses ont été récemment rapportées et concernent de nouveaux produits présentant un rendement potentiel plus élevé et des paramètres immunologiques et pharmacologiques avantageux. Ces produits devront être testés *in vivo* sur une cohorte de plusieurs individus avant que tout essai clinique soit envisagé. Compte tenu de la haute immunoréactivité croisée et de la paraspecificité des venins et moyennant l'élaboration de formats polyvalents, la nanothérapie devrait aboutir à des produits dont la spécificité et l'efficacité serait régionale (*i.e.* Maghreb, Machreck). De toute évidence, une nouvelle génération de thérapeutiques très spécifiques et puissants est née pour neutraliser les venins de scorpion, même lorsqu'ils sont administrés à un stade tardif de l'envenimation. Leur production devrait être cohérente et reproductible à un coût compétitif.

**Remerciements.** Les auteurs remercient Dr Benlasfar Z. pour ses précieuses informations.

### Références

- Alvarenga LM, Machado de Avila RA, Amim PR, Martins MS, Kalapothakis E, de Lima ME (2005) Molecular characterization of a neutralizing murine monoclonal antibody against *Tityus serrulatus* scorpion venom. *Toxicon* **46**: 664–671
- Aubrey N, Muzard J, Christophe Peter J, Rochat H, Goyffon M, Devaux C, Billiald P (2004) Engineering of a recombinant Fab from a neutralizing IgG directed against scorpion neurotoxin Aahl, and functional evaluation versus other antibody fragments. *Toxicon* **43**: 233–241
- Bahraoui E, Pichon J, Muller JM, Darbon H, El Ayebe M, Granier C, Marvaldi J, Rochat H (1988) Monoclonal antibodies to scorpion toxins characterization and molecular mechanisms of neutralization. *J Immunol* **141**: 214–220
- Batra SK, Jain M, Wittel UA, Chauhan SC, Colcher D (2002) Pharmacokinetics and biodistribution of genetically engineered antibodies. *Curr Opin Biotechnol* **13**: 603–608

- Ben Abderrazek R, Hmila H, Vincke C, Benlasfar Z, Pellis M, Dabbek H, Saerens D, El Ayeb M, Muyldermans S, Bouhaouala-Zahar B (2009) Identification of potent Nanobodies to neutralize the most poisonous polypeptide from scorpion. *Biochem J* **424**: 263-272
- Bouaziz M, Bahloul M, Kallel H, Samet M, Ksibi H, Dammal H, Nouri Ben Ahmed M, Chtara K, Chelly H, Ben Hamida C, Reik N (2008) Epidemiological, clinical characteristics and outcome of severe scorpion envenomation in South Tunisia: multivariate analysis of 951 cases. *Toxicon* **52**: 918-926
- Clot-Faybessé O, Juin M, Rochat H, Devaux C (1999) Monoclonal antibodies against the *Androctonus australis hector* scorpion neurotoxin I: characterisation and use for venom neutralisation. *FEBS Lett* **458**: 313-318
- Cook DA, Owen T, Wagstaff SC, Kinne J, Wernery U, Harrison RA (2010) Analysis of camelid IgG for antivenom development: Serological responses of venom-immunised camels to prepare either monospecific or polyspecific antivenoms for West Africa. *Toxicon* **56**: 363-337
- Cortez-Retamozo V, Lauwereys M, Hassanzadeh GhG, Gobert M, Conrath K, Muyldermans S, De Baetselier P, Revets H (2002) Efficient tumor targeting by single-domain antibody fragments of camels. *Int J Cancer* **98**: 456-462
- Cortez-Retamozo V, Backmann N, Senter PD, Wernery U, De Baetselier P, Muyldermans S, Revets H (2004) Efficient cancer therapy with a Nanobody-based conjugate. *Cancer Res* **64**: 2853-2857
- De Genst E, Silence K, Ghahroudi M A, Decanniere K, Loris R, Kinne J, Wyns L, Muyldermans S (2005) Strong *in vivo* maturation compensates for structurally restricted H3 loops in antibody repertoires. *J Biol Chem* **280**: 14114-14121
- De Genst E, Silence K, Decanniere K, Conrath K, Loris R, Kinne J, Muyldermans S, Wyns L (2006) Molecular basis for the preferential cleft recognition by dromedary heavy-chain antibodies. *Proc Natl Acad Sci USA* **103**: 4586-4591
- Devaux C, Moreau E, Goyffon M, Rochat H, Billiald P (2001) Construction and functional evaluation of a single-chain antibody fragment that neutralizes toxin Aahl from the venom of the scorpion *Androctonus australis hector*. *Eur J Biochem* **268**: 694-702
- El Ayeb M, Bahraoui EM, Granier C, Rochat H (1986) Use of antibodies specific to define regions of scorpion alpha-alpha to study its interaction with its receptor site on the sodium channel. *Biochemistry* **25**: 6671-6678
- El Hafny B, Chgoury F, Adil N, Cohen N, Hassar M (2002) Intraspecific variability and pharmacokinetic characteristics of *Androctonus mauretanicus mauretanicus* scorpion venom. *Toxicon* **40**: 1609-1616
- Estevao-Costa MI, Martins MS, Sanchez EF, Diniz CR, Chavez-Olortegui C (2000) Neutralization of the hemorrhagic activity of *Bothrops* and *Lachesis* snake venoms by a monoclonal antibody against mutalysin-II. *Toxicon* **38**: 139-144
- Gordon D, Karbat I, Ilan N, Cohen L, Kahn R, Gilles N, Dong K, Stuhmer W, Tytgat J, Gurevitz M (2007) The differential preference of scorpion a-toxins for insect or mammalian sodium channels: Implications for improved insect control. *Toxicon* **49**: 452-472
- Gutiérrez JM, Lomonte B, León G, Alapegirón A, Flores-Díaz M, Sanz L (2009) Snake venomomics and antivenomics: proteomic tools in the design and control of antivenoms for the treatment of snakebite envenoming. *J Proteomics* **72**: 165-182
- Hamers-Casterman C, Atarhouch T, Muyldermans S, Robinson G., Hamers C, Songa EB, Bendahman N, Hamers R (1993) Naturally occurring antibodies devoid of light chains. *Nature* **363**: 446-448
- Hammoudi-Triki D, Lefort J, Rougeot C, Robbe-Vincent A, Bon C, Laraba-Djebari F, Choumet V (2007) Toxicocinetic and toxicodynamic analyses of *Androctonus australis hector* venom in rats: Optimization of antivenom. *Ther Toxicol Appl Pharm* **218**: 205-214
- Harmsen MM, van Solt CB, van Zijderveld-van Bommel AM, Niewold TA, van Zijderveld FG (2006) Selection and optimization of proteolytically stable llama single-domain antibody fragments for oral immunotherapy. *Appl Microbiol Biotechnol* **72**: 544-555
- Harmsen MM, De Haard HJ (2007) Properties, production, and applications of camelid single-domain antibody fragments. *Appl Microbiol Biotechnol* **77**: 13-22
- Harrison RA, Hasson SS, Harmsen M, Laing GD, Conrath K, Theakston RD (2006) Neutralisation of venom-induced haemorrhage by IgG from camels and llamas immunised with viper venom and also by endogenous, non-IgG components in camelid sera. *Toxicon* **47**: 364-368
- Harvey AL (1991) *Snake Toxins*. Pergamon Press: New York
- Hmila I, Ben Abderrazek-Ben Abdallah R, Saerens D, Benlasfar Z, Conrath K, El Ayeb M, Muyldermans S, Bouhaouala-Zahar B (2008) VHH, bivalent domains and chimeric Heavy chain-only antibodies with high neutralizing efficacy for scorpion toxin Aahl'. *Mol Immunol* **45**: 3847-3856
- Hmila I, Saerens D, Ben Abderrazek R, Vincke C, Abidi N, Benlasfar Z, Govaert J, El Ayeb M, Bouhaouala-Zahar B, Muyldermans S (2010) A bispecific Nanobody to provide full protection against scorpion envenomation. *FASEB J* **24**: 3479-3489
- Juarez-Gonzalez VR, Riano-Umbariala L, Quintero-Hernandez V, Olamendi-Portugal T, Ortiz-Leon M, Ortiz E, Possani LD, Becerril B (2005) Directed evolution, phage display and combination of evolved mutants: a strategy to recover the neutralization properties of the scFv version of BCF2 a neutralizing monoclonal antibody specific to scorpion toxin Cn2. *J Mol Biol* **346**: 1287-1297
- Krifi MN, Savin S, Debray M, Cassian B, El Ayeb M, Choumet V (2005) Pharmacokinetic studies of scorpion venom before and after antivenom immunotherapy. *Toxicon* **45**: 187-198
- Krifi MN, Kharrat H, Zghal K, Abdouli M, Abroug F, Bouchoucha S, Dellagi K, El Ayeb M (1998) Development of an ELISA for the detection of scorpion venoms in sera of humans envenomed by *Androctonus australis garzonii* (Aag) and *Buthus occitanus tunetanus* (Bot): correlation with clinical severity of envenoming in Tunisia. *Toxicon* **36**: 887-900
- Krifi MN, Miled K, Abderrazak M, El Ayeb M (2001) Effects of antivenom on *Buthus occitanus tunetanus* (Bot) scorpion venom pharmacokinetics: towards an optimization of antivenom immunotherapy in a rabbit model. *Toxicon* **39**: 1317-1326
- Krifi MN, Savin S, Debray M, Bon C, El Ayeb M, Choumet V (2005) Pharmacokinetic studies of scorpion venom before and after antivenom immunotherapy. *Toxicon* **45**: 187-198
- Licea AF, Becerril B, Possani LD (1996) Fab fragments of the monoclonal antibody BCF2 are capable of neutralizing the whole soluble venom from the scorpion *Centruroides noxius Hoffmann*. *Toxicon* **34**: 843-847
- Meddeb-Mouelhi F, Bouhaouala-Zahar B, Benlasfar Z, Hammadi M, Mejri T, Moslah M, Karoui H, Khorchani T, El Ayeb M (2003) Immunized camel sera and derived immunoglobulin subclasses neutralizing *Androctonus australis hector* scorpion toxins. *Toxicon* **42**: 785-791
- Mousli M, Devaux C, Rochat H, Goyffon M, Billiald P (1999) A recombinant single-chain antibody fragment that neutralizes toxin II from the venom of the scorpion *Androctonus australis hector*. *FEBS Lett* **442**: 183-188

- Muyldermans S, Atarhouch T, Saldanha J, Barbosat JA, Hamers C (1994) Sequence and structure of VH domain from naturally occurring camel heavy chain immunoglobulins lacking light chains. *Protein Eng* **7**: 1129-1135
- Organisation Mondiale de la Santé (1981) Progress in the characterization of venoms and standardization of antivenoms. WHO offset Publ.58
- Ozkan O, Carhan A (2008) The neutralizing capacity of *Androctonus crassicauda* antivenom against *Mesobuthus eupeus* scorpion venom. *Toxicon* **52**: 375-379
- Quintero-Hernandez V, Juarez-Gonzalez VR, Ortiz-Leon M, Sanchez R, Possani LD, Becerril B (2007) The change of the scFv into the Fab format improves the stability and *in vivo* toxin neutralization capacity of recombinant antibodies. *Mol Immunol* **44**: 1307-1315
- Rivière G, Choumet V, Audebert F, Sabouraud A, Debray M, Scherrmann JM, Bon C (1997) Effect of antivenom on venom pharmacokinetics in experimentally envenomed rabbits: toward an optimization of antivenom therapy. *J Pharmacol Exp Ther* **281**: 1-8
- Selisko B, Licea AF, Becerril B, Zamudio F, Possani LD, Horjales E (1999) Antibody BCF2 against scorpion toxin Cn2 from *Centruroides noxius hoffmanni*: primary structure and threedimensional model as free Fv fragment and complexed with its antigen. *Proteins* **37**: 130-143
- Selisko B, Cosío G, Garcia C, Becerril B, Possani LD, Horjales E (2004) Bacterial expression, purification and functional characterization of a recombinant chimeric Fab derived from murine mAb BCF2 that neutralizes the venom of the scorpion *Centruroides noxius hoffmanni*. *Toxicon* **43**: 43-51
- Servent D, Fruchart-Gaillard C (2009) Muscarinic toxins: tools for the study of the pharmacological and functional properties of muscarinic receptors. *J Neurochem* **109**: 1193-1202
- Smith GP (1985) Filamentous fusion phage: novel expression vectors that display cloned antigens on the virion surface. *Science* **228**: 1315-1317
- Soulaymani-Bencheikh R, Faraj Z, Semlali I, Khattabi A, Skalli S, Benkirane R (2002) Epidémiologie des piqûres de scorpion au Maroc. *Rev Epidemiol Sante Publique* **50**: 341-347
- Thomassen YE, Verkleij AJ, Boonstra J, Verrips CT (2005) Specific production rate of VHH antibody fragments by *Saccharomyces cerevisiae* is correlated with growth rate, independent of nutrient limitation. *J Biotechnol* **118**: 270-277
- Vu KB, Ghahroudi MA, Wyns L, Muyldermans S (1997) Comparison of llama VH sequences from conventional and heavy chain antibodies. *Mol Immunol* **34**: 1121-1131
- Willuda J, Honegger A, Waibel R, Schubiger PA, Stahel R, Zangemeister-Wittke U, Plückthun A (1999) High thermal stability is essential for tumor targeting of antibody fragments: engineering of a humanized anti-epithelial glycoprotein- 2 (epithelial cell adhesion molecule) single-chain Fv fragment. *Cancer Res* **59**: 5758-5767
- Winter G, Griffiths AD, Hawjins RE, Hoogenboom HR (1994) Making antibodies by phage display technology. *Ann Rev Immunol* **12**: 433-455
- Zlotkin E, Miranda F and Lissitzky S (1972) Proteins in scorpion venoms toxic to mammals and insects. *Toxicon* **10**: 207-208
-



## **Anticorps recombinants humanisés, issus de primates non humains, pour la neutralisation des toxines**

Philippe THULLIER, Siham CHAHBOUN, Jacques MATHIEU, Thibaut PELAT\*

Unité de biotechnologie des anticorps, et des toxines, Département de microbiologie, Institut de Recherche Biomédicale des Armées, La Tronche, France

\* Auteur correspondant ; Courriel : [t.pelat@orange.fr](mailto:t.pelat@orange.fr)

---

### **Résumé**

Les anticorps recombinants forment une classe thérapeutique en plein essor, pouvant participer à la prise en charge des pathologies induites par les toxines. Pour isoler de tels anticorps recombinants, nous utilisons une approche particulière de la technologie de référence du domaine, le « phage display ». Nos bibliothèques de fragments d'anticorps sont en effet construites à partir de primates non humains (*Macaca fascicularis*) immunisés, puis criblés pour en isoler les candidats les plus neutralisants. Les régions charpentes de ces meilleurs candidats sont ensuite humanisées par référence à des séquences germinales humaines. Une telle humanisation (appelée « germinalisation » ou « super-humanisation ») permet d'obtenir des fragments d'anticorps plus proches des séquences germinales humaines, donc du « soi immunologique » humain, que ceux rencontrés sous forme d'anticorps humains; ils devraient donc être mieux tolérés. Ces fragments d'anticorps sont ensuite exprimés en fusion avec des régions constantes d'IgG humaines, pour obtenir des anticorps entiers. Les anticorps ainsi obtenus comportent notamment des anticorps neutralisant la toxine létale du charbon (35PA<sub>83</sub>, 2LF) et la ricine (43RCA).

### **Non-human primate antibodies neutralizing toxins**

Recombinant antibodies constitute a highly successful class of therapeutic molecules, which could be utilized for the treatment of toxin-induced diseases. To isolate such recombinant antibodies, we utilize the "phage display" technology in a particular fashion. Indeed, our phage-displayed libraries of antibody fragments are built starting from immunized non-human primates (*Macaca fascicularis*), then screened to isolate the most neutralizing candidates. The framework regions of these best antibody fragments are then humanized by reference to their closest human germinal genes. This humanization (called "germinalisation" or "super-humanization") allows to obtain antibody fragments that are closer to these human germinal genes, thus closer to the human "immunological self", than antibody fragments encountered as part of human antibodies; hence, they should be better tolerated. These antibody fragments are later expressed in fusion with the constant regions of human IgGs, to obtain full-sized antibodies. In particular, antibodies neutralizing the anthrax lethal toxin (35PA<sub>83</sub>, 2LF) and ricin (43RCA) have been isolated.

**Keywords :** Antibodies, humanization, neutralization, non-human primates, toxin.

---

### **Introduction**

Les anticorps (Ac) recombinants sont obtenus par manipulation et expression contrôlée d'ADN, à la différence des Ac extraits du sang. Ils forment une classe thérapeutique récemment apparue (1997), dont l'utilisation a été exponentiellement croissante au point d'avoir représenté entre 5 et 10% des dépenses de médicaments en France en 2009, et dont la dernière génération est constituée d'Ac humains. La grande majorité de ces nouvelles molécules est destinée aux domaines de la cancérologie et des maladies inflammatoires, mais les essais cliniques actuels démontrent un intérêt croissant dans le domaine des agents anti-infectieux et des inhibiteurs de toxines (Pai *et al.*, 2009).

### **Intérêt des anticorps pour la neutralisation des toxines**

Le mécanisme de neutralisation des toxines est généralement simple, sans recrutement d'effecteurs immunitaires, et dépend surtout de l'inhibition de l'interaction de la toxine avec son récepteur cellulaire ou avec son substrat. Les effecteurs immunitaires pourraient toutefois jouer un rôle dans l'élimination des complexes Ac/toxines, qui reste mal connue. La capacité des anticorps à neutraliser des toxines a été illustrée dès 1890 avec les recherches menées par Behring et Kitasato sur les toxines de *Corynebacterium diphtheriae* et *Clostridium tetani*, qui ont ouvert la voie à la sérothérapie (Kantha, 1991). Aujourd'hui encore, des anticorps fréquemment polyclonaux et d'origine animale, dirigés contre des toxines bactériennes (Ourth, 1974; Ourth et



MacDonald, 1977; Kabura *et al.*, 2006; Smith, 2009) ou contre des venins (Dart et McNally, 2001; Dart *et al.*, 2001; Johnson *et al.*, 2008; Espino-Solis *et al.*, 2009), sont utilisés. Leur utilisation présente néanmoins plusieurs inconvénients majeurs : un risque d'induction de réaction d'hypersensibilité lorsque leur origine n'est pas humaine, une variabilité inter-lots de ces produits et un risque de transmission de maladies. L'utilisation d'anticorps extraits du sang humain diminue les risques d'hypersensibilité mais augmente l'éventualité de transmission de maladies, et est très généralement limitée par la faiblesse de la ressource. Des anticorps recombinants neutralisant les toxines, issus des techniques de la biologie moléculaire et codés par de l'ADN d'origine humaine, doivent donc être obtenus. Plusieurs stratégies peuvent être proposées pour obtenir ces Ac, mais la technique de sélection de fragments d'anticorps présentés à la surface de phages (technologie du « phage display ») continue d'être la référence dans ce domaine de travail. Cette technique repose sur le criblage de banques de fragments d'Ac exposés à la surface de particules phagiques, l'ADN codant pour le fragment d'Ac exposé étant intégré dans la particule. La sélection des fragments d'Ac spécifiques d'un antigène (Ag) est généralement réalisée par l'incubation de la banque contre l'Ag-cible adsorbé sur surface solide suivie de lavages, de façon répétée mais avec une stringence croissante. En particulier, le criblage de bibliothèques immunes humaines, obtenues à partir de lymphocytes d'individus immunisés, permet l'isolement de fragments d'anticorps humains de très haute affinité (Wild *et al.*, 2003).

### Obtention d'anticorps de primates non humains et humanisation

Au sein de l'Unité de biotechnologie des anticorps et des toxines (Institut de recherche biomédicale des armées, La Tronche) une variante de cette stratégie a été développée et consiste à immuniser des primates non-humains (PNH, ici de l'espèce *Macaca fascicularis*) par les agents d'intérêt, en remplacement des sujets humains. L'étape initiale d'immunisation est donc facilitée du double point de vue éthique et pratique (Pelat *et al.*, 2009b; Pelat et Thullier, 2009). Les Ac de PNH sont naturellement proches de leurs homologues humains, sans être identiques (Thullier *et al.*, 2010a; Thullier *et al.*, 2010b), et une étape particulière d'humanisation, appelée « germinalisation », peut leur être secondairement appliquée. Cette étape permet d'obtenir des régions variables d'Ac plus proches des séquences germinales humaines que les régions variables présentes dans les IgG humaines (Pelat *et al.*, 2008). Ce sont précisément ces séquences germinales qui codent les protéines du « soi immunologique », et non les séquences codant les IgG mutées durant la maturation d'affinité. Ces régions variables germinalisées sont exprimées en fusion avec des régions constantes d'IgG humaines, sous forme d'Ac entiers. Les Ac de PNH germinalisés pourraient donc être mieux tolérés que les Ac humains eux-mêmes (Pelat *et al.*, 2008; Pelat et Thullier, 2009).

### Neutralisation de la toxine létale du charbon par des fragments d'anticorps de primates non humains

La preuve de la capacité des Ac à neutraliser la majorité des agents du risque biologique militaire, en particulier certaines toxines (ricine, toxines botuliques en particulier), a été apportée par divers auteurs avec des anticorps d'origine animale (Foxwell *et al.*, 1985; Nowakowski *et al.*, 2002; Karginov *et al.*, 2004; Chen *et al.*, 2006; Hill *et al.*, 2006). Nous avons utilisé l'approche décrite ci-dessus pour obtenir des Ac recombinants ayant mêmes propriétés fonctionnelles que ces anticorps mais qui soient utilisables en médecine moderne, en commençant par des anticorps neutralisant des toxines (Thullier *et al.*, 2009). Après avoir démontré la capacité de notre approche à cibler la toxine tétanique (Chassagne *et al.*, 2004), nous avons cherché à neutraliser la toxine létale (LeTx), facteur essentiel de la pathogénicité de *Bacillus anthracis*, responsable du charbon. Deux fragments d'Ac de haute affinité (Tableau 1), l'un dirigé contre la sous-unité PA de cette toxine, 35PA<sub>83</sub> (Laffly *et al.*, 2005), et l'autre dirigé contre sa sous-unité LF, 2LF (Pelat *et al.*, 2007), ont été obtenus et neutralisent efficacement LeTx (Tableau 1). Les régions hypervariables de 35PA<sub>83</sub>, qui sont directement impliquées dans l'interaction avec l'antigène, ont été mutées pour augmenter l'affinité d'un facteur 20. Cette amélioration d'affinité a permis une amélioration des capacités de neutralisation se traduisant par une diminution de la CI<sub>50</sub> de 40% par rapport au Fab parental, dans le test standardisé *in vitro* (Laffly *et al.*, 2008).

### Humanisation d'un fragment d'anticorps de primate non humain

Comme il était attendu, le degré d'homologie entre les séquences de 35PA<sub>83</sub> et les séquences des Ac humains est élevé, mais il persiste des différences pouvant être à l'origine d'une immunogénicité potentielle de cet Ac chez l'Homme (Thullier *et al.*, 2010a; Thullier *et al.*, 2010b). Une étape d'humanisation germinale des régions charpentes de 35PA<sub>83</sub> a donc été effectuée, avec succès. L'outil d'analyse IMGT/V-QUEST (Giudicelli *et al.*, 2004) a montré que ces régions, d'une longueur totale de 178 résidus, contiennent 22 résidus différents de ceux qui sont présents dans les régions charpentes codées par des gènes germinaux humains, soit un pourcentage d'identité (appelé index de germinalité (GI)) de 87,6%. Grâce à ce travail d'humanisation germinale, ou « germinalisation », ce nombre a été réduit à 4, sans altérer l'affinité du Fab. Ces 4 résidus qui ne sont pas d'origine humaine sont toutefois trop éloignés les uns des autres pour constituer un épitope, et être immunogènes. Ainsi, les régions charpentes du variant germinalisé 35PA<sub>83</sub> sont codées à 97,7% par des gènes germinaux humains, soit un GI très nettement supérieur au GI du Fab parental. Cette valeur est aussi supérieure à celle d'un Fab anti-PA aux propriétés équivalentes à 35PA<sub>83</sub> mais qui est issu d'une librairie immune humaine, le Fab 83K7C, dont le GI n'est que de 91,1% (Wild *et al.*, 2003). Le GI élevé du variant germinalisé de 35PA<sub>83</sub>, qui signe sa proximité avec les séquences germinales appartenant donc au « soi immunologique » humain, prédit l'excellente tolérance de ce variant (Pelat *et al.*, 2008). Cette tolérance est même potentiellement meilleure que celle des anticorps humains, puisque la proximité avec les séquences germinales est plus grande, et ceci justifie le terme de « super-humanisation » applicable à cette humanisation

germinale. L'analyse des séquences de 35PA<sub>83</sub> et de ses variants par un second outil récemment développé, et qui permet d'évaluer la « nature humaine » d'un Ac par le calcul des G- ou H-scores, a confirmé ces résultats (Thullier *et al.*, 2010b).

### Expression et essais *in vivo* d'une IgG entière neutralisant la toxine du charbon

L'IgG dérivée de 35PA<sub>83</sub> par fusion avec des régions constantes d'IgG humaine a été obtenue par collaboration avec un partenaire industriel, le Laboratoire Français du Fractionnement et des Biotechnologies (LFB, Les Ulis, France), et s'est avérée très efficace pour la prophylaxie et le traitement de la maladie du charbon dans un modèle murin de la maladie. De plus, chez le lapin, l'injection de 2,5 mg/kg de cette IgG, de façon concomitante à l'infection intranasale par 100 DL<sub>50</sub> de la souche virulente 9602 de *Bacillus anthracis* (Berthier *et al.*, 1996), a permis de protéger la totalité des animaux. Cette dose est nettement plus petite que celle - égale à 40 mg/kg - qui est nécessaire pour atteindre un résultat équivalent avec le Raxibacumab®, l'IgG recombinante d'origine humaine anti-PA (Laird et Gentz, 2009; Mazumdar, 2009; Migone *et al.*, 2009) actuellement stockée dans les réserves stratégiques américaines (US Strategic National Stockpile) (Antoniou, 2010).

### Application de notre stratégie à la neutralisation d'autres toxines

Notre approche nous a permis de cibler une autre toxine d'intérêt militaire, la ricine. Un fragment d'Ac neutralisant cette toxine, 43RCA, a été isolé (Pelat *et al.*, 2009a). L'affinité de 43RCA, mesurée à 41 pM (Tableau 1), est une des meilleures affinités actuellement obtenues sans étape de maturation d'affinité *in vitro*. Un variant germinalisé de 43RCA présentant un GI de 97,5% a été obtenu. *In vivo*, l'IgG dérivée de 43RCA s'est avérée efficace pour le traitement de l'intoxication pulmonaire par la ricine dans un modèle murin (Pr Kam-Meng Tchou-Wong, New York University Medical Center, communication personnelle), et des premiers essais utilisant la ricine et l'IgG aérosolisées ont été réalisés : tous les animaux traités deux heures après l'intoxication ont survécu, ainsi que 80% de ceux traités 4 heures après l'intoxication (expérimentations en cours). Nos travaux actuels portent sur la neutralisation des toxines botuliques, dans le cadre d'un projet financé par des fonds européens, AntiBotABE.

**Tableau 1.** Caractéristiques de certains fragments d'anticorps isolés par l'Unité de biotechnologie des anticorps, et des toxines. Les gènes germinaux V (D) et J humains les plus proches de chaque fragment d'anticorps sont identifiés par l'utilisation de l'outil IMGT/V-QUEST (Giudicelli *et al.*, 2004). L'index de germinalité (GI) est défini comme le pourcentage d'identité entre les régions charpentes d'un Ac avec ses homologues codés par les gènes germinaux V (D) J humains les plus proches.

**Table 1.** Characteristics of antibody fragments isolated by Unité de biotechnologie des anticorps, et des toxines. The V (D) and J human germinal genes most similar to each antibody fragment were identified by IMGT/V-QUEST tool (Giudicelli *et al.*, 2004). The germinality index (GI) of an antibody is defined as the percent of identity between its frameworks with their counterparts coded by the closest human germinal V (D) J genes.

IMGT/V-QUEST						
clone	Chain	V	(D)	J	Affinité (M)	GI
6ATT (modèle)	VH	IGHV4-28*01	IGHD3-03*02	IGHJ4*02	0,4.10 <sup>-9</sup>	93%
	VL	IGKV1-09*01	/	IGKJ4*01		
35PA83	VH	IGHV4-59*01	IGHD3-3*01	IGHJ5*01	3,47.10 <sup>-9</sup>	88%
	VL	IGKV1-13*02	/	IGKJ3*01		
2LF	VH	IGHV3-30*04	IGHD3-10*01	IGHJ3*02	1,02.10 <sup>-9</sup>	84%
	VL	IGKV1-12*01	/	IGKJ4*01		
43RCA	VH	IGHV3-11*01	IGHD5-12*01	IGHJ4*02	41.10 <sup>-12</sup>	89%
	VL	IGKV1-09*01	/	IGKJ4*01		

### Conclusion

Ainsi, l'approche développée par notre unité a permis d'obtenir des Ac à visée thérapeutique ou prophylactique, neutralisant 2 des 6 principaux agents du risque biologique provoqué. Grâce à la flexibilité de cette approche, l'isolement d'Ac dirigés contre les autres agents majeurs du risque biologique provoqué est concevable, et pourrait aboutir à une amélioration significative de la prise en charge de ce risque. Au-delà des objectifs militaires de notre laboratoire, cette approche peut notamment s'étendre à l'isolement d'IgG dirigées contre d'autres toxines, par exemple celles qui sont secrétées par *Clostridium difficile* 027 (ICD 027) (Tachon *et al.*, 2006; Leav *et al.*, 2010; Lowy, 2010) ou par *Staphylococcus aureus* (Durand *et al.*, 2006; Libert *et al.*, 2009; Tilahun *et al.*, 2010). D'autres antigènes, y compris de nature humaine (marqueur cellulaire, cytokines), pourraient aussi être ciblés par notre approche.

### Références

- Antoniou SA (2010) Raxibacumab for inhalational anthrax: an effective specific therapeutic approach? *Expert Opin Investig Drugs* **19**: 909-911
- Berthier M, Fauchere JL, Perrin J, Grignon B, Oriot D. (1996) Fulminant meningitis due to *Bacillus anthracis* in 11-year-old girl during Ramadan. *Lancet* **347**: 828

- Chassagne S, Laffly E, Drouet E, Herodin F, Lefranc MP, Thullier P (2004) A high-affinity macaque antibody Fab with human-like framework regions obtained from a small phage display immune library. *Mol Immunol* **41**: 539-546
- Chen Z, Earl P, Americo J, Damon I, Smith SK, Zhou YH, Yu F, Sebrell A, Emerson S, Cohen G, *et al.* (2006) Chimpanzee/human mAbs to vaccinia virus B5 protein neutralize vaccinia and smallpox viruses and protect mice against vaccinia virus. *Proc Natl Acad Sci USA* **103**: 1882-1887
- Dart RC, McNally J (2001) Efficacy, safety, and use of snake antivenoms in the United States. *Ann Emerg Med* **37**: 181-188
- Dart RC, Seifert SA, Boyer LV, Clark RF, Hall E, McKinney P, McNally J, Kitchens CS, Curry SC, Bogdan GM, *et al.* (2001) A randomized multicenter trial of crotalinae polyvalent immune Fab (ovine) antivenom for the treatment for crotaline snakebite in the United States. *Arch Intern Med* **161**: 2030-2036
- Durand G, Bes M, Meugnier H, Enright MC, Forey F, Liassine N, Wenger A, Kikuchi K, Lina G, Vandenesch F, *et al.* (2006) Detection of new methicillin-resistant *Staphylococcus aureus* clones containing the toxic shock syndrome toxin 1 gene responsible for hospital- and community-acquired infections in France. *J Clin Microbiol* **44**: 847-853
- Espino-Solis GP, Riano-Umbarila L, Becerril B, Possani LD (2009) Antidotes against venomous animals: state of the art and perspectives. *J Proteomics* **72**: 183-199
- Foxwell BM, Detre SI, Donovan TA, Thorpe PE (1985) The use of anti-ricin antibodies to protect mice intoxicated with ricin. *Toxicology* **34**: 79-88
- Giudicelli V, Chaume D, Lefranc MP (2004) IMGT/V-QUEST, an integrated software program for immunoglobulin and T cell receptor V-J and V-D-J rearrangement analysis. *Nucleic Acids Res* **32**: W435-440
- Hill J, Eyles JE, Elvin SJ, Healey GD, Lukaszewski RA, Titball, RW (2006) Administration of antibody to the lung protects mice against pneumonic plague. *Infect Immun* **74**: 3068-3070
- Johnson PN, McGoodwin L, Banner W Jr (2008) Utilisation of Crotalidae polyvalent immune fab (ovine) for Viperidae envenomations in children. *Emerg Med J* **25**: 793-798
- Kabura L, Ilibagiza D, Menten J, Van den Ende J (2006) Intrathecal vs. intramuscular administration of human antitetanus immunoglobulin or equine tetanus antitoxin in the treatment of tetanus: a meta-analysis. *Trop Med Int Health* **11**: 1075-1081
- Kantha SS (1991) A centennial review; the 1890 tetanus antitoxin paper of von Behring and Kitasato and the related developments. *Keio J Med* **40**: 35-39
- Karginov VA, Robinson TM, Riemenschneider J, Golding B, Kennedy M, Shiloach J, Alibek K (2004) Treatment of anthrax infection with combination of ciprofloxacin and antibodies to protective antigen of *Bacillus anthracis*. *FEMS Immunol Med Microbiol* **40**: 71-74
- Laffly E, Danjou L, Condemine F, Vidal D, Drouet E, Lefranc MP, Bottex C, Thullier P (2005) Selection of a macaque Fab with framework regions like those in humans, high affinity, and ability to neutralize the protective antigen (PA) of *Bacillus anthracis* by binding to the segment of PA between residues 686 and 694. *Antimicrob Agents Chemother* **49**: 3414-3420
- Laffly E, Pelat T, Cedrone F, Blesa S, Bedouelle H, Thullier P (2008) Improvement of an antibody neutralizing the anthrax toxin by simultaneous mutagenesis of its six hypervariable loops. *J Mol Biol* **378**: 1094-1103
- Laird C, Gentz M (2009) Antibodies against protective antigen – I. Human Genome Sciences (ed). United States
- Leav BA, Blair B, Leney M, Knauber M, Reilly C, Lowy I, Gerding DN, Kelly CP, Katchar K, Baxter R, *et al.* (2010) Serum anti-toxin B antibody correlates with protection from recurrent *Clostridium difficile* infection (CDI). *Vaccine* **28**: 965-969
- Libert N, Batjorn E, Cirodde A, de Rudnicki S, Grasser L, Borne M, Brinquin L (2009) [Antitoxin treatments for necrotizing pneumonia due to Pantone-Valentine leukocidin-secreting *Staphylococcus aureus*]. *Med Mal Infect* **39**: 14-20
- Lowy FD (2010) Mapping the distribution of invasive *Staphylococcus aureus* across Europe. *PLoS Med* **7**: e1000205
- Mazumdar S (2009) Raxibacumab. *Mabs* **1**: 531-538
- Migone TS, Subramanian GM, Zhong J, Healey LM, Corey A, Devalaraja M, Lo L, Ullrich S, Zimmerman J, Chen A, *et al.* (2009) Raxibacumab for the treatment of inhalational anthrax. *N Engl J Med* **361**: 135-144
- Nowakowski A, Wang C, Powers DB, Amersdorfer P, Smith TJ, Montgomery VA, Sheridan R, Blake R, Smith LA, Marks JD (2002) Potent neutralization of botulinum neurotoxin by recombinant oligoclonal antibody. *Proc Natl Acad Sci USA* **99**: 11346-11350
- Ourth DD (1974) Neutralization of diphtheria toxin by human immunoglobulin classes and subunits. *Immunochemistry* **11**: 223-225
- Ourth DD, MacDonald AB (1977) Neutralization of tetanus toxin by human and rabbit immunoglobulin classes and subunits. *Immunology* **33**: 807-815
- Pai JC, Sutherland JN, Maynard JA (2009) Progress towards recombinant anti-infective antibodies. *Recent Pat Antiinfect Drug Discov* **4**: 1-17
- Pelat T, Bedouelle H, Rees AR, Crennell SJ, Lefranc MP, Thullier P (2008) Germline humanization of a non-human primate antibody that neutralizes the anthrax toxin, by *in vitro* and *in silico* engineering. *J Mol Biol* **384**: 1400-1407
- Pelat T, Hust M, Hale M, Lefranc MP, Dubel S, Thullier P (2009a) Isolation of a human-like antibody fragment (scFv) that neutralizes ricin biological activity. *BMC Biotechnol* **9**: 60
- Pelat T, Hust M, Laffly E, Condemine F, Bottex C, Vidal D, Lefranc MP, Dubel S, Thullier P (2007) High-affinity, human antibody-like antibody fragment (single-chain variable fragment) neutralizing the lethal factor (LF) of *Bacillus anthracis* by inhibiting protective antigen-LF complex formation. *Antimicrob Agents Chemother* **51**: 2758-2764
- Pelat T, Hust M, Thullier P (2009b) Obtention and engineering of non-human primate (NHP) antibodies for therapeutics. *Mini Rev Med Chem* **9**: 1633-1638
- Pelat T, Thullier P (2009) Non-human primate immune libraries combined with germline humanization: an (almost) new, and powerful approach for the isolation of therapeutic antibodies. *Mabs* **1**: 377-381
- Smith LA (2009) Botulism and vaccines for its prevention. *Vaccine* **27 Suppl 4**: D33-39
- Tachon M, Cattoen C, Blanckaert K, Poujol I, Carbonne A, Barbut F, Petit JC, Coignard B (2006) First cluster of *C. difficile* toxinotype III, PCR-ribotype 027 associated disease in France: preliminary report. *Euro Surveill* **11**: E060504 060501

- Thullier P, Chahboun S, Pelat T (2010a) A comparison of human and macaque (*Macaca mulatta*) immunoglobulin germline V regions, and its implications for antibody engineering. *Mabs* **2**: 528-538
- Thullier P, Huish O, Pelat T, Martin AC (2010b) The humanness of macaque antibody sequences. *J Mol Biol* **396**: 1439-1450
- Thullier P, Pelat T, Vidal D (2009) Recombinant antibodies against bioweapons. *Med Sci (Paris)* **25**: 1145-1148
- Tilahun ME, Rajagopalan G, Shah-Mahoney N, Lawlor RG, Tilahun AY, Xie C, Natarajan K, Margulies DH, Ratner DI, Osborne BA, *et al.* (2010) Potent neutralization of staphylococcal enterotoxin B by synergistic action of chimeric antibodies. *Infect Immun* **78**: 2801-2811
- Wild MA, Xin H, Maruyama T, Nolan MJ, Calveley PM, Malone JD, Wallace MR, Bowdish KS (2003) Human antibodies from immunized donors are protective against anthrax toxin *in vivo*. *Nat Biotechnol* **21**: 1305-1306
-



## Functional assays for toxins of the CBRN threats

Eric EZAN\*, François BECHER, Elodie DURIEZ

CEA, iBiTec-S, Service de Pharmacologie et d'Immunoanalyse, F-91191 Gif sur Yvette, France

\* Corresponding author ; Tel : +33 (0)1 6908 7350 ; Fax : +33 (0)1 6908 5907 ; E-mail : [eric.ezan@cea.fr](mailto:eric.ezan@cea.fr)

---

### Abstract

The development of rapid and accurate detection methods for toxins is required. Many detection methods targeting the entire organism producing the toxins are based on the nucleic acid amplification. Other techniques involve immunoassays or mass spectrometry which target either the whole microorganism or a specific toxic component. Although these methods are sensitive, they may lack of specificity and there is a need of confirmation techniques. Numerous toxins consist of a component that binds to cell surfaces and a catalytic unit that modifies cell homeostasis leading to deleterious effects in cell targets. Owing to the exquisite specificity and high catalytic activity of their enzymatic components, there is considerable interest in using these activities as a mean to monitor infection in biological fluids and in various environmental media. The assays are based on the reaction of the toxin with its specific substrate and the monitoring of the reaction product through mass spectrometry or enzyme immunoassay. In this context, we have applied this strategy to ricin from *Ricinus communis*, botulinum toxins from *Clostridium botulinum* and lethal and edema factors from *Bacillus anthracis*.

### Des tests fonctionnels pour les toxines des menaces CBRN

La détection de toxines associées à la menace terroriste ou environnementale nécessite des techniques complémentaires basées sur l'immunoanalyse, la spectrométrie de masse ou l'amplification des gènes par réaction de polymérase. Ces méthodes sont le plus souvent sensibles mais ne permettent pas de détecter l'activité fonctionnelle de ces toxines. Dans cet article, nous proposons des techniques alternatives qui consistent à mesurer indirectement la présence de ces toxines par leur activité catalytique. Nous présenterons des approches appliquées aux toxines de *Clostridium botulinum*, de l'anthrax et de la ricine.

**Keywords :** Biological activity, mass spectrometry, toxin.

---

## Introduction

Numerous toxins consist of a component that binds to cell surfaces and a catalytic unit that modifies cell homeostasis, resulting in deleterious effects on cell targets. The exquisite specificity of their enzymatic components and high turnover provide the basis for the development of assays for pharmacological study of these toxins. Since these toxins or their expression vector are also considered as potential terrorist weapons, there is considerable interest in using these activities as a means to monitor infection in human plasma as well as the biological threat in various environmental media (Demirev *et al.*, 2008). For instance, this was applied to the development of bioassays for botulism toxins and anthrax toxins with the lowest limit of detection in the pico- and femtomolar range. Botulinum neurotoxins (BoNTs/A-G) produced by the genus *Clostridium* are responsible for the paralytic illness botulism, and are one of the most toxic bioweapons. Because of this extreme toxicity, their availability and ease of preparation, BoNTs have been identified as a major biothreat agent. Therefore, in suspected intentional contamination, analytical techniques for prompt detection and diagnosis are essential, and must identify the causal agent rapidly to expedite suitable confinement and treatment.

Currently, the widely accepted test for the identification of BoNTs in both clinical specimens and food is the mouse bioassay. Its main advantage is sensitivity, with detection of 10 to 20 pg/mL of toxin, which is estimated to correspond to 1 mouse LD<sub>50</sub> (Sharma *et al.*, 2005). However, although mice often exhibit signs of botulism within a few hours after a BoNT sample injection, 4 days are required to confirm a negative result. There is clearly a place for alternative *in vitro* assays. One strategy has been to make use of the catalytic activity carried by the light chain of the toxin. BoNTs are composed of two chains, a heavy chain (≈100 kDa) and a light chain (≈50 kDa) held together by a disulfide bond (Montecucco *et al.*, 1995). The heavy chain is responsible for binding to the presynaptic membrane and translocation of the light chain into the cytosol of neuronal cells. The light chain cleaves specific proteins (SNAP-25, VAMP, syntaxin) involved in forming the soluble N-ethylmaleimide-sensitive fusion attachment protein receptor (SNARE) complex (Eswaramoorthy *et al.*, 2004). This complex is required for fusion of the synaptic vesicle with the presynaptic plasma membrane and communication between neurons. Protein cleavage by BoNTs has been exploited for the development of

sensitive *in vitro* assays, using peptide substrates mimicking the natural target of BoNTs. Peptide cleavage has been monitored either by fluorimetry or ELISA (Sharma *et al.*, 2006). Recently, it has been demonstrated that mass spectrometry is an alternative that can differentiate toxin types specifically (Endopep-MS assay). Each BoNT type cleaves a unique site on substrate peptides, generating products with different masses. Based on MALDI-TOF or LC-ESI-MS/MS analysis of the product fragments, the Endopep-MS assay differentiates all seven BoNTs (A, B, C, D, E, F and G types). Sensitivity of between 0.039 to 0.625 LD<sub>50</sub>/mL in buffer samples, so better than that of the mouse assay, was demonstrated for types A, B, E and F (Boyer *et al.*, 2005). This Endopep-MS assay has been applied to environmental and clinical samples, using an antibody capture step to purify and concentrate the toxins (Kalb *et al.*, 2009).

*Bacillus anthracis*, which causes anthrax, is another major agent considered in CBRN (chemical, biological, radiological, and nuclear) risk management, notably because of its ease of diffusion as spores, the high mortality (close to 100%) of inhalation anthrax, and the nonspecific symptoms of gastrointestinal anthrax and inhalation anthrax, which delay diagnosis. Anthrax toxin comprises three proteins that together account for its virulence: protective antigen (PA), a common component in receptor binding and internalization of two enzymatically active moieties — a metalloprotease (lethal factor, LF) and an adenylate cyclase (edema factor, EF). Diagnostic techniques designed for use when *Bacillus anthracis* infection is suspected include detection of the bacteria by phenotypic (API strips, morphological characteristics of cultured colonies) or genomic (real-time PCR) methods, or toxin detection. Toxins in serum can be quantified by Western blot (Molin *et al.*, 2008) or more sensitively by ELISA (Mabry *et al.*, 2006). Antibodies to PA or EF can also be detected by an indirect by ELISA (Quinn *et al.*, 2002; Sirisanthana *et al.*, 1988; Biagini *et al.*, 2004).

Indirect detection of *B. anthracis* in serum has been developed, based on the activity of EF and LF, a zinc endoprotease, which acts on the N-terminal part of six mitogen-activated protein kinase kinases (Vitale *et al.*, 2000). Its action blocks the signaling pathway and deregulates production of cytokines. EF is an adenylate cyclase, which catalyzes the transformation of adenosine triphosphate (ATP) to cyclic adenosine monophosphate (cAMP), in the presence of calmodulin and calcium. This excess of cAMP results in edema. These two enzymes have high catalytic activities (Turk *et al.*, 2004; Drum *et al.*, 2000), which explains the potential gain in sensitivity when using an activity-based assay (Duriez *et al.*, 2009).

## Application to ricin

Ricin is a toxic protein found in the seeds of the castor oil plant, *Ricinus communis*, at concentrations ranging from 1 to 5% and was first isolated by Stillmark in 1888 (Lord *et al.*, 1994). Ricin constitutes a substantial risk because of its toxicity, widespread availability and ease of extraction. There are no precise toxicological data on ricin, and its toxicity has been assessed in humans from domestic and industrial accidents, cases of suicide or murder by ingestion, inhalation or injection, and also in animal studies. In humans, the estimated lethal dose is 1 mg by ingestion, 1 µg/kg by injection and 5 to 10 µg/kg by inhalation, which is a wide range of LD<sub>50</sub> (Bradberry *et al.*, 2003). The Centers for Disease Control and Prevention in Atlanta put ricin in category B because there is currently no specific treatment for exposure to it, just treatments of signs and symptoms (Burnett *et al.*, 2005). Given its toxicity at low doses, ricin is a potential bioterrorism agent and was, for example, used to murder the Bulgarian journalist Georgi Markov in London in 1978, by injection of about 500 µg (*i.e.* equivalent of 5 seeds) (Crompton *et al.*, 1980). Ricin binds to eukaryotic cells by its B chain, a lectin which binds to terminal β-D-galactopyranose residues of cell surface glycolipids and glycoproteins (Olsnes *et al.*, 2001). After binding, ricin is internalized by clathrin-dependent endocytosis and is transported to an intracellular compartment of the Golgi apparatus. Once in the cytosol, the A chain, which has toxic activity, catalyzes the cleavage of the N-glycoside bond of adenosine 4324, specific to the GAGA sequence of the 28S ribosomal RNA of the large eukaryotic 60S subunit. As rRNA is modified, protein synthesis is stopped, and this leads to apoptosis of the cell.

Various analytical methods have been developed to detect and quantify ricin: ELISA (Yan-Kenigsberg, 2008) or mass spectrometry (Kalb *et al.*, 2009; Duriez *et al.*, 2009). As an alternative we have exploited the enzymatic activity of ricin to develop a functional assay (*i.e.* able to monitor the biological activity of ricin) method reaching the sensitivity of the best ELISA, *i.e.* at least 0.1 ng/mL (Becher *et al.*, 2007).

## Functional assay for ricin

Using appropriate sample preparation and optimized detection based on N-glycosidase activity, we demonstrate that specific detection of whole ricin at a level of around 0.1 ng/mL is possible and applicable to environmental samples. Our objective has been to develop a biochemical method of detection specific to functional ricin, *i.e.* whole ricin with N-glycosidase activity. In comparison with existing methods, additional specificity has been provided by the combined use of mass spectrometry and immunocapture using antibodies directed against the B chain of ricin. Immunocapture also extracts and concentrates ricin from complex samples. In the event of a bioterror, the response time is vital, and special attention has been paid to minimizing the overall analysis time. The first step of the assay consists of specific capture of ricin by its B chain (Figure 1), on magnetic beads coated with antibodies. The captured ricin is then incubated with a 14 mer RNA substrate containing the GAGA sequence and mimicking the natural RNA ribosomal substrate of the toxin. Finally, detection is based upon the LC/MS/MS analysis of adenine released by the ricin A chain. Our ultimate aim of this method is to detect ricin in complex biological or environmental samples, which often contain abundance of proteins and enzymes that degrade nucleic acids (*i.e.* RNase, DNase) and may interfere with detection. So, sample treatment is needed to

extract the ricin from complex samples. The advantage of immunoaffinity extraction is that it increases specificity for RIPs, compared with the abovementioned methods of detection (Keener *et al.*, 2006).

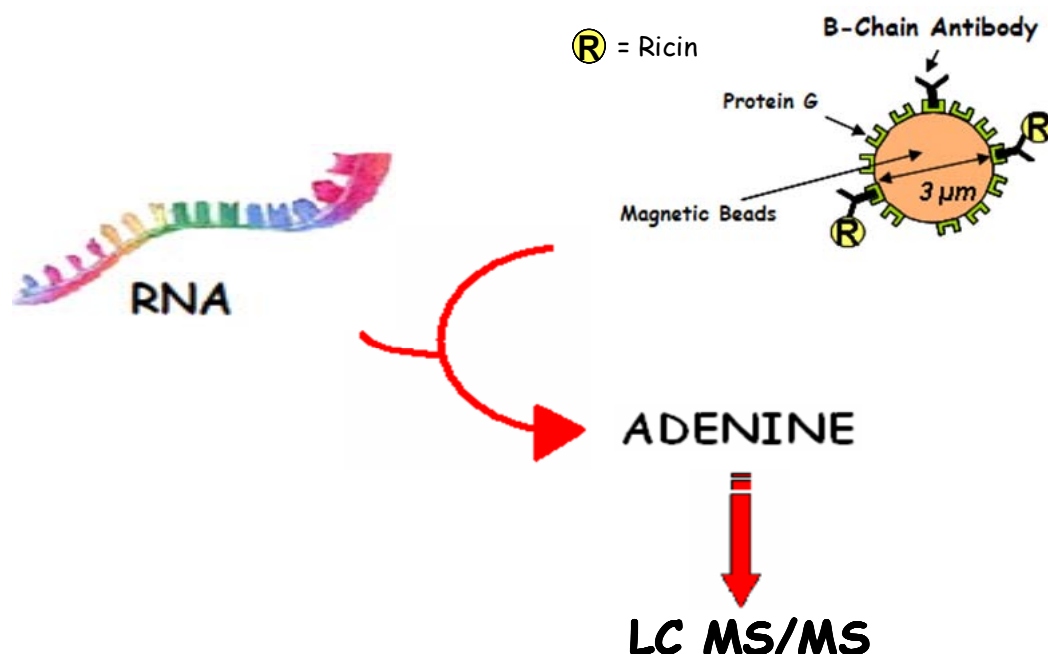

**Figure 1.** Detection of functional ricin by combination of immunocapture and LC-MS/MS.

**Figure 1.** Détection de la ricine fonctionnelle par immunocapture et CL-SM/SM.

## Conclusion

The feasibility of ricin detection by LC-MS/MS analysis coupled with immunocapture by anti-B chain antibodies has been demonstrated using food samples, such as milk, tap water, and mineral water. On analysis of milk samples spiked with ricin, no inhibition by endogenous lactose of antigen-antibody recognition during immunocapture was noted, suggesting that this method could be used to detect ricin in other matrices with the same efficiency.

## References

- Becher F, Duriez E, Volland H, Tabet JC, Ezan E (2007) Detection of functional ricin by immunoaffinity and liquid chromatography-tandem mass spectrometry. *Anal Chem* **79**: 659-665
- Boyer AE, Quinn CP, Woolfitt AR, Pirkle JL, McWilliams LG, Stamey KL, Bagarozzi DA, Hart JC Jr, Barr JR (2007) Detection and quantification of anthrax lethal factor in serum by mass spectrometry. *Anal Chem* **79**: 8463-8470
- Bradberry SM, Dickers KJ, Rice P, Griffiths GD, Vale JA (2003) Ricin poisoning. *Toxicol Rev* **22**: 65-70
- Burnett JC, Henchal EA, Schmaljohn AL, Bavari S (2005) The evolving field of biodefense: therapeutic developments and diagnostics. *Nature Rev Drug Discov* **4**: 281-297
- Crompton R, Gall D (1980) Georgi Markov-death in a pellet. *Med Leg J* **48**: 51-62.
- Demirev P A, Fenselau C (2008) Mass spectrometry in biodefense. *J Mass Spectrom* **43**: 1441-1457
- Duriez E, Fenaille F, Tabet JC, Lamourette P, Hilaire D, Becher F, Ezan E. (2009) Detection of ricin in complex samples by immunocapture and matrix-assisted laser desorption/ionization time-of-flight mass spectrometry. *J Proteome Res* **7**: 4154-4163
- Duriez E, Goossens PL, Becher F, Ezan E (2009) Femtomolar detection of the anthrax edema factor in human and animal plasma. *Anal Chem* **81**: 5935-5941.
- Eswaramoorthy S, Kumaran D, Keller J, Swaminathan S (2004) Role of metals in the biological activity of *Clostridium botulinum* neurotoxins. *Biochemistry* **43**: 2209-2216.
- Kalb SR, Goodnough MC, Malizio CJ, Pirkle JL, Barr JR (2005) Detection of botulinum neurotoxin A in a spiked milk sample with subtype identification through toxin proteomics. *Anal Chem* **77**: 6140-6146
- Kalb SR, Barr JR (2009) Mass spectrometric detection of ricin and its activity in food and clinical samples. *Anal Chem* **81**: 2037-2042
- Keener WK, Rivera VR, Young CC, Poli MA (2006) An activity-dependent assay for ricin and related RNA N-glycosidases based on electrochemiluminescence. *Anal Biochem* **357**: 200-207
- Lord JM, Roberts LM, Robertus JD (2006) Ricin: structure, mode of action, and some current applications. *FASEB J* **8**: 201-208
- Mabry R, Brasky K, Geiger R, Carrion R Jr, Hubbard GB, Leppla S, Patterson JL, Georgiou G, Iverson BL (2006) Detection of anthrax toxin in the serum of animals infected with *Bacillus anthracis* by using engineered immunoassays. *Clin Vaccine Immunol* **13**: 671-677



- Molin FD, Fasanella A, Simonato M, Garofolo G, Montecucco C, Tonello F (2008) Ratio of lethal and edema factors in rabbit systemic anthrax. *Toxicon* **52**: 824-828
- Montecucco C, Schiavo G (1995) Structure and function of tetanus and botulinum neurotoxins. *Q Rev Biophys* **28**: 423-472
- Olsnes S, Kozlov JV (2001) Ricin. *Toxicon* **39**: 1723-1728
- Sharma SK, Whiting RC (2005) Methods for detection of *Clostridium botulinum* toxin in foods. *J Food Prot* **68**: 1256-1263
- Sirisanthana T, Nelson KE, Ezzell JW, Abshire TG (1988) Serological studies of patients with cutaneous and oral-oropharyngeal anthrax from northern Thailand. *Am J Trop Med Hyg* **39**: 575-581
- Turk BE, Wong TY, Schwarzenbacher R, Jarrell ET, Leppla SH, Collier RJ, Liddington RC, Cantley LC (2004) The structural basis for substrate and inhibitor selectivity of the anthrax lethal factor. *Nat Struct Mol Biol* **11**: 60-66
- Vitale G, Bernardi L, Napolitani G, Mock M, Montecucco C (2000) Susceptibility of mitogen-activated protein kinase kinase family members to proteolysis by anthrax lethal factor. *Biochem J* **352**(Pt 3): 739-745
- Yan-Kenigsberg J, Bertocchi A, Garber EA (2008) Rapid detection of ricin in cosmetics and elimination of artifacts associated with wheat lectin. *J Immunol Methods* **336**: 251-254
-

## **Development of surface plasmon resonance-based assays for botulinum neurotoxin activity**

Christian LEVEQUE<sup>1,2</sup>, Géraldine FERRACCI<sup>2</sup>, Michael SEAGAR<sup>1\*</sup>

<sup>1</sup> Institut National de la Santé et de la Recherche Médicale, Unité 641, Marseille F-13916 France ; <sup>2</sup> Centre d'Analyse Protéomique de Marseille (CAPM), Université de la Méditerranée (IFR 11), Faculté de Médecine secteur nord, Bd P. Dramard, Marseille F-13916, France

\* Corresponding author ; Tel : +33 (0)4 9169 8929 ; Fax : +33 (0)4 9109 0506 ;  
E-mail : michael.seagar@univmed.fr

---

### **Abstract**

*Botulinum neurotoxins are potent poisons but also precious therapeutic agents for the treatment of a wide range of affections. Toxin action involves proteolytic cleavage of SNARE proteins that ensure synaptic vesicle fusion and acetylcholine release from motoneuron terminals. We have recently established methods to measure cleavage of endogenous VAMP2 and SNAP-25 using a panel of monoclonal antibodies against SNARE epitopes and surface plasmon resonance (Biacore). This approach has led to developing a rapid and sensitive assay for the activity of botulinum neurotoxins with potential applications in screening for inhibitors or in monitoring the quality of pharmaceutical preparations.*

### **Développement de dosages de l'activité des neurotoxines botuliques par résonance plasmonique de surface**

*Les neurotoxines botuliques sont des poisons très puissants mais aussi de précieux outils thérapeutiques présentant un large éventail d'applications. Ces toxines clivent spécifiquement les protéines SNARE impliquées dans la fusion des vésicules synaptiques et la libération d'acétylcholine au niveau des terminaisons des motoneurones. Nous avons récemment mis au point des méthodes permettant de mesurer le clivage de la VAMP2 et de la SNAP-25 endogènes en utilisant des anticorps anti-SNARE et la résonance plasmonique de surface (SPR). Cette méthode permet un dosage rapide et sensible de l'activité des neurotoxines botuliques avec des applications potentielles pour le criblage d'inhibiteurs ou le contrôle qualité de préparations pharmaceutiques.*

**Keywords :** *Botulinum neurotoxin, SNAP-25, SNARE assay, surface plasmon resonance, VAMP2.*

---

## **Introduction**

Botulinum neurotoxins (BoNTs), are microbial toxins, produced by bacteria of the genus *Clostridia*. BoNTs are synthesized as a complex that contains a 150 kDa neurotoxin protein and several associated proteins. There are seven immunologically distinct BoNT serotypes (A to G) each consisting of two polypeptide chains, covalently attached by a disulfide bond. The heavy chain vectors the neurotoxin to motoneuron nerve terminals *via* recognition of specific receptors and ensures intracellular penetration of the light chain. The light chain is a zinc metalloprotease which interferes with neuromuscular transmission by specifically cleaving SNARE proteins, which are essential for acetylcholine release. BoNT/C cleaves both syntaxin and SNAP-25, expressed in the plasma membrane, BoNT/A and E cleave SNAP-25, whereas BoNT/B, D, F and G clip VAMP2 (Vesicle Associated Membrane Protein 2 or synaptobrevin), a synaptic vesicle (SV) membrane protein (Humeau *et al.*, 2000).

Numerous *in vitro* methods, using synthetic peptides as substrates, have been used to measure the enzymatic activity of BoNTs (Capeck and Dickerson, 2010). However there is also a need to develop simple methods to detect cleavage of native endogenous SNARE proteins by BoNTs. As BoNTs abrogate Ca<sup>2+</sup>-dependent exocytosis in a variety of neuronal preparations, these neurotoxins are widely used as tools for basic research in model systems such as nerve-muscle preparations, brain slices, subcellular fractions (*e.g.* synaptosomes) or neural cultures. Monitoring SNARE cleavage in cell-based assays is also of interest for projects to screen for BoNT inhibitors. Molecules that block BoNT action could target properties of BoNTs other than enzymatic activity, like receptor binding and translocation into the cytoplasm, properties that can only be evaluated in intact cell assay systems. Neuronal cell culture assays can provide information on the activity of both the heavy and light chains including the capacity of the heavy chain to confer binding and internalization and the metalloprotease activity of the light chain on endogenous SNAREs. In addition, cell culture models are useful to determine the potency of pharmaceutical forms of BoNT/A and B that have been approved for clinical

and cosmetic use (Hakami *et al.*, 2010). Importantly, efficient and reliable cell-based assays could potentially replace the mouse assay currently in routine use for quality control in industrial production (Lindstrom and Korkeala, 2006).

Western blot analysis of cell lysates using anti-SNARE antibodies is the most commonly used method to assess the enzymatic activity of BoNTs in biological models. However Western blotting is time-consuming and quantification for routine assays is laborious. FRET signals generated by transfected SNAREs constitute an alternative method for the detection of BoNT/A and B activities (Dong *et al.*, 2004). However this approach using clonal neuroendocrine cell lines requires high BoNT concentrations, as these cells are less sensitive to toxin action than neurons.

Surface Plasmon Resonance (SPR) has recently emerged as an alternative method to quantify cleavage of native VAMP2 and SNAP-25 by BoNTs (Ferracci *et al.*, 2004 and 2005, Marconi *et al.*, 2008). SPR spectroscopy allows real time measurement of interactions between ligands such as antibodies immobilized on different flow channels of a sensor-chip and analytes injected in solution into the flow buffer. Labelling of molecules is not required and automatic analysis of small sample volumes can be carried out. The originality of the approach developed in our lab relies on the direct analysis of membrane proteins without prior extraction by solubilisation.

### SPR detection of cleavage of native SNAREs by BoNTs

Our initial strategy to detect BoNT activity on native SNAREs involved measuring the binding of anti-SNARE antibodies to neuronal membranes expressing SNARE proteins. Membranes were pretreated with BoNTs and then captured on an SPR sensor chip using antibodies directed against a neutral component of the vesicle (i.e. a vesicle membrane protein that is not affected by BoNT action). BoNTs were found to cause a robust decrease in binding of anti-SNARE antibodies directed against epitopes distal to membrane anchors due to proteolytic clipping. In this way, the use of antibodies against the N-terminal domain of VAMP2 allows measurement of VAMP2 cleavage in SVs by BoNT/B or F (Ferracci *et al.*, 2004) and a similar strategy can be extended to all BoNTs. This assay is quantitative but like ELISA it requires several steps including independent immobilization of vesicles in distinct flow channels (treated versus non-treated preparations), injection of anti-SNARE antibodies and regeneration after each detection. The major drawback of this approach is thus the time required to complete the assay.

A simpler SPR method is now currently performed in our lab to assay BoNT activity (Ferracci *et al.*, 2005). The experimental rationale is based on the use of vesicles expressing native SNAREs as the analyte which is titrated by injection over immobilized antibodies directed against the appropriate SNARE substrates. These vesicles are either synaptic vesicles, or small plasma membrane vesicles produced by sonication. These fairly crude membrane fractions can be rapidly prepared from brain tissue or from cultured neurons that have been treated with BoNT. The method can readily detect low picomolar concentrations of SNAREs. The high sensitivity is inherent to the small flow cell volume which allows antibody binding at concentrations considerably higher than  $10 \times K_D$  and the high molecular mass of the analytes, which amplifies SPR signals. Antibodies may be directed against substrate epitopes that are clipped off by toxin action. In this case BoNT activity is assayed as a reduction in membrane capture as shown in *Figure 1*. Other antibodies bind to epitopes that are absent in the native substrate, but are specifically produced by the proteolytic action of BoNTs (e.g. a new carboxyl terminus). Here BoNTs are assayed by the increase in membrane capture (Marconi *et al.*, 2008). The injection of neuronal lysates over several antibodies, each in a distinct channel, establishes the specificity of the assay as shown in *Figure 1*.

The occupancy of mAbs by native membrane-anchored SNAREs reflects the analyte concentration in the sample, yielding quantitative data. We applied this method to assay BoNT/A, B, F and E activity using several cellular models and it could be generalized to all BoNTs. The sensitivity of SPR, combined with parallel measurements on a single sample of both non-specific binding and internal reference antigens for normalization, facilitate quantification of BoNTs activity on cultured cells correcting well-to-well variability in cell seeding and extraction. *Figure 2* illustrates a dose-response curve for BoNT/B in cerebellar granule neurons. An  $EC_{50}$  value of  $13 \pm 2$  pM was obtained in agreement with the data from Western blotting (Foran *et al.*, 1993).

The SPR method has also been used to assay endo-peptidase activity by incubating BoNTs directly with fractions containing synaptic or plasma membrane-derived vesicles. The sensitivity of the assay reached a low femtomolar concentration for BoNT/B whereas a picomolar threshold was obtained for BoNT/A. The sensitivity achieved for BoNT/B is comparable to the most sensitive assay described to date (Boyer, 2005). The sensitivity of SPR assays is lower for BoNT/A, compared to other reports on peptide-based assays (Boyer, 2005), probably due to restricted accessibility of the C-terminal domain of native SNAP-25 to BoNT/A.

### Assay performance

SPR was compared to ELISA and cytometry, both well-established methods for membrane proteins to define the most effective read-out technique for BoNT/B assays.  $EC_{50}$ s values for BoNT/B measured by SPR were practically identical to those obtained by ELISA and flow cytometry (Marconi *et al.*, 2008). However SPR confers several advantages in terms of speed and reagent economy over conventional methods. Sensor surface preparation is complete within 45 min, with all preparation steps monitored. Even if the sample read-out time is longer with SPR (about 5 min), overall analysis-time is reduced. A dose-response curve can be established in 1.5 hours versus at least 4 hours with the other methods. Antibody requirements are about 200-fold lower with

SPR than ELISA or flow cytometry (1 µg IgG is needed to functionalize a flow cell, which can be used for more than 100 injections) and SPR does not require labelling. Sample consumption is also reduced with SPR which uses smaller volumes. Amounts required are further reduced by the fact that different antigens can be measured on the same sample in parallel flow cells, although parallel read-outs are also possible with cytometry using probes labelled with different fluorophores.

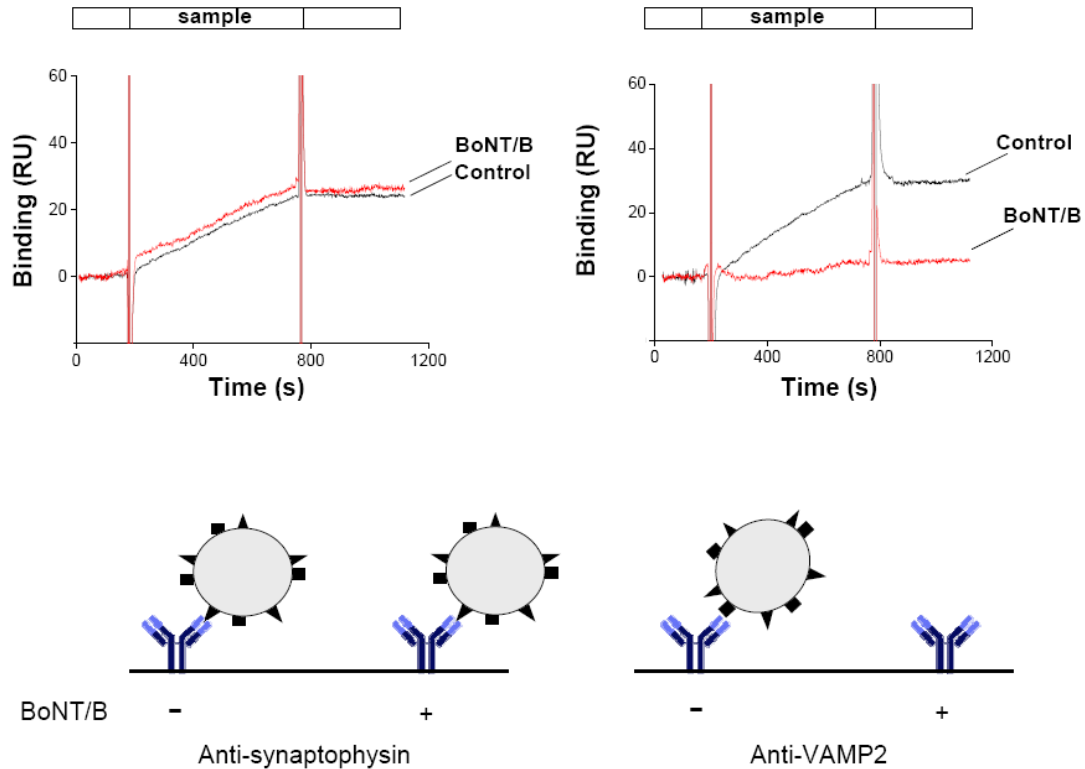

**Figure 1. Principle of the assay for the detection of BoNT/B activity by SPR.** In control conditions the capture of synaptic vesicle antigens by immobilized antibodies against synaptophysin (triangles) or VAMP2 (squares) produces an increase in SPR signal. Binding to anti-VAMP2 antibodies is lost in the presence of BoNT/B.

**Figure 1. Principe du test SPR pour le dosage de l'activité de la neurotoxine botulique B.** Dans des conditions contrôles, la capture des vésicules synaptiques par un anticorps dirigé contre la-synaptophysine (triangles) ou-VAMP2 (carrés) produit un gain de signal. La présence de BoNT/B dans l'échantillon se traduit par une perte du signal seulement sur l'anticorps anti-VAMP2.

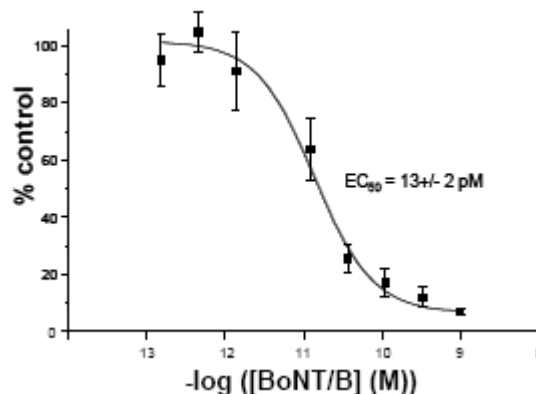

**Figure 2. Measurement of the activity of BoNT/B holotoxin in cultured neurons.** After incubation of cultured cerebellar granule neurons with BoNT/B, cells were lysed in a hypotonic buffer, centrifuged briefly at 10 000xg and the supernatant is injected over a sensor chip carrying coupled anti-VAMP2 antibodies.

**Figure 2. Mesure de l'activité de la neurotoxine botulique B dans des neurones en cultures.** Après incubation des neurones (cellules en grain du cervelet) avec la BoNT/B, les cellules sont lysées dans un tampon hypotonique, centrifugées brièvement à 10 000g et le surnageant est injecté sur une biopuce fonctionnalisée avec un anticorps anti-VAMP2.

## Conclusion

Using SPR as a detection tool for the measurement of SNARE cleavage opens new avenues for rapid detection and quantification of BoNT activity using endogenous substrates. This automated method enables the rapid detection of native SNARE protein in lysates derived from only minute amounts of neurons that are not readily accessible to traditional biochemical methods. The SPR biosensor method was sensitive enough to monitor BoNT/A and B activity in cells cultured in a 96-well format providing an alternative to live animals for toxicological assays. The use of a multiplexed SPR apparatus with several independent injection syringes can increase the readout. In the assays we have described here the loss of the same region of a SNARE could be produced by two different BoNT serotypes (*e.g.* both BoNT/B and BoNT/F clip off the N-terminal domain of VAMP 2). A future direction to improve specificity would be to use mAbs that only recognize the cleaved SNARE products (*e.g.* bind to amino- or carboxy-terminal residues produced by proteolysis at a specific peptide bond). Our lab is currently developing mAbs with these properties.

**Acknowledgements.** This research was supported by a grant from the Direction Générale de l'Armement.

## References

- Boyer AE, Mour H, Woolfitt AR, Kalb SR, McWilliams LG, Pavlopoulos A, Schmidt JG, Ashley DL, Barr JR (2005) From the mouse to the mass spectrometer: detection and differentiation of the endoprotease activities of botulinum neurotoxins A-G by mass spectrometry. *Anal Chem* **77**: 3916-3924
- Capeck P, Dickerson TJ (2010) Sensing the deadliest toxin: technologies for botulinum neurotoxin detection. *Toxins* **2**: 24-53
- Dong M, Tepp WH, Johnson EA, Chapman ER (2004) Using fluorescent sensors to detect botulinum neurotoxin activity *in vitro* and in living cells. *Proc Natl Acad Sci USA* **101**: 14701-14706
- Ferracci G, Miquelès R, Kozaki S, Seagar M, Lévêque C (2005) Synaptic vesicle chips to assay botulinum neurotoxins. *Biochem J* **391**: 659-666
- Ferracci G, Seagar M, Joel C, Miquelès R, Lévêque C (2004) Real time analysis of intact organelles using surface plasmon resonance. *Anal Biochem* **334**: 367-375
- Foran PG, Mohammed N, Lisk GO, Nagwaney S, Lawrence GW, Johnson E, Smith L, Aoki KR, Dolly JO (2003) Evaluation of the therapeutic usefulness of botulinum neurotoxin B, C1, E, and F compared with the long lasting type A. Basis for distinct durations of inhibition of exocytosis in central neurons. *J Biol Chem* **278**: 1363-1371
- Hakami RM, Ruthel G, Stahl AM, Bavari S (2010) Gaining ground: assays for therapeutics against botulinum neurotoxin. *Trends Microbiol* **18**: 164-172
- Humeau Y, Doussau F, Grant NJ, Poulain B (2000) How botulinum and tetanus neurotoxins block neurotransmitter release? *Biochimie* **82**: 427-446
- Lindstrom M, Korkeala H (2006) Laboratory diagnostics of botulism. *Clin Microbiol Rev* **19**: 298-314
- Marconi S, Ferracci G, Berthomieu M, Kozaki S, Miquelès R, Boucraut J, Seagar M, Lévêque C (2008) A protein chip membrane-capture assay for botulinum neurotoxin activity. *Toxicol Appl Pharmacol* **233**: 439-446
-

## **Tests rapides, utilisables sur le terrain, pour la détection de toxines**

Hervé VOLLAND<sup>1\*</sup>, Patricia LAMOURETTE<sup>1</sup>, Michel-Robert POPOFF<sup>2</sup>, Christelle MAZUET<sup>2</sup>, Marie-Claire NEVERS<sup>1</sup>, Julie DANO<sup>1</sup>, Cécile FERAUDET-TARISSE<sup>1</sup>, Bernard LAGOUTTE<sup>3</sup>, Christophe CREMINON<sup>1</sup>

<sup>1</sup> CEA, iBiTecS, Service de Pharmacologie et d'Immunoanalyse, F-91191 Gif sur Yvette cedex, France ; <sup>2</sup> Unité des Bactéries anaérobies et Toxines, Institut Pasteur, 28 rue du Docteur Roux, F-75015 Paris, France ; <sup>3</sup> CEA, iBiTecS, CNRS URA 2096, F- 91191 Gif sur Yvette cedex, France

\* Auteur correspondant ; Tél : +33 (0)1 6908 1314 ; Fax : +33 (0) 1 6908 5907 ;  
Courriel : [herve.volland@cea.fr](mailto:herve.volland@cea.fr)

---

### **Résumé**

*La biosécurité devient une préoccupation mondiale majeure et il y a un besoin de systèmes performants pour détecter les agents biologiques aussitôt qu'ils apparaissent ou qu'ils sont dispersés. Nous avons décidé de développer des tests immunochromatographiques parce qu'ils sont rapides et simples et qu'ils peuvent être utilisés par des non-spécialistes. Après la production d'anticorps monoclonaux dirigés contre différentes toxines, nous avons développé et validé plusieurs tests bandelettes. Ces tests sont suffisamment sensibles pour détecter sur le terrain des concentrations mortelles de toxines.*

### **Rapid assays for field detection of toxins**

*The biosecurity becomes a worldwide major concern and there is need for powerful system to detect biological agent as soon as it appears or is dispersed. We have decided to develop lateral flow immunoassays because there are rapid, simple and they can be used by non-specialist. After the production of monoclonal antibodies directed against different toxins, we have developed and validated several strip tests. These tests are sensitive enough to detect on the field, life-threatening toxin concentrations.*

**Keywords** : Biosecurity, detection, immunoassays, monoclonal antibodies, rapid tests.

---

## **Introduction**

Certains agents biologiques constituent une menace très sérieuse pour la santé publique tant du fait d'événements non intentionnels (pollutions, contamination,...) que d'utilisations malveillantes potentielles. Ces agents peuvent être des virus, des bactéries, des champignons, des parasites ou des toxines. En fonction de la nature de l'agent, les mesures d'alertes et de prévention varient. En effet, les virus et les microorganismes ont souvent besoin d'un temps d'incubation avant l'expression des symptômes ce qui peut rendre difficile la distinction entre une attaque bioterroriste et une épidémie. Au contraire, les toxines agissent rapidement sans temps d'incubation. A cause du danger résultant de ces agents biologiques pour la santé publique qu'ils soient utilisés intentionnellement ou non, le développement de méthodes de détection sensibles et rapides pour détecter les moindres traces de ces agents dans l'environnement, les matrices alimentaires, l'eau, les milieux biologiques..., représente une nécessité. Durant les 20 dernières années, des technologies et des systèmes ont été développés pour s'adapter au défi que représente la détection et l'identification de ces agents dans un intervalle de temps allant de quelques minutes à plusieurs heures. Les dosages immunologiques qui sont les techniques analytiques les plus utilisées dans les laboratoires médicaux (Peruski and Peruski, Jr., 2003) semblent tout à fait adaptés pour répondre à ces exigences. Plus récemment, les efforts se sont concentrés sur la mise au point de dosages immunologiques utilisables sur le terrain par des non spécialistes pour une surveillance de l'environnement ou pour une utilisation par le patient. Parmi ces dosages, les plus utilisés sont les tests immunochromatographiques ou tests "bandelette". Ces tests évitent non seulement le transport des échantillons jusqu'à un laboratoire mais permettent également l'obtention très rapide d'un résultat. Cela peut permettre la mise en place de moyens de lutte, de protection et/ou thérapeutiques plus efficaces.

## **Principe des tests "bandelette" pour la détection des toxines**

Une bandelette se compose de 3 zones (*Figure 1*):

- 1) A sa base, un tampon de dépôt recevant l'échantillon;
- 2) Une membrane de nitrocellulose sur laquelle migrera l'échantillon;
- 3) A l'extrémité de la bandelette, un tampon absorbant favorisant la migration.

Sur la membrane de nitrocellulose sont déposées deux lignes d'anticorps: la ligne de test, constituée d'anticorps anti-toxine et la ligne de contrôle, constituée d'anticorps anti-anticorps traceur. Enfin, un troisième anticorps anti-toxine (anticorps traceur) couplé à une molécule de détection (or-colloïdal pour un signal colorimétrique (Laitinen and Vuento, 1996; Molinelli *et al.*, 2008), fluorophore pour une détection en fluorescence (Ahn *et al.*, 2003);...) est présent dans le tampon de dépôt sous forme déshydratée ou peut-être rajouté dans l'échantillon à analyser. Il faut noter que le format décrit précédemment (format immunométrique ou "sandwich") permet la détection de molécules de taille supérieure à environ 2000 Daltons. Pour la détection de molécule de taille inférieure un autre format (compétitif) est utilisé. Dans ce format la ligne test est constituée de la toxine ou d'un analogue de la toxine couplé à une protéine.

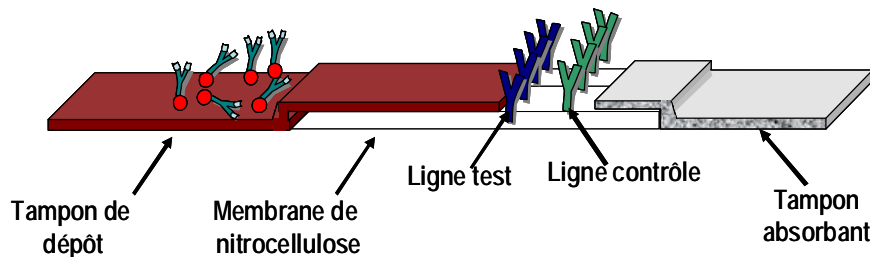

Figure 1. Différents constituants d'une bandelette.

Figure 1. Different components of a strip.

Dans le format immunométrique, si la toxine est présente dans l'échantillon, le complexe toxine/anticorps traceur, formé avant le dépôt ou au moment de la resolubilisation du traceur, va être capturé par le deuxième anticorps au niveau de la ligne test au cours de la migration. L'excès de traceur n'ayant pas réagi avec la toxine sera lui capturé au niveau de la ligne contrôle par un anticorps anti-anticorps traceur. Si la toxine est absente de l'échantillon, l'anticorps traceur ne sera pas immobilisé au niveau de la ligne test. Dans ce format, le test est donc positif si un signal apparaît au niveau des deux lignes et est négatif si un signal apparaît seulement au niveau de la ligne contrôle (Figure 2A). Comme indiqué précédemment, le signal obtenu dans ce format est proportionnel à la quantité d'analyte présent dans l'échantillon.

Dans le format compétitif, si la toxine est présente dans l'échantillon, un complexe toxine/anticorps traceur va se former avant le dépôt ou au moment de la resolubilisation du traceur. Tout ou partie des sites paratopiques de ces anticorps sera donc occupé et une part plus ou moins importante du traceur ne pourra donc pas réagir avec la toxine (ou analogue) immobilisée au niveau de la ligne test. Si la toxine est absente de l'échantillon, l'anticorps traceur pourra réagir avec l'ensemble des molécules d'intérêt immobilisées au niveau de la ligne test. Le signal obtenu au niveau de cette ligne sera donc maximal. Dans tous les cas, une partie du traceur réagira avec l'anticorps anti-anticorps traceur situé au niveau de la ligne contrôle (Figure 2B). Dans ce format, le test sera donc positif lorsqu'un signal n'apparaît qu'au niveau de la ligne contrôle et sera négatif lorsqu'un signal apparaît au niveau des deux lignes. Une quantification pourra être envisagée dans l'intervalle de concentrations pour lequel le signal de la ligne test est inversement proportionnel à la concentration de la toxine.

Si à la fin du test aucun signal n'apparaît, même au niveau de la ligne contrôle, cela signifie que le test n'a pas été effectué dans les bonnes conditions ou que l'échantillon n'est pas analysable en l'état.

## Développement des tests bandelettes

### Choix des toxines et mise au point

Pour ce projet, nous avons choisi des toxines de différentes natures et présentes dans différents milieux. Ces toxines sont:

- L'entérotoxine B de *Staphylococcus aureus* qui est une toxine protéique pouvant être responsable d'intoxication alimentaire après consommation de produits laitiers (Le *et al.*, 2003).
- Les toxines botuliques A, B et E qui sont des toxines protéiques responsables d'intoxication alimentaires (Liu *et al.*, 2003) et potentiellement utilisables comme arme bioterroriste.
- La ricine qui est une toxine protéique d'origine végétale potentiellement utilisable comme arme bioterroriste (Audi *et al.*, 2005).
- Les microcystines qui sont des toxines peptidiques (peptide cyclique) présentes dans les eaux de surface (rivières, lacs,...) pouvant provoquer des intoxications par consommation d'eau contaminée par certaines cyanobactéries (Teixeira *et al.*, 1993).

Pour le développement des tests "bandelette" nous avons produit des anticorps monoclonaux dirigés contre l'ensemble de ces toxines: 16 anticorps monoclonaux (mAbs) anti-entérotoxine B, 14 mAbs anti-toxine botulique A, 15 mAbs anti-toxine botulique B, 17 mAbs anti-toxine botulique E, 25 mAbs anti-ricine et 48 mAbs anti-microcystine.

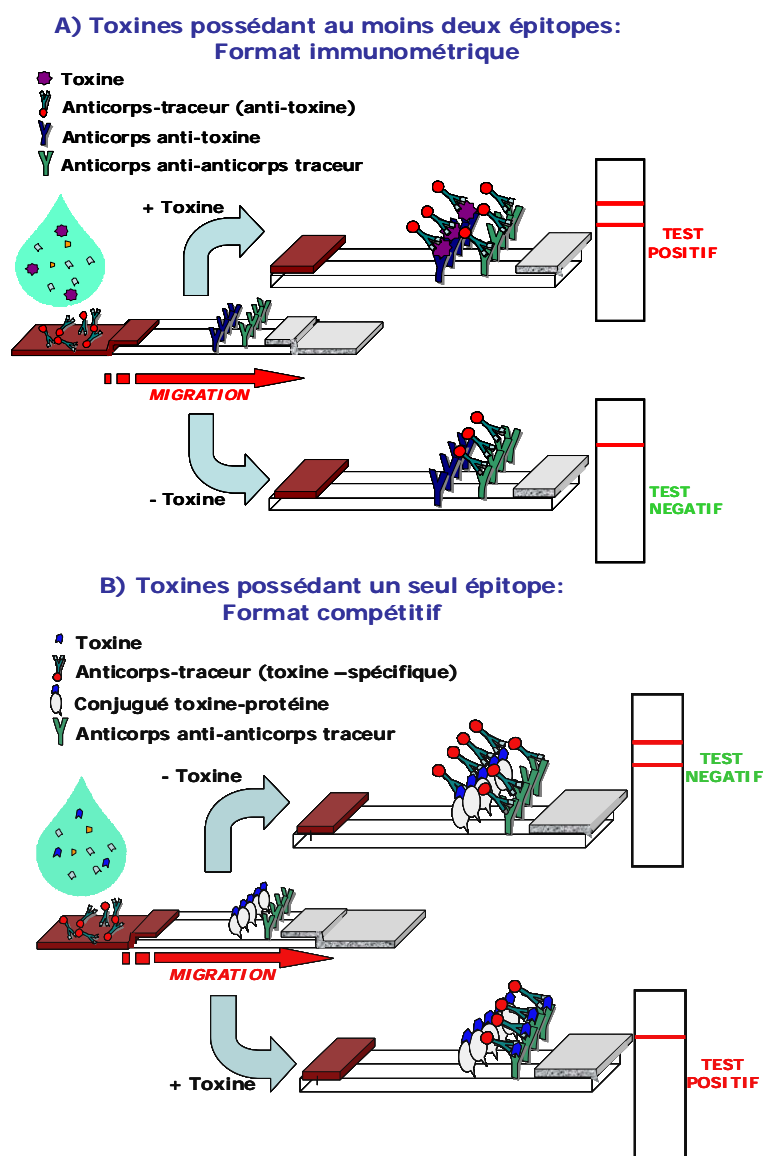

**Figure 2.** Principe des tests bandelettes.  
*Figure 2.* Principle of strip tests.

Parmi ces toxines seules les microcystines sont détectées en utilisant un format compétitif.

En utilisant nos anticorps monoclonaux et un marquage à l'or colloïdal nous avons mis au point des tests bandelettes spécifiques et sensibles (*Tableau 1*) dont la durée n'excède pas 30 minutes.

**Tableau 1.** Limites de détection obtenues avec les tests bandelettes pour les différentes toxines.  
*Table 1.* Limits of detection obtained with strip tests for different toxins.

Toxine	Limite de détection (ng/ml)	Limite de détection (fmol/ml)
Entérotoxine B	1	373
Toxine botulique A	2.5	166
Toxine botulique B	2.5	166
Toxine botulique E	5	332
Ricine	1	373
Microcystine	1	1000



Les limites de détection obtenues sont très satisfaisantes par comparaison à celles communiquées par différents fabricants de tests "bandelette" (Tableau 2).

**Tableau 2.** Limite de détection obtenues avec des test bandelettes commercialisées pour les différentes toxines.  
**Table 2.** Limit of detection obtained with marketed strip tests for different toxins.

Toxines	Fabricant			
	Tetracore	Response biomedical Corp.	ADVNT Biotechnologies	Dräger
Entérotoxine B			10 ng/ml <sup>3</sup>	10 ng/ml <sup>4</sup>
Tox. Bot. A	10 ng/ml <sup>1</sup>	500 ng/ml <sup>2</sup>	33 ng/ml <sup>3</sup>	50 ng/ml <sup>4</sup>
Tox. Bot. B	10 ng/ml <sup>1</sup>	500 ng/ml <sup>2</sup>	500 ng/ml <sup>3</sup>	50 ng/ml <sup>4</sup>
Ricine	35 ng/ml <sup>1</sup>	1 µg/ml <sup>2</sup>	5 ng/ml <sup>3</sup>	200 ng/ml <sup>4</sup>

<sup>1</sup> [www.epa.gov/nhsrc/pubs/vrBioThreat092104.pdf](http://www.epa.gov/nhsrc/pubs/vrBioThreat092104.pdf)

<sup>2</sup> [www.epa.gov/nhsrc/pubs/vrRAMP092004.pdf](http://www.epa.gov/nhsrc/pubs/vrRAMP092004.pdf)

<sup>3</sup> [www.advnt.org/products/biowarfare/techlibrary/SpecSheet\\_PS\\_and\\_BADD.pdf](http://www.advnt.org/products/biowarfare/techlibrary/SpecSheet_PS_and_BADD.pdf)

<sup>4</sup> [www.draeger.cn/ST/internet/pdf/Master/En/.../PI\\_BioAgentZest\\_EN.pdf](http://www.draeger.cn/ST/internet/pdf/Master/En/.../PI_BioAgentZest_EN.pdf)

Les deux exemples de gammes de dilution de toxines détectées à l'aide de nos tests (Figure 3) confirme que le signal est proportionnel à la concentration de toxines pour le format immunométrique et inversement proportionnel pour le format compétitif (Microcystine).

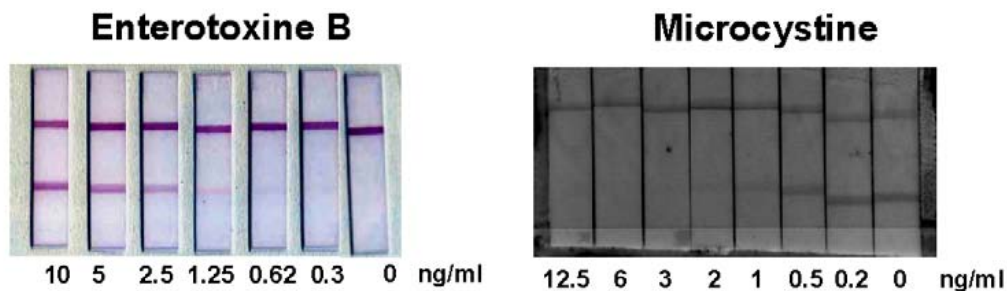

**Figure 3.** Gammes de dilution de toxines détectées par les tests bandelette.

**Figure 3.** Serial dilutions of toxins detected by strip tests.

### Validation des tests

Après la mise au point des tests, il est nécessaire de les valider en les utilisant avec des toxines diluées dans les milieux susceptibles de les contenir naturellement ou lors d'actes malveillants. Nous avons, par exemple, détecté l'entérotoxine B dans différentes matrices alimentaires: jus de pomme, eau du robinet, eau de surface, lait demi-écrémé, fromage et jambon. Cette étude a montré que nos tests étaient fonctionnels dans ces matrices pures ou diluées au 1/5<sup>ième</sup>.

Pour la détection des microcystines une contrainte supplémentaire a été rencontrée. En effet si ces toxines se retrouvent dans l'eau elles sont essentiellement intracellulaires (>90%) (Rivasseau *et al.*, 1998). Pour obtenir une détection efficace de ces toxines dans leur milieu naturel il a été nécessaire de développer une nouvelle méthode d'extraction. En effet les méthodes couramment employées utilisent des étapes de congélation-décongélation, de sonication ou de lyophilisation. Toutes ces étapes nécessitent des appareillages qui n'autorisent pas une extraction sur le terrain.

La méthode que nous avons développée nécessite une seringue, un filtre, un tube et deux solvants. La durée totale de la procédure n'excède pas 10 minutes. Elle est donc parfaitement compatible avec une utilisation terrain. D'autre part cette méthode s'est avérée aussi efficace pour extraire les microcystines que les méthodes classiques pour l'ensemble des échantillons que nous avons testés.

### Conclusion

L'une des étapes critiques lors du développement de tests immunochromatographiques est l'obtention d'anticorps monoclonaux dont l'affinité permet d'atteindre des limites de détection compatibles avec les concentrations attendues sur le terrain. D'autre part si la détection des toxines nécessite une étape de traitement de l'échantillon, il est nécessaire de mettre au point un procédé rapide et simple compatible avec une utilisation sur le terrain afin de conserver l'un des avantages des tests bandelette. Pour augmenter la sensibilité de ces tests nous travaillons actuellement sur le développement de nouveaux traceurs fluorescents et sur la mise au point de lecteurs de bandelettes portatifs performants.

**Remerciements.** Les auteurs remercient Maria-liisa Tunkerlott, Géraldine Carpentier et Simon Jammes pour leur aide précieuse tout au long du développement des tests "bandelette".

### Références

- Ahn JS, Choi S, Jang SH, Chang HJ, Kim JH, Nahm KB, Oh SW, Choi EY (2003) Development of a point-of-care assay system for high-sensitivity C-reactive protein in whole blood. *Clin Chim Acta* **332**: 51-59
- Audi J, Belson M, Patel M, Schier J, Osterloh J (2005) Ricin poisoning - A comprehensive review. *JAMA* **294**: 2342-2351
- Laitinen MP, Vuento M (1996) Immunochromatographic assay for quantitation of milk progesterone. *Acta Chem Scand* **50**: 141-145
- Le LY, Baron F, Gautier M (2003) *Staphylococcus aureus* and food poisoning. *Genet Mol Res* **2**: 63-76
- Liu W, Montana V, Chapman ER, Mohideen U, Parpura V (2003) Botulinum toxin type B micromechanosensor. *Proc Natl Acad Sci USA* **100**: 13621-13625
- Molinelli A, Grossalber K, Fuehrer M, Baumgartner S, Sulyok M, Krska R (2008) Development of qualitative and semiquantitative immunoassay-based rapid strip tests for the detection of T-2 toxin in wheat and oat. *J Agric Food Chem* **56**: 2589-2594
- Peruski AH, Peruski LF Jr (2003) Immunological methods for detection and identification of infectious disease and biological warfare agents. *Clin Diagn Lab Immunol* **10**: 506-513
- Rivasseau C, Martins S, Hennion MC (1998) Determination of some physicochemical parameters of microcystins (cyanobacterial toxins) and trace level analysis in environmental samples using liquid chromatography. *J Chromatogr A* **799**: 155-169
- Teixeira MG, Costa MC, de Carvalho VL, Pereira MS, Hage E (1993) Gastroenteritis epidemic in the area of the Itaparica Dam, Bahia, Brazil. *Bull Pan Am Health Organ* **27**: 244-253
-



## **Use of nano-liquid chromatography and mass spectrometry to identify a new *Cerastes cerastes* venom phospholipase A2**

Fatah CHERIFI<sup>1,2</sup>, Jean-Claude ROUSSELLE<sup>3</sup>, Abdelkader NAMANE<sup>3</sup>,  
Fatima LARABA-DJEBARI<sup>1,2\*</sup>

<sup>1</sup> Laboratoire de Biologie Cellulaire et Moléculaire, Faculté des Sciences Biologiques, Université des Sciences et de la Technologie « Houari Boumédiène » (USTHB), El Alia BP 32, 16111 Bab Ezzouar, Alger, Algérie ;

<sup>2</sup> Laboratoire de Recherche et de Développement sur les Venins, Institut Pasteur d'Algérie, Alger, Algérie ;

<sup>3</sup> Institut Pasteur, Plate-Forme de Protéomique, CNRS URA 2185, 75724 Paris cedex 15, France

\* Corresponding author ; Tel : +213 21917427 ; Fax : +213 21917221 ; E-mail : [flaraba@hotmail.com](mailto:flaraba@hotmail.com)

---

### **Abstract**

A novel phospholipase A2 (PLA2) isolated from the venom of *Cerastes cerastes* has been proteomically analyzed by nano-liquid chromatography and mass spectrometry. After reduction, alkylation and double hydrolysis of the molecule by lysine-C endopeptidase and trypsin, LC-MALDI-MS/MS was performed. The protein was identified by querying the database using the NCBI nr protein. The LCMS/MS analysis of tryptic fragments of PLA2 showed some sequence similarities with other snake venom PLA2. This new PLA2 presents only 51% (61/120 amino acid residues) sequence homology with another PLA2 previously purified from the same venom [Genbank GI (GenInfo identifier) # 129506].

### **Utilisation de nano chromatographie liquide et de la spectrométrie de masse pour identifier une phospholipase A2 isolée du venin de *Cerastes cerastes***

Une nouvelle phospholipase A2 (PLA2) du venin de *Cerastes cerastes* a été identifiée par nano chromatographie liquide et spectrométrie de masse. Après réduction, alkylation et double digestion par l'endopeptidase lysine-C et la trypsine, une LC-MALDI-MS/MS a été réalisée sur cette molécule. La protéine a été identifiée par interrogation d'une base de données utilisant la banque NCBI nr. L'analyse LCMS/MS des fragments tryptiques de cette PLA2 a montré la présence de similitudes de séquence avec d'autres PLA2 isolées d'autres venins de serpents. Cette nouvelle PLA2 présente 51% d'homologie (61/120 résidus d'acides aminés) avec la PLA2 déjà purifiée à partir du même venin [GI (identificateur de GenInfo) de Genbank # 129506].

**Keywords** : *Cerastes cerastes*, LC-MALDI-MS/MS, mass spectrometry, nano-liquid chromatography, phospholipase A2.

---

### **Introduction**

Phospholipases A2 (PLA2) isolated from snake venoms represent more than 10% of the venom dry weight. These enzymes are catalytically calcium-dependant (Kini, 1997). The PLA2 isolated from *Viperidae* venoms consist of 125-130 amino acid residues cross-linked by seven disulfide bonds which confer the molecule stability. In addition to their hydrolytic activity, PLA2 may display many other activities, such as edematous, neurotoxic, cardiotoxic, hemolytic, convulsive, antiplatelet, antitumoral and anticoagulant. Based on their anticoagulant activity, PLA2 could be clinically useful in thrombosis diseases and in diagnosis and treatment of hemostasis disorders. Anticoagulant PLA2 exhibit this activity by their ability to inhibit platelet aggregation through factor Xa (FXa) blockade. Based on their direct involvement in the haemostatic cascade, PLA2 could also be used as tools or biomarkers in blood diseases.

The venom of *Cerastes cerastes*, the most dangerous viper in Algeria, is a mixture of bioactive molecules, some of which having been well characterized. Most of these proteins act on blood coagulation, such as PLA2 (Laraba-Djebari and Martin-Eaudaire, 1990), thrombin-like enzymes RP34 and Afaâctin (Laraba-Djebari *et al.*, 1992, 1995), anticoagulant protease fraction (Chérifi and Laraba-Djebari, 2007), aggregant serine protease (Chérifi and Laraba-Djebari, 2008). In this study, we report the proteomic analysis of the second PLA2 isolated from *C. cerastes* venom. This enzyme was identified and characterized by mass spectrometry.

### **Methods**

For MS analysis, the 4800 MALDI TOF/TOF Analyzer (Applied Biosystems/MDS SCIEX, Framingham, MA, USA)

was operated in positive reflector ionization mode ( $m/z$  range: 800 to 4000). 3000 laser shots / spot were used to ensure good S/N quality for precursor selection. Internal calibration of the MS spectra using the Glu-1 fibrino peptide B ( $[M+H]^+ = 1570.670$ ) was performed automatically. For the MS/MS experiment, the 2 kV positive CID ON method was chosen. Non-redundant ions with a  $S/N > 30$  were selected as precursors and submitted to CID fragmentation (4000 laser shots/precursor, up to 15 precursors/spot). Default calibration was automatically applied to the MS/MS spectra. MS/MS queries were carried out using a local copy of MASCOT search engine 2.1 (Matrix Science Ltd., UK) embedded into GPS-Explorer Software 3.5 (Applied Biosystems/MDS SCIEX, Framingham, MA, USA) on the NCBIInr database (downloaded October 20<sup>th</sup>, 2008. 7135729 sequences). MASCOT files of the identified proteins were reanalyzed with Scaffold software which used two independent search engines (MASCOT and X! Tandem) and a workflow including PeptideProphet (peptide filtering) and ProteinProphet (protein identification filtering). Results obtained with the two search engines were then automatically combined and only proteins with a minimum of two distinct peptides (peptide confidence index  $\geq 95$ ) and a protein confidence index  $\geq 95\%$  were taken into account.

Fractions (312) collected after off-line nano liquid chromatography of digested PLA2 were analyzed by MS/MS. Overall, 1207 MS/MS spectra were acquired. Identification of the protein was carried out by querying the database using the NCBIInr protein raw MS/MS.

## Results

Analysis LC/MS and MS/MS of tryptic fragments of purified PLA2 showed some sequence similarity with other PLA2 isolated from several venoms (Table 1). The obtained results showed that the purified PLA2 is a new molecule presenting only 51% of homology with the PLA2 previously purified from the same *C. cerastes* venom [Genbank GI (GenInfo identifier) # 129506], *i.e.* 61 over 120 amino acid residues are common to the two PLA2. The peptide sequence of the new PLA2 was obtained by alignment with sequences of other venom PLA2.

**Table 1.** Some identified proteins by LC-MALDI-MS/MS presenting sequence similarity with the novel PLA2.

**Tableau 1.** Quelques protéines identifiées par LC-MALDI-MS/MS et présentant des homologies de séquence avec la nouvelle PLA2.

Protein	Accession number	Species	Molecular mass (kDa)	Peptide number	Scaffold protein confidence index
ammodytin I2 (A)	gi  50874464	<i>Vipera b. berus</i>	14	3	100
ammodytin I2 (A) isoform	gi  50874456	<i>Vipera a. ruffoi</i>	13.5	2	99.8
phospholipase A2	gi  6967298	<i>Vipera ammodytes</i>	13.5	3	100
ammodytin I2(C) isoform	gi  50874498	<i>Vipera a. meridionalis</i>	13.7	3	100

Further biological characterization of PLA2 showed that it displays a powerful anti-aggregative effect on human platelet and induces an inflammatory response characterized by leukocytosis in the peripheral blood along with a release of mediators IL-6, EPO and complement system (results not shown).

## Conclusion

The newly identified PLA2 was characterized and proteomically analyzed by LC-MALDI-MS/MS. This PLA2 shares sequence homology with other PLA2 purified from snake venoms. It revealed to be a new molecule since it presents only 51% sequence homology with the PLA2 previously purified from the *C. cerastes* venom (Laraba-Djebari and Martin-Eauclaire, 1990).

## References

- Chérifi F, Laraba-Djebari F (2008) Mise en évidence et caractérisation d'une fraction coagulante et agrégante du venin de *Cerastes cerastes*. In *Toxines et fonctions cholinergiques neuronales et non neuronales*. Benoit E, Goudey-Perrière F, Marchot P et Servent D (eds) pp 324-325. Publications de la SFET, Châtenay-Malabry, France, Epub on <http://www.sfet.asso.fr> (ISSN 1760-6004)
- Chérifi F, Laraba-Djebari F (2009) Réponse inflammatoire induite par la fraction coagulante C1 isolée du venin de *Cerastes cerastes*. In *Toxines et signalisation*. Benoit E, Goudey-Perrière F, Marchot P et Servent D (eds) pp 165-167. Publications de la SFET, Châtenay-Malabry, France, Epub on <http://www.sfet.asso.fr> (ISSN 1760-6004)
- Laraba-Djebari F, Martin-Eauclaire MF (1990) Purification and characterization of a phospholipase A2 from *Cerastes cerastes* (Horn Viper) snake venom. *Toxicon* **28**: 637-646
- Kini RM (1997) Venom phospholipase A<sub>2</sub> enzymes: structure, function and mechanism. pp 1-511. Chichester, England
- Laraba-Djebari F, Martin-Eauclaire MF, Marchot P (1992) A fibrinogen-clotting serine proteinase from *Cerastes cerastes* (Horned viper) with arginine-esterase and amidase activities, purification, characterization and kinetic parameter determination. *Toxicon* **30**: 1399-1410
- Laraba-Djebari F, Martin-Eauclaire MF, Mauco G, Marchot P (1995) Afaâcytine, an  $\alpha,\beta$ -fibrinogenase from *Cerastes cerastes* (Horned viper) venom, activates purified factor X and induces serotonin release from human blood platelet. *Eur J Biochem* **233**: 756-765

## **Bacterial type IV secretion systems : structure of the core and outer-membrane complexes**

Rémi FRONZES

Unité G5 biologie structurale de la sécrétion bactérienne and URA2185-CNRS, Institut Pasteur, 25-28 rue du Dr Roux, F-75015 Paris, France

Tel : +33 (0)1 4568 8864 ; Fax : +33 (0)1 4568 8592 ; E-mail : [remi.fronzes@pasteur.fr](mailto:remi.fronzes@pasteur.fr)

---

### **Abstract**

*In Gram-negative bacteria, type IV secretion (T4S) systems form ATP-powered complexes that span the entire cellular envelope and secrete a wide variety of substrates from single proteins to protein–protein and protein–DNA complexes. Recent structural data, namely the electron microscopy structure of the T4S core complex and the atomic resolution structure of its outer-membrane pore, have profoundly altered our understanding of T4S architecture and mechanism.*

### **Architecture des systèmes bactériens de sécrétion de type IV**

*Les bactéries à Gram-négatif utilisent les appareils de sécrétion de type IV pour sécréter divers substrats vers l'extérieur de la cellule. Ces substrats sont de nature et de taille variable allant d'une petite protéine isolée à de gros complexes protéine-protéine ou protéine-ADN. Au cours de deux études récentes, nous avons obtenu de nouvelles données structurales concernant le cœur protéique du système de sécrétion de type IV qui ont profondément bouleversé notre compréhension de ces systèmes.*

**Keywords :** *Cryo-electron microscopy, horizontal gene transfer, membrane protein complex, protein secretion, X-ray crystallography.*

---

## **Introduction**

During various cellular processes, cells need to release macromolecules into their environment. Known as secretion, this process is common to all living cells. Gram-negative bacteria have a cell envelope made of two membranes separated by a thin layer of peptidoglycans. They developed six different types of specialized "molecular machine", also named secretion systems, for this function (*Figure 1*). Recently, some important information about the structure and, thus, the mechanism of the type IV secretion (T4S) systems has been obtained (Chandran *et al.*, 2009; Fronzes *et al.*, 2009). Gram-negative bacteria utilise T4S systems for several purposes (Waksman and Fronzes, 2010). These systems play an important role in the pathogenesis of diseases including stomach ulcers (caused by *Helicobacter pylori*), Legionnaire's disease (caused by *Legionella pneumophila*) and whooping cough (caused by *Bordetella pertussis*) by mediating the release of bacterial toxins into eukaryotic cells. In addition, T4S systems that are encoded by conjugative plasmids or transposons are used to propagate genes from one bacterium to another during horizontal gene transfer events, promoting for example the spread of antibiotic resistance among pathogenic bacteria.

## **Structure of the type IV secretion core complex**

T4S systems have been best studied in *Agrobacterium tumefaciens*. In this plant pathogen, which is widely used to transform plants, the complete secretion system comprises 12 different proteins named VirB1 to VirB11 and VirD4. A core of four proteins made of VirB7, VirB8, VirB9, and VirB10 has been described in the literature (Christie *et al.*, 2005; Das and Xie, 2000). The core complex from the conjugative T4S system encoded by the plasmid pKM101 from *Escherichia coli* has been purified (Fronzes *et al.*, 2009). Biochemical work demonstrated that it forms a large 1 MegaDalton complex spanning the two membranes and consisting of 14 copies of each of the proteins. Cryo-electron microscopy (Cryo-EM) was used to determine its structure at 15Å (1.5x10<sup>-10</sup> m) resolution (Fronzes *et al.*, 2009). This study revealed a two-layer, double-walled structure, with the inner wall of each layer forming a hollow chamber (*Figure 2*). Further investigations placed one layer within the inner membrane and the other within the outer-membrane, so they were named the inner (I) and outer (O) layers respectively. The inner layer is closed off at the base, resembling a cup; its two walls merge together at the base of the cup, and its outer edge is linked to the outer layer by thin linkers. The outer layer consists of a main body and a narrower cap on the outermost side of the complex (*Figure 2*).

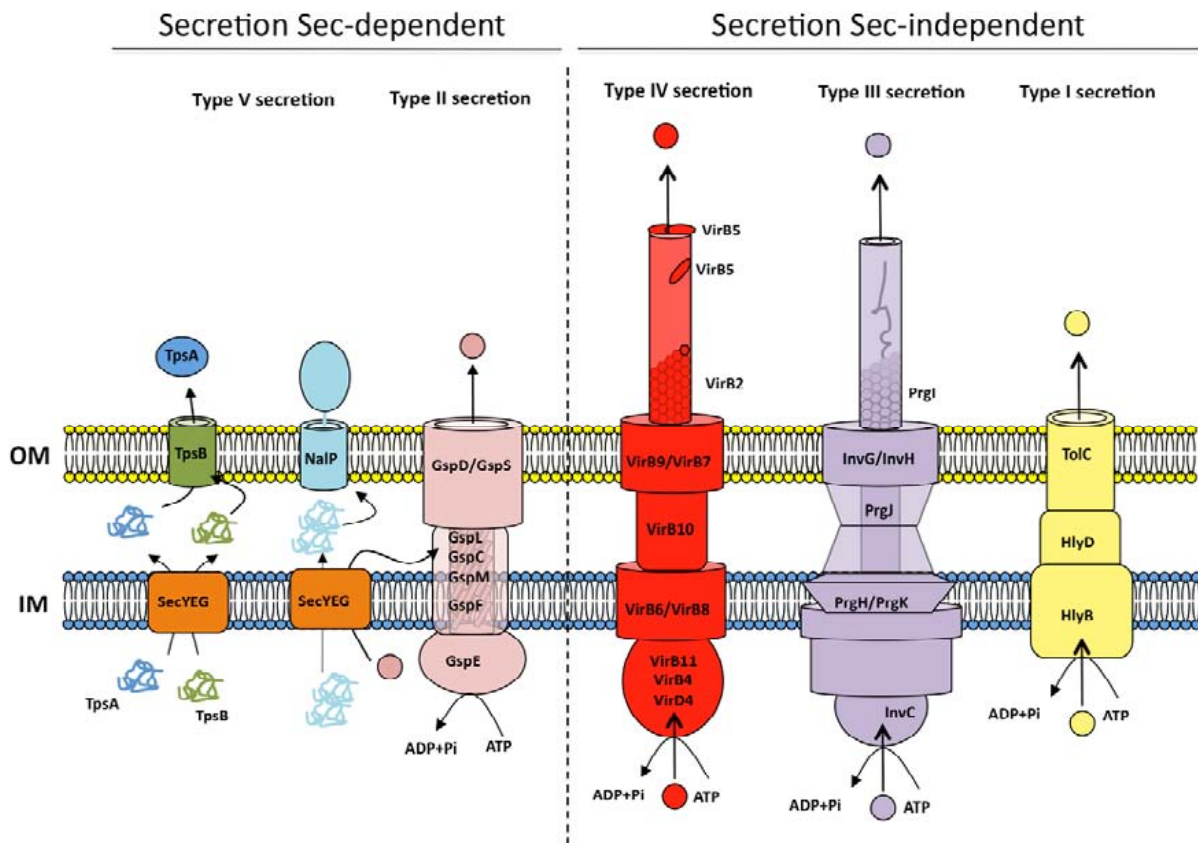

**Figure 1. Schematic overview of the major protein secretion systems in Gram-negative bacteria.** The bacterial secretion systems represented from left to right are: Type V secretion systems (*i.e.* NalP autotransporter from *Neisseria meningitidis* and two partner secretion systems) (Henderson and Nataro, 2001; Mazar and Cotter, 2007), type II secretion systems (Filloux, 2004), Type IV secretion systems (*i.e.* *Agrobacterium tumefaciens*) (Waksman and Fronzes, 2010), type III secretion systems (*i.e.* *Salmonella typhimurium*) (Cornelis and Van Gijsegem, 2000) and type I secretion systems (*i.e.* hemolysin secretion in *E. coli*) (Omori and Idei, 2003). Type VI secretion systems are not represented (Cascales, 2008; Pukatzki *et al.*, 2009).

**Figure 1. Vue schématique des principaux systèmes de sécrétion des bactéries à Gram-négatif.** Les systèmes de sécrétion bactériens sont représentés de gauche à droite : Systèmes de sécrétion de type V (Henderson and Nataro, 2001; Mazar and Cotter, 2007), de type II (Filloux, 2004), de type IV (Waksman and Fronzes, 2010), de type III (Cornelis and Van Gijsegem, 2000) et de type I (Omori and Idei, 2003). Les systèmes de sécrétion de type VI ne sont pas représentés (Cascales, 2008; Pukatzki *et al.*, 2009).

## Structure of the type IV outer-membrane complex

Limited proteolysis was used to remove parts of the proteins. The complexes formed from the remaining proteins were imaged using Cryo-EM, in order to locate the individual proteins within the complex. A sub-complex, with the N terminal parts of both VirB9 and VirB10 removed, showed an intact outer layer. This indicated that the outer layer is composed of the C terminal regions of VirB9 (VirB9CTD) and VirB10 (VirB10CTD), and the whole of VirB7. The crystal structure of this sub-complex has been recently obtained (Chandran *et al.*, 2009). This elegant structure shows that the outer-membrane complex consists of fourteen identical copies of a tightly bound hetero-trimer of VirB7, VirB9CTD and VirB10CTD, arranged in a ring of 172Å in diameter. Both VirB7 and VirB10CTD make extensive contacts with VirB9CTD, but not with each other (Figure 3). The VirB7/VirB9CTD complex or VirB10CTD structures is similar to previously determined NMR and crystal structures of the isolated proteins (Bayliss *et al.*, 2007; Terradot *et al.*, 2005). In this new structure, VirB10CTD has a long "lever arm" at its N-terminus that contacts hetero-trimers located in each of the three positions to either side within the ring (Figure 3).

The crystal structure of the outer-membrane complex demonstrates that the O-layer cap forms the outer membrane channel of T4S systems. This cap is made of a ring of fourteen two-helix bundles, one from each VirB10 monomer and that these helices (also named antenna) project through the outer membrane (Figures 2 and 3). These enclose a narrow channel of 32Å in diameter (Figure 2). The discovery that the outer-membrane pore was formed from the VirB10 homolog was particularly interesting, as part of the N-terminus of VirB10 was already known to include a helix spanning the inner membrane. VirB10 and its homologs can therefore be expected to span both outer and inner membranes. They are, so far, the only proteins known to have this property.

## T4S core and outer-membrane complex

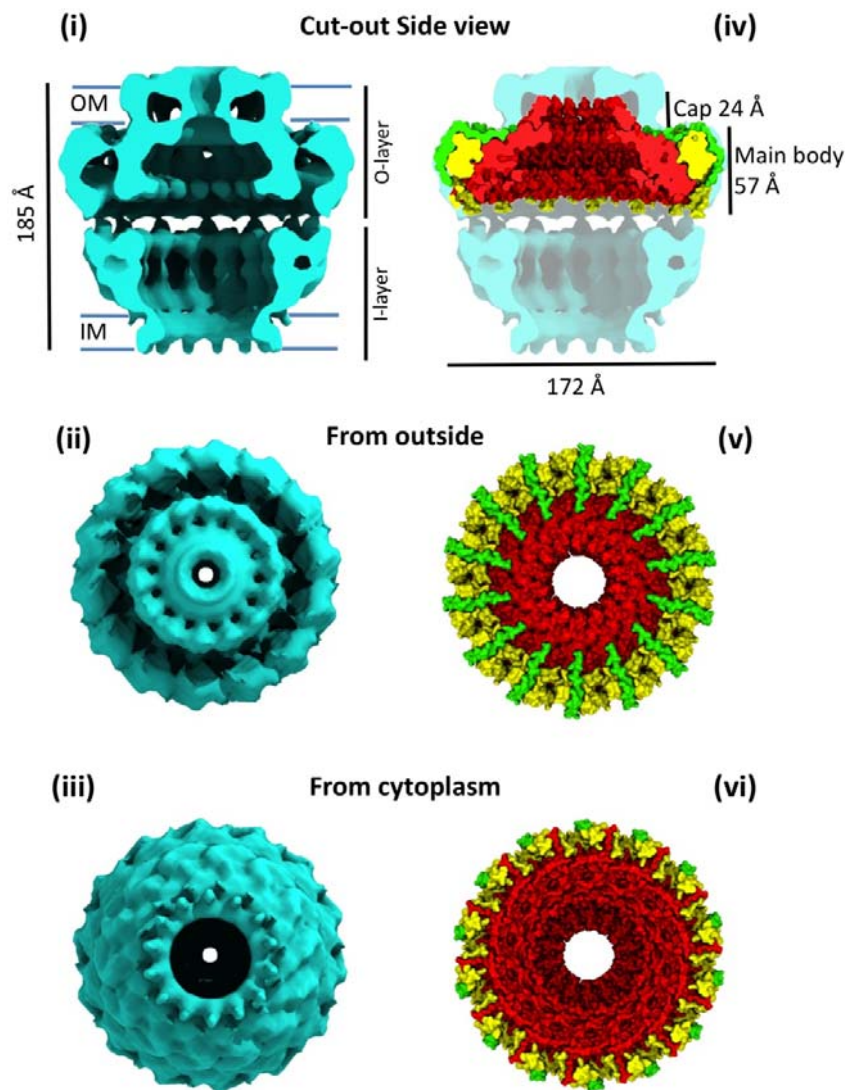
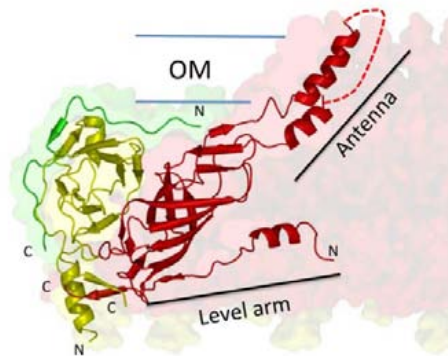

**Figure 2. Cryo-EM and crystal structures of the T4S core and outer-membrane complexes.** This figure details and compares the cryo-EM structure of the T4S core complex (in cyan) and the crystal structure of the T4S outer-membrane complex (the VirB10CTD, VirB9CTD and VirB7 are in red, yellow and green respectively). (i-iii): Surface rendering of the cryo-EM structure of the T4S tetradecameric core complex composed of VirB7, VirB9 and VirB10. The core complex forms a cylindrical object composed of two layers, the I-layer and O-layer, inserted respectively in the inner- and outer-membranes (IM and OM). (i): Cut-out side view of the complex showing that each layer forms a double-walled ring-like structure that defines internal hollow chambers. (ii): View of the core complex from the extracellular milieu. (iii): View of the core complex from the cytoplasm. (iv-vi): Surface rendering of the crystal structure of the T4S tetradecameric outer-membrane complex. The main body is made of the VirB10CTD, the VirB9CTD and VirB7. The cap is composed of the VirB10 trans-membrane helical antennas. (iv): cut-out side view of the complex. The VirB10CTD forms an inner ring surrounded by the VirB9–VirB7 complex. (v): view of the complex from the extracellular milieu. (vi): view of the complex from the periplasm.

**Figure 2. Structure du cœur protéique et du complexe de la membrane externe d'un appareil de sécrétion de type IV.** Cette figure détaille et compare la structure du cœur protéique obtenue par cryo-microscopie électronique (en cyan) et la structure cristalline du complexe de la membrane externe obtenue par cristallographie RX (le domaine C-terminal de VirB10 (VirB10CTD) est en rouge, le domaine C-terminal de VirB9 (VirB9CTD) en jaune et VirB7 en vert). (i-iii): Représentation de surface de la structure obtenue par cryo-microscopie électronique du cœur protéique d'un appareil de sécrétion de type IV. Ce cœur est un complexe tétradécamérique de l'hétéro-trimère formé par les protéines VirB10, VirB9 et VirB7. Il s'agit est un objet cylindrique qui est formé de deux anneaux nommés I-layer et O-layer et qui sont respectivement insérés dans la membrane interne (IM) ou la membrane externe (OM). (i): Vue transversale du complexe montrant que chaque anneau délimite une large cavité à l'intérieur du complexe. (ii): Vue du cœur depuis le milieu extracellulaire. (iii): Vue du cœur depuis le cytoplasme. (iv-vi): Représentation de surface de la structure cristalline du complexe de la membrane externe. L'anneau est composé VirB10CTD, VirB9CTD et VirB7. Le chapeau est composé de deux hélices de VirB10 (iv) : Vue transversale du complexe. VirB10CTD forme la partie interne de l'anneau alors que le complexe VirB9–VirB7 est en périphérie. (v): Vue du complexe depuis le milieu extracellulaire. (vi): Vue du complexe depuis le périplasm.



### VirB7-VirB9CT-VirB10CT heterotrimer



**Figure 3. Crystal structure of the VirB7, VirB9CTD and VirB10CTD heterotrimer** (ribbon representation). The N- and C- termini of the three proteins are indicated by N and C. The fourteen copies of the VirB10 antenna are inserted in the outer-membrane (OM) and form a pore. The N-terminal extremity of the VirB10CTD forms an N-terminal lever arm that contacts three other VirB10CTDs within the complex.

**Figure 3. Structure cristalline de l'hétérotrimère VirB7, VirB9CTD, VirB10CTD.** Les extrémités N- et C-terminales des trois protéines sont indiquées par N et C. Les quatorze copies des hélices formant l'antenne (antenna) de VirB10CTD sont insérées dans la membrane externe et forment un pore. L'extrémité N-terminale de VirB10CTD forme un bras N-terminal qui est en contact avec trois autres VirB10CTD.

## Conclusion

Superposition of the cryo-EM and X-ray structures reveals differences between the two structures leading to some interesting speculations about the mechanism of substrate secretion through T4S systems (Chandran *et al.*, 2009). As VirB10 and its homologs span both bacterial membranes, they are uniquely placed to pass conformational changes from ATPases in the inner-membrane bound part of the complex up through the system, allowing secretion to take place through the outer membrane. This could be mediated through the extensive contacts that the VirB10 lever arm makes with both neighbouring and more distant subunits (Chandran *et al.*, 2009). Compounds that inhibit these interactions would be expected to interfere with the workings of this complex "nano-machine" and might prove useful as drugs against diseases such as ulcers, whooping cough, or Legionnaire's disease.

## References

- Bayliss R, Harris R, Coutte L, Monier A, Fronzes R, Christie PJ, Driscoll PC, Waksman G (2007) NMR structure of a complex between the VirB9/VirB7 interaction domains of the pKM101 type IV secretion system. *Proc Natl Acad Sci USA* **104**: 1673-1678
- Cascales E (2008) The type VI secretion toolkit. *EMBO Rep* **9**: 735-741
- Chandran V, Fronzes R, Duquerroy S, Cronin N, Navaza J, Waksman G (2009) Structure of the outer membrane complex of a type IV secretion system. *Nature* **462**: 1011-1015
- Christie PJ, Atmakuri K, Krishnamoorthy V, Jakubowski S, Cascales E (2005) Biogenesis, architecture, and function of bacterial type IV secretion systems. *Annu Rev Microbiol* **59**: 451-485
- Cornelis GR, Van Gijsegem F (2000) Assembly and function of type III secretory systems. *Annu Rev Microbiol* **54**: 735-774
- Das A, Xie YH (2000) The Agrobacterium T-DNA transport pore proteins VirB8, VirB9, and VirB10 interact with one another. *J Bacteriol* **182**: 758-763
- Filloux A (2004) The underlying mechanisms of type II protein secretion. *Biochim Biophys Acta* **1694**: 163-179
- Fronzes R, Schafer E, Wang L, Saibil HR, Orlova EV, Waksman G (2009) Structure of a type IV secretion system core complex. *Science* **323**: 266-268
- Henderson IR, Nataro JP (2001) Virulence functions of autotransporter proteins. *Infect Immun* **69**: 1231-1243
- Mazar J, Cotter PA (2007) New insight into the molecular mechanisms of two-partner secretion. *Trends Microbiol* **15**: 508-515
- Omori K, Idei A (2003) Gram-negative bacterial ATP-binding cassette protein exporter family and diverse secretory proteins. *J Biosci Bioeng* **95**: 1-12
- Pukatzi S, McAuley SB, Miyata ST (2009) The type VI secretion system: translocation of effectors and effector-domains. *Curr Opin Microbiol* **12**: 11-17
- Terradot L, Bayliss R, Oomen C, Leonard GA, Baron C, Waksman G (2005) Structures of two core subunits of the bacterial type IV secretion system, VirB8 from *Brucella suis* and ComB10 from *Helicobacter pylori*. *Proc Natl Acad Sci USA* **102**: 4596-4601
- Waksman G, Fronzes R (2010) Molecular architecture of bacterial type IV secretion systems. *Trends Biochem Sci*, in press

## **Three-dimensional structures of two neurotoxic phospholipases A<sub>2</sub>, ammodytoxin and crotoxin, are resolved : impact of structural differences on functional effects**

Grazyna FAURE<sup>\*</sup>, Frederick SAUL

Unité d'Immunologie Structurale, Institut Pasteur, 25 rue du Dr. Roux, F-75724 Paris, France

<sup>\*</sup> Corresponding author ; Tel : +33 (0)1 4568 8686 ; Fax : +33 (0)1 4061 3057 ;

E-mail : [grazyna.faure-kuzminska@pasteur.fr](mailto:grazyna.faure-kuzminska@pasteur.fr)

---

### **Abstract**

Monomeric ammodytoxin (Atx) and heterodimeric crotoxin (CA-CB) are potent  $\beta$ -neurotoxins from the venoms of the snakes *Vipera ammodytes ammodytes* and *Crotalus durissus terrificus*. They act presynaptically, inducing complete failure of neuromuscular transmission, and also exhibit anticoagulant effects (Faure and Saul, 2008). To exert their neurotoxicity and anticoagulant activity, these secreted group IIA phospholipases A<sub>2</sub> (sPLA<sub>2</sub>) interact with several protein targets such as calmodulin (CaM) and human coagulation factor Xa (FXa) (Faure, 2002; Pungercar and Krizaj, 2007; Faure et al., 2010). Recently, we have determined the crystal structures of two ammodytoxin isoforms, AtxA and AtxC (Saul et al., 2010) and one isoform of a heterodimeric crotoxin complex (Saul and Faure, submitted). The crystal structures of the two natural Atx isoforms reveal the conformation of specific amino-acid residues linked to anticoagulant and neurotoxic activity. The three-dimensional structure of crotoxin establishes the nature of the binding interface between the two subunits and provides a structural basis to explain functional effects induced by the acidic subunit (CA).

### **Les structures tridimensionnelles de deux phospholipases A<sub>2</sub> neurotoxiques, l'ammodytoxine et la crotoxine, sont résolues : impact des différences structurales sur les effets fonctionnels**

L'ammodytoxine (Atx) et la crotoxine (CA-CB) sont des neurotoxines  $\beta$  des venins de serpents (*Vipera ammodytes ammodytes* et *Crotalus durissus terrificus*) qui inhibent la transmission neuromusculaire au niveau présynaptique en interagissant avec différents récepteurs protéiques tels que la calmoduline et d'autres récepteurs neuronaux (Faure and Saul, 2008; Pungercar and Krizaj, 2007). Ces enzymes à activité phospholipase A<sub>2</sub> (PLA<sub>2</sub>) sont également capables d'inhiber la coagulation sanguine par leur liaison directe au facteur de coagulation humain Xa (Faure, 2002; Faure et al., 2010). Nos études ont permis la résolution des structures cristallographiques de deux isoformes naturelles de l'Atx (Saul et al., 2010) et une forme hétérodimerique de la CA-CB (Saul and Faure, soumis). La comparaison des structures tridimensionnelles des deux isoformes de l'Atx explique les différences fonctionnelles (différences observées dans la neurotoxicité et l'activité anticoagulante). La structure cristallographique de la crotoxine a mis en évidence les résidus localisés à l'interface entre les deux sous-unités (CA et CB) et a permis de mieux comprendre le rôle fonctionnel de la sous-unité CA.

**Keywords :** Ammodytoxin, anticoagulant phospholipases A<sub>2</sub>, crotoxin, crystal structure, presynaptic neurotoxins.

---

## **Introduction**

Group IIA phospholipases A<sub>2</sub> (sPLA<sub>2</sub>) from snake venoms are multifunctional proteins with diverse toxic and pharmacological effects arising from hydrolysis of phospholipids or from highly specific binding to protein targets (e.g. to presynaptic receptors, PLA<sub>2</sub>-inhibitors from snake serum and human blood-coagulation factors; Faure, 2002). Since understanding the molecular mechanisms of PLA<sub>2</sub> action can aid in the development of new anticoagulant or anti-neurotoxic agents, we have characterized the interaction of neurotoxic and anticoagulant PLA<sub>2</sub> with their proteic receptors by mutagenesis, affinity binding studies and X-ray crystallography.

## **PLA<sub>2</sub>-FXa interaction**

From affinity binding studies by Surface Plasmon Resonance and *in vitro* assay of prothrombinase inhibition, we

showed that ammodytoxin, a neurotoxic phospholipase A<sub>2</sub>, and the CB subunit of crotoxin inhibit blood coagulation by binding to the human blood coagulation factor FXa *via* a non-catalytic, PL-independent mechanism (Faure, 2002; Prijatelj *et al.*, 2006). We showed that AtxA binds to FXa ( $K_d^{app} = 32$  nM), inhibiting the activity of the prothrombinase complex ( $IC_{50} = 20$  nM). The AtxA mutants, expressed in *E. coli* to map the FXa interaction site, suggested that binding occurs at the C-terminal and  $\beta$ -wing regions. Various PLA<sub>2</sub> from exogenous sources such as snake venoms, are specific blood coagulation inhibitors that interact with human FXa. Using affinity binding studies and theoretical bioinformatics methods (molecular docking simulations between *Viperidae* snake venom PLA<sub>2</sub>s and FXa), we modelised the interface regions of sPLA<sub>2</sub>s and FXa (Figure 1; Faure *et al.*, 2007). We proposed a potential PLA<sub>2</sub>-binding site on FXa located on the exosite of the heavy chain and EGF-like domains in the light chain of FXa. The potential FXa binding site on PLA<sub>2</sub> is composed of the helices A and B, the Ca<sup>2+</sup> loop, the helix C- $\beta$ -wing loop and the C-terminal fragment. Our findings may lead to the design of novel, non-competitive FXa inhibitors (Faure *et al.*, 2007; for review see Faure *et al.*, 2010).

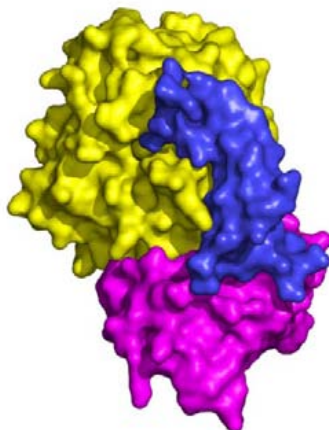
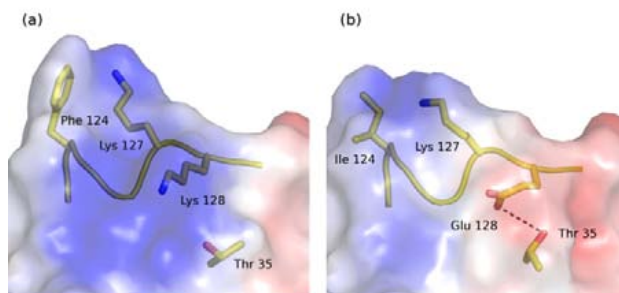

**Figure 1.** 3D model of the complex between AtxA (in magenta) and the light and heavy chains of FXa (in blue and yellow, respectively), based on modelisation by Faure *et al.* (2007).

**Figure 1.** Modèle tridimensionnel du complexe entre l'AtxA (en rose), la chaîne légère du facteur de coagulation humain Xa (en bleu) et sa chaîne lourde (en jaune), d'après Faure *et al.* (2007).

## Determination of the crystal structure of two isoforms of Atx

The crystal structures of two natural isoforms of ammodytoxin have been determined: AtxA and AtxC, resolution 1.7 Å and 1.3 Å, respectively (Figure 2; Saul *et al.*, 2010). The isoforms differ at two amino-acid positions (Phe124>Ile and Lys128>Glu) but display significant differences in toxicity and anticoagulant properties: highly toxic AtxA interacts with FXa with high affinity ( $K_d^{app} = 30$  nM) whereas less toxic AtxC interacts with 10-fold lower affinity ( $K_d^{app} = 346$  nM; Prijatelj *et al.*, 2006).



**Figure 2.** View of the C-terminal region in the crystal structures of AtxA (a) and AtxC (b). Interaction between Glu128 and the main chain nitrogen atom of Thr35 in AtxC leads to a shift in the side chain of unmutated Lys127 and explains the low affinity for FXa and low anticoagulant activity. From Saul *et al.*, 2010.

**Figure 2.** Vue détaillée de la partie C-terminale de la structure cristallographique de l'AtxA (a) et l'AtxC (b). L'interaction entre la Glu128 et la Thr35 conduit à un déplacement de la chaîne latérale de la Lys127, à l'origine d'une perte d'affinité pour le facteur de coagulation humain Xa et d'une faible activité anticoagulante. D'après Saul *et al.*, 2010.

Detailed analyses of the AtxA and AtxC structures establish how these mutations could lead to differences in neurotoxicity and anticoagulant activity and help to explain the role of natural mutations in the binding of PLA<sub>2</sub>

with FXa (Saul *et al.*, 2010). Interestingly, the natural mutation of Lys128>Glu in AtxC leads to a shift in the side chain of the adjacent unmutated residue Lys127 (Figure 2). This different orientation of Lys127 together with the observed displacement of the main chain at positions 127 and 128 could explain the 10-fold decrease in affinity of AtxC for FXa. The significant differences in toxicity between the two isoforms could be essentially due to the differences in surface complementarity in the interaction of the toxin with neurotoxic protein receptor (Figure 2).

The crystal structures of the Atx isoforms also revealed a novel dimeric conformation, with two parallel N-terminal  $\alpha$ -helices making important hydrophobic contacts between the two monomers (Saul *et al.*, 2010). Sedimentation equilibrium experiments confirmed the presence of both monomer and dimer in solution. The AtxA dimer possesses two neurotoxic sites located in the C-terminal regions and could increase accessible surface for interaction with neurotoxic receptors.

### PLA<sub>2</sub>-CaM interaction

AtxA interacts with high (nanomolar) affinity with CaM and this interaction plays an important role in determining the specific neurotoxic function of AtxA (Pungercar and Krizaj, 2007). By competition experiments, we confirmed that the binding sites on AtxA for CaM and FXa partially overlap and involve the C-terminal region (Saul *et al.*, 2010). A theoretical model of the Atx-CaM complex proposed by Kovacic *et al.* (2010) is shown in Figure 3.

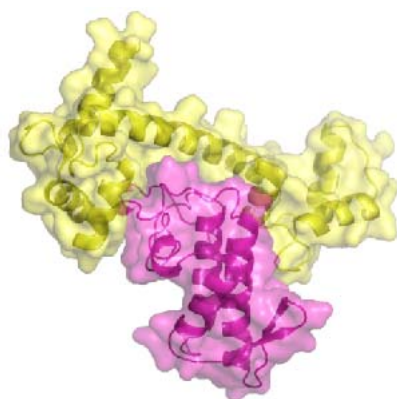

**Figure 3.** Theoretical three-dimensional model of the complex between AtxA (in magenta) and CaM (in yellow), based on Kovacic *et al.* (2010).

**Figure 3.** Modèle tridimensionnel du complexe AtxA-CaM (AtxA est en vert et CaM en jaune), d'après Kovacic *et al.* (2010).

### Crotoxin CA-CB interaction

We have solved the crystal structure of heterodimeric crotoxin from *Crotalus durissus terrificus* venom (Figure 4; Saul and Faure, *submitted*). Crotoxin is a potent  $\beta$ -neurotoxin formed by the non-covalent association of a basic PLA<sub>2</sub> subunit CB and an acidic, non-enzymatic and non-toxic subunit CA. The acidic subunit has three disulfide-linked polypeptide chains ( $\alpha, \beta, \gamma$ ) generated by post-translational maturation of the precursor pro-CA (Bouchier *et al.*, 1991; Faure *et al.*, 1991).

The CA subunit, a natural inhibitor of the catalytic activities of CB, enhances by 10-fold the lethality of CB, playing an important synergistic role in the increased toxicity of the crotoxin complex. The CA subunit participates together with CB in binding to the specific crotoxin presynaptic receptor forming a transient ternary complex, followed by the release of CA (Faure *et al.*, 2003). Crotoxin displays a number of other pharmacological effects including a preferential cytotoxic activity against various types of tumor cells and is used for the treatment of carcinomas (Cura *et al.*, 2002).

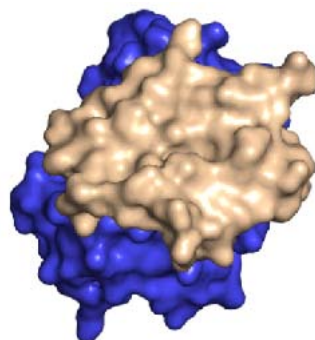

**Figure 4.** Three-dimensional structure of the crotoxin complex (CB in blue, CA in white), Saul and Faure (*submitted*).

**Figure 4.** Structure tridimensionnelle de la forme hétérodimérique de la crotoxine (CB en bleu, CA en blanc), Saul et Faure (*soumis*).

The crystal structure of crotoxin reveals the nature of the binding interface between the two subunits and provides a structural basis to explain functional effects induced by the acidic subunit (Saul and Faure, submitted).

## Conclusions

The crystal structures of AtxA and AtxC help to explain their significant functional differences. The C-terminal region, important for the neurotoxic properties of PLA<sub>2</sub>, is fully exposed and accessible for interaction with proteic receptors (CaM and FXa) in both the monomeric and dimeric forms of Atx and in the heterodimeric complex of crotoxin. Knowledge of the three-dimensional structure of the anticoagulant snake venom PLA<sub>2</sub>s and their sites of interaction with FXa and CaM at the level of specific amino acid residues could lead to an understanding of hemostatic and neurotoxic processes at the molecular level and help in finding novel anticoagulant or antineurotoxic inhibitors.

## References

- Bouchier C, Boulain JC, Bon C, Ménez A (1991) Analysis of cDNAs encoding the two subunits of crotoxin, a phospholipase A<sub>2</sub> neurotoxin from rattlesnake venom: the acidic non enzymatic subunit derives from a phospholipase A<sub>2</sub>-like precursor. *Biochim Biophys Acta* **1088**: 401-408
- Cura JE, Blanzaco DP, Brisson C, Cura MA, Carbol R, Larrateguy L, Mendez C, Sech JC, Silveira JS, Theiller E, de Roodt AR, Vidal JC (2002) Phase I and Pharmacokinetics study crotoxin (cytotoxic PLA<sub>2</sub> NSC-624 244) in patients with advanced Cancer. *Clin Cancer Res* **8**: 1033-1041
- Faure G, Guillaume JL, Camoin L, Saliou B, Bon C (1991) Multiplicity of acidic subunit isoforms of crotoxin, the phospholipase A<sub>2</sub> neurotoxin from *Crotalus durissus terrificus* venom, results from posttranslational modifications. *Biochemistry* **30**: 8074-8083
- Faure G (2002) Les différentes cibles protéiques des phospholipases A<sub>2</sub> de venins de serpents. In *Toxines et recherches biomédicales*, Collection Rencontres en Toxinologie. Goudey-Perrière F, Bon C, Puiseux-Dao S, Sauviat MP (eds) pp 305-313. Paris: Elsevier
- Faure G, Copic A, Le Porrier S, Gubensek F, Bon C, Krizaj I (2003) Crotoxin acceptor protein isolated from *Torpedo* electric organ : binding properties to crotoxin by surface plasmon resonance. *Toxicon* **41**: 509-517
- Faure G, Gowda VT, Maroun R (2007) Characterization of a human coagulation factor Xa-binding site on phospholipases A<sub>2</sub> from *Viperidae* snake venom by affinity binding studies and molecular bioinformatics. *BMC-Struct Biol* **7**: 82
- Faure G, Saul F (2008) Caractéristiques structurales et fonctionnelles de deux β-neurotoxines : l'ammodytoxine et la crotoxine. In *Toxines et fonctions cholinergiques neuronales et non neuronales*. Benoit E, Goudey-Perrière F, Marchot P et Servent D (eds) pp 155-160. Publications de la SFET, Châtenay-Malabry, France, Epub on <http://www.sfet.asso.fr> (ISSN 1760-6004)
- Faure G, Xu H, Saul F (2010) Anticoagulant Phospholipases A<sub>2</sub> which bind to the specific soluble receptor Coagulation Factor Xa (Chapter 13). In *Toxins and Hemostasis: From Bench to Bedside*. Kini RM, Clemetson K, Markland FS, McLane MA, Morita T (eds) 1<sup>st</sup> Edition. Springer Science+Business Media B.V. (ISBN 978-90-481-9294-6)
- Kovacic L, Novinec M, Petan T, Krizaj I (2010) Structural basis of the significant calmodulin-induced increase in the enzymatic activity of secreted phospholipases A<sub>2</sub>. *Protein Eng Des Sel* **23**: 479-487
- Prijatelj P, Charnay M, Ivanovski G, Jenko Z, Pungercar J, Krizaj I, Faure G (2006) The C-terminal and β-wing regions of ammodytoxin A, a neurotoxic phospholipase A<sub>2</sub> from *Vipera ammodytes ammodytes*, are critical for binding to factor Xa and for anticoagulant effect. *Biochimie* **88**: 69-76
- Pungercar J, Krizaj I (2007) Understanding the molecular mechanism underlying the presynaptic toxicity of secreted phospholipases A<sub>2</sub>. *Toxicon* **50**: 871-892
- Saul F, Prijatelj-Znidarsic P, Vuillez-le Normand B, Villette B, Raynal B, Pungercar J, Krizaj I, Faure G (2010) Comparative structural studies of two natural isoforms of ammodytoxin, phospholipases A<sub>2</sub> from *Vipera ammodytes* which differ in neurotoxicity and anticoagulant activity. *J Struct Biol* **169**: 360-369
- Saul F, Xu H, Faure G (submitted) Crystal structure of crotoxin, a potent heterodimeric neurotoxic phospholipase A<sub>2</sub> from *Crotalus durissus terrificus* venom
-

## **Molecular dynamics studies of Acetylcholine Binding Protein with spiroimine toxins**

Rómulo ARÁOZ<sup>1</sup>, Laurent CHABAUD<sup>2</sup>, Catherine GUILLOU<sup>2</sup>, Jordi MOLGÓ<sup>1</sup>, Bogdan I. IORGA<sup>2\*</sup>

<sup>1</sup> CNRS, Centre de Recherche de Gif sur Yvette FRC 3115, Institut de Neurobiologie Alfred Fessard FRC 2118, Laboratoire de Neurobiologie et Développement UPF 3294, 1 avenue de la Terrasse, F-91198 Gif sur Yvette, France ; <sup>2</sup> CNRS, Centre de Recherche de Gif sur Yvette FRC 3115, Institut de Chimie des Substances Naturelles UPF 2301, 1 avenue de la Terrasse, F-91198 Gif sur Yvette, France

\* Corresponding author ; Tel : +33 (0)1 6982 3094 ; Fax : +33 (0)1 6907 7247  
E-mail : [bogdan.iorga@icsn.cnrs-gif.fr](mailto:bogdan.iorga@icsn.cnrs-gif.fr)

---

### **Abstract**

The dynamics of the interaction between two spiroimine toxins, gymnodimine A and 13-desmethyl spiroside C, with Acetylcholine Binding Protein (AChBP) has been explored using molecular modelling techniques. A two-step protocol has been used for flexible docking of the macrocyclic toxins at the AChBP subunit interface. Subsequent molecular dynamics simulations, in the presence and in the absence of the ligand, provided useful insight into the receptor conformational changes induced by ligand binding, as well as the contribution of different ligand fragments to the overall protein-ligand interactions.

### **Etude par dynamique moléculaire de l'interaction de l'Acetylcholine Binding Protein avec des toxines de type spiroimine**

La dynamique de l'interaction de deux toxines de type spiroimine, gymnodimine A et 13-desméthyle spiroside C, avec l'Acetylcholine Binding Protein (AChBP) a été étudiée par modélisation moléculaire. Une procédure en deux étapes a été utilisée pour le docking flexible de ces toxines macrocycliques à l'interface de deux sous-unités de l'AChBP. Des simulations de dynamique moléculaire, réalisées en présence et en absence du ligand, ont révélé des informations intéressantes concernant les changements conformationnels induits par la fixation du ligand, ainsi que la contribution des différents fragments du ligand à l'interaction globale entre la protéine et le ligand.

**Keywords :** 13-Desmethyl spiroside C, Acetylcholine Binding Protein, gymnodimine A, molecular dynamics, spiroimine toxins.

---

## **Introduction**

Macrocyclic spiroimine phycotoxins belong to an emerging class of chemical agents associated with marine algal blooms and shellfish toxicity (Molgó *et al.*, 2007). Representative members of this family are gymnodimines, spiroalides, pinnatoxins, pteriatoxins, and spiro-prorocentrimine. Gymnodimine A and 13-desmethyl spiroside C have been shown to be potent antagonists of nicotinic acetylcholine receptor (nAChR), and have prompted the development of new tools to detect these spiroimine toxins in shellfish and for the design of novel drugs (Kharrat *et al.*, 2008; Bourne *et al.*, 2010). Very recently, the X-ray crystal structures of Acetylcholine Binding Protein (AChBP) in complex with gymnodimine A and 13-desmethyl spiroside C were solved, thus providing essential information regarding the orientation and the conformation adopted by these ligands in the binding pocket and their interactions with neighbouring amino-acid residues (Bourne *et al.*, 2010).

In this work we have explored the dynamics of the interaction between gymnodimine A and 13-desmethyl spiroside C with AChBP, starting from the crystallographic structures recently published.

## **Materials and Methods**

Three-dimensional coordinates of the ligands were generated using Corina software (v3.44, <http://www.molecular-networks.com/>).

All conformational search calculations were carried out using MacroModel (v9.7, <http://www.schrodinger.com/>) with the default values, with the exception of a conformer energy window of 42 kJ/mol within the Mixed MCMM/Low-Mode search protocol.

Gold software (v4.1, Verdonk *et al.*, 2003) was used for molecular docking calculations, the binding site being defined as a sphere with a 15 Å radius centered on the coordinates of the ligand iminium nitrogen atom

in the original crystal structure (Bourne *et al.*, 2010). The GoldScore scoring function was used, all other parameters having default values.

Molecular dynamics simulations were carried out with GROMACS version 4.0.7 (Hess *et al.*, 2008) using the OPLS-AA (Jorgensen *et al.*, 1996) force field. The simulation box, obtained after hydration and neutralization with Na<sup>+</sup> and Cl<sup>-</sup> ions to physiological pH (150 mM), contained about 150,000 atoms (protein, ligand, water and ions). Each system was energy-minimized until convergence using a steepest descents algorithm. Molecular dynamics with position restraints for 200 ps was then performed followed by the production run of 20 ns (in the presence of ligand) or 50 ns (in the absence of ligand). During the position restraints and production runs, the Parinello-Rahman method (Parinello *et al.*, 1981) was used for pressure coupling, and the temperature was coupled using the Nosé-Hoover method (Nosé, 1984) at 300 K. Electrostatics were calculated with the particle mesh Ewald method (Essman *et al.*, 1995). The P-LINCS algorithm (Hess, 2007) was used to constrain bond lengths, and a time step of 2 fs was used throughout. Ligand topologies for the OPLS-AA force field were obtained using an in-house developed script.

Images were generated with Chimera (Pettersen *et al.*, 2004) and MD analysis plots with Xmgrace (<http://plasma-gate.weizmann.ac.il/Grace/>).

All calculations were performed using the high-performance computing (HPC) facilities at the Institut de Chimie des Substances Naturelles, Gif sur Yvette, France.

## Results and Discussion

Gymnodimine A and 13-desmethyl spirolide C are two important members of the spirotoxin family that show important structural similarities (Figure 1). The main differences between these structures are present on the spiroimine ring and on the 5:5:6 spiroketal moiety, which are responsible for the differences in activity and selectivity against AChBP and various subtypes of nAChRs previously reported (Bourne *et al.*, 2010).

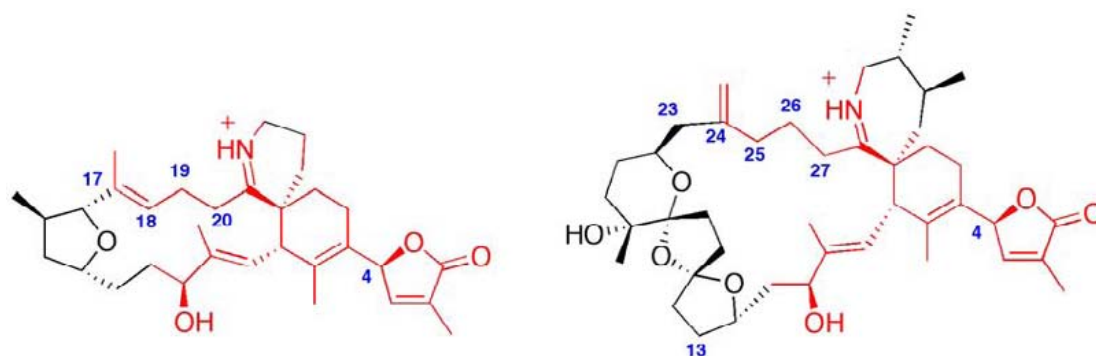

**Figure 1.** Chemical structures of gymnodimine A (left) and 13-desmethyl spirolide C (right). The common substructure shared by these toxins is coloured in red.

**Figure 1.** Structures chimiques de la gymnodimine A (gauche) et de la 13-desméthyle spirolide C (droite). La sous-structure commune de ces deux toxines est colorée en rouge.

The initial protein coordinates used in this study have been taken from the crystal structures of AChBP in complex with gymnodimine A and 13-desmethyl spirolide C published recently (PDB codes 2X00 and 2WZY, Bourne *et al.*, 2010). As there were some differences in the ligand structures reported in the AChBP-spiroimine complexes (Bourne *et al.*, 2010) and in the literature (Seki *et al.*, 1995 ; Stewart *et al.*, 1997 ; Hu *et al.*, 2001 ; Falk *et al.*, 2001 ; Ciminiello *et al.*, 2009), the ligand conformations in the binding site have been built by molecular docking. Most of the chiral configurations are conserved for equivalent atoms across the spirotoxins family. However, for H-4 the *S* configuration has been assigned from the X-ray structure of the *p*-bromobenzamide derivative of gymnodamine (Stewart *et al.*, 1997) and from NMR studies of a recently isolated 5:6 dispiroketal toxin (Roach *et al.*, 2009), whereas the *R* configuration has been assigned from NMR and molecular modelling studies of 13,19-didesmethyl spirolide C (Ciminiello *et al.*, 2009). In this work, the H-4 *S* configuration, which seems more probable from the experimental data available to date, has been used throughout.

As no docking software is presently able to deal natively with the macrocycle flexibility, a two-step approach has been used to build the active conformations of the two spirotoxins. In the first step, a conformational search produced an ensemble of conformers (containing 40 conformers for gymnodimine A and 61 conformers for 13-desmethyl spirolide C), which has been subsequently used in the docking process. The best docking pose has been selected and used in the molecular dynamics (MD) simulation of the protein-ligand complex.

Four MD simulations have been carried out, using two different structures of AChBP, in the presence and in the absence of the corresponding spiroimine toxin (Table 1). In order to limit the system size, only two AChBP subunits have been considered in the MD simulations.

**Table 1.** Overview of the molecular dynamics simulations carried out in this study, using AChBP with and without the spiroimine toxins.

**Tableau 1.** Résumé des simulations de dynamique moléculaire réalisées dans le cadre de cette étude, en utilisant l'AChBP en présence et en absence des toxines de type spiroimine.

	AChBP protein structure	Ligand	Simulation time (ns)
<b>MD1</b>	2X00	–	50
<b>MD2</b>	2X00	gymnodimine A	20
<b>MD3</b>	2WZY	–	50
<b>MD4</b>	2WZY	13-desmethyl spirolide C	20

No significant movement of the ligands in the binding site at the interface of the two subunits is observed during the MD simulations (*Figure 2*). In MD2, a small closing movement of the loop C is observed, to better envelop the gymnodimine A ligand, which allows the establishment of a new hydrogen bond between Ser189 and the alcohol group of gymnodimine A. This closing movement is induced by the presence of ligand, since it is not observed in MD1, where, on the contrary, the loop C undergoes an opening movement. The hydrogen bond between the ligand iminium group and the backbone carbonyl oxygen atom of Trp147 is conserved all over the simulation time, whereas the hydrogen bonds between the butyrolactone ring and the side chains of residues Gln186 and Tyr188 are lost due to significant changes in side chain conformations.

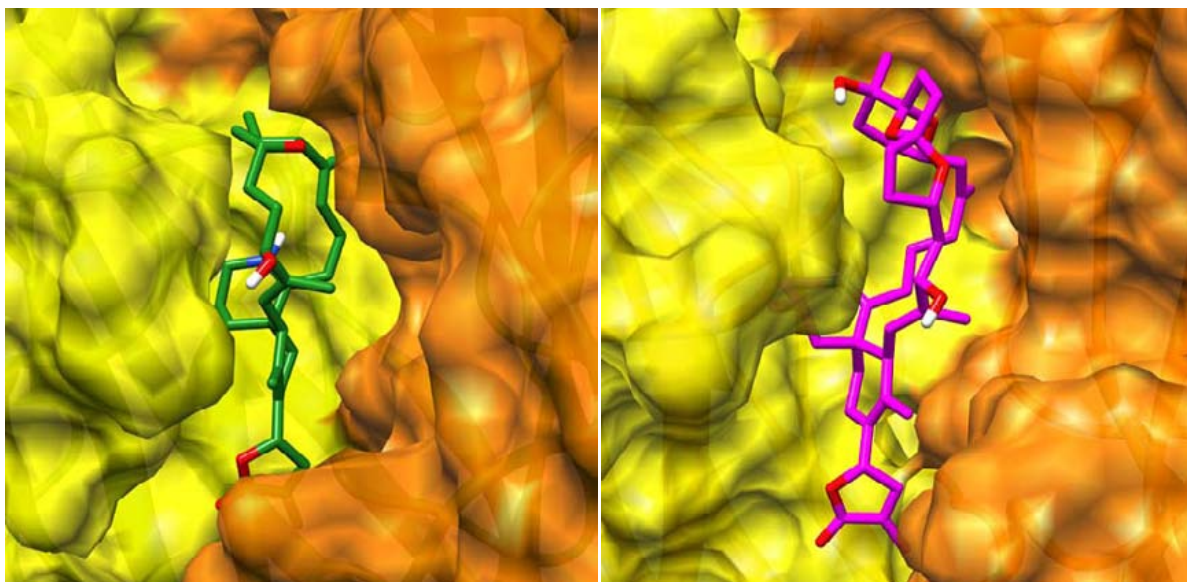

**Figure 2.** Gymnodimine A (green, **left**) and 13-desmethyl spirolide C (magenta, **right**) in the AChBP binding site after 20 ns MD simulation.

**Figure 2.** Gymnodimine A (vert, **gauche**) et 13-desméthyle spirolide C (magenta, **droite**) dans le site de fixation de l'AChBP après une simulation de dynamique moléculaire de 20 ns.

In a similar manner, in MD4, a closing movement of the loop C is observed in the presence of 13-desmethyl spirolide C, whereas no substantial change of the loop C could be evidenced in the absence of ligand, in MD3. The hydrogen bonds between the iminium group with Trp147 and between the alcohol group at C-19 and Tyr195 are conserved during the simulation, but the interactions between the butyrolactone ring with Lys143 and Tyr188 residues are lost. As previously reported (Bourne *et al.*, 2010), no major interactions are observed between these ligands and the loop F.

The average values of protein-ligand contact surfaces are 790 Å<sup>2</sup> for gymnodimine A (min and max values 600 Å<sup>2</sup> and 960 Å<sup>2</sup>, respectively) and 870 Å<sup>2</sup> for 13-desmethyl spirolide C (min and max values 600 Å<sup>2</sup> and 1100 Å<sup>2</sup>, respectively). These values account for the bigger size of 13-desmethyl spirolide C compared to gymnodimine A, and implies that the former ligand has a greater contribution of the van der Waals interactions to the overall protein-ligand interaction energy than the latter.

Root mean square deviation (RMSD) plots as a function of time during the MD simulations are presented in *Figure 3*. The protein chains have reached a plateau at 1.7–2.2 Å after a few nanoseconds, whereas for the ligands the plateau is situated at 0.6–0.7 Å. In the case of 13-desmethyl spirolide C (MD4), a small increase in RMSD is observed at 10 ns, which is due to a conformational switch of the fragment 23-27 (*Figure 1*). This



second conformation has also been observed in the ensemble of conformers obtained for 13-desmethyl spiroamide C. This shows that the AChBP binding site can accommodate a limited conformational flexibility of the ligand, although no conformational changes have been observed for the side chains of surrounding residues Ile118 and Trp147. The same conformational switch could not be observed for gymnodimine A in the region 17-20 (*Figure 1*), neither in the ensemble of conformers or during the MD simulation, probably because of the greater rigidity of this fragment induced by the presence of an endocyclic double bond.

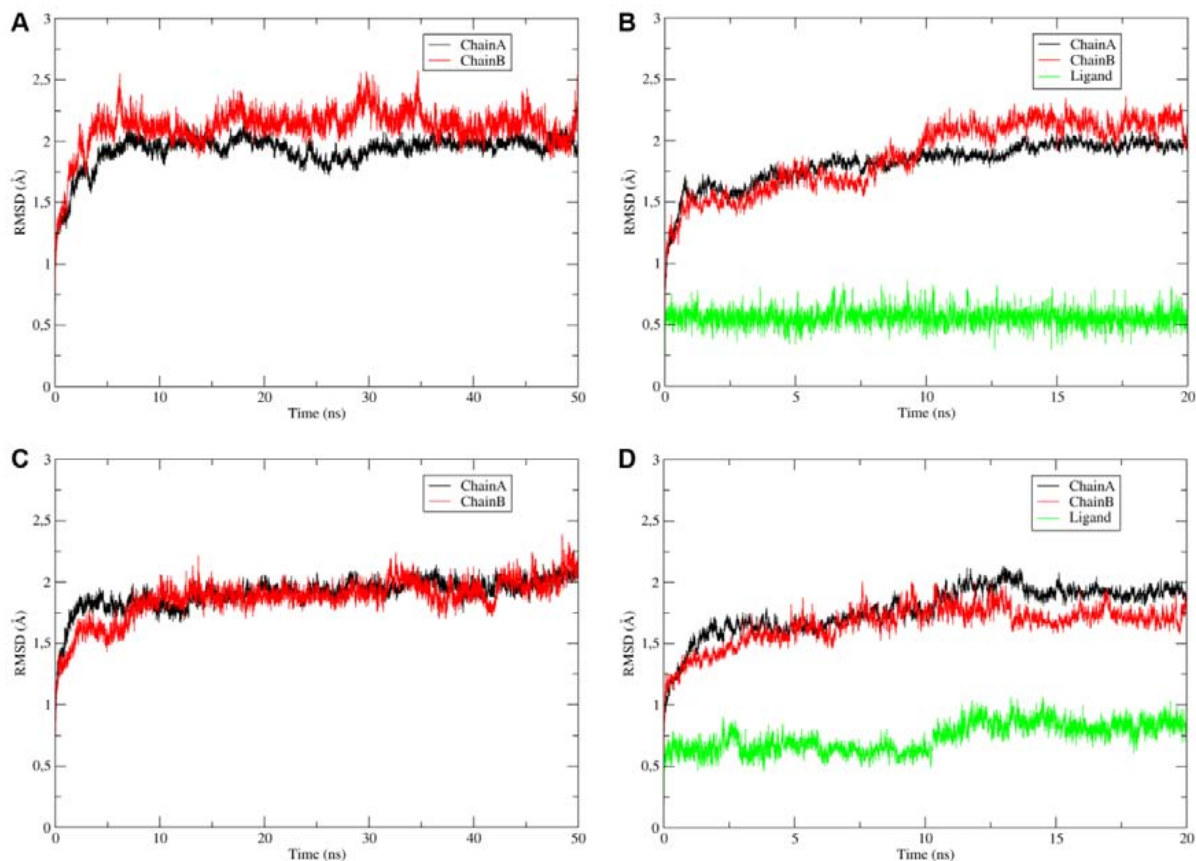

**Figure 3.** RMSD plots for protein chains and ligands in MD1 (A), MD2 (B), MD3 (C) and MD4 (D) simulations.

**Figure 3.** Représentation de l'écart quadratique moyen pour les chaînes protéiques et les ligands dans les simulations MD1 (A), MD2 (B), MD3 (C) et MD4 (D).

Root mean square fluctuation (RMSF) plots for the  $C_{\alpha}$  of protein, presented in *Figure 4*, show a greater flexibility for the region 184-196, which represents the loop C. This is in agreement with the mechanism of ligand binding, involving loop C opening/closing and with the conclusions of previous MD studies (Gao *et al.*, 2005 ; Amiri *et al.*, 2007). The flexibility of loop C is dramatically reduced in the presence of a bound ligand at the subunit interface (*Figure 4*, red plot).

Another region with increased flexibility in MD simulations is around Arg16. This region also shows higher B-factors in the crystal structures (Bourne *et al.*, 2010), but this seems not to be related with the ligand binding process.

## Conclusion

In this work we have investigated the dynamics of the interaction between two spiroimine toxins, gymnodimine A and 13-desmethyl spiroamide C, with AChBP. A two-step procedure has been used for flexible docking of these macrocyclic toxins in the binding site at the subunit interface. Molecular dynamics simulations, in the presence and in the absence of the ligand, provided additional information regarding the stability and evolution in time for key protein-ligand interactions. The hydrogen bond between iminium group of both ligands and Trp147, and to a lesser extent, the hydrogen bond between the spiroketal moiety of 13-desmethyl spiroamide C and Tyr195, have been found to be essential for the stability of the protein-ligand complex, whereas the contribution of the butyrolactone ring seems to be relatively limited. RMSD and RMSF data allowed the identification of flexible regions in the protein and in the ligand structures, and the calculation of protein-ligand contact surface showed that, due to ligand size, there are differences in the contribution of hydrophobic interactions to the global ligand binding affinity.

**Acknowledgements.** This work was supported in part by Grant PCV07-194417-NEUROSPIROIIMINE from the Agence Nationale de la Recherche (France). R.A. was supported by a grant from EU 7<sup>th</sup> Frame Program STC-CP2008-1-555612 (ATLANTOX).

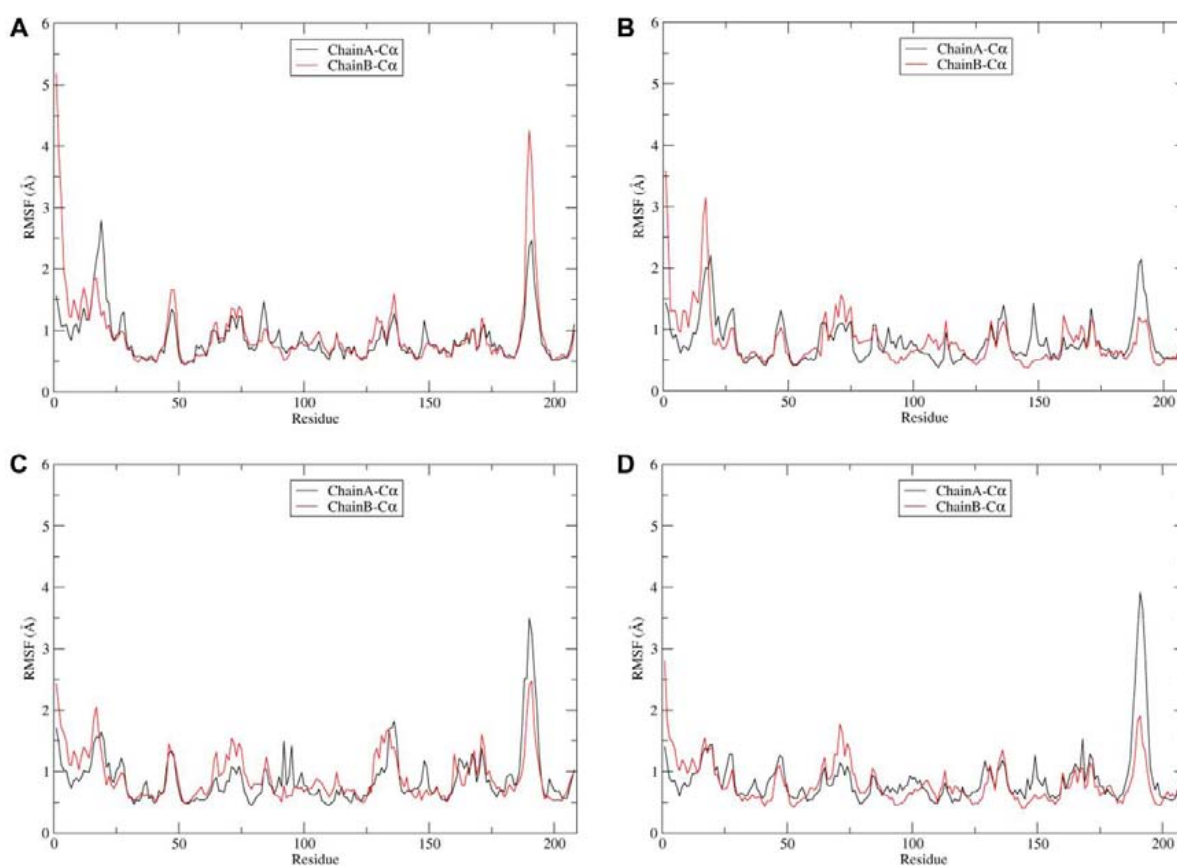

**Figure 4.** RMSF plots for  $C\alpha$  of protein chains in MD1 (A), MD2 (B), MD3 (C) and MD4 (D) simulations.

**Figure 4.** Représentation de la fluctuation quadratique moyenne pour les  $C\alpha$  des chaînes protéiques dans les simulations MD1 (A), MD2 (B), MD3 (C) et MD4 (D).

## References

- Amiri S, Sansom MS, Biggin PC (2007) Molecular dynamics studies of AChBP with nicotine and carbamylcholine: The role of water in the binding pocket. *Protein Eng Des Sel* **20**: 353-359
- Bourne Y, Radic Z, Aráoz R, Talley TT, Benoit E, Servent D, Taylor P, Molgó J, Marchot P (2010) Structural determinants in phycotoxins and AChBP conferring high affinity binding and nicotinic AChR antagonism. *Proc Natl Acad Sci USA* **107**: 6076-6081
- Ciminiello P, Catalanotti B, Dell'aversano C, Fattorusso C, Fattorusso E, Forino M, Grauso L, Leo A, Tartaglione L (2009) Full relative stereochemistry assignment and conformational analysis of 13,19-didesmethyl spirolide C via NMR- and molecular modeling-based techniques. A step towards understanding spirolide's mechanism of action. *Org Biomol Chem* **7**: 3674-3681
- Essmann U, Perera L, Berkowitz M, Darden T, Lee H, Pedersen L (1995) A smooth particle mesh Ewald method. *J Chem Phys* **103**: 8577-8593
- Falk M, Burton IW, Hu T, Walter JA, Wright JLC (2001) Assignment of the relative stereochemistry of the spirolides, macrocyclic toxins isolated from shellfish and from the cultured dinoflagellate *Alexandrium ostenfeldii*. *Tetrahedron* **57**: 8659-8665
- Gao F, Bren N, Burghardt TP, Hansen S, Henchman RH, Taylor P, McCammon JA, Sine SM (2005) Agonist-mediated conformational changes in acetylcholine-binding protein revealed by simulation and intrinsic tryptophan fluorescence. *J Biol Chem* **280**: 8443-8451
- Hess B (2007) P-LINCS: A parallel linear constraint solver for molecular simulation. *J Chem Theory Comput* **4**: 116-122
- Hess B, Kutzner C, van der Spoel D, Lindahl E (2008) GROMACS 4: Algorithms for highly efficient, load-balanced, and scalable molecular simulation. *J Chem Theory Comput* **4**: 435-447
- Hu T, Burton IW, Cembella AD, Curtis JM, Quilliam MA, Walter JA, Wright JL (2001) Characterization of spirolides A, C, and 13-desmethyl C, new marine toxins isolated from toxic plankton and contaminated shellfish. *J Nat Prod* **64**: 308-312
- Jorgensen WL, Maxwell DS, Tirado-Rives J (1996) Development and testing of the OPLS all-atom force field on conformational energetics and properties of organic liquids. *J Am Chem Soc* **118**: 11225-11236
- Kharrat R, Servent D, Girard E, Ouanounou G, Amar M, Marrouchi R, Benoit E, Molgó J (2008) The marine phycotoxin gymnodimine targets muscular and neuronal nicotinic acetylcholine receptor subtypes with high affinity. *J Neurochem* **107**: 952-963
- Molgó J, Girard E, Benoit E (2007) The cyclic imines: an insight into this emerging group of bioactive marine toxins. In *Phycotoxins: Chemistry and Biochemistry*, Hui YH, Botana LM (eds) pp 319-355. Oxford: Blackwell Publishing
- Nosé S (1984) A molecular dynamics method for simulations in the canonical ensemble. *Molec Phys* **52**: 255-268

- Parrinello M, Rahman A (1981) Polymorphic transitions in single crystals: A new molecular dynamics method. *J Appl Phys* **52**: 7182-7190
- Pettersen EF, Goddard TD, Huang CC, Couch GS, Greenblatt DM, Meng EC, Ferrin TE (2004) UCSF Chimera—a visualization system for exploratory research and analysis. *J Comput Chem* **25**: 1605-1612
- Roach JS, Leblanc P, Lewis NI, Munday R, Quilliam MA, Mackinnon SL (2009) Characterization of a dispiroketal spiroside subclass from *Alexandrium ostenfeldii*. *J Nat Prod* **72**: 1237-1240
- Seki T, Satake M, Mackenzie L, Kaspar HF, Yasumoto T (1995) Gymnodimine, a new marine toxin of unprecedented structure isolated from New Zealand oysters and the dinoflagellate, *Gymnodinium sp.* *Tetrahedron Lett* **36**: 7093-7096
- Stewart M, Blunt JW, Munro MH, Robinson WT, Hannah DJ (1997) The absolute stereochemistry of the New Zealand shellfish toxin gymnodimine. *Tetrahedron Lett* **38**: 4889-4890
- Verdonk ML, Cole JC, Hartshorn MJ, Murray CW, Taylor RD (2003) Improved protein-ligand docking using GOLD. *Proteins* **52**: 609-623
-

## **Engineering KcsA-Kv1.x chimeric proteins for studying toxin-channel interactions**

Christian LEGROS<sup>1\*</sup>, Max GOYFFON<sup>2</sup>, Catherine GUETTE<sup>3</sup>

<sup>1</sup> RCIM UPRES EA2646 /USC INRA 2023/ IFR n° 149 QUASAV, Université d'Angers, 2 Bd Lavoisier, F-49045 Angers cedex, France ; <sup>2</sup> Laboratoire Ecosystèmes et Interactions Toxiques, USM 0505, Muséum National d'Histoire Naturelle, 18 rue Buffon, F-75005 Paris, France ; <sup>3</sup> Centre Inserm Régional de Recherche sur le Cancer U892, Centre Régional de Lutte Contre le Cancer Paul Papin, 2 rue Moll, F-49033 Angers, France

\* Corresponding author ; Tel : +33 (0)2 4173 5067 ; Fax : +33 (0)2 4173 5215 ;  
E-mail : christian.legros@univ-angers.fr

---

### **Abstract**

Since its discovery 15 years ago by Schrempf et al. (1995), the K<sup>+</sup> channel from *Streptomyces lividans*, KcsA, has become one of the most cited and best known of K<sup>+</sup> channels. Its crystal structure has provided a unique opportunity to analyse structure-function relationships of its eukaryotic homologs belonging to the family of voltage-gated K<sup>+</sup> channels (or Kv channel). Structural conservation of KcsA pore region and by the eukaryotic K<sup>+</sup> channels has opened new approaches for studying the interaction of animal toxins with their targets, including docking modelling and new screening method using mass spectrometry.

### **Ingénierie des protéines KcsA-Kv1.x chimériques pour étudier les interactions toxines-canaux**

Depuis sa découverte, il y a 15 ans, par Schrempf et al. (1995), le canal K<sup>+</sup> de *Streptomyces lividans*, KcsA, est devenu un des canaux K<sup>+</sup> les plus cités et les mieux caractérisés. La résolution de sa structure cristalline a procuré une occasion unique d'analyser les relations structure-fonction des homologues eucaryotes appartenant à la famille des canaux K<sup>+</sup> dépendants du potentiel (ou canaux Kv). La conservation structurale de la région du pore du KcsA par les canaux eucaryotes a permis le développement de nouvelles approches pour étudier les interactions de toxines animales avec leurs cibles, incluant la modélisation d'interaction et de nouvelles méthodes de criblage utilisant la spectrométrie de masse.

**Keywords :** Animal toxins, K<sup>+</sup> channel, mass spectrometry, molecular docking, toxins interaction.

---

## **Introduction**

Voltage-gated K<sup>+</sup> channels (Kv channels) constitute a superfamily of ion channels involved in many cellular functions, such as neuronal signalling, regulation/modulation of synaptic transmission, regulation of the heart electrical properties, and regulation of the potential membrane of T lymphocytes (Pongs and Legros, 2000). The study of the physiological significance of K<sup>+</sup> channel functions has been helped by the discovery of peptidyl blockers isolated from bee, scorpion, snake, sea anemone, snail and spider venoms (Harvey, 1993; Swartz et al., 2007; Miller, 1995). Even if animal toxins have provided essential tools to probe the structure and function of K<sup>+</sup> channels, the lack of direct structural information has been a break to understand the detailed features of ion selectivity for example. Analysis of bacterial genomes has permitted to unmask K<sup>+</sup> channel pore-loop forming region sequences in genes from many species, such as KcsA of *Streptomyces lividans* (Schrempf et al., 1995) and LctB of *Bacillus stearothermophilus* (Wolter et al., 1999).

Fortunately, the small size of the KcsA channel with only two transmembrane regions connected by a linker containing an unmistakable pore region motif that is also found in Kv channels (67% identity over 21 residues without deletions or insertions), has pushed this channel in a race for overexpression and crystallization studies (Cortes and Perozo, 1997; Heginbotham et al., 1997). One year later, the MacKinnon group published the first crystal structure of KcsA, at 3.2 Å resolution which revealed many of the structural details of ion selectivity (Doyle et al., 1998). Higher resolution crystal structures were published afterwards, revealing more molecular details concerning the activation and inactivation processes (Zhou et al., 2001; Uysal et al., 2009; Cuello et al., 2010). Structural conservation of the pore region in prokaryotic and eukaryotic K<sup>+</sup> channels has opened new approaches for studying K<sup>+</sup> channels toxins interaction, including docking modelling strategies (MacKinnon et al., 1998; Legros et al., 2000; Eriksson and Roux, 2002; Gao and Garcia, 2003).

Our project focused on the exploration of the use of KcsA to study the interactions of peptidyl scorpion toxin

with Kv channels. First, we showed that KcsA can serve as a molecular template, in which the pore-forming region is partially replaced by its counterpart in human Kv channels (Kv1.x) to bioengineer chimeric membrane proteins (KcsA-Kv1.x). Second, we developed an affinity-capture assay based on mass spectrometry analyses that may facilitate high-throughput screening of ligand libraries or animal venoms aimed at discovering novel Kv channel ligands.

### Generating a high affinity binding site for scorpion toxins in chimeric KcsA-Kv1.x channel

To explore the structural conservation of the pore region of KcsA, we constructed a chimeric channel in which the entire M1-M2 linker, including the pore region, was exchanged by its counterpart in human Kv1.3 channel (S5-S6 linker, *Figure 1*).

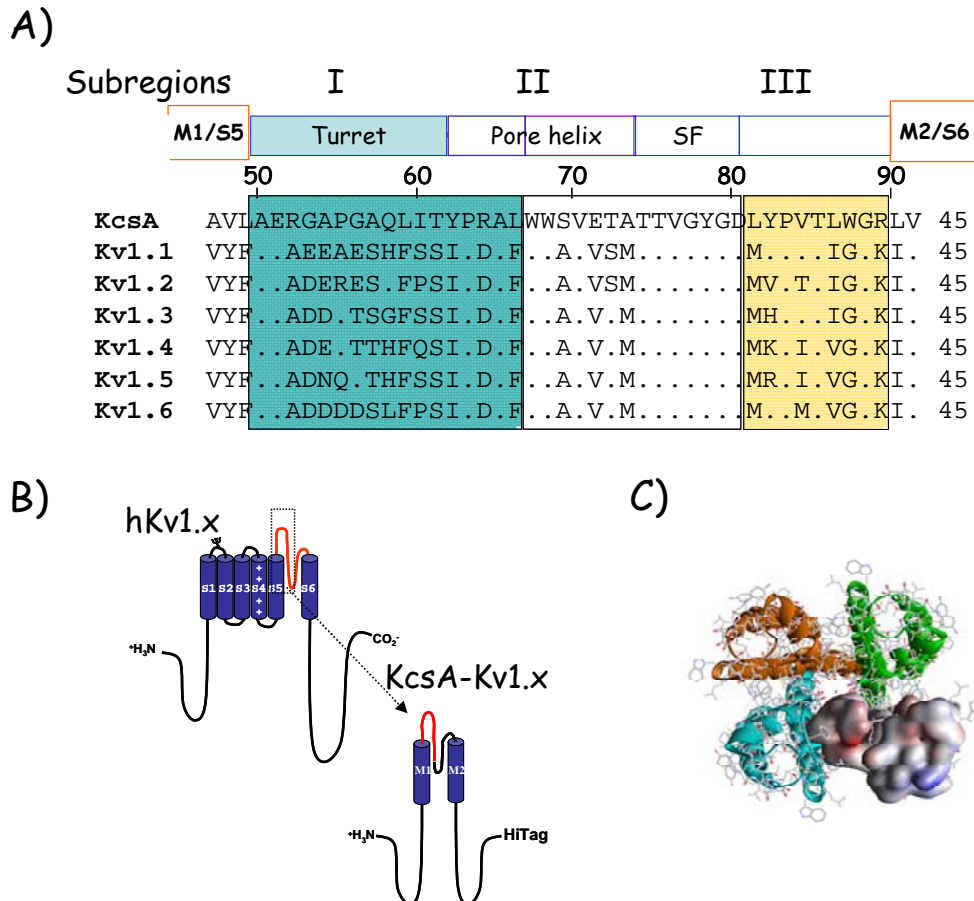

**Figure 1.** Generating mini chimeric KcsA-Kv1.x channels. **(A)** Alignment of the S5/M1-S6/M2 linker sequences of KcsA and human Kv1.1 to Kv1.6 subunits. **(B)** Schematic diagram showing the transfer of sub-region I sequences from Kv1.1 to Kv1.6 to KcsA for expression of KcsA-Kv1.x chimeras. **(C)** Top view of the KcsA-Kv1.x structural model. For clarity, the surface of one subunit is displayed.

**Figure 1.** Construction de canaux chimeriques KcsA-Kv1.x. **(A)** Alignement des séquences des boucles S5/M1-S6/M2 du KcsA and des canaux hKv1.1 à hKv1.6. **(B)** Schéma montrant le transfert des séquences de la sous-région I des hKv1.1 à hKv1.6 au KcsA pour l'expression de chimères KcsA-Kv1.x. **(C)** Vue de dessus d'un modèle structural de KcsA-Kv1.x. Pour plus de clarté, la surface de la sous-région I d'une seule sous-unité est représentée.

However, attempts to express this chimeric construct in *E. coli* were unsuccessful. The bacteria transformed by this first construct, stopped to grow after induction and died for unknown reasons. In contrast, KcsA-Kv1.3 chimeric proteins which contain only sub-region I of the S5-S6 linker of Kv1.3 could be expressed, detergent-solubilized and purified as tetramers in mg amounts (Legros *et al.*, 2000). Moreover, in binding experiments we found that this KcsA-Kv1.3 chimera acts as a high affinity receptor for the scorpion toxin kaliotoxin (KTX), a specific blocker of Kv1.1 and Kv1.3 channels (Legros *et al.*, 2000). To investigate whether sequence differences in sub-region I of Kv1.x channels correlates with the distinct pharmacological profiles of these channels towards peptidyl inhibitors, five KcsA-Kv1.x chimeras were constructed by replacing KcsA sub-region I with the corresponding sub-regions of human Kv1.1 and Kv1.2 and Kv1.4-Kv1.6 channels, respectively. Unfortunately, some of these chimeras were not overexpressed in *E. coli*. However, the pharmacological binding profile of KTX and hongotoxin1 (a scorpion peptidyl blocker of Kv1.1-Kv1.3 and Kv1.6) were faithfully transferred into KcsA-Kv1.X chimeras. Thus, we have engineered a panel of KcsA-Kv1.1-Kv1.6 proteins which mimic faithfully pharmacological properties of the parental Kv1.x channels (Legros *et al.*, 2002). In conclusion, we have shown

that KcsA structural template can be used to generate chimeric receptors to scorpion toxins and thus pertinent structural scaffolds for screening assays and docking modeling strategies.

Another interesting feature that we explored is the possibility to array the KcsA-Kv1.x chimeras on a solid support. The properties of the KcsA-Kv1.X chimeras were assessed in surface-plasmon-resonance (SPR) assays (Legros *et al.*, 2002). This technique, which allows one to access to high-quality kinetic and thermodynamic data for molecular interactions, is poorly employed for receptor-toxin interaction studies (Boozar *et al.*, 2006). Interestingly, KTX binding properties to KcsA-Kv1.3 chimeras linked to an inert chip-surface were similar to those determined by filtration techniques with purified channels. In conclusion, we showed that SPR assays using KcsA-Kv1.x represent an interesting way for studying scorpion toxin interactions (Legros *et al.*, 2007). In addition, we demonstrated as a proof-of-concept that it is possible to array KcsA-Kv1.x chimeras on a nitrocellulose-supported film without affecting their specific binding properties. Thus, the chimera properties are not affected by any immobilization process and could provide new approaches for rapid on-chip drug profiling and pharmacological screening studies.

### Affinity-capture of scorpion toxin and mass spectrometry analysis

#### Analysis of scorpion venom complexity and diversity using mass spectrometry

Over the past decade, mass spectrometry (MS) has undergone an extraordinary development in biological assays, protein identification, and drug discovery. Particularly, mass spectrometry techniques have become an essential method for studying the diversity of animal venoms, based on accurate molecular mass determination (Favreau *et al.*, 2006). Matrix-assisted laser desorption/ionization time-of-flight (MALDI-TOF) MS and nano-electrospray ionisation (nano-ESI) are both very sensitive and rapid methods for the analysis of low levels of peptidyl toxins in arthropod venoms (Legros *et al.*, 2004). Using a mass tandem spectrometer QqTOF, the complete sequence of peptidyl toxins could be obtained by nano-ESI MS/MS (Legros *et al.*, 2009). In addition, MS approaches provide useful tools for the discovery of novel compounds in screening assays.

#### Rapid characterization of affinity-captured toxins by mass spectrometry

In order to set up a screening assay based on MS detection, His-tagged KcsA-Kv1.3 chimeras were immobilized onto Ni-NTA magnetic agarose beads and incubated with various scorpions venoms (Legros *et al.*, 2009). The affinity-captured scorpion toxins were eluted prior to MALDI-TOF MS and nano-ESI MS/MS analysis (Figure 2).

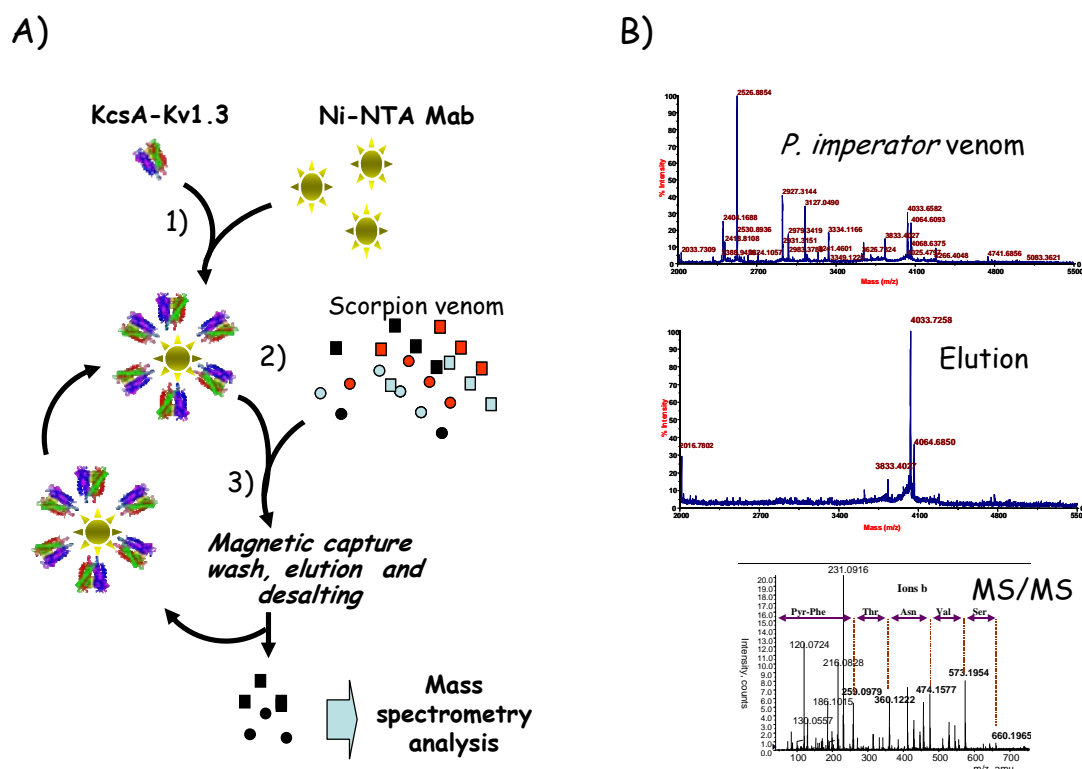

**Figure 2.** Affinity capture of scorpion toxin using KcsA-Kv1.x chimeras. (A) Affinity-capture procedure using a detergent-solubilized membrane protein immobilized onto Ni-NTA magnetic agarose beads (Ni-NTA Mab). (B) MALDI-TOF MS analysis of *P. imperator* venom and affinity captured peptide (elution) followed by MS/MS experiment for *de novo* sequencing.

**Figure 2.** Capture par affinité de toxines de scorpion en utilisant les chimères KcsA.1.x. (A) Schéma décrivant la procédure de capture par affinité employant des protéines membranaires solubilisées par des détergents et immobilisées sur des billes d'agarose magnétiques (Ni-NTA Mab). (B) Analyses par spectrométrie de masse MALDI-TOF du venin de *P. imperator* et la capture par affinité de peptides (élution) suivie d'une expérience de MS/MS pour un séquençage *de novo*.

When linked to magnetic beads, the chimeric detergent-solubilized membrane protein can be re-used several times without losing its selectivity or specificity. We applied the method to scorpion venoms from *Buthidae* and *Chactoidae* species, which are rich sources of potent peptidyl K<sup>+</sup> channels blockers. The *de novo* sequences of the affinity-captured scorpion toxins were deduced by combining the MS/MS fragmentation of the reduced form (up to the 33 first residues) and the trypsin-digested peptides of the native toxins.

## Conclusion

Owing to their remarkable biochemical properties, the use of KcsA-Kv1.x chimeric channel proteins offers a powerful and innovative way for studying the binding of animal toxins. Purified in the tetrameric form which is crucial for scorpion toxin binding, the KcsA-Kv1.x chimeras faithfully reconstitute the pharmacological profiles of the parental Kv1.x channels, even when linked to a solid support. These bio-engineered KcsA-Kv1.x proteins can be used in SPR assay for studying toxin channel interaction, and for MS screening of venoms for new toxins acting on Kv channels. This opens up the possibility for the discovery of new peptidyl toxins for pharmacologically orphan Kv channels.

## References

- Boozer C, Kim G, Cong S, Guan H, Londergan T (2006) Looking towards label-free biomolecular interaction analysis in a high-throughput format: a review of new surface plasmon resonance technologies. *Curr Opin Biotechnol* **17**: 400-405
- Cortes DM, Perozo E (1997) Structural dynamics of the *Streptomyces lividans* K<sup>+</sup> channel (SKC1): oligomeric stoichiometry and stability. *Biochemistry* **36**: 10343-10352
- Cuello LG, Jogini V, Cortes DM, Perozo E (2010) Structural mechanism of C-type inactivation in K<sup>+</sup> channels. *Nature* **466**: 203-208
- Doyle DA, Morais Cabral J, Pfuetzner R A, Kuo A, Gulbis J M, Cohen SL, Chait BT, MacKinnon R (1998) The structure of the potassium channel: molecular basis of K<sup>+</sup> conduction and selectivity. *Science* **280**: 69-77
- Eriksson MA, Roux B (2002) Modeling the structure of agitoxin in complex with the Shaker K<sup>+</sup> channel: a computational approach based on experimental distance restraints extracted from thermodynamic mutant cycles. *Biophys J* **83**: 2595-2609
- Favreau P, Menin L, Michalet S, Perret F, Cheneval O, Stöcklin M, Bulet P, Stöcklin R (2006) Mass spectrometry strategies for venom mapping and peptide sequencing from crude venoms: case applications with single arthropod specimen. *Toxicon* **47**: 676-687
- Gao YD, Garcia ML (2003) Interaction of agitoxin2, charybdotoxin, and iberiotoxin with potassium channels: selectivity between voltage-gated and Maxi-K channels. *Proteins* **52**: 146-154
- Gross A, Abramson T, MacKinnon R (1994) Transfer of the scorpion toxin receptor to an insensitive potassium channel. *Neuron* **13**: 961-966
- Harvey AL (1993) Neuropharmacology of potassium ion channels. *Med Res Rev* **13**: 81-104
- Heginbotham L, Lu Z, Abramson T, MacKinnon R (1994) Mutations in the K<sup>+</sup> channel signature sequence. *Biophys J* **66**: 1061-1067
- Heginbotham L, Odessey E, Miller C (1997) Tetrameric stoichiometry of a prokaryotic K<sup>+</sup> channel. *Biochemistry* **36**: 10335-10342
- Legros C, Pollmann V, Knaus HG, Farrell AM, Darbon H, Bougis PE, Martin-Eauclaire MF, Pongs O (2000) Generating a high affinity scorpion toxin receptor in KcsA-Kv1.3 chimeric potassium channels. *J Biol Chem* **275**: 16918-16924
- Legros C, Schulze C, Garcia ML, Bougis PE, Martin-Eauclaire MF, Pongs O (2002) Engineering-specific pharmacological binding sites for peptidyl inhibitors of potassium channels into KcsA. *Biochemistry* **41**: 15369-15375
- Legros C, Célérier ML, Henry M, Guette C (2004) Nanospray analysis of the venom of the tarantula *Theraphosa leblondi*: a powerful method for direct venom mass fingerprinting and toxin sequencing. *Rapid Commun Mass Spectrom* **18**: 1024-1032
- Legros C, Martin-Eauclaire MF, Pongs O, Bougis PE (2007) Toxin binding to chimeric K<sup>+</sup> channels immobilised on a solid nitrocellulose support. *Biochem Biophys Res Commun* **353**: 1086-1090
- Legros C, Guette C, Martin-Eauclaire MF, Goyffon M, Tortajada J (2009) Affinity capture using chimeric membrane proteins bound to magnetic beads for rapid ligand screening by matrix-assisted laser desorption/ionization time-of-flight mass spectrometry. *Rapid Commun Mass Spectrom* **23**: 745-755
- MacKinnon R, Cohen SL, Kuo A, Lee A, Chait BT (1998) Structural conservation in prokaryotic and eukaryotic potassium channels. *Science* **280**: 106-109
- Miller C (1995) The charybdotoxin family of K<sup>+</sup> channel-blocking peptides. *Neuron* **15**: 5-10
- Pongs O, Legros C (2000) Pharmacology of voltage-gated potassium channels. In *Handbook of Experimental Pharmacology*, Endo M, Mishina M (eds) Vol 147, Chap 7, pp 177-196. Berlin Heidelberg: Springer-Verlag
- Schrempf H, Schmidt O, Kummerlen R, Hinnah S, Muller D, Betzler M, Steinkamp T, Wagner R (1995) A prokaryotic potassium ion channel with two predicted transmembrane segments from *Streptomyces lividans*. *Embo J* **14**: 5170-5178
- Swartz KJ (2007) Tarantula toxins interacting with voltage sensors in potassium channels. *Toxicon* **49**: 213-230
- Uysal S, Vásquez V, Tereshko V, Esaki K, Fellouse FA, Sidhu SS, Koide S, Perozo E, Kossiakoff A (2009) Crystal structure of full-length KcsA in its closed conformation. *Proc Natl Acad Sci USA* **106**: 6644-6649
- Wolters M, Madeja M, Farrell AM, Pongs O (1999) *Bacillus stearothermophilus* *lctB* gene gives rise to functional K<sup>+</sup> channels in *Escherichia coli* and in *Xenopus* oocytes. *Receptors Channels* **6**: 477-491
- Zhou YF, Morais-Cabral JH, Kaufman A, MacKinnon R (2001) Chemistry of ion coordination and hydration revealed by a K<sup>+</sup> channel-Fab complex at 2.0 Å resolution. *Nature* **414**: 43-48

## **HTRF<sup>®</sup> et Tag-lite<sup>®</sup>, de nouvelles technologies de fluorescence permettant l'étude d'évènements moléculaires**

Eric TRINQUET

Cisbio Bioassays, Parc Technologique Marcel Boiteux, B.P. 84175, F-30204 Bagnols/Cèze cedex, France  
Courriel : [etrinquet@cisbio.com](mailto:etrinquet@cisbio.com)

---

### **Résumé**

Parmi les techniques permettant d'étudier les interactions entre biomolécules, la technologie HTRF (pour « Homogeneous Time Resolved Fluorescence ») s'est rapidement imposée comme une technologie de référence dans le domaine du criblage à haut débit. En associant une modulation du signal de l'essai basée sur un transfert d'énergie non radiatif de fluorescence (FRET) avec une détection de fluorescence en temps résolu, la technologie HTRF permet une miniaturisation et une automatisation simples de tests présentant une grande sensibilité. Elle a été appliquée avec succès dans de nombreux essais biochimiques ou cellulaires. La combinaison d'HTRF à des technologies de marquage basées sur des enzymes suicide a permis le développement d'une nouvelle plateforme d'essais cellulaires appelée Tag-lite. Cette plateforme permet à la fois des études mécanistiques et fonctionnelles d'un récepteur d'intérêt. Jusqu'à cinq tests différents peuvent être menés en parallèle sur une seule lignée cellulaire dans un format compatible avec le haut débit. Grâce à cela, Tag-lite permet une caractérisation en profondeur de nouvelles molécules ciblant ces récepteurs : des informations sur le mode de liaison ainsi que sur leur action sur les différentes voies de signalisation cellulaires peuvent être obtenues dans des formats d'essais à haut débit.

### **HTRF<sup>®</sup> and Tag-lite<sup>®</sup>, new fluorescent technologies to monitor biomolecular events**

Many different technological approaches have been used during the last decade to investigate biomolecular events. Among them, the Homogeneous Time Resolved Fluorescence (HTRF) technology is considered to be a reference technique to carry out screening campaigns in a high-throughput environment. Here homogeneous refers to a wash-free procedure. By associating signal modulation through fluorescence resonance energy transfer (FRET) with a time-resolved detection, HTRF allows both a reliable automation and a strong miniaturization of sensitive assays. It has been successfully applied in biochemical assays as well as in cell-based assays to monitor a large range of biomolecular events. By combining the HTRF detection with labeling technologies based on suicide enzymes, a new fluorescent cell-based assay platform called Tag-lite has been designed. It allows both mechanistic and functional studies of an N-terminally fused receptor of interest. Up to five different cell-based assays including dimerization, binding or functional assays can be established on a single cell line in a high-throughput screening compatible format. Tag-lite allows us to characterize compounds targeting these receptors and to better understand their mechanisms of actions. Key information about their binding mode, their effects on various signaling pathways, and features of membrane organization features can be obtained in a HTS compatible format.

**Keywords :** Drug screening, FRET, HTRF, molecular interactions, Tag-lite.

---

## **Introduction**

Ces dernières années, l'industrie pharmaceutique a multiplié ses efforts de recherche afin d'identifier de nouvelles molécules capables de réguler efficacement les mécanismes moléculaires et cellulaires impliqués dans les pathologies. Ces efforts ont notamment abouti à la mise en place de tests de criblages à haut débit dans lesquels des centaines de milliers de molécules sont testés sur une cible biologique, le but de ces cribles de masse étant de détecter des molécules originales. Pour répondre aux contraintes d'automatisation et de miniaturisation posées par ces criblages, des techniques de détection non radioactive et homogènes, c'est-à-dire ne requérant pas d'étapes de lavages ou de séparation, ont été mises au point durant les deux dernières décennies.

Parmi les techniques disponibles, la technologie HTRF (*Homogeneous Time Resolved Fluorescence*) s'est rapidement imposée comme une technique de référence alliant une excellente robustesse à de grosses



capacités de miniaturisation. Dans une première partie, cet article détaillera les principes biophysiques de cette technologie et illustrera son utilisation, tant dans des tests biochimiques que dans des essais cellulaires.

Depuis 2009, la technologie HTRF a été combinée à des technologies de marquage basées sur des enzymes suicides pour donner naissance à une plateforme d'étude de récepteurs à la surface cellulaire. Cette plateforme, appelée Tag-lite, permet de réaliser une étude multidimensionnelle d'un récepteur d'intérêt à partir d'une seule lignée cellulaire exprimant ce récepteur. La seconde partie de cet article décrira la plateforme Tag-lite ainsi que les tests cellulaires qu'elle permet de réaliser.

## La technologie HTRF

La technologie HTRF est basée sur le principe du transfert d'énergie non-radiatif de fluorescence (FRET) entre un donneur et un accepteur de fluorescence énergétiquement compatibles (Figure 1A; Selvin *et al.*, 2000). Ce phénomène de FRET se produira lorsque le donneur et l'accepteur seront séparés par une distance inférieure à 10 nm. Plus cette distance sera courte, plus le FRET sera efficace (Figure 1B; Mathis, 1995). Comme l'illustre la Figure 1C, le FRET est aujourd'hui largement employé pour étudier des phénomènes biologiques, notamment les interactions entre biomolécules (Eidne *et al.*, 2002).

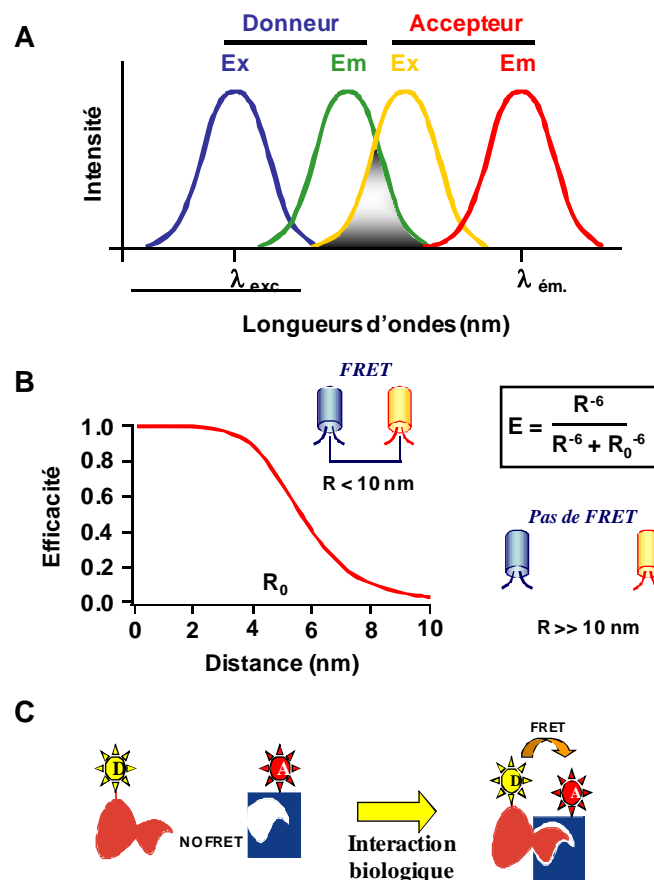

**Figure 1. Le FRET.** (A) Un FRET peut apparaître seulement si le spectre d'émission du donneur recouvre le spectre d'excitation de l'accepteur. Ce recouvrement est défini par une intégrale de recouvrement  $J$ . (B) Un FRET est observé si la distance séparant les deux fluorophores est inférieure à 1,8 x le rayon de Förster ( $R_0$ ). Ce dernier définit la distance donneur – accepteur pour laquelle l'efficacité du transfert d'énergie est de 50%. (C) Un FRET peut résulter de l'interaction biologique entre deux protéines respectivement marquées avec un donneur (D) et un accepteur (A).

**Figure 1. FRET principles.** (A) FRET only occurs if the excitation spectrum of the acceptor overlaps the donor emission spectrum. Overlapping is defined by an integral overlap  $J$ . (B) FRET can be observed when the distance between the donor and the acceptor is below 1.8 x Förster's radius ( $R_0$ ). Förster's radius is the distance between donor and acceptor for which the FRET efficacy is 50%. (C) FRET can occur upon the biological interaction between 2 proteins labeled with a donor and an acceptor, respectively.

Toutefois, la sensibilité du FRET limite ses applications en biologie cellulaire. Les donneurs et les accepteurs utilisés, généralement des mutants de la *Green Fluorescent Protein* (GFP), donnent un faible signal/bruit qui s'ajoute à un problème d'auto-fluorescence cellulaire lorsque l'échantillon est excité à 488 nm (Trinquet et Mathis, 2006). Dans la technologie HTRF, l'utilisation de donneurs, les cryptates de terre rare (europium ou terbium), possédant des durées de vie de fluorescence beaucoup plus longues que celle des sondes

fluorescentes classiques (entre 1 à 2 millisecondes contre quelques nanosecondes pour les sondes standards), permet de mettre en œuvre une détection du signal de FRET en temps résolu. Ce mode de détection permet de s'affranchir des fluorescences parasites induites notamment par les cellules ou les milieux biologiques (Trinquet et Mathis, 2006).

Dans la technologie HTRF, l'émission de fluorescence de l'accepteur à 665 nm due au FRET sera normalisée par l'émission de fluorescence à 620 nm du donneur, le cryptate d'europlum ou de terbium. Cette normalisation du signal permet de s'affranchir des variations optiques induites par les milieux biologiques. Dès lors, la valeur de ce rapport ne dépendra que des interactions biologiques (Figure 2).

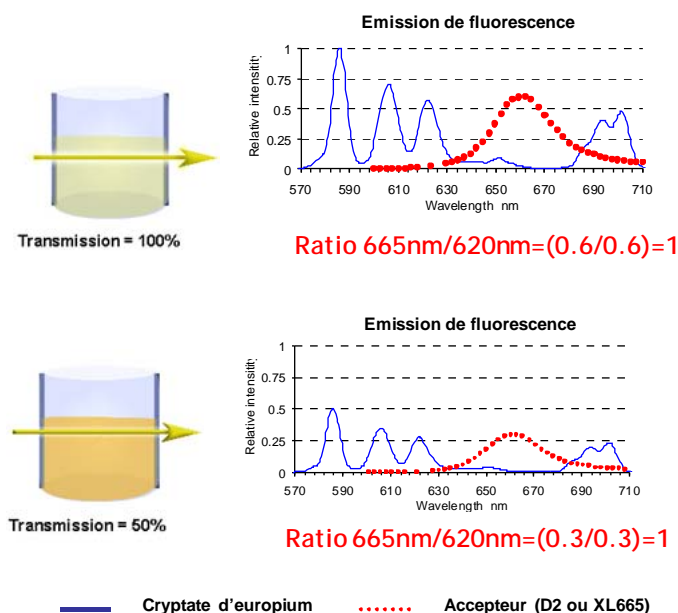

**Figure 2.** L'utilisation d'un rapport de signaux de fluorescence dans la technologie HTRF. Le rapport entre le signal de fluorescence de l'accepteur induit par le FRET qui est émis à 665 nm et le signal de fluorescence émis par le donneur à 620 nm permet de s'affranchir des variations optiques pouvant exister entre différents milieux.

**Figure 2.** The ratio between the acceptor signal at 665 nm coming from the FRET and the donor signal at 620 nm allows correcting the FRET signal from sample to sample optical variations.

La robustesse de ce rapport permet d'analyser le FRET dans des milieux biologiques complexes et de tester des bibliothèques dont les composés peuvent présenter de fortes absorbances.

Dans la technologie HTRF, l'apparition d'un signal étant liée à la modulation de la distance entre le donneur et l'accepteur, celle-ci ne nécessite aucune étape de lavage dans sa mise en œuvre (technologie homogène). Elle peut dès lors être facilement miniaturisée et robotisée.

Grâce à sa sensibilité, sa grande robustesse et à sa capacité de miniaturisation (jusqu'à un format de plaque 1536 puits), HTRF est aujourd'hui devenue une référence dans le domaine du criblage à haut débit.

Elle a été appliquée avec succès dans la mise en place d'essais biochimiques basés sur des peptides, des protéines recombinantes ou des oligonucléotides (Bazin *et al.*, 2002). Elle a permis notamment d'identifier des composés régulant des interactions protéine-protéine (Kane, 2000), des réactions enzymatiques telles que des phosphorylations (Jia, 2006) ou des poly-ubiquitinations (Yabuki *et al.*, 1999).

La technologie HTRF a aussi trouvée de nombreuses applications dans des tests cellulaires au travers d'immunoessais détectant soit la sécrétion de cytokines (Achar *et al.*, 2003) soit l'accumulation intracellulaire de seconds messagers (cAMP ou IP1) suite à l'activation de Récepteurs Couplés aux Protéines G (RCPG) par des ligands (Trinquet *et al.*, 2006; Gabriel *et al.*, 2003).

## La technologie Tag-lite

Afin d'étendre le champ d'application de la technologie HTRF, celle-ci a été combinée à des technologies de marquage à base d'enzymes suicides, les technologies SNAP-tag<sup>®</sup>, CLIP-tag<sup>®</sup> ou HALO-tag<sup>®</sup>, afin de créer une plateforme d'étude des récepteurs à la surface de cellules vivantes. Cette plateforme permet de réaliser différents tests cellulaires à partir d'une seule lignée exprimant un récepteur d'intérêt.

### Les technologies de marquage à base d'enzymes suicides

La fusion de protéines d'intérêt à des enzymes suicides (SNAP-tag, CLIP-tag, ou HALO-tag) permet leur marquage covalent par des sondes fluorescentes. En effet, chaque enzyme réagit de manière covalente et

irréversible avec un substrat spécifique préalablement substitué par une sonde fluorescente. Lors de la réaction enzyme/substrat, la sonde fluorescente sera transférée sur l'enzyme permettant ainsi un marquage sélectif de la protéine à laquelle elle a été fusionnée. Selon les applications Tag-lite envisagées (tests de dimérisation, de liaison ou d'internalisation), ce marquage sélectif sera réalisé avec des substrats portant le cryptate de terbium (tests de liaison ou d'internalisation) ou par des mélanges de substrats donneurs et accepteurs (tests de dimérisation).

Les technologies SNAP-tag et CLIP-tag utilisent des enzymes suicides dérivées de l'O<sup>6</sup>-alkylguanine DNA alkyltransferase (AGT; Juillerat *et al.*, 2003). Elles ont la capacité de fixer de manière covalente dans leur site catalytique des groupements benzyl substitués par des sondes fluorescentes provenant soit d'un O<sup>6</sup>-benzylguanine fluorescent pour SNAP-tag (Keppler *et al.*, 2003) soit d'un O<sup>2</sup>-benzylcytosine fluorescent pour le CLIP-tag.

La technologie HALO-tag utilise quant à elle une enzyme dérivée d'une déhalogénase de 33 kDa provenant d'une bactérie *Rhodococcus rhodochrous* qui utilise les chloroalcanes comme source de carbone et d'énergie. Le chloroalcanes, substrat de l'Halo-tag peut être facilement dérivatisé par différentes sondes fluorescentes qui, après réaction enzymatique, seront couplées de manière covalente à l'enzyme.

Dans l'optique de combiner ces technologies de marquage avec HTRF pour étudier des récepteurs exprimés à la surface cellulaire, des substrats fluorescents spécifiques ont été développés. Ils intègrent des sondes fluorescentes compatibles avec HTRF, les cryptates de terbium, des accepteurs verts ou proche infrarouge. Ces substrats ont été chimiquement optimisés afin d'être:

- non-perméants pour ne marquer que les récepteurs exprimés à la surface cellulaire,
- très réactifs pour obtenir un marquage optimal des récepteurs avec un minimum de substrat.

La *Figure 3* illustre le principe de marquage des récepteurs avec les substrats fluorescents compatibles avec HTRF.

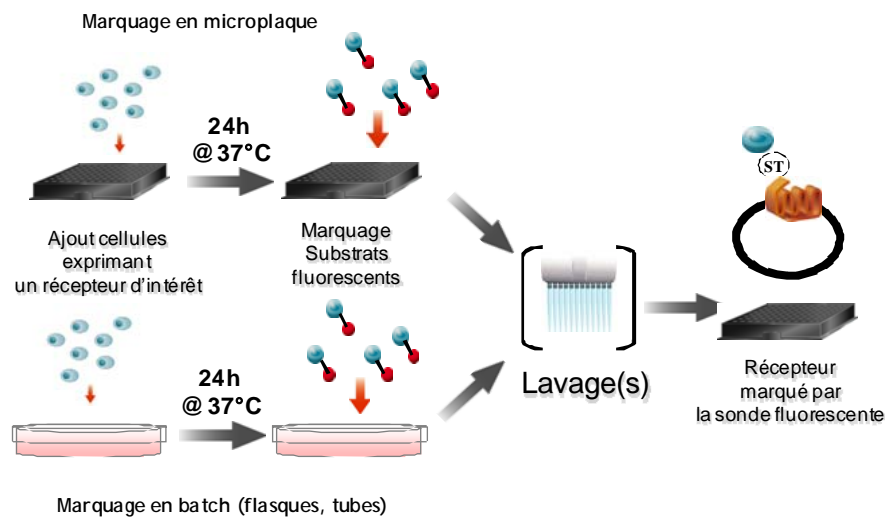

**Figure 3.** Marquage des récepteurs par des substrats fluorescents à la surface cellulaire.

*Figure 3.* Cell surface receptor labeling by fluorescent substrates.

Les études menées sur le récepteur GABA<sub>B</sub> (Maurel *et al.*, 2008) ou sur les récepteurs métabotropiques au glutamate (Doumazane *et al.*, 2010) ont montré que cette technique de marquage permet d'obtenir 100% de marquage d'un récepteur à la surface de cellules vivantes.

En combinant HTRF avec ces techniques de marquage à base d'enzymes suicides, la plateforme Tag-lite permet la mise en œuvre de différents tests cellulaires:

- Mise en évidence de la dimérisation et de l'oligomérisation des récepteurs.
- Des tests de liaison non radioactifs.
- Des tests fonctionnels.

### Mise en évidence de la dimérisation et de l'oligomérisation de récepteurs

Les *Figures 4* et *5* illustrent l'application de la technologie Tag-lite à l'étude de l'organisation de récepteurs à la surface de cellules vivantes grâce à l'utilisation de mélanges de substrats donneurs et accepteurs des enzymes SNAP-tag et/ou CLIP-tag pour réaliser le marquage des récepteurs d'intérêt.

L'utilisation de substrats fluorescents non-perméants permet une étude spécifique des récepteurs à la surface des cellules. Ce type d'étude s'avère impossible avec les autres techniques connues, comme le FRET basé sur des mutants de GFP ou le BRET (Mercier *et al.*, 2002). Celles-ci ne peuvent pas discriminer une dimérisation intracellulaire d'une dimérisation se produisant uniquement à la surface cellulaire.

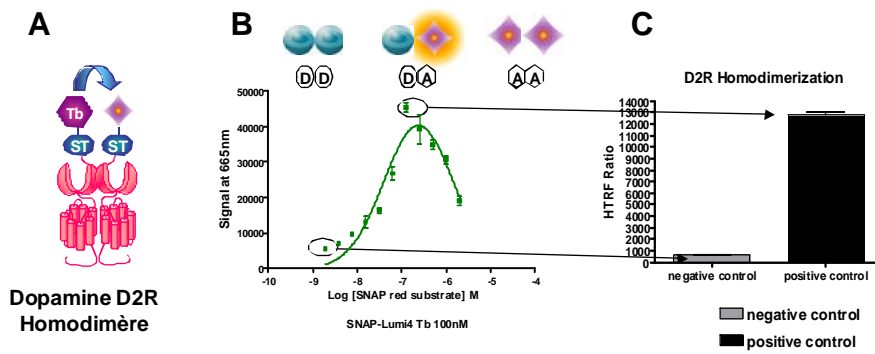

**Figure 4. Principe de la détection d'homodimères de récepteurs avec Tag-lite.** (A) Schéma de détection de l'homodimère du récepteur Dopamine D2. (B) L'enzyme de marquage étant la même pour les 2 récepteurs, il faut déterminer la stœchiométrie optimale entre le substrat donneur et le substrat accepteur pour avoir 50% des récepteurs marqués avec un donneur et un accepteur (signal de FRET à 665 nm maximum). Pour cela on fixe la concentration du substrat donneur à 100 nm et l'on ajoute des doses croissantes de substrat accepteur. (C) Valeur du ratio HTRF pour la stœchiométrie optimale entre les substrats (positive control) et pour le contrôle sans FRET (negative control).

**Figure 4. Detection of receptors homodimerization using Tag-lite.** (A) Scheme of the detection of the dopamine D2 homodimer. (B) Determination of the optimal stoichiometry between acceptor and donor substrates to achieve a 50% labeling of the total number of D2 receptor (maximum of FRET signal at 665 nm). For that purpose, a fixed concentration of donor substrate is mixed with increasing concentration of acceptor substrate. (C) HTRF ratio obtained with the optimal stoichiometry between the fluorescent substrates for a positive and a negative control.

Grâce à Tag-lite, des avancées majeures dans la connaissance de l'organisation de certains récepteurs ont été réalisées. C'est notamment le cas pour les RCPG de classe C comme les récepteurs métabotropiques au glutamate (mGluRs) ou le récepteur GABA<sub>B</sub>. Leur étude, réalisée avec Tag-lite, a permis de montrer que les mGluRs sont des dimères stricts (Rives *et al.*, 2009) tandis que le récepteur GABA<sub>B</sub> est un tétramère à la surface cellulaire (Maurel *et al.*, 2008). Plus récemment, Doumazane *et al.* (2010) a démontré que les mGluRs pouvaient non seulement s'associer sous forme d'homodimères mais aussi sous forme d'hétérodimères.

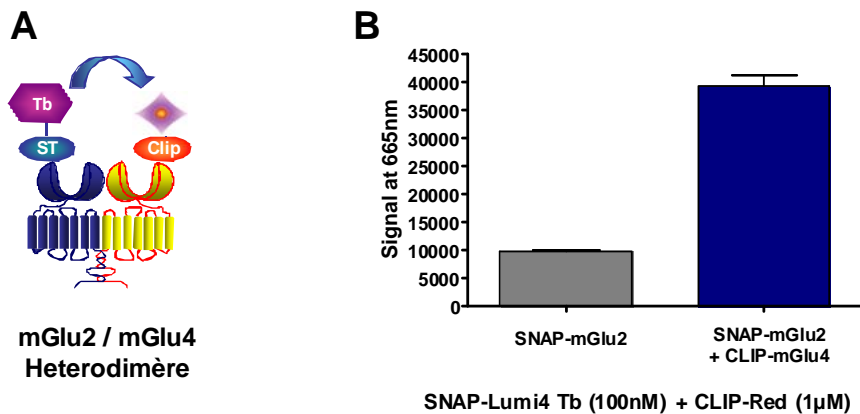

**Figure 5. Principe de la détection d'hétérodimères de récepteurs avec Tag-lite.** (A) Schéma de détection de l'hétérodimère mGlu2/mGlu4. (B) L'enzyme de marquage étant différente entre les 2 récepteurs, 100% des hétérodimères peuvent être détectés en ajoutant simultanément sur les cellules exprimant les récepteurs des doses saturantes du substrat donneur SNAP-tag (SNAP-Lumi4 Tb 100 nm) et du substrat accepteur (CLIP-Red 1µM). Le signal de FRET est ensuite détecté en présence (SNAP-mGlu2+CLIP-mGlu4) ou en absence (SNAP-mGlu2) d'hétérodimère.

**Figure 5. Detection of receptors heterodimerization using Tag-lite.** (A) Detection scheme of the mGlu2/mGlu4 heterodimer. (B) Since the suicide enzyme used is different from one receptor to the other, 100% of the receptors heterodimers can be detected following the simultaneous addition on cells of both the donor-labeled SNAP-tag substrate (SNAP-Lumi4 Tb 100 nm) and the acceptor-labeled substrate (CLIP-Red 1µM). FRET signal is detected in presence (SNAP-mGlu2+CLIP-mGlu4) or in absence (SNAP-mGlu2) of receptor heterodimer.

### Des tests de liaison non radioactifs

La fusion d'une enzyme suicide en N-terminal d'un récepteur n'affecte généralement pas sa capacité à lier un ligand, qu'il soit un agoniste ou un antagoniste du récepteur d'intérêt. Cela a été démontré pour la première fois sur le récepteur GABA<sub>B</sub> (Maurel *et al.*, 2008) et a depuis été confirmé pour d'autres RCPG (Leyris *et al.*,

2010) ainsi que pour des récepteurs à domaine tyrosine kinase (RTK). Il est alors possible de mettre en œuvre des tests de liaison non radioactifs en un récepteur marqué de manière covalente par un cryptate de terbium (donneur) et un ligand marqué avec un accepteur (Figure 6A,B). L'étude de composés pouvant lier le récepteur d'intérêt est réalisée par un test de compétition entre le ligand fluorescent et le composé non marqué: si ce dernier lie le récepteur, il va faire disparaître le signal de FRET (Figure 6C).

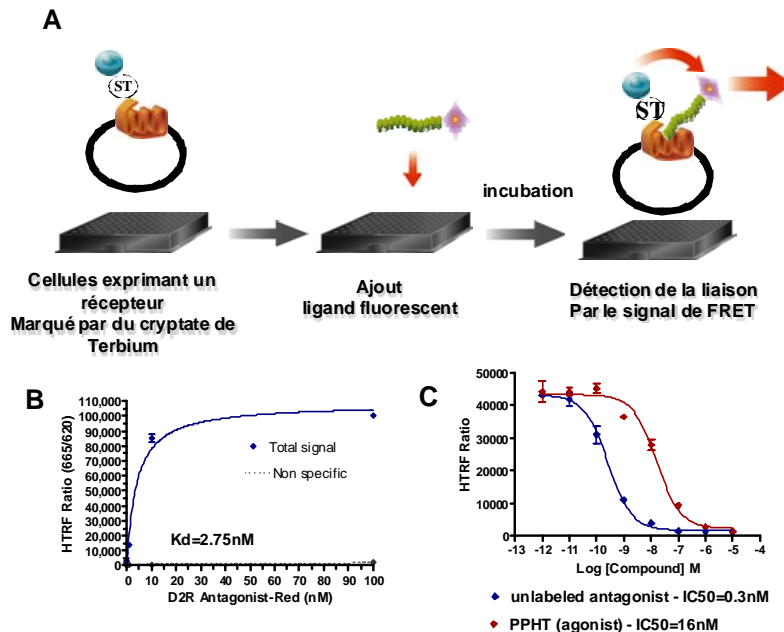

**Figure 6. Test de liaison.** (A) Principe du test. (B) Mesure de l'affinité d'un antagoniste fluorescent du récepteur Dopamine D2 (D2R). Le signal total est obtenu en ajoutant des doses croissantes (0 à 100 nM) de ligand fluorescent sur des cellules exprimant le D2R. Le signal non spécifique est obtenu en ajoutant sur les cellules les mêmes doses de croissantes de ligand fluorescentes associées à un excès de ligand non marqué (2  $\mu$ M). (C) Test par compétition de composés non marqués. Des doses croissantes de composés non marqués sont mélangées à une concentration fixe de traceur fluorescent (3 nM) puis ajoutées sur des cellules exprimant le D2R. Le déplacement du ligand fluorescent par les composés non marqués provoque une extinction progressive du signal du FRET.

**Figure 6. Ligand binding assay.** (A) Test principle. (B) Determination of the affinity of a fluorescent antagonist on the Dopamine D2 receptor (D2R). Total signal is obtained by adding increasing concentrations of the fluorescent antagonist (0 to 100 nM) on cells expressing D2R. Non specific signal is obtained by mixing the same concentrations of the fluorescent antagonist with an excess of cold ligand (2  $\mu$ M). (C) Competition assays using non labelled compounds. Increasing concentrations of compounds are mixed with a fixed concentration of fluorescent ligand (3 nM) and then added on the labelled cells. The displacement of the fluorescent ligand by the compounds induces a progressive decrease of the FRET signal.

Cette technique est une alternative très simple aux techniques radioactives coûteuses et lourdes à réaliser. Elle nécessite toutefois de disposer de ligands fluorescents spécifiques possédant une bonne affinité pour les récepteurs à étudier. A ce jour, plus de 30 ligands fluorescents de différentes natures (petites molécules, peptides ou protéines) ont été validés sur des RCPG ou sur des RTK. Une étude récente sur le récepteur de la ghréline humaine (GHSR1a), montre que les résultats obtenus avec la technologie Tag-lite sont très bien corrélés avec ceux d'une technologie radioactive de référence (Leyris *et al.*, 2010).

Ces tests de liaison peuvent aussi être rendus facilement compatibles avec le très haut débit grâce à l'utilisation de cellules congelées dont les récepteurs ont été marqués préalablement au cryptate de terbium. Après décongélation, ces cellules sont distribuées dans les plaques en même temps que les ligands fluorescents et les composés à tester. Cela simplifie considérablement la mise en œuvre du test et facilite sa robotisation (Zwier *et al.*, 2010).

### Les tests fonctionnels

La Figure 7 montre que la fusion d'une enzyme suicide en N-terminal d'un RCPG n'affecte pas sa capacité d'induire une signalisation intracellulaire similaire à celui d'un récepteur sauvage et ce quel que soit sa classe. Ces résultats confirment ceux publiés par Maurel *et al.* (2008), Leyris *et al.* (2010) et Doumazane *et al.* (2010). Des données préliminaires indiquent aussi que la signalisation de RTK n'est pas affectée par la fusion du SNAP-tag au N-terminal de ces récepteurs. Dès lors, l'étude de l'activation de tels récepteurs reste possible en utilisant les kits HTRF de dosage de second messagers cellulaires cAMP et IP-One (activation des protéines G, Gs, Gi ou Gq) ou de kits permettant la détection de la phosphorylation des protéines ERK, AKT ou STAT.

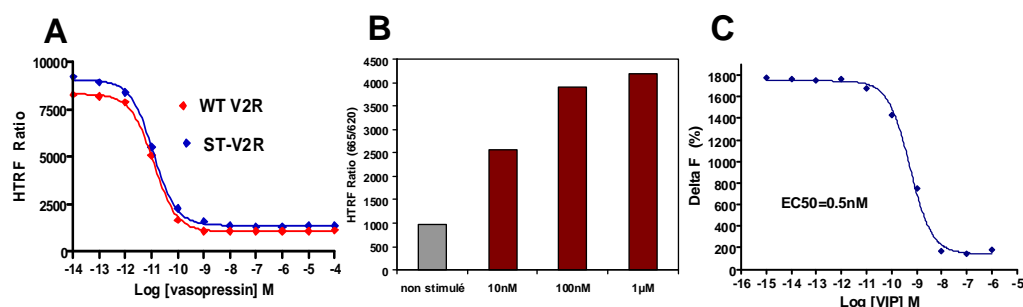

**Figure 7. Signalisation de GPCR fusionnés en N-terminal avec l'enzyme SNAP-Tag.** (A) Détection de la production intracellulaire de cAMP (kit HTRF cAMP) suite à la stimulation du récepteur de classe A vasopressine V2 fusionné (ST-V2R) ou non (WT-V2R) à l'enzyme SNAP-Tag. (B) Phosphorylation de la protéine ERK induite par la stimulation du récepteur de classe A MC4 par différentes concentrations de NDP-alpha-MSH (kit Cellul'Erk). (C) Détection de la production intracellulaire de cAMP (kit HTRF cAMP) suite à la stimulation du récepteur de classe B VPAC1 fusionné à l'enzyme SNAP-Tag.

**Figure 7. Signalling of GPCR fused in N-terminus with the SNAP-Tag enzyme.** (A) Detection of the intracellular production of cAMP (HTRF cAMP kit) upon stimulation of the class A vasopressin V2 receptor fused (ST-V2R) or not (WT-V2R) to the SNAP-Tag enzyme. (B) ERK phosphorylation upon stimulation of the MC4 receptor (class A) fused to the SNAP-tag by increasing concentrations of NDP-alpha-MSH (Cellul'Erk kit). (C) Detection of the intracellular accumulation of cAMP upon stimulation of the VPAC1 receptor (class B) fused to the SNAP-Tag enzyme.

En complément de ces tests fonctionnels, le marquage fluorescent des récepteurs a permis la mise en œuvre d'un nouveau test permettant d'étudier l'internalisation d'un récepteur suite à son activation par un agoniste. Comme l'illustre la *Figure 8*, ce phénomène de régulation de l'expression du récepteur à la surface cellulaire est détecté grâce à la disparition d'un FRET dynamique se produisant entre un donneur lié au récepteur et un accepteur diffusant librement dans le milieu extracellulaire.

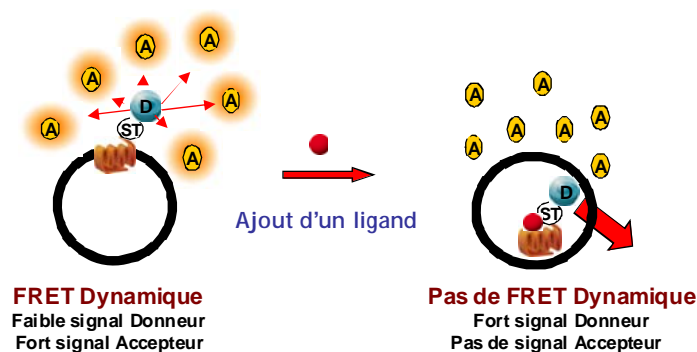

**Figure 8. Détection de l'internalisation d'un récepteur par FRET dynamique.** Le récepteur d'intérêt est marqué via l'enzyme SNAP-Tag par un cryptate de terbium (Donneur D). Une forte concentration (>10 μM) d'accepteur non perméant (A) est ajoutée dans le milieu extracellulaire. La diffusion rapide de celui-ci dans le milieu extracellulaire va créer un très fort signal de FRET dynamique. L'ajout d'un ligand provoquant l'internalisation du récepteur va supprimer ce signal de FRET dynamique provoquant une disparition du signal Accepteur et une forte augmentation du signal donneur.

**Figure 8. Detection of the receptor internalization using dynamic FRET.** The receptor of interest is labeled with terbium cryptate through the SNAP-tag enzyme (Donor D). A large concentration (>10 μM) of a non-permeant acceptor (A) is then added into the extracellular medium. Its fast diffusion into the medium induces a strong dynamic FRET. Upon ligand addition, the receptor internalization will suppress the dynamic FRET inducing both a decrease of the acceptor signal and an increase of the donor signal.

La preuve de concept de ce test d'internalisation a été réalisée sur le récepteur à la vasopressine V2 (V2R) transfecté de manière transitoire dans des cellules COS7. Les résultats obtenus montrent que la méthode est quantitative, facilement automatisable et miniaturisable grâce à l'absence d'étapes de lavages (*Figure 9*).

#### Tag-lite permet une étude multidimensionnelle d'un récepteur d'intérêt

La plateforme Tag-lite permet, sur des cellules vivantes exprimant un récepteur d'intérêt, de réaliser en parallèle différents tests permettant à la fois de connaître l'organisation du récepteur à la surface cellulaire, d'identifier ses ligands spécifiques et d'étudier les différentes voies de signalisation médiées par ce récepteur. Sa compatibilité avec de nombreuses familles de récepteurs et son format haut débit offrent aux chercheurs un puissant outil d'étude multidimensionnel leur permettant d'appréhender des concepts tels que la régulation des mécanismes de dimérisation des récepteurs, l'impact de cette dimérisation sur leur pharmacologie ou l'identification de ligands « biaisés » capables de moduler de façon différentielle les voies de signalisation d'un récepteur.

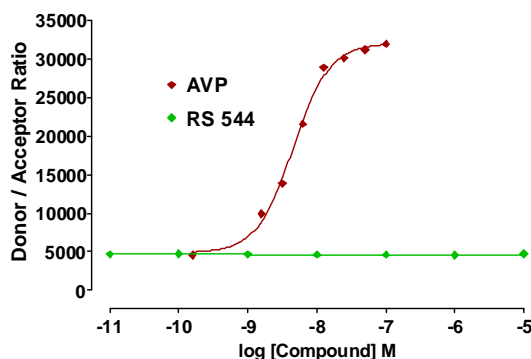

**Figure 9. Etude de l'internalisation du récepteur V2R.** L'arginine-vasopressine (AVP), un agoniste du V2R, provoque une internalisation dose dépendante du V2R tandis qu'un antagoniste peptidique du même récepteur, le RS544, n'induit aucune internalisation.

**Figure 9. Study of the V2R internalization.** Arginin-vasopressin (AVP), a V2R agonist, induces a dose dependant internalization of the receptor while a V2R peptidic antagonist, RS544, does not.

## Références

- Achard S, Jean A, Lorphelin D, Amoravain M, Claret E (2003) Homogeneous assays allow direct "in well" cytokine level quantification. *Assay Drug Dev Technol* **1**: 181-185
- Bazin H, Trinquet E, Mathis G (2002) Time resolved amplification of cryptate emission: a versatile technology to trace biomolecular interactions. *Rev Mol Biotechnol* **82**: 233-250
- Doumazane E, Scholler P, Zwier J, Trinquet E, Rondard P, Pin JP (2010) A new approach to analyze cell surface protein complexes reveals specific heterodimeric metabotropic glutamate receptors. *FASEB J in press* (doi: 10.1096/fj.10-163147)
- Eidne K, Karen M, Kroeger K, Hanyaloglu A (2002) Applications of novel resonance energy transfer techniques to study dynamic hormone receptor interactions in living cells. *Trends Endocrinol Metab* **13**: 415-421
- Gabriel D, Vernier M, Pfeifer MJ, Dasen B, Tenailon L, Bouhelal R (2003) High throughput screening technologies for direct cyclic AMP measurement. *Assay Drug Dev Technol* **1**: 291-303
- Jia Y, M. Quinn CM, Clabbers A, Talanian R, Xu Y, Wishart N, Allen H (2006) Comparative analysis of various *in vitro* COT kinase assay formats and their applications in inhibitor identification and characterization. *Anal Biochem* **350**: 268-276
- Juillat A, Gronemeyer T, Keppler A, Gendrezig S, Pick H, Vogel H, Johnsson K (2003) Directed evolution of O6-alkylguanine-DNA alkyltransferase for efficient labelling of fusion proteins with small molecules *in vivo*. *Chem Biol* **10**: 313-317
- Kane SA, Fleener CA, Zhang YS, Davis LJ, Musselman AL, Huang PS (2000) Development of a binding assay for p53/HDM2 by using time-resolved fluorescence. *Anal Biochem* **278**: 29-38
- Keppler A, Gendrezig S, Gronemeyer T, Pick H, Vogel H, Johnsson K (2003) A general method for the covalent labelling of fusion proteins with small molecules *in vivo*. *Nature Biotechnol* **21**: 86-89
- Leyris JP, Roux T, Trinquet E, Verdié P, Fehrentz JA, Oueslati N, Douzon S, Bourrier E, Lamarque L, Gagne D, Galleyrand JC, M'kadmi C, Martinez J, Mary S, Banères JL, Marie J (2010) Homogeneous time-resolved fluorescence-based assay to screen for ligands targeting the ghrelin receptor growth hormone secretagogue receptor type 1a (GHS-R1a). *Anal Biochem in press* (doi:10.1016/j.ab.2010.09.030)
- Mathis G (1995) Probing molecular interactions with homogeneous techniques based on rare earth cryptates and Fluorescence Energy Transfer. *Clin Chem* **41**: 1391-1397
- Maurel D, Comps-Agrar L, Brock C, Rives ML, Bourrier E, Ayoub MA, Bazin H, Tinel N, Durroux T, Prézeau L, Trinquet E, Pin JP (2008) Cell-surface protein interaction analysis with time-resolved FRET and snap-tag technologies: application to GPCR oligomerization. *Nat Methods* **5**: 561-567
- Mercier J.F, Salahpour A, Angers S, Breit A, Bouvier M (2002) Quantitative assessment of  $\beta 1$  and  $\beta 2$ adrenergic receptor homo- and heterodimerization by bioluminescence resonance energy transfer. *J Biol Chem* **277**: 44925-44931
- Rives ML, Vol C, Fukazawa Y, Tinel N, Trinquet E, Ayoub MA, Shigemoto R, Pin JP, Prézeau L (2009) Crosstalk between GABA(B) and mGlu1a receptors reveals new insight into GPCR signal integration. *EMBO J* **28**: 2195-2208
- Selvin PR (2000) The renaissance of fluorescence resonance energy transfer. *Nat Struct Biol* **7**: 730-734
- Trinquet E, Mathis G. (2006) Fluorescence technologies for the investigation of chemical libraries. *Mol Biosyst* **2**: 380-387
- Trinquet E, Fink M, Bazin H, Grillet F, Maurin F, Bourrier E, Ansanay H, Leroy C, Michaud A, Durroux T, Maurel D, Malhaire F, Goudet C, Pin JP, Naval M, Hernout O, Chrétien F, Chapleur Y, Mathis G (2006) D-myo-inositol 1-phosphate as a surrogate of D-myo-inositol 1,4,5-tris phosphate to monitor G protein-coupled receptor activation. *Anal Biochem* **358**: 126-135
- Yabuki N, Watanabe S, Kudo T, Nihira S, Miyamoto C (1999) Application of homogeneous time-resolved fluorescence (HTRF) to monitor poly-ubiquitination of wild-type p53. *Comb Chem High Throughput Screen* **2**: 279-287
- Zwier J, Roux T, Cottet M, Durroux T, Douzon S, Bdioui S, Gregor N, Bourrier E, Oueslati N, Nicolas L, Tinel N, Boisseau C, Yverneau P, Charrier-Savournin F, Fink M, Trinquet E (2010) A fluorescent ligand binding alternative using Tag-lite® technology. *J Biomol Screen in press*

## **Bio-inspired sensors based on the assembly of receptors and ion channels**

Lydia CARO, Christophe MOREAU, Jean REVILLOUD, Michel VIVAUDOU\*

Institut de Biologie Structurale (CEA, CNRS, Université Joseph Fourier), 41 rue Jules Horowitz, F-38027 Grenoble, France

\* Corresponding author ; Tel : +33 (0)4 3878 4867 ; Fax : +33 (0)4 3878 5494 ; E-mail : [vivaudou@ibs.fr](mailto:vivaudou@ibs.fr)

---

### **Abstract**

*Inspired by the natural example of  $K_{ATP}$  channels in which a "receptor" (SUR) directly modulates an ion channel (Kir6.2), we have developed the concept of ICCRs (Ion-Channel Coupled Receptors) where an ion channel is physically coupled to a G-protein coupled receptor (GPCR) and serves as a bioelectrical reporter of ligand binding to the receptor. The electrical nature of the signal permits direct interfacing to detection hardware and allows real-time detection of binding of unlabelled ligands with high signal/noise ratio in cells as well as cell-free conditions. ICCRs thus constitute new precision tools for the study of the interaction of ligands-natural modulators, drugs, toxins-with receptors.*

### **Des capteurs bio-inspirés construits par assemblage de récepteurs et canaux ioniques**

*Inspirés par l'exemple naturel des canaux  $K_{ATP}$ , dans lesquels un "récepteur" (SUR) module directement un canal ionique (Kir6.2), nous avons élaboré le concept d'ICCR (Ion-Channel Coupled Receptor) où un canal ionique est couplé physiquement à un récepteur couplé aux protéines G et sert de rapporteur bioélectrique de la liaison de ligand au récepteur. Le signal électrique produit est directement et facilement détectable, ce qui permet une mesure en temps réel de la liaison de ligands non-marqués avec un excellent rapport signal/bruit aussi bien dans un environnement cellulaire que dans des conditions acellulaires. Les ICCRs constituent ainsi de nouveaux outils de précision pour l'étude de l'interaction des ligands-modulateurs naturels, médicaments, toxines-avec les récepteurs.*

**Keywords** : Biosensor, channel, G protein-coupled receptor.

---

## **Introduction**

Using existing proteins as templates, it is possible to create biological objects with novel properties. Our recent publication (Moreau *et al.*, 2008) introduced Ion-Channel Coupled Receptors (ICCRs), hybrid proteins engineered by assembly of an ion channel and a receptor such that the ion channel serves as an electrical probe of the function of the attached receptor. The ICCR paradigm, conceived and developed over several years, is entirely novel and has many potential uses, from the most basic-the study of membrane protein interactions, receptor dynamics, and channel gating mechanisms-to the most applied-the design of versatile nanoelectronics biosensors for screening, diagnostics and biodetection.

## **Genesis of the ICCR concept**

The principle of ion-channel coupled receptor is illustrated in *Figure 1*: a receptor is joined with an ion channel to form an artificial ligand-gated channel. This idea of forming a functional channel from 2 unrelated membrane proteins originates from the natural organization of the ATP-sensitive  $K^+$  channel ( $K_{ATP}$ ), a physiologically and therapeutically-important ion channel that we have been studying for a number of years.

The ultrastructure of the  $K_{ATP}$  channel is unique among ion channels as it is a complex of two unrelated proteins: the sulfonylurea receptor (SUR), which is a member of the ABC (ATP-binding cassette) protein family, and a smaller protein Kir6.2 which belongs to the inward rectifier  $K^+$  channel family (*Figure 2*; Moreau *et al.*, 2005b; Nichols, 2006). In this channel, SUR and Kir6.2 are so tightly coupled that the Kir6.2 channel is a faithful reporter of the conformation of SUR. The conformational changes following ligand (substrate, nucleotide, drug) interaction are transferred to Kir6.2 and the resulting ion currents are detected with electrophysiological techniques. Indeed, we and others have extensively utilized the electrical signals generated by Kir6.2 to characterize the molecular properties of the otherwise silent SUR (Moreau *et al.*, 2000; Moreau *et al.*, 2005a) and try to understand the interactions between Kir6.2 and SUR (Hosy *et al.*, 2007; Dupuis *et al.*, 2008; Hosy *et al.*, 2010).



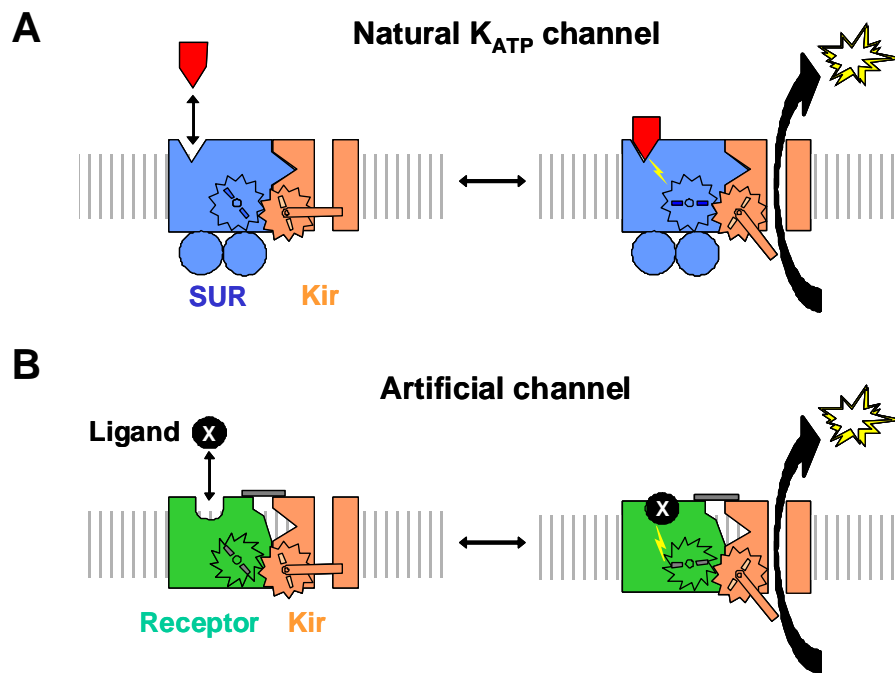

**Figure 1.** Principle of ICCR. **(A)** In natural  $K_{ATP}$  channels, the subunits SUR and Kir6.2 associate spontaneously and the binding of ligand to SUR triggers opening or closing of Kir6.2. **(B)** Mimicking natural channels, artificial channels may be envisioned where SUR is replaced by a receptor. Providing the receptor is engineered to couple to Kir6.2, these artificial channels could act as chemical-gated transistors with a very large gain (1 ligand-binding event =  $\sim 10^7$  ions/s through channel).

**Figure 1.** Le principe des ICCR. **(A)** Dans les canaux  $K_{ATP}$  naturels, les sous-unités SUR et Kir6.2 s'associent spontanément et la liaison de ligands à SUR déclenche l'ouverture ou la fermeture de Kir6.2. **(B)** Imitant des canaux naturels, des canaux artificiels peuvent être imaginés où SUR est remplacé par un récepteur. Si le récepteur est modifié pour favoriser son couplage à Kir6.2, ces canaux artificiels peuvent se comporter comme des transistors chimiques à très fort gain (1 événement de liaison de ligand =  $\sim 10^7$  ions/s au travers du canal).

Realizing the power of using a channel as a probe of an associated protein, we explored ways to mimic the  $K_{ATP}$  channel and create functional complexes between a channel and another membrane protein. As a channel, we chose to use Kir6.2, not only because it is part of the  $K_{ATP}$  channel, but also because it is a relatively simple, well-studied  $K^+$  channel that has the unique signature of being inhibited by intracellular ATP, a convenient feature that provides a straightforward means to identify the channel and control its open probability. As its partner, we started out with SUR homologues of the ABC family, such as the multidrug resistance transporters MRP1 and P-gp (unpublished work), and later moved to G-protein coupled receptors (GPCRs). GPCRs are of paramount importance in physiology and medicine. Although they bear no relation to SUR, they are also highly flexible proteins that undergo large conformational changes. It is interesting to note that, even though GPCRs interact with effectors via G-proteins, there is now increasing evidence that they can associate with ion channels. Modulatory physical interactions between an ion channel and a GPCR have been demonstrated for two pairs: D5 receptor/GABA<sub>A</sub> channel and D<sub>1</sub> receptor/NMDA channel (Liu *et al.*, 2000; Lee *et al.*, 2002).

### Engineering of Ion-Channel Coupled Receptors

We have built ICCRs using the Kir6.2 channel and 2 prototypical GPCRs, muscarinic M<sub>2</sub> and dopaminergic D<sub>2</sub>. In order to promote physical contacts between the 2 proteins, they were fused using variable-length linkers and tested by electrophysiological techniques in *Xenopus laevis* oocytes (Figure 2). Fusion was achieved by linking the C-terminal of the receptor and the N-terminal of the channel, which are both intracellular. Reasoning that protein extremities are often flexible and can dampen efficient transmission of physical forces, we performed limited deletions at both receptor and channel ends. Starting with M<sub>2</sub> receptor, by trial-and-error, we found conditions where ligand binding to the GPCR triggered a gating modification of the channel. The optimal coupling was achieved after removal of 25 residues from the channel C-terminal extremity. In the resulting construct M<sub>2</sub>-K<sub>0-25</sub>, M<sub>2</sub> agonists, acetylcholine or carbachol, augmented the open probability of Kir6.2 by up to 30%, an effect that was abolished in the presence of the antagonist atropine. To obtain a D<sub>2</sub>-based ICCR, we directly constructed the fusion D<sub>2</sub>-K<sub>0-25</sub>. This construct was also functional in terms of receptor-channel interactions although the coupling was in opposite direction: D<sub>2</sub> agonists decreased channel activity by up to 40%. We do not yet know why there is positive coupling with M<sub>2</sub> and negative coupling with D<sub>2</sub>. Because it is believed that GPCRs undergo similar conformational changes, we surmise that this difference could be due to sequence differences in the C-termini of M<sub>2</sub> and D<sub>2</sub>. Experimental work is in progress to explore this hypothesis.

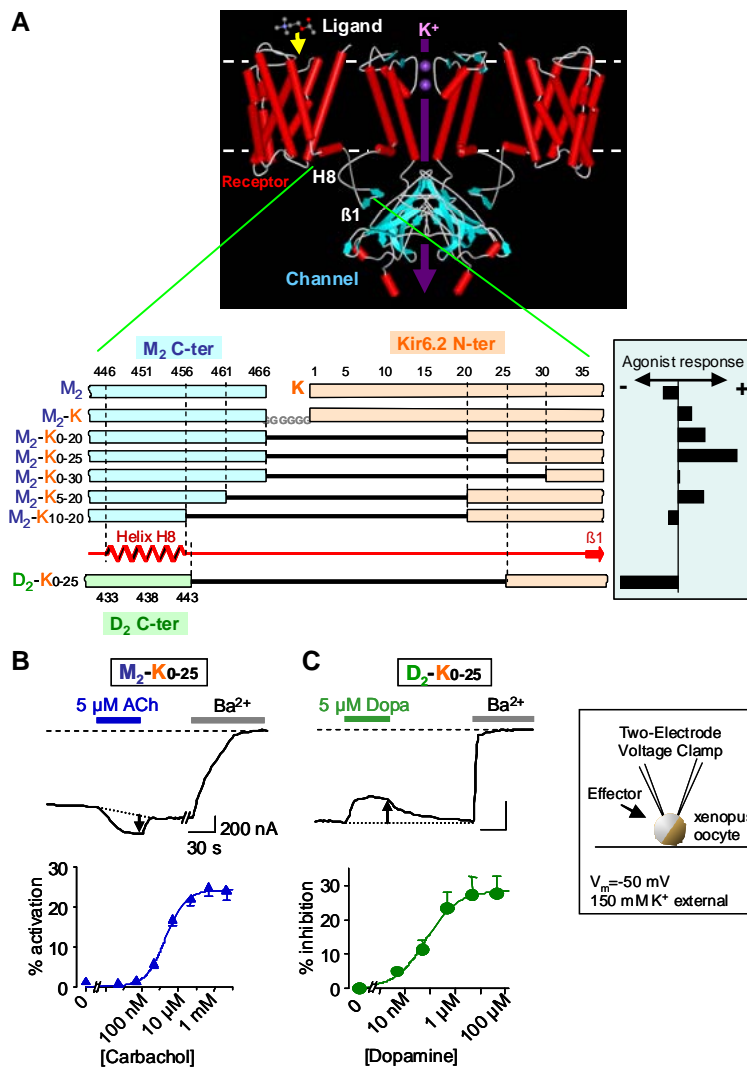

**Figure 2.** ICCRs based on the M<sub>2</sub> and D<sub>2</sub> receptors. **(A)** Transmembrane view of a molecular model of the M<sub>2</sub>-Kir6.2 tetrameric complex built from known structures of bacterial homologues (top) and zoom-in on the region linking GPCR C-ter and Kir6.2 N-ter for selected M<sub>2</sub> and D<sub>2</sub> constructs (bottom). The putative α-helix VIII of GPCRs and a Kir6.2 β-sheet, symbolized in red, are predicted from the structures of the β<sub>2</sub>-adrenergic receptor and Kir3.1. Construct names 'G-K xx-yy' indicate the GPCR name (G), the residues deleted in the GPCR C-ter (xx) and in the Kir6.2 N-ter (yy). Boxed insert at right summarizes the change in current induced by GPCR agonists (5 μM acetylcholine or dopamine) for each constructs. **(B)** Top: Whole-cell response to acetylcholine (ACh) of M<sub>2</sub>-K<sub>0-25</sub>. Bottom: Concentration-dependent change in current induced by the muscarinic agonist carbachol. **C**, Similar data for D<sub>2</sub>-K<sub>0-25</sub> and its agonist dopamine (adapted from Moreau *et al.*, 2008).

**Figure 2.** ICCRs basés sur les récepteurs M<sub>2</sub> et D<sub>2</sub>. **(A)** Vue latérale d'un modèle moléculaire du complexe tétramérique M<sub>2</sub>-Kir6.2 élaboré à partir de structures de homologues bactériens (haut) et agrandissement de la région liant le C-ter du GPCR et le N-ter de Kir6.2 pour quelques constructions M<sub>2</sub> et D<sub>2</sub> (bas). L'hélice α VIII des GPCRs et un feuillet β de Kir6.2, en rouge, sont prédits d'après les structures du récepteur β<sub>2</sub>-adrénergique et de Kir3.1. Les noms des constructions 'G-K xx-yy' indique le nom du GPCR (G), les résidus supprimés du C-ter du GPCR (xx) et du N-ter de Kir6.2 (yy). L'histogramme à droite résume les changements de courant induit par les agonistes testés (5 μM acetylcholine or dopamine) sur chaque construction. **(B)** Haut: Réponse du courant de cellule entière à l'acetylcholine (ACh) de M<sub>2</sub>-K<sub>0-25</sub>. Bas: Variation dose-dépendante de courant induite par l'agoniste muscarinique carbachol. **C**, Idem pour D<sub>2</sub>-K<sub>0-25</sub> et son agoniste dopamine (d'après Moreau *et al.*, 2008).

Using the M<sub>2</sub> and D<sub>2</sub> ICCRs, we were able to measure agonist affinities that were found to be in the range of published values.

Much effort was spent proving that the coupling arose from a direct, mechanical, connection between receptor and channel. Indeed, the involvement of G-proteins in receptor-channel coupling was ruled out by performing experiments in cell-free conditions (excised patch configuration) and in the presence of pertussis toxin to block G-protein activation. We also verified that the fusion process did not alter the basic properties of the two fused proteins. In particular, we showed that the GPCR fused to Kir6.2 retained the ability to

activate G-protein. To demonstrate this, the  $M_2$  and  $D_2$  fusion proteins were co-expressed with G-protein activated Kir3 channels (Vivaudou *et al.*, 1997), a member of the Kir family distinct from Kir6.2 that is activated by direct binding of the G-protein  $\beta\gamma$  subunits and can therefore serve as a probe of receptor-mediated G-protein activation. It was verified that the Kir3 currents were augmented upon application of receptor agonists (Moreau *et al.*, 2008) implying that the fusion with Kir6.2 does not alter significantly the structure and function of the GPCRs.

## Conclusion

Ion-channel based biosensors are attractive because of the electrical nature of the signal, the large currents produced by a single channel that enable single-molecule detection, and the ability to function in the physiological context of a liquid environment.

Engineering of ion-channel derived biosensors has relied on the design of synthetic ion-conducting pores gated by simple chemical ligands (Bayley and Jayasinghe, 2004; Gorteau *et al.*, 2004). More recent, more versatile designs consist of hybrid proteins associating a natural ion channel with the ligand binding domain of a biological receptor (Bouzat *et al.*, 2004; Grutter *et al.*, 2005; Ohndorf and MacKinnon, 2005). Our approach remains unique because it couples a complete, unaltered transmembrane receptor to an ion channel, thus allowing detection of biochemical signals and screening of receptor-targeted pharmacological agents. It permits the study of GPCRs with all the tools available for ion channels, both low-throughput, high-content techniques such as traditional patch clamp, and high-throughput techniques based on automated electrical or fluorescence recordings (Figure 3). GPCRs researchers could enjoy the comfort of ion channel researchers who have been gathering detailed molecular data without having to resort to complex biochemical steps involving overexpression and purification. The ICCR technology could therefore greatly simplify the study of the structure-function relations of GPCRs.

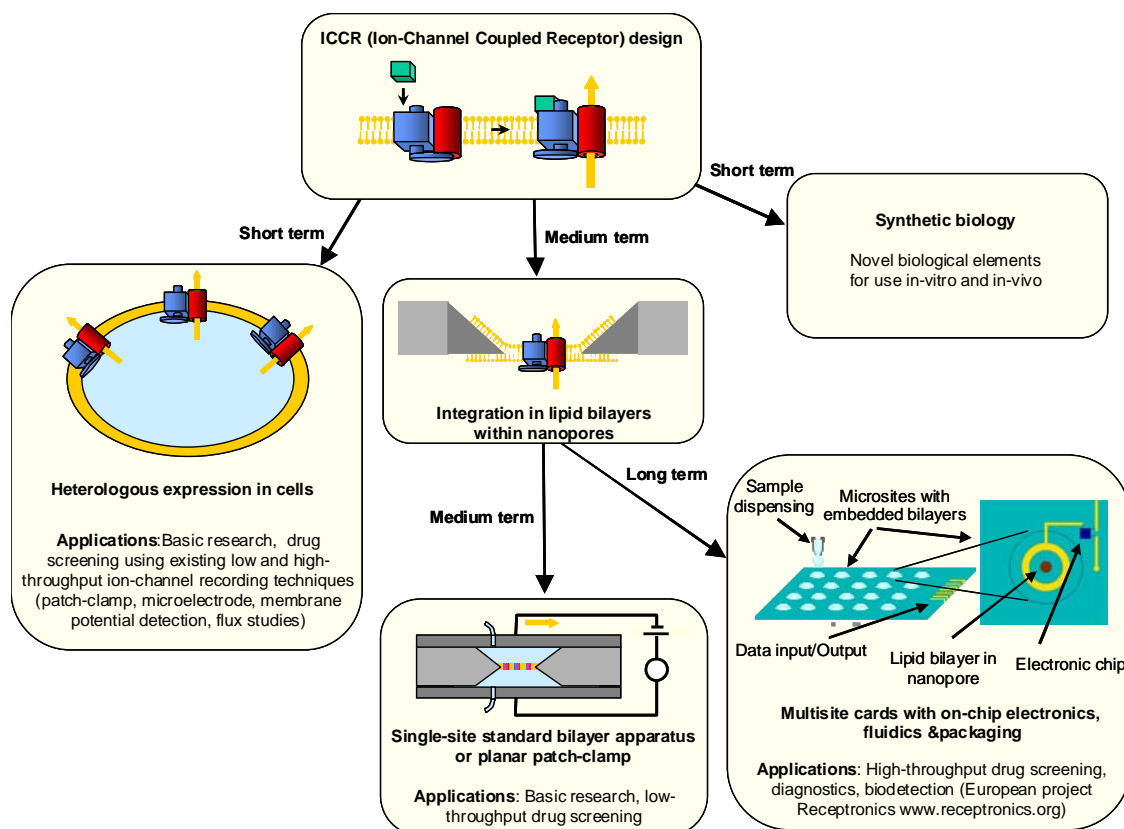

**Figure 3.** The pathways of applications of ICCRs from the design steps and the expression in model cells to stable expression in mammalian cell lines (short-term) to isolation, purification, and integration in miniature devices (long-term; one objective of the European project Receptronics 'Label-free Biomolecular Detectors: at the Convergence of Bioengineered Receptors and Microelectronics').

**Figure 3.** Stratégie d'exploitation des ICCRs des étapes de conception avec expression transitoire dans des modèles cellulaires à l'expression stable dans des lignées cellulaires (court-terme) à l'isolation, la purification, et l'intégration dans des dispositifs miniaturisés (long-terme; un objectif du projet Européen 'Receptronics Label-free Biomolecular Detectors: at the Convergence of Bioengineered Receptors and Microelectronics').

**Acknowledgements.** This work was made possible by grants from the Sixth Framework Program of the European Union (Receptronics project, STREP NMP4-CT-2005-017114) and the Agence Nationale de la Recherche (ICCR project, grant ANR-09-PIRI-0010).

## References

- Bayley H, Jayasinghe L (2004) Functional engineered channels and pores. *Mol Membr Biol* **21**: 209-220
- Bouzat C, Gumilar F, Spitzmaul G, Wang HL, Rayes D, Hansen SB, Taylor P, Sine SM (2004) Coupling of agonist binding to channel gating in an ACh-binding protein linked to an ion channel. *Nature* **430**: 896-900
- Dupuis JP, Revilloud J, Moreau CJ, Vivaudou M (2008) Three C-terminal residues from the sulphonylurea receptor contribute to the functional coupling between the K<sub>ATP</sub> channel subunits SUR2A and Kir6.2. *J Physiol* **586**: 3075-3085
- Gorteau V, Perret F, Bollot G, Mareda J, Lazar AN, Coleman AW, Tran DH, Sakai N, Matile S (2004) Synthetic multifunctional pores with external and internal active sites for ligand gating and noncompetitive blockage. *J Am Chem Soc* **126**: 13592-13593
- Grutter T, Prado de Carvalho L, Dufresne V, Taly A, Fischer M, Changeux JP (2005) A chimera encoding the fusion of an acetylcholine-binding protein to an ion channel is stabilized in a state close to the desensitized form of ligand-gated ion channels. *C R Biol* **328**: 223-234
- Hosy E, Derand R, Revilloud J, Vivaudou M (2007) Remodelling of the SUR-Kir6.2 interface of the K<sub>ATP</sub> channel upon ATP binding revealed by the conformational blocker rhodamine 123. *J Physiol* **582**: 27-39
- Hosy E, Dupuis JP, Vivaudou M (2010) Impact of disease-causing SUR1 mutations on the K<sub>ATP</sub> channel subunit interface probed with a rhodamine protection assay. *J Biol Chem* **285**: 3084-3091
- Lee FJ, Xue S, Pei L, Vukusic B, Chery N, Wang Y, Wang YT, Niznik HB, Yu XM, Liu F (2002) Dual regulation of NMDA receptor functions by direct protein-protein interactions with the dopamine D1 receptor. *Cell* **111**: 219-230
- Liu F, Wan Q, Pristupa ZB, Yu XM, Wang YT, Niznik HB (2000) Direct protein-protein coupling enables cross-talk between dopamine D5 and  $\gamma$ -aminobutyric acid A receptors. *Nature* **403**: 274-280
- Moreau C, Gally F, Jacquet-Bouix H, Vivaudou M (2005a) The size of a single residue of the sulphonylurea receptor dictates the effectiveness of K<sub>ATP</sub> channel openers. *Mol Pharmacol* **67**: 1026-1033
- Moreau C, Jacquet H, Prost AL, D'Hahan N, Vivaudou M (2000) The molecular basis of the specificity of action of K<sub>ATP</sub> channel openers. *EMBO J* **19**: 6644-6651
- Moreau C, Prost AL, Derand R, Vivaudou M (2005b) SUR, ABC proteins targeted by K<sub>ATP</sub> channel openers. *J Mol Cell Cardiol* **38**: 951-963
- Moreau CJ, Dupuis JP, Revilloud J, Arumugam K, Vivaudou M (2008) Coupling ion channels to receptors for biomolecule sensing. *Nature Nanotech* **3**: 620-625
- Nichols CG (2006) K<sub>ATP</sub> channels as molecular sensors of cellular metabolism. *Nature* **440**: 470-476
- Ohndorf UM, MacKinnon R (2005) Construction of a cyclic nucleotide-gated KcsA K<sup>+</sup> channel. *J Mol Biol* **350**: 857-865
- Vivaudou M, Chan KW, Sui JL, Jan LY, Reuveny E, Logothetis DE (1997) Probing the G-protein regulation of GIRK1 and GIRK4, the two subunits of the K-ACh channel, using functional homomeric mutants. *J Biol Chem* **272**: 31553-31560
-



## **Black spot, black death and black pearl : tales of bacterial effectors**

Anne-Marie KRACHLER, Kim ORTH\*

Department of Molecular Biology, UT Southwestern Medical Center, Dallas, Texas 75390, USA

\* Corresponding author ; Tel : +(001) 214 648 1685 ; Fax : +(001) 214 648 1544 ;

E-mail : [kim.orth@utsouthwestern.edu](mailto:kim.orth@utsouthwestern.edu)

---

### **Abstract**

The bacterial pathogen *Vibrio parahaemolyticus* utilizes type-III secretion to cause death of host cells within hours of infection. The cell death is completely independent of apoptosis and occurs by the relentless induction of autophagy followed by cell rounding and the release of cellular contents. The effector VopQ is both sufficient and necessary for the induction of autophagy. The effector VopS AMPylates a conserved threonine residue in the switch I region of Rho GTPases, thereby causing cell rounding through inhibition of downstream signaling pathways. Another effector, VPA0450, is shown to encode a catalytic activity that induces membrane blebbing and acceleration of host cell lysis. These and other, yet to be discovered effectors, contribute to a temporally regulated infection paradigm whereby an extracellular pathogen induces acute cell death of an infected host cell by hijacking critical signaling pathways.

### **Tache noire, mort noire et perle noire : les contes d'effecteurs bactériens**

La bactérie pathogène *Vibrio parahaemolyticus* utilise la sécrétion de type III pour provoquer la mort des cellules hôtes dans les heures suivant l'infection. La mort cellulaire est complètement indépendante de l'apoptose et se produit par l'induction inexorable de l'autophagie suivie de l'arrondissement des cellules et de la libération du contenu cellulaire. L'effecteur VopQ est à la fois nécessaire et suffisant pour l'induction de l'autophagie. L'effecteur VopS produit la fixation d'AMP sur un résidu thréonine conservé dans la région de l'interrupteur I des GTPases Rho, ce qui provoque l'arrondissement des cellules par l'inhibition des voies de signalisation en aval. Un autre effecteur, VPA0450, est présenté comme codant une activité catalytique qui induit le bourgeonnement des membranes et l'accélération de la lyse des cellules hôtes. Ces effets, ainsi que d'autres dont les effecteurs restent encore à découvrir, contribuent à un paradigme règlementé dans le temps de l'infection selon lequel un agent pathogène extracellulaire produit une mort cellulaire aiguë d'une cellule hôte infectée hôte par un détournement des voies de signalisation critiques.

**Keywords** : AMPylation, autophagy, blebbing, T3SS, *Vibrio*.

---

## **Introduction**

Many Gram-negative pathogens of clinical and economic significance use the translocation of type III secreted effector proteins into the host cell cytoplasm to manipulate host cell signaling and the response to infection. Studies on effectors from our lab have included XopD secreted by *Xanthomonas campestris* (Black Spot) and YopJ secreted by *Yersinia spp.* (Black Death). Herein, we focus on a number of effectors secreted by *Vibrio parahaemolyticus*, the causal agent of food poisoning due to the consumption of contaminated raw oysters (Black Pearl).

*Vibrio parahaemolyticus* (*V. para.*) is a Gram-negative bacterium commonly found in marine and estuarine environments (Daniels *et al.*, 2000). Infection typically results from consumption of contaminated shellfish and leads to acute gastroenteritis. Individuals who are immunocompromised or burdened with pre-existing health conditions are at high risk for severe complications that can result in death (Morris and Black, 1985). Although the thermostable direct hemolysin (tdh) is the most well-characterized virulence factor, infection with  $\Delta$ tdh strains of *V. para.* results in rapid and acute cell death in a tissue culture model (Park *et al.*, 2004a). Genome sequencing of the *V. para.* strain RIMD2210633 revealed the presence of two type III secretion systems in addition to the hemolysin toxins, one encoded on chromosome 1 (T3SS1) and the other on chromosome 2 (T3SS2). Bacterial T3SSs deliver bacterial effectors into the cytosol of host cells during infection (Galan, 2009). The effectors, like viral oncoproteins, are potent molecules that mimic or capture an endogenous eukaryotic activity to disrupt the cellular response to infection (Mukherjee *et al.*, 2007; Navarro *et al.*, 2005). T3SS2 is found only in clinical isolates of *V. para.* and is associated with enterotoxicity in a rabbit ileal loop model (Park

*et al.*, 2004b). However, mutant strains unable to secrete proteins from T3SS2 are cytotoxic to tissue culture cells, implicating a role for T3SS1 in virulence (Liverman *et al.*, 2007; Park *et al.*, 2004b). Genotyping has shown that all isolates of *V. para.* harbor T3SS1, which resembles the T3SS of *Yersinia spp.* in structure and organization, albeit there is no similarity between their predicted effectors (Makino *et al.*, 2003; Park *et al.*, 2004a). Initially the cytotoxic effects caused by T3SS1 during infection were thought to occur by apoptosis, but recent studies have revealed that cell death occurs by a very unique mechanism (Bhattacharjee *et al.*, 2006; Burdette *et al.*, 2008; Ono *et al.*, 2006).

Additional insight into the mode of action of the two *V. para.* T3SSs was accomplished with infection studies using HeLa and RAW 264.7 macrophage cell lines and the *V. para.* strain POR1 (lacking the thermostable direct hemolysins) and two isogenic strains derived from POR1 that are incapable of secreting effectors from either T3SS1 (POR2) or T3SS2 (POR3) (Park *et al.*, 2004a). POR1 induces cytotoxicity in both cell lines (Burdette *et al.*, 2008). Although a strain lacking T3SS1 (POR2) is unable to induce cytotoxicity, it is capable of causing drastic changes in the actin cytoskeleton (Burdette *et al.*, 2008; Liverman *et al.*, 2007). Infection of either HeLa or RAW 264.7 macrophage cell lines with a strain lacking T3SS2 (POR3) induces a cytotoxic phenotype similar to that seen in POR1 infected cells (Burdette *et al.*, 2008). Inducing the T3SS1 system with increased temperature and decreased calcium, a treatment similar to that used for *Yersinia spp.*, accelerates the T3SS1-dependent cytotoxic phenotype (Zhang and Bliska, 2005). The remaining experiments described in this study use the POR3 strain to decipher the mechanism used by T3SS1 to induce rapid cytotoxicity.

### ***Vibrio parahaemolyticus* causes a rapid, orchestrated host cell death**

*V. para.*-induced host cell death is independent of apoptosis and occurs by a mechanism that involves the injection of multiple type III effectors causing the induction of autophagy, cell rounding and the subsequent release of cellular contents (Figure 1; Burdette *et al.*, 2008). By necessity these events must occur in a temporally regulated manner. Autophagy is observed very early during the infection and requires a functional actin cytoskeleton for the formation of vesicles. Therefore, the collapse of the actin cytoskeleton has to ensue after autophagy. Likewise, the type III-mediated lysis of the host cell must occur after intracellular regulated events such as autophagy and cell rounding. The reasons for killing a cell in such an orderly fashion are somewhat perplexing.

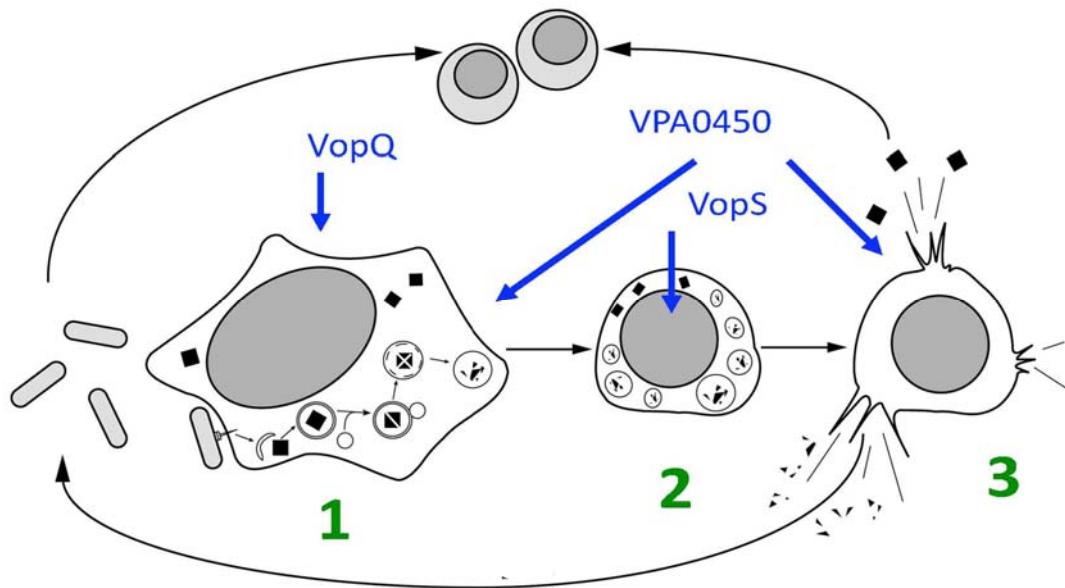

**Figure 1.** *V. parahaemolyticus* induces a series of events that culminates in the efficient death of host cells. *V. parahaemolyticus* utilizes type III secretion to inject effectors into the host cell during infection. This results in the rapid induction of autophagy by VopQ causing the formation of autophagosomes (1). Next, rounding and shrinkage of the infected host cell are caused by the AMPylator VopS (2). Cell rounding is followed by lysis and release of cellular contents, which is accelerated by the presence of VPA0450 (3). We hypothesize that lysis will lead to the release of degraded proteins that can be used by the bacteria for nutrients.

**Figure 1.** *V. parahaemolyticus* provoque une série d'événements qui aboutissent à la mort efficace des cellules hôtes. *V. parahaemolyticus* utilise la sécrétion de type III pour injecter des effecteurs dans la cellule hôte lors de l'infection. Cela se traduit par l'induction rapide de l'autophagie par VopQ, provoquant la formation d'autophagosomes (1). Ensuite, l'arrondissement et le rétrécissement de la cellule hôte infectée sont provoqués par la VopS (2). L'arrondissement cellulaire est suivi d'une lyse et de la libération du contenu cellulaire, ce qui est accéléré par la présence de VPA0450 (3). Nous émettons l'hypothèse que la lyse conduira à la libération de protéines dégradées qui peuvent être utilisées par les bactéries comme éléments nutritifs.

One hypothesis is that *V. para.* induces autophagy to degrade cellular contents to metabolites that the bacteria could easily scavenge after host cells lysis. In the environment, this would provide *V. para.* access to

essential nutrients required for survival. The induction of autophagy also uses up the cellular pool of membrane resources thereby preventing their use in phagocytosis (Burdette *et al.*, 2009b). The cell rounding before lysis would provide a mechanism for concentrating nutrients before releasing them into the environment. In fact, after lysis of a tissue culture cell infected by *V. para.*, the bacteria appear to congregate around the lysing cells as if they might be enjoying a hearty feast after a victorious battle. An interesting result of *V. para.*-induced cell death is the morphology of the dead cell. Electron microscopy images of the dead cells reveal a lace-like membrane web around what appears to be a perfectly healthy nucleus (Burdette *et al.*, 2009b). This morphology has been observed with cells dying by Tamoxifen-induced autophagy (Bursch *et al.*, 1996). How the nuclear compartment in the cell remains intact during the massive insult by *V. para.* infection remains a puzzle. To dissect the molecular events that are causing this multifaceted regulated cell death, we have started to elucidate the activity of the type III effectors used during infection.

### VopQ, inducer of autophagy

Autophagy is marked by lipidation of the microtubule-associated protein light chain 3 (LC3, *Figure 2*), an increase in punctae and vacuole formation. Electron microscopy reveals the production of early autophagic vesicles during infection. PI3 kinase appears to play a partial role in induction of autophagy because treatment of infected cells with a PI3 kinase inhibitor attenuates autophagy in infected cells. We observed that the deletion of one effector, VopQ, completely abolished the ability of *V. para.* to induce autophagy in infected cells, although the infected cells still die as a result of translocation of other effectors (Burdette *et al.*, 2009a). In addition, injection of recombinant VopQ can induce the formation of autophagic vesicles within minutes and this activity was not inhibited by PI3 kinase inhibitors (Burdette *et al.*, 2009a). Based on these and other observations, it was concluded that VopQ is both necessary and sufficient to induce PI3 kinase-independent autophagy. The molecular mechanism used by VopQ to induce autophagy is currently under investigation.

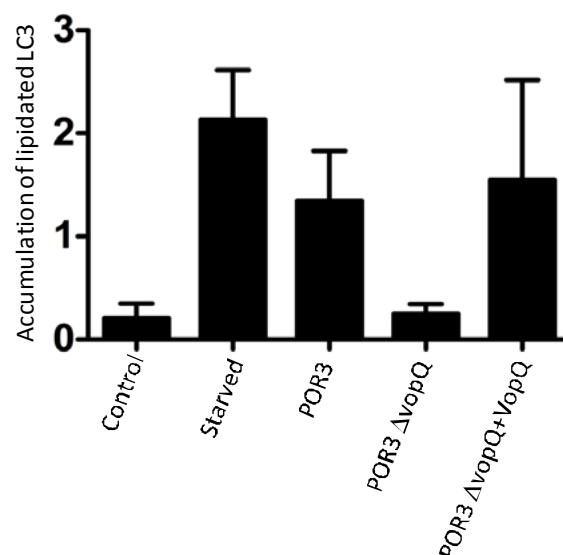

**Figure 2.** VopQ is necessary for T3SS1-mediated induction of autophagy. GFP-LC3 HeLa cells were left uninfected (control), starved with protease inhibitors, or infected with POR3, POR3 $\Delta$ vopQ and POR3 $\Delta$ vopQ+VopQ. The accumulation of lipidated LC3 was measured relative to the level of unlipidated LC3 based on analysis of band intensities after Western Blotting. The data are means from three independent experiments  $\pm$  standard deviation.

**Figure 2.** VopQ est nécessaire pour l'induction de l'autophagie arbitraire par T3SS1. Les cellules HeLa GFP-LC3 ont été soit laissées non infectées (contrôle), affamées par des inhibiteurs de protéases ou infectées par POR3, POR3 $\Delta$ vopQ et POR3 $\Delta$ vopQ+VopQ. L'accumulation de LC3 lipidique a été mesurée par rapport au niveau de LC3 non lipidique sur la base de l'analyse des intensités des bandes après Western Blot. Les données représentent les moyennes de trois expériences indépendantes  $\pm$  la déviation standard.

### VopS, an AMPylator

After *V. para.* induces autophagy, the infected cells round in a synchronized fashion. The actin cytoskeleton in the infected cells appears to collapse as the cells round. Cells infected with a bacterial strain deleted for the effector VopS no longer rounded during infection and the death progression went from flat cells undergoing autophagy directly to cell lysis. Further investigations revealed that VopS is an enzyme that modifies the switch I region of the Rho family of GTPases with AMP (Yarborough *et al.*, 2009). The attachment of AMP sterically precluded the binding of Rho GTPases to respective downstream signaling targets such as PAK (*Figure 3*). This modification, referred to as AMPylation, is thought to be similar to phosphorylation and other post-translational modifications in that it is reversible and changes the activity of the modified protein (Yarborough and Orth, 2009). The first example of a protein to be modified by AMP was discovered by Earl Stadtman when he observed that glutamine synthetase was regulated by modification with AMP (Stadtman *et al.*, 1980).



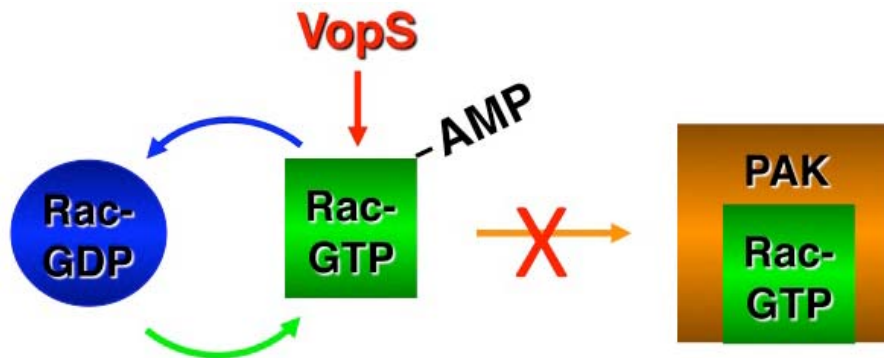
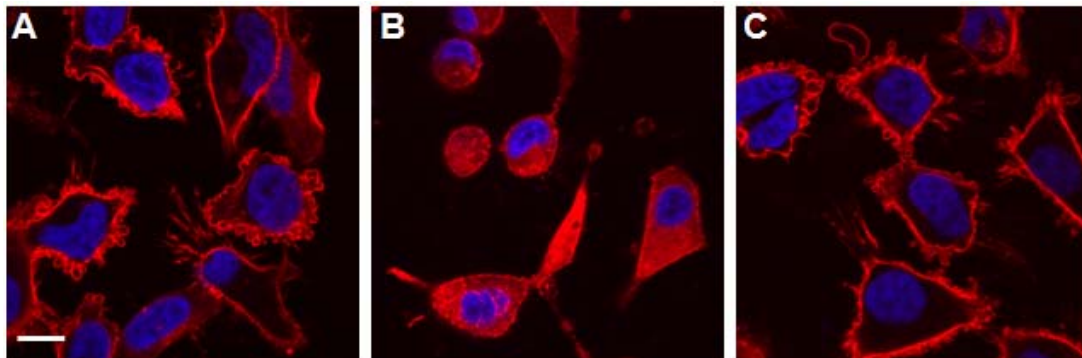

**Figure 3.** VopS AMPylates Rac, thereby preventing its interaction with signaling partner PAK.

**Figure 3.** L'effecteur VopS fixe un AMP sur Rac, empêchant ainsi son interaction avec le partenaire de signalisation PAK.

### VPA0450 facilitates lysis

Another T3SS1 effector secreted by *V. para.* is VPA0450. This effector has been shown to induce membrane blebbing when transfected into HeLa cells. Further analysis revealed that the POR3 strain similarly induces blebbing during infection (Figure 4). The blebbing disappears when VPA0450 is deleted from the POR3 strain and reappears when the deletion strain is reconstituted *in trans* with wild type VPA0450 (Figure 4). Upon infection with the POR3 $\Delta$ vpa0450 strain, lysis of infected cells was delayed by one hour compared to the POR3 strain. The molecular mechanism used by VPA0450 to induce blebbing and delayed lysis is due to its inositol polyphosphate 5-phosphatase activity that disrupts the dynamic interaction of the cell membrane with the actin cytoskeleton (Broberg *et al.*, 2010).



**Figure 4.** POR3 (A) and POR3 $\Delta$ vpa450+VPA450 (C), but not POR3 $\Delta$ vpa0450 (B), induce blebbing in infected cells just before rounding (1.5 hours post-infection). Cells were formaldehyde-fixed and subjected to nuclear staining (Hoechst dye) and actin-staining with rhodamine-phalloidin. Scale bar: 1  $\mu$ M.

**Figure 4.** POR3 (A) et POR3 $\Delta$ vpa450+VPA450 (C), mais pas POR3 $\Delta$ vpa0450 (B), induisent un bourgeonnement dans les cellules infectées juste avant l'arrondissement (1,5 heures après l'infection). Les cellules ont été fixées avec de la formaldéhyde et soumises à une coloration nucléaire (colorant Hoechst), et l'actine colorée à la rhodamine-phalloïdine. Barre d'échelle: 1  $\mu$ M.

### Conclusion

Herein we describe the phenotype of *V. para.* T3SS1-mediated cell death, which has been deciphered using transfection and infections studies with HeLa cells (Burdette *et al.*, 2008). The contribution of three *V. para.* effectors has been analyzed to elucidate their respective contribution to the multifaceted, temporally regulated cell death that involves autophagy, cell rounding and cell lysis. VopQ is both necessary and sufficient to induce autophagy in HeLa cells (Burdette *et al.*, 2009a). Therefore, this activity found in many *Vibrio spp.* does not appear to be redundant with other effectors. VopS is an AMPylator that modifies the switch I region of Rho GTPases with AMP (Yarbrough *et al.*, 2009). The modified Rho GTPases are no longer able to interact with downstream signaling targets, resulting in a collapse of the actin cytoskeleton and rounding of the infected cell. VPA0450 induces blebbing in infected cells and lysis is delayed in the absence of this effector. Many other effectors are thought to contribute to *V. para.*-mediated cell death and future investigations will be directed at understanding the molecular mechanisms they employ to disrupt host cell signaling and promote the spread of infection.

**Acknowledgements.** We thank the Orth lab for insightful discussions and critical reading. K.O and A.M.K. are supported by grants from NIH-Allergy and Infectious Disease (R01-AI056404 and R01-AI087808) and the Welch Foundation (I-1561). K.O. is a Burroughs Wellcome Investigator in Pathogenesis of Infectious Disease, Beckman Young Investigator and a W.W. Caruth, Jr. Biomedical Scholar.

## References

- Bhattacharjee RN, Park KS, Kumagai Y, Okada K, Yamamoto M, Uematsu S, Matsui K, Kumar H, Kawai T, Iida T *et al.* (2006) VP1686, a *Vibrio* type III secretion protein, induces toll-like receptor-independent apoptosis in macrophage through NF- $\kappa$ B inhibition. *J Biol Chem* **281**: 36897-36904
- Broberg CA, Zhang L, Gonzalez H, Laskowski-Arce MA, Orth K (2010) A *Vibrio* effector protein is an inositol phosphatase and disrupts host cell membrane integrity. *Science* **329**: 1660-1662
- Burdette DL, Seemann J, Ort K (2009a) *Vibrio* VopQ induces PI3-kinase-independent autophagy and antagonizes phagocytosis. *Mol Microbiol* **73**: 639-649
- Burdette DL, Yarbrough ML, Orth K (2009b) Not without cause: *Vibrio parahaemolyticus* induces acute autophagy and cell death. *Autophagy* **5**: 100-102
- Burdette DL, Yarbrough ML, Orvedahl A, Gilpin CJ, Orth K (2008) *Vibrio parahaemolyticus* orchestrates a multifaceted host cell infection by induction of autophagy, cell rounding, and then cell lysis. *Proc Natl Acad Sci USA* **105**: 12497-12502
- Bursch W, Ellinger A, Kienzl H, Torok L, Pandey S, Sikorska M, Walker R, Hermann RS (1996) Active cell death induced by the anti-estrogens tamoxifen and ICI 164 384 in human mammary carcinoma cells (MCF-7) in culture: the role of autophagy. *Carcinogenesis* **17**: 1595-1607
- Daniels NA, MacKinnon L, Bishop R, Altekruze S, Ray B, Hammond RM, Thompson S, Wilson S, Bean NH, Griffin PM *et al.* (2000) *Vibrio parahaemolyticus* infections in the United States, 1973-1998. *J Infect Dis* **181**: 1661-1666
- Galan JE (2009) Common themes in the design and function of bacterial effectors. *Cell Host Microbe* **5**: 571-579
- Liverman AD, Cheng HC, Trosky JE, Leung DW, Yarbrough ML, Burdette DL, Rosen MK, Orth K (2007) Arp2/3-independent assembly of actin by *Vibrio* type III effector VopL. *Proc Natl Acad Sci USA* **104**: 17117-17122
- Makino K, Oshima K, Kurokawa K, Yokoyama K, Uda T, Tagomori K, Iijima Y, Najima M, Nakano M, Yamashita A *et al.* (2003) Genome sequence of *Vibrio parahaemolyticus*: a pathogenic mechanism distinct from that of *V. cholerae*. *Lancet* **361**: 743-749
- Morris JG Jr, Black RE (1985) Cholera and other vibrioses in the United States. *N Engl J Med* **312**: 343-350
- Mukherjee S, Hao YH, Orth K (2007) A newly discovered post-translational modification--the acetylation of serine and threonine residues. *Trends Biochem Sci* **32**: 210-216
- Navarro L, Alto NM, Dixon JE (2005) Functions of the *Yersinia* effector proteins in inhibiting host immune responses. *Curr Opin Microbiol* **8**: 21-27
- Ono T, Park KS, Ueta M, Iida T, Honda T (2006) Identification of proteins secreted via *Vibrio parahaemolyticus* type III secretion system 1. *Infect Immun* **74**: 1032-1042
- Park KS, Ono T, Rokuda M, Jang MH, Okada K, Iida T, Honda T (2004a) Functional characterization of two type III secretion systems of *Vibrio parahaemolyticus*. *Infect Immun* **72**: 6659-6665
- Park KS, Ono T, Rokuda M, Jang MH, Iida T, Honda T (2004b) Cytotoxicity and enterotoxicity of the thermostable direct hemolysin-deletion mutants of *Vibrio parahaemolyticus*. *Microbiol Immunol* **48**: 313-318
- Stadtman ER, Hohman RJ, Davis JN, Wittenberger M, Chock PB, Rhee SG (1980) Subunit interaction of adenylylated glutamine synthetase. *Mol Biol Biochem Biophys* **32**: 144-156
- Yarbrough ML, Li Y, Kinch LN, Grishin NV, Ball HL, Orth K (2009) AMPylation of Rho GTPases by *Vibrio* VopS disrupts effector binding and downstream signaling. *Science* **323**: 269-272
- Yarbrough ML, Orth K (2009) AMPylation is a new post-translational modification. *Nat Chem Biol* **5**: 378-379
- Zhang Y, Bliska JB (2005) Role of macrophage apoptosis in the pathogenesis of *Yersinia*. *Curr Top Microbiol Immunol* **289**: 151-173
-



## ***L'hémolysine gamma de Staphylococcus aureus : plus qu'une toxine formant des pores***

Mira TAWK<sup>1</sup>, Benoit-Joseph LAVENTIE<sup>1</sup>, Emmanuel JOVER<sup>2</sup>, Bernard POULAIN<sup>2</sup>, Gilles PREVOST<sup>1\*</sup>

<sup>1</sup> EA-4438 Physiopathologie et Médecine Translationnelle, Institut de Bactériologie de la faculté de médecine, Université de Strasbourg, 3 rue Koeberlé, F-67000 Strasbourg, France ; <sup>2</sup> INCI – UPR-CNRS 3212, Neurotransmission et sécrétion neuroendocrine, 5 rue Blaise Pascal, F-67084 Strasbourg cedex, France

\* Auteur correspondant ; Tél : +33 (0)3 6885 3757 ; Fax : +33 (0)3 6885 3808 ; Courriel : [prevost@unistra.fr](mailto:prevost@unistra.fr)

---

### **Résumé**

*L'hémolysine gamma HlgC-HlgB est une leucotoxine formant des pores de Staphylococcus aureus produite par 99% des souches. Son activité de fragilisation de la membrane plasmique conduit à une entrée d'eau et une perte d'ions et de molécules essentielles ayant pour conséquence l'arrêt des processus vitaux et finalement à la mort cellulaire. Mais l'activité de l'hémolysine gamma HlgC-HlgB va bien au-delà de la simple formation de pores. Sa fixation aux neutrophiles provoque une entrée rapide et massive de calcium dans la cellule indépendamment de la formation du pore. Cette revue propose de remettre en lumière cette activité de la HlgC-HlgB dans son contexte et de relater de récentes découvertes sur l'origine et les voies de signalisation empruntées.*

### **Staphylococcus aureus gamma-hemolysin : more than just a pore forming toxin**

*The gamma-hemolysin HlgC-HlgB is a pore-forming leukotoxin produced by 99% of Staphylococcus aureus strains. Its activity consists in a disruption of the plasma membrane, leading to a water entry and a leak of essential ions and molecules that results in the cessation of vital processes and ultimately to cell death. But the activity of gamma-hemolysin-HlgC HlgB goes far beyond the simple pore formation. Its binding to neutrophils causes a rapid and massive entry of calcium into the cell independently of pore formation. This review proposes to spotlight this neglected activity of HlgC-HlgB in its context and to relate recent findings on the origin and the signalling pathways borrowed.*

**Keywords :** Calcium signalling pathways, gamma-hemolysin, leucotoxins, neutrophils, Staphylococcus aureus.

---

## **Introduction**

### **L'hémolysine gamma (Hlg) de *S. aureus***

*Staphylococcus aureus* (*S. aureus*) est l'une des bactéries pathogènes la plus fréquemment rencontrée à l'hôpital, et les souches résistantes communautaires ne sont plus rares (Etienne, 2005). Elle est responsable du syndrome du choc toxique, de toxi-infections alimentaires collectives, d'infections cutanées ou profondes (ex : de pneumopathies). Son pouvoir pathogène, vis-à-vis d'infections profondes et destructrices, lui est conféré par de nombreux facteurs de virulence. Nous pouvons citer des facteurs d'adhésion (MSCRAMMs) qui assurent la capacité de former des biofilms sur tous les tissus (ex : valves cardiaques), des protéases (hyaluronidase, collagénase, lipase, nucléase) pour la récupération de nutriments et le pouvoir invasif, des superantigènes (entérotoxines, TSST-1), et une famille de toxines formant des pores : les leucotoxines ; conférant une résistance aux antibiotiques et au système immunitaire. Ces dernières jouent un rôle d'échappement au système immunitaire en ciblant directement, comme leur nom le suggère, les leucocytes. Il s'agit d'une part de lyser les leucocytes résidents dans les tissus (macrophages, cellules dendritiques), mais aussi les leucocytes circulants rapidement recrutés au site d'infection (neutrophiles, basophiles, éosinophiles) représentant tous des types cellulaires centraux de l'immunité innée. Liées à la pathologie humaine, les leucotoxines comprennent l'alpha-toxine et une série de toxines bipartites (association d'une protéine dite de classe S et d'une protéine de classe F) : les hémolysines gamma (couples HlgA-HlgB et HlgC-HlgB), la leucocidine de Pantou et Valentine ou « LPV » (LukS-PV-LukF-PV), et le couple LukE-LukD.

### **Impact clinique**

Les hémolysines gamma sont produites par 99% des souches de *S. aureus* (Arciola *et al.*, 2007; Prévost *et al.*,

1995a; von Eiff *et al.*, 2004). Elles sont décrites comme un facteur aggravant de la sévérité de l'infection et participent au processus d'inflammation (Girgis *et al.*, 2005; Supersac *et al.*, 1998). L'injection de seulement 600 ng de HlgC-HlgB ou HlgA-HlgB purifiés induit des lésions inflammatoires dans plusieurs sites chez le lapin (derme, intestin, œil,...) (Prévost *et al.*, 1995b). Cependant, aucune association clinique précise n'est décrite en raison de l'absence de souches de *S. aureus* non productrices d'hémolysine gamma comme point de comparaison. Cette toxine pourrait être un marqueur d'identification de la bactérie.

### Organisation génétiques du locus de l'hémolysine gamma

La première des 2 unités de transcription du locus de l'hémolysine gamma code la protéine HlgA, la deuxième code 2 cadres de lecture ouverts cotranscrits correspondant à HlgC puis HlgB (Cooney *et al.*, 1993; Prévost *et al.*, 1995b). Les 2 premiers cadres de lecture codent 2 protéines de classe S (HlgA et HlgC), et le 3<sup>ème</sup> la protéine de classe F (HlgB). Comme pour toutes les leucotoxines bipartites, c'est l'association d'une protéine de classe S et d'une protéine de classe F qui formera un oligomère fonctionnel. Ainsi, il existe 2 hémolysines gamma distinctes aux propriétés différentes : HlgA-HlgB et HlgC-HlgB, l'objet de cette revue.

## Les activités de l'hémolysine gamma HlgC-HlgB

### Spécificité cellulaire

Tout comme la LPV, l'hémolysine gamma HlgC-HlgB est capable de cibler des granulocytes (neutrophiles, basophiles, éosinophiles), ainsi que les monocytes et leur descendance : macrophages et cellules dendritiques. Contrairement à la LPV et LukE-LukD, le couple HlgC-HlgB possède une activité hémolytique sur les érythrocytes humains et de lapin (Prévost *et al.*, 1995b).

### Un récepteur de l'hémolysine gamma ?

La fixation initiale de HlgC est obligatoire pour la fixation secondaire de HlgB. Un feuillet beta est l'un des domaines fonctionnels impliqués (Meunier *et al.*, 1997). La fixation de HlgC sur la membrane plasmique est probablement réalisée *via* un ligand spécifique, au moins transitoirement. Cette hypothèse est suggérée par les éléments suivants: 1) la fixation de HlgC est saturable, 2) HlgC entre en compétition avec LukS-PV (le composé de classe S de la LPV), 3) la fixation de HlgC aux neutrophiles est inhibée par le phorbol myristyl-acétate (PMA), un activateur de la voie de la protéine kinase C (PKC), 4) la staurosporine, un antagoniste du PMA, rétablit la fixation (Gauduchon *et al.*, 2001). D'autres auteurs prônent une fixation de HlgC à un ganglioside membranaire : 1) HlgC se fixerait sur le monoganglioside GM1 (Noda *et al.*, 1980), 2) le résidu W<sup>275</sup> est essentiel pour la fixation de HlgC à GM1 (Nariya, Kamio, 1995), 3) le segment de 5 résidus I<sup>242</sup>-K-R-S-T<sup>246</sup> est indispensable à la fonction de HlgC (Nishiyama *et al.*, 2006), mais les auteurs ne décrivent qu'un impact sur l'activité globale de HlgC sans démontrer l'impact sur la fixation de la protéine. Des données personnelles sur le domaine responsable de la fixation sur LukS-PV convergent uniquement sur la région homologue de LukS-PV. Il est également intéressant de noter que HlgC ne partage pas le même site de fixation que HlgA, l'autre composé de classe S de l'hémolysine gamma. Le couple HlgA-HlgB est en fait hémolytique et la fixation de HlgA est probablement dirigée par les lipides membranaires (Ferrerias *et al.*, 1998; Potrich *et al.*, 2009), ce qui n'est pas le cas de la LPV. HlgC possède donc des propriétés distinctes de LukS-PV et HlgA, qui se reflètent dans les hypothèses de son mode de fixation où plusieurs modalités sont proposées et pourraient coexister.

### Une activité de formation de pore ...

Après la fixation initiale de HlgC puis HlgB, les 2 composés s'oligomérisent de façon alternée pour finalement former un pore hexamérique (Ferrerias *et al.*, 1998; Meunier *et al.*, 1997), heptamérique (Sugawara-Tomita *et al.*, 2002) ou, plus probablement, octamérique (Joubert *et al.*, 2006; Miles *et al.*, 2002). Comme toutes les toxines formant des pores, l'hémolysine gamma HlgC-HlgB forme un pore transmembranaire en reconfigurant un feuillet beta pour former un tonneau  $\beta$  (Finck-Barbançon *et al.*, 1993). Le pore, dont le diamètre est évalué à environ 19-21 Å (Sugawara *et al.*, 1997), est spécifique des cations monovalents. Son ouverture entraîne la fuite de potassium, la perte de nucléotides, de sucres phosphatés, de nutriments ; l'entrée de sodium et d'eau, conduisant au déséquilibre de l'homéostasie ionique, osmotique, du métabolisme de la cellule, et finalement à sa lyse. Pour certaines PFTs, la formation de pores est capable à elle seule d'activer des voies de signalisation, à l'instar de l'alpha-toxine de *S. aureus*, de la Cytolysine de *Vibrio cholerae* (VCC), de la Streptolysine O (SLO), ou encore de l'hémolysine HlyA d'*Escherichia coli* qui activent la MAPK p38 en provoquant une perte du potassium cellulaire (Kloft *et al.*, 2009).

### ... mais pas seulement

Le mécanisme de formation de pores est spécifique des sous-familles de PFTs, avec des variations de diamètre des pores, de sélectivité ionique, et de stœchiométrie. Cependant, cette activité longtemps considérée comme la principale, n'est pas la seule, et d'autres fonctions des PFTs sont décrites. Par exemple la Streptolysine O et l'hémolysine d'*Escherichia coli* sont deux PFTs qui provoquent une perte rapide et massive du récepteur à l'IL-6 et du récepteur du LPS (CD14) (Walev *et al.*, 1996). Une particularité distingue également les leucotoxines: elles provoquent une augmentation massive et rapide de la concentration en calcium intracellulaire ( $[Ca^{2+}]_i$ ) dès la fixation des deux composés. Jusqu'à maintenant, de rares publications font état de modulations de ce flux calcique. Nous avons décrit qu'en présence d'une concentration physiologique de calcium (Staali *et al.*, 1998), la concentration du calcium libre augmente rapidement dans les cellules et provoque une augmentation de la fluorescence de sondes calciques de type Fura-2 ou Fluo-3 (Colin *et al.*, 1994; Finck-Barbançon *et al.*, 1993). Des inhibiteurs des canaux calciques comme l'Econazole, le Vérapamil et le D-600 bloquent le flux de calcium

alors que l'entrée d'éthidium est maintenue (Staal *et al.*, 1998). Des modifications dans le domaine « Stem », telles que les délétions ou les mutations, provoquent un découplage du mécanisme de formation de pores et du flux de calcium démontrant l'indépendance des deux phénomènes (Baba-Moussa *et al.*, 1999; Werner *et al.*, 2002). Cependant, les voies de signalisation activées, les récepteurs et canaux mis en jeu ne sont pas décrits.

### Conséquences pour la cellule

Cette chaîne d'évènements induit plusieurs réponses cellulaires. Elle induit la néosynthèse et la sécrétion de leucotriène B<sub>4</sub> et d'IL-8 (Hensler *et al.*, 1994), d'histamine (König *et al.*, 1995) et de dérivés réactifs de l'oxygène (NO, ROS...) par dégranulation des neutrophiles humains (Colin, Monteil, 2003). Des doses subtyliques de leucotoxines induisent également l'apoptose (Genestier *et al.*, 2005; Köller *et al.*, 1993). La lyse des cellules accroît la libération de médiateurs chimioattractants induisant le recrutement de leucocytes, la vasodilatation, l'invasion cellulaire, puis la nécrose cellulaire.

Notre équipe a récemment mené des investigations pour comprendre les mécanismes sous jacents, les voies de signalisation activées, leur déclencheur et les conséquences sur les cellules et l'inflammation.

### Origine du Calcium

L'augmentation de la concentration en calcium intracellulaire ( $[Ca^{2+}]_i$ ) dans les neutrophiles peut faire suite à la libération du  $Ca^{2+}$  à partir des stocks intracellulaires (réticulum endoplasmique (RE), stocks acides (Menteyne *et al.*, 2006), mitochondries), à l'entrée du calcium extracellulaire ou les deux à la fois. Pour identifier le mécanisme qui conduit à cette augmentation de la  $[Ca^{2+}]_i$  accompagnant la formation du pré-pore suite à la fixation des leucotoxines dans des conditions physiologiques (1 mM de  $Ca^{2+}$  dans le milieu extracellulaire), il faut d'abord identifier l'origine de ce  $Ca^{2+}$ . Pour cela, les variations de la  $[Ca^{2+}]_i$  sont suivies en présence et en absence de  $Ca^{2+}$  extracellulaire par spectrofluorimétrie en utilisant le Fura-2/AM comme sonde calcique. En absence de  $Ca^{2+}$  extracellulaire, l'ajout de HlgC-HlgB induit une augmentation significative de la concentration en  $[Ca^{2+}]_i$ , cependant beaucoup plus faible qu'en présence de  $Ca^{2+}$  extracellulaire où l'ajout des leucotoxines induit une forte et très rapide augmentation de la  $[Ca^{2+}]_i$ . Ceci montre qu'une partie du  $Ca^{2+}$  intracellulaire provient du milieu extracellulaire alors qu'une partie provient des stocks intracellulaires comme dans le cas de l'activation des neutrophiles par le fMLP (Dougherty *et al.*, 1984; Fruman *et al.*, 1991; Morita *et al.*, 2008) qui est un médiateur de réactions inflammatoires sécrété par certaines bactéries comme *Escherichia coli* (Marasco *et al.*, 1984) et *Helicobacter pylori* (Mooney *et al.*, 1991). L'augmentation de la  $[Ca^{2+}]_i$  au niveau des neutrophiles peut se faire alors par activation de deux voies de relargage des stocks calciques intracellulaires très étudiées : la voie de l'IP3 et la voie des canaux sensibles à la Ryanodine.

### Implication de la voie IP3

L'activation de la voie de l'IP3 intervient suite à la fixation d'un activateur sur des récepteurs spécifiques couplés aux protéines G (RCPG) au niveau de la membrane plasmique conduisant à l'activation des phospholipases C (PLC). Ces derniers hydrolysent le Phosphatidylinositol 4,5-bisphosphate (PIP2) en inositol 1,4,5-trisphosphate (IP3) et diacylglycérol (DAG) qui sont des messagers intracellulaires permettant l'augmentation de la  $[Ca^{2+}]_i$ . L'IP3, très mobile dans le cytoplasme, diffuse à l'intérieur de la cellule au niveau du RE, où il se lie au récepteur spécifique IP3R qui change alors de conformation et forme un canal permettant la sortie du  $Ca^{2+}$  présent en forte concentration dans le RE. L'ouverture des IP3R est également régulée par le  $Ca^{2+}$  cytosolique. Puis des canaux calciques membranaires activés par l'augmentation du  $Ca^{2+}$  intracellulaire et des messagers secondaires permettent une amplification de la  $[Ca^{2+}]_i$ . Afin d'identifier la participation ou non de cette voie dans la signalisation calcique due à l'action de HlgC-HlgB, des inhibiteurs qui agissent à différents niveaux de cette voie ont été testés.

Le 2-APB agit à deux niveaux. Il empêche la libération des stocks intracellulaires par inhibition des IP3Rs (Maruyama *et al.*, 1997) et l'entrée de  $Ca^{2+}$  extracellulaire par inhibition des canaux SOCs (Iwasaki *et al.*, 2001; Pan *et al.*, 2008; Peppiatt *et al.*, 2003). Dans le cas de la leucotoxine HlgC-HlgB, la libération du  $Ca^{2+}$  des stocks réticulaires se fait principalement par les IP3Rs puisque le 2-APB inhibe complètement l'augmentation de la  $[Ca^{2+}]_i$  en absence de  $Ca^{2+}$  extracellulaire (Figure 1a). De plus, la Figure 1b montre que le 2-APB inhibe fortement l'augmentation de la  $[Ca^{2+}]_i$  en présence de  $Ca^{2+}$  extracellulaire impliquant aussi les canaux SOCs dans la signalisation calcique. Un autre inhibiteur agissant au niveau de la voie de l'IP3 est utilisé pour vérifier l'implication de cette voie dans la signalisation calcique causée par HlgC-HlgB : le LY-294002. Cette drogue est un inhibiteur de la phosphoinositol 3-kinase (PI3K) qui transforme le PIP2, soit l'un de ses substrats principaux, en Phosphatidylinositol trisphosphate (PIP3) (Carpenter *et al.*, 1990). Le PIP2 est également le substrat des PLC qui le clivent en IP3 et DAG. Le LY-294002 permet donc, en inhibant la PI3K, d'augmenter la concentration du PIP2 (Milosevic *et al.*, 2005) activant ainsi la voie de l'IP3. En présence de  $Ca^{2+}$  extracellulaire, HlgC-HlgB induit une augmentation de la  $[Ca^{2+}]_i$  dans les cellules incubées avec du LY-294002 par rapport au contrôle positif. L'inhibition de l'activité de la PI3K peut permettre l'augmentation du taux de PIP2 en empêchant sa phosphorylation en PIP3. Le PIP2 et de ce fait la voie de l'IP3 sont donc effectivement impliqués dans la signalisation calcique de HlgC-HlgB.

La libération des stocks réticulaires en présence de HlgC-HlgB implique donc les canaux IP3Rs suite à l'activation de la voie de l'IP3.

### Exclusion de la voie ryanodine

Une autre voie pouvant être impliquée passe par les récepteurs sensibles à la ryanodine (RyRs) présents au niveau du RE et qui ont été identifiés au niveau des neutrophiles par immunofluorescence (Clark et Petty,

2005) et RT-PCR (Morita *et al.*, 2008). Ces récepteurs sont structurellement et fonctionnellement analogues aux IP3Rs et sont sensibles au  $Ca^{2+}$  cytosolique. Ils sont activés par l'ADP-ribose cyclique (cADPr) qui est un messager secondaire synthétisé par l'ectoenzyme CD38 à partir de  $\beta$ -NAD<sup>+</sup> grâce à son activité ADP-ribosyl cyclase (Lee, 2001; Partida-Sanchez *et al.*, 2001). Enfin, l'augmentation de la  $[Ca^{2+}]_i$ , de même que le cADPr permettent l'activation de canaux membranaires. Des inhibiteurs agissant au niveau de cette voie ont été utilisés dans le but d'identifier sa participation ou non dans la signalisation calcique due à HlgC-HlgB.

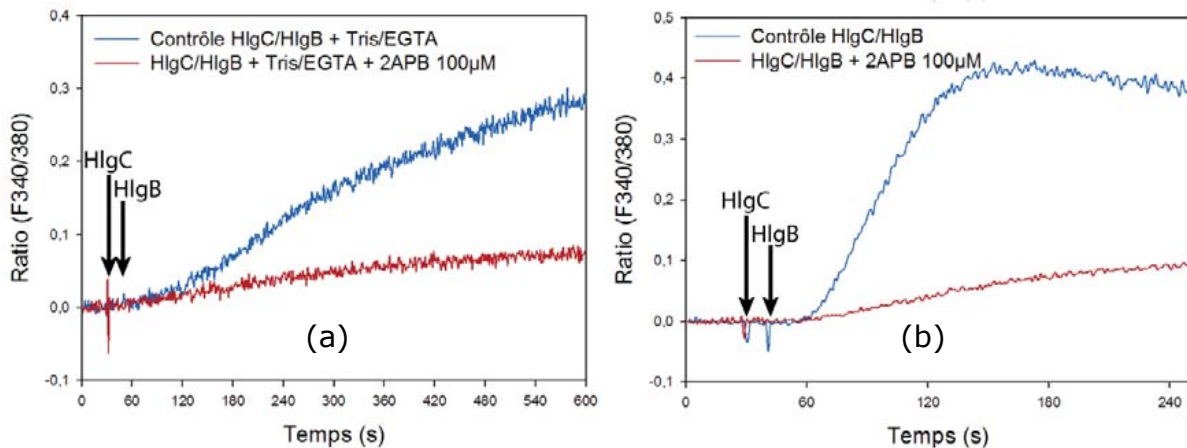

**Figure 1.** Effet du 2-APB sur l'augmentation de la  $[Ca^{2+}]_i$  due à HlgC-HlgB. En absence de  $Ca^{2+}$  extracellulaire (a), le 2-APB inhibe complètement l'augmentation de la  $[Ca^{2+}]_i$  en présence de HlgC-HlgB. De même, en présence de  $Ca^{2+}$  extracellulaire (b), le 2-APB inhibe fortement l'augmentation de la  $[Ca^{2+}]_i$  après traitement des PMNs par HlgC-HlgB. Ces résultats montrent que les IP3Rs, les SOCs et de ce fait la voie de l'IP3 sont impliqués dans la signalisation calcique de HlgC-HlgB.

**Figure 1.** Effect of 2-APB on the increase of  $[Ca^{2+}]_i$  due to HlgC-HlgB. In the absence of extracellular  $Ca^{2+}$  (a), 2-APB completely inhibited the increase in  $[Ca^{2+}]_i$  in the presence of HlgC-HlgB. Similarly, in the presence of extracellular  $Ca^{2+}$  (b), 2-APB strongly inhibited the increase in  $[Ca^{2+}]_i$  after treatment of cells with HlgC-HlgB. These results indicate that IP3R, SOCs and thus, IP3 pathway of hPMNs are involved in calcium signaling of HlgC-HlgB.

La ryanodine est un alcaloïde extrait de plantes qui agit au niveau des RyRs. Elle a deux effets opposés. A faible concentration (ordre du nanomolaire), la ryanodine stimule l'ouverture de ces canaux permettant la sortie du calcium des stocks réticulaires et augmentant le calcium cytosolique. A fortes concentrations (ordre du micromolaire), la ryanodine inhibe les RyRs. En condition physiologique, la ryanodine utilisée à concentrations inhibitrices n'a aucun effet significatif sur l'augmentation de la  $[Ca^{2+}]_i$  provoquée par HlgC-HlgB. Probablement, les RyRs n'interviennent pas dans la signalisation calcique de cette leucotoxine. Le glutathion (GSH) induit l'internalisation de l'ectoenzyme CD38 responsable de la formation du cADPr qui active les RyRs. Cette internalisation conduit à l'augmentation de la concentration de cADPr et par la suite à l'augmentation de la  $[Ca^{2+}]_i$ , bien que le site actif du CD38 soit orienté vers l'intérieur des vésicules (Zocchi *et al.*, 1999). En condition physiologique, le GSH à une concentration de 100  $\mu$ M n'a pas d'effet significatif sur l'augmentation de la  $[Ca^{2+}]_i$ , en présence de HlgC-HlgB, renforçant les résultats précédents avec la ryanodine et permettant d'exclure cette voie de la signalisation calcique suite à la fixation de HlgC-HlgB aux neutrophiles.

### Canaux calciques impliqués

L'entrée de  $Ca^{2+}$  extracellulaire peut se faire à travers de nombreux canaux membranaires qui ont été décrits au niveau des neutrophiles. Au sein de la grande famille des canaux TRP (transient receptor potential), des études au niveau de l'ARNm ou des protéines ont montré différents niveaux d'expression de ces derniers. En particulier, les canaux TRPC1, TRPC3, TRPC4 et TRPC6 de la sous-famille C (classique) ont été identifiés pour les neutrophiles (Brechard et Tschirhart, 2008; Heiner *et al.*, 2003; Itagaki *et al.*, 2004; McMeekin *et al.*, 2006). Au niveau de la sous-famille des canaux vanilloïdes, TRPV1, TRPV2, TRPV5 et TRPV6 sont exprimés au niveau des neutrophiles (Heiner *et al.*, 2003; Itagaki *et al.*, 2004), et enfin TRPM2 de la sous-famille des TRPs du type mélastatine (Brechard et Tschirhart, 2008). Certains de ces TRP sont des SOCs (Store-Operated Channels) (Brechard et Tschirhart, 2008) permettant l'entrée de  $Ca^{2+}$  extracellulaire suite à l'augmentation de la  $[Ca^{2+}]_i$ .

Afin d'identifier les canaux permettant l'influx du  $Ca^{2+}$  extracellulaire, différents inhibiteurs de canaux calciques membranaires ont été également utilisés. Ces canaux peuvent être activés par les produits de la voie de l'IP3 ou bien par d'autres composés. Les canaux TRPM2 de la grande famille des TRPs jouent un rôle important dans le processus d'activation des neutrophiles (Heiner *et al.*, 2005). Ils sont activés par l'ADPr qui se lie à un domaine de l'extrémité C-terminale cytosolique de ces canaux (Perraud *et al.*, 2001). L'ADPr est un métabolite du cADPr et du  $\beta$ -NAD<sup>+</sup> hydrolysés tous deux par le CD38. L'antagoniste du cADPr, le 8-bromo-cADPr (8Br-cADPr) est utilisé de ce fait comme un inhibiteur des RyRs et surtout des canaux TRPM2. En conditions physiologiques, l'augmentation de la  $[Ca^{2+}]_i$  due à HlgC-HlgB est réduite d'environ 50% suite à l'incubation des neutrophiles en présence de 8Br-cADPr. Comme les RyRs semblent ne pas intervenir dans la signalisation calcique en présence de HlgC-HlgB, l'inhibition de l'augmentation de la  $[Ca^{2+}]_i$  proviendrait de

l'absence d'activation des canaux TRPM2 qui interviennent dans la signalisation calcique due à cette leucotoxine.

Les canaux TRPV identifiés au niveau des neutrophiles sont les TRPV1, TRPV2, TRPV5 et TRPV6. TRPV1 et TRPV2, qui partagent 50% d'identité, sont des canaux perméables aux ions  $Ca^{2+}$  et sont aussi activés par l'augmentation de la température et la diminution du pH (Caterina *et al.*, 1997). TRPV5 et TRPV6 ont une très forte sélectivité pour le calcium (den Dekker *et al.*, 2003) et sont contrôlés par la  $[Ca^{2+}]_i$  (Hoenderop *et al.*, 2003). Le rouge de ruthénium (RR) est un inhibiteur des canaux TRPV (Clapham *et al.*, 2001; den Dekker *et al.*, 2003; Szallasi et Blumberg, 1999), ainsi que des RyRs (Phillippe, Basa, 1996). Il est utilisé pour identifier la participation de ces canaux dans la conductance calcique. En condition physiologique, le RR inhibe l'augmentation de la  $[Ca^{2+}]_i$  due à HlgC-HlgB d'une manière dépendante de la concentration de RR (Figure 2a). En absence de  $Ca^{2+}$  extracellulaire, l'inhibition de l'augmentation de la  $[Ca^{2+}]_i$  est négligeable à forte concentration de RR (100  $\mu$ M) montrant que l'effet du RR provient de l'inhibition des canaux TRPV (Figure 2b). Ainsi, ces canaux TRPV jouent un rôle important dans la signalisation calcique sous l'effet de HlgC-HlgB.

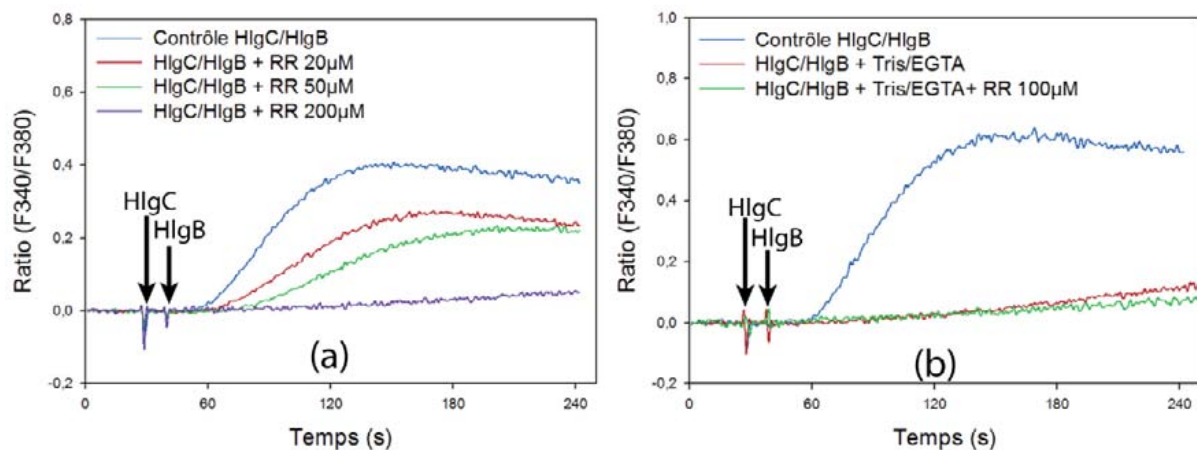

**Figure 2.** Effet du RR sur l'augmentation de la  $[Ca^{2+}]_i$  due à HlgC-HlgB. Le RR inhibe l'augmentation de la  $[Ca^{2+}]_i$  en présence de HlgC-HlgB de manière dépendante de la concentration de RR (a). En absence de  $Ca^{2+}$  extracellulaire, le RR a peu d'effet sur l'augmentation de la  $[Ca^{2+}]_i$  montrant que l'effet du RR provient de l'inhibition des canaux TRPV (b). Le RR bloque les TRPV1, 2, 5, et 6 et le RyR qui, lui, n'est pas impliqué dans la signalisation de HlgC-HlgB. Les canaux TRPV jouent un rôle important dans la signalisation calcique de HlgC-HlgB

**Figure 2.** Effect of RR on the increase of  $[Ca^{2+}]_i$  due to HlgC-HlgB. RR inhibits the increase in  $[Ca^{2+}]_i$  in the presence of HlgC-HlgB in a concentration dependent manner (a). In the absence of extracellular  $Ca^{2+}$ , the RR has little effect on the increase in  $[Ca^{2+}]_i$  showing that the effect of RR comes from the inhibition of TRPV channels (b). RR blocks TRPV1, 2, 5 and 6 and the RyR which is not involved in signaling HlgC-HlgB. The TRPV channels play an important role in calcium signaling of HlgC-HlgB.

Comme les canaux TRPV5 et TRPV6 sont perméables au  $Mn^{2+}$  (Clapham *et al.*, 2001), la perméabilité au  $Mn^{2+}$  des canaux impliqués dans la signalisation calcique est recherchée. L'entrée du  $Mn^{2+}$  dans les cellules peut être suivie par l'induction d'un « quenching » de la fluorescence du Fura-2 (Merritt *et al.*, 1989). Ainsi, du  $Mn^{2+}$  est ajouté au milieu extracellulaire 10 s avant l'ajout des leucotoxines. Les mesures de l'intensité de fluorescence se font par spectrofluorimétrie à deux longueurs d'onde d'excitation de 340 et 360 nm. A 340 nm, l'intensité de la fluorescence du Fura-2 est augmentée suite à la fixation du  $Ca^{2+}$ , alors qu'elle diminue suite à la fixation du  $Mn^{2+}$ . A 360 nm, l'intensité de fluorescence est invariable vis-à-vis des variations de la concentration en  $Ca^{2+}$ , alors qu'elle diminue avec l'augmentation de la  $[Mn^{2+}]_i$ . En présence de HlgC-HlgB, l'entrée de  $Mn^{2+}$  dans les cellules induit une diminution de la fluorescence du Fura-2 à 360nm par quenching. Ainsi, HlgC-HlgB induit une entrée de  $Mn^{2+}$  dans les cellules montrant la participation de quelques canaux perméables au  $Mn^{2+}$  ce qui est en accord avec l'intervention de TRPV5 et TRPV6 dans la signalisation calcique de HlgC-HlgB.

### Comparaison avec la LPV, et comparaison avec d'autres modèles cellulaires

L'utilisation de différents inhibiteurs permet de montrer que suite à la fixation de HlgC-HlgB sur la membrane plasmique des neutrophiles, la libération des stocks réticulaires s'effectue par les IP3Rs suite à l'activation de la voie de l'IP3. La participation de cette voie est vérifiée par l'utilisation du 2-APB et du LY-294002 qui sont des inhibiteurs agissant au niveau des IP3Rs et de la PI3K. De plus, l'intervention de la voie des récepteurs de la ryanodine est écartée vue l'absence d'effet de la ryanodine et du GSH sur la variation de la  $[Ca^{2+}]_i$ . Cette libération du  $Ca^{2+}$  des stocks réticulaires est suivie par une entrée de  $Ca^{2+}$  extracellulaire. Les canaux membranaires impliqués dans cet influx de  $Ca^{2+}$  sont des SOCs, des TRPV et les TRPM2 qui sont inhibés respectivement par le 2-APB, le RR et le 8Br-cADPr. De plus, l'activation des neutrophiles permet également l'entrée de  $Mn^{2+}$  dans les cellules en impliquant certains canaux perméables aux ions  $Mn^{2+}$  comme TRPV5 et TRPV6 qui font partie de la famille des SOCs (Figure 3).

Cependant, les mêmes inhibiteurs n'ont pas les mêmes effets en présence d'autres leucotoxines bipartites



comme la LPV montrant que l'augmentation de la  $[Ca^{2+}]_i$  en réponse à la fixation des leucotoxines à la membrane des neutrophiles emprunte des voies différentes spécifiques à chaque leucotoxine. D'abord, les stocks intracellulaires sont libérés d'une manière plus complexe que pour HlgC-HlgB, puisque le 2-APB n'inhibe pas l'augmentation de la  $[Ca^{2+}]_i$ . En parallèle, l'intervention de la voie des récepteurs de la ryanodine a pu aussi être écartée puisque la ryanodine et le GSH n'ont pas d'effets en présence de la LPV. L'entrée du  $Ca^{2+}$  extracellulaire se fait par des canaux perméables au  $Mn^{2+}$ . Ces canaux sont des SOCs activés par la libération des stocks intracellulaires. Enfin, les canaux TRPV semblent intervenir dans le cas de la LPV, mais de façon moins importante qu'en présence de HlgC-HlgB, puisque le RR ne fait que ralentir la signalisation calcique.

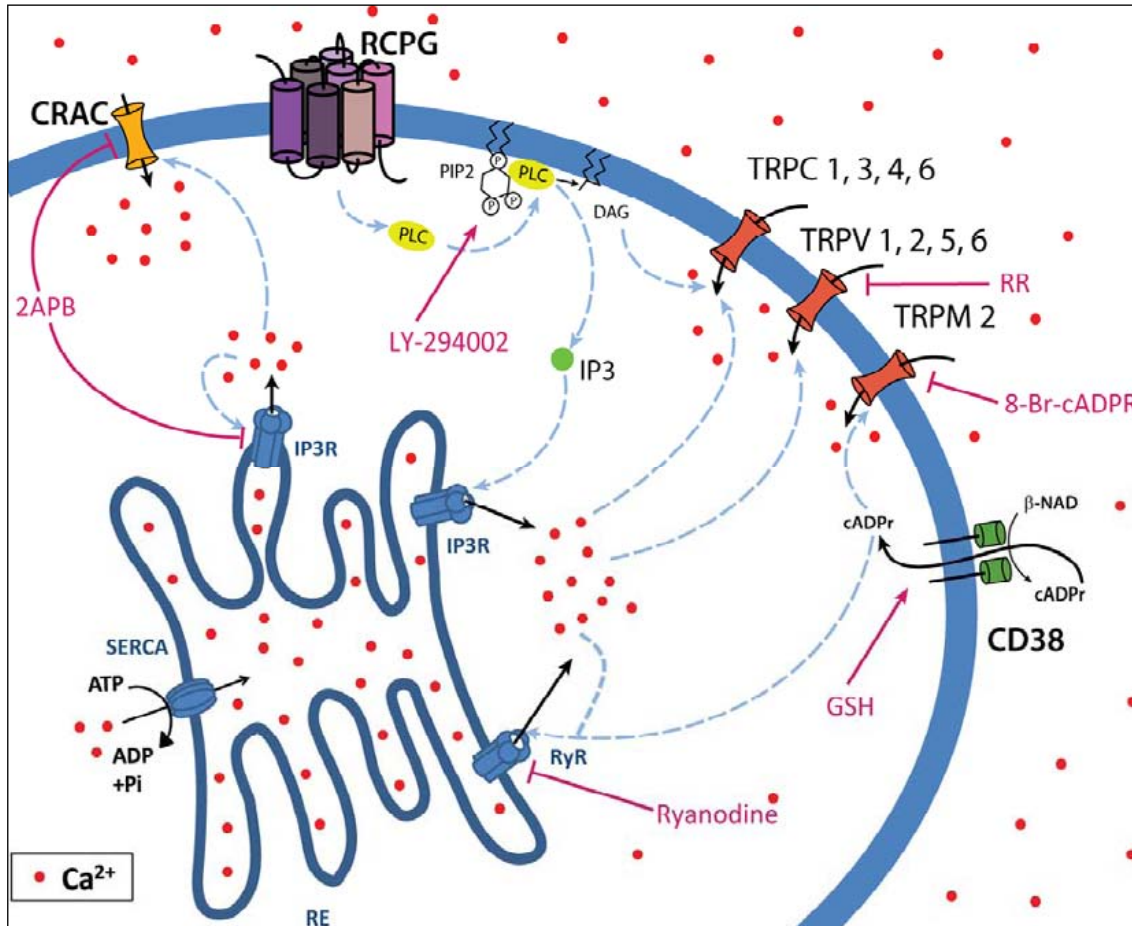

**Figure 3.** Voies de signalisations impliquées dans l'augmentation de la  $[Ca^{2+}]_i$  induite par les leucotoxines HlgC/HlgB. La ryanodine et le GSH agissant au niveau de la voie des RyRs montrent que cette voie n'est probablement pas impliquée dans cette signalisation calcique. Le 2-APB et le LY-294002 agissent au niveau de la voie de l'IP3 par inhibition des canaux IP3Rs et de la PI3K. Leurs effets sur l'augmentation de la  $[Ca^{2+}]_i$  montrent l'intervention de la voie de l'IP3 dans la signalisation calcique en réponse à HlgC/HlgB. L'utilisation du 2-APB, du RR et du 8Br-cADPr implique l'intervention des SOCs, TRPV et TRPM2 dans la signalisation calcique en réponse à HlgC/HlgB.

**Figure 3.** Signaling pathways involved in the increase in  $[Ca^{2+}]_i$  induced by HlgC/HlgB. Ryanodine and GSH, acting on RyRs pathway, show that this pathway is not involved in this calcium signaling. The 2-APB and LY-294002 act on IP3 pathway by inhibiting IP3R channels and PI3K. Their effects on the increase in  $[Ca^{2+}]_i$  shows the involvement of IP3 pathway in calcium signaling in response to HlgC/HlgB. The use of 2-APB, RR and 8Br-cADPr shows the involvement of SOCs, TRPV and TRPM2.

**Abbreviations:** 8Br-cADPr : 8-bromo-ADP-ribose cyclique, CD38 : Cluster of Differentiation 38, CRAC : Calcium Release-Activated  $Ca^{2+}$  channels, DAG : Diacylglycerol, IP3 : inositol triphosphate, IP3R : inositol triphosphate receptor, PI3K : Phosphoinositide 3-kinase, PIP2 : Phosphatidylinositol 4,5-bisphosphate, PLC : Phospholipase C, RCPG : GPCR or G Protein-Coupled Receptor, RE : ER or Endoplasmic Reticulum, RR : Ruthenium Red, RyR : Ryanodine Receptor, SERCA : Sarco/Endoplasmic Reticulum  $Ca^{2+}$ -ATPase, SOCs : Store Operated Channels, TRP : Transient Receptor Potential sub-family M, C and V, TPC : Two-Pore Channel).

De plus, une collaboration récente avec l'UPR 3212 – Institut des Neurosciences Cellulaires et Intégratives, Strasbourg - a permis de mettre en évidence que les neurones en grains du cervelet de rat sont une cible de HlgC-HlgB qui induit alors une augmentation triphasée du calcium intracellulaire et une libération de glutamate, mais sont peu sensibles à la LPV. Ces résultats sont conformes aux différences relevées au niveau des voies de signalisation activées par les deux leucotoxines. HlgC-HlgB pénètre les neurones *via* des vésicules d'endocytose sensibles à un antagoniste de la dynamine : le dynasore. Alors que la formation de pores à la surface de la membrane n'est pas évidente, l'internalisation de cette leucotoxine est responsable de l'augmentation du

calcium intracellulaire. Cet efflux cytoplasmique de calcium peut aussi être bloqué par la bafilomycine, un antagoniste de la pompe calcium-ATP dépendante et le Thio-NADP un antagoniste des canaux « Two Pore Channels » (TPC), d'abord identifiés dans le muscle cardiaque, puis sur des vésicules d'endocytose (Calcraft *et al.*, 2009). Ensuite, un second efflux calcique provient de la libération de calcium depuis les stocks endoréticulaires grâce aux RyRs et aux IP3Rs. Ce nouvel efflux calcique intracellulaire est certainement suffisant pour activer des canaux SOCs responsables du troisième signal calcique, le plus important.

## Conclusion

Nos résultats dévoilent un nouveau mécanisme de l'hémolysine gamma HlgC-HlgB en parallèle de la formation de pore. Cette leucotoxine active une voie de signalisation impliquant le récepteur à l'IP3, puis un canal calcique de type TRP, provoquant l'activation des neutrophiles et la sécrétion de granules contenant entre autres des facteurs pro-inflammatoires et des enzymes de dégradation. La maturation différentielle de certains précurseurs des granules, comme les chromogranines, peut engendrer une réponse par exemple soit antifongique, soit antibactérienne. La façon dont ces précurseurs vont être maturés peut soit profiter à l'hôte soit constituer un détournement du système par *S. aureus* pour dévier sa défense. Les produits de sécrétion doivent être analysés pour comprendre l'activation de la cellule, et comprendre le rôle de l'hémolysine gamma dans l'inflammation et plus globalement son impact sur le système immunitaire. L'autre point clef est le déclenchement du signal et la nature du récepteur de HlgC, pour lesquels nous créons actuellement des outils d'étude. Des résultats préliminaires d'imagerie confocale sur des neutrophiles et des neurones posent la question de l'endocytose de HlgC-HlgB et de l'origine intracellulaire du signal calcique.

**Remerciements.** M.T. et B.-J.L sont doctorants soutenus par la Fondation Berthe Fouassier, et par le Ministère de l'Enseignement Supérieur de la Recherche. Le Conseil Scientifique de l'Université de Strasbourg soutient ce projet.

## Références

- Arciola CR, Baldassarri L, Von Eiff C, *et al.* (2007) Prevalence of genes encoding for staphylococcal leukocidal toxins among clinical isolates of *Staphylococcus aureus* from implant orthopedic infections. *Int J Artif Organs* **30**: 792-797
- Baba-Moussa L, Werner S, Colin DA, *et al.* (1999) Discoupling the Ca(2+)-activation from the pore-forming function of the bi-component Pantone-Valentine leukocidin in human PMNs. *FEBS Lett* **461**: 280-286
- Brechard S, Tschirhart EJ (2008) Regulation of superoxide production in neutrophils: role of calcium influx. *J Leukoc Biol* **84**: 1223-1237
- Calcraft PJ, Ruas M, Pan Z, *et al.* (2009) NAADP mobilizes calcium from acidic organelles through two-pore channels. *Nature* **459**: 596-600
- Carpenter CL, Duckworth BC, Auger KR, *et al.* (1990) Purification and characterization of phosphoinositide 3-kinase from rat liver. *J Biol Chem* **265**: 19704-19711
- Caterina MJ, Schumacher MA, Tominaga M, *et al.* (1997) The capsaicin receptor: a heat-activated ion channel in the pain pathway. *Nature* **389**: 816-824
- Clapham DE, Runnels LW, Strubing C (2001) The TRP ion channel family. *Nat Rev Neurosci* **2**: 387-396
- Clark AJ, Petty HR (2005) Differential intracellular distributions of inositol trisphosphate and ryanodine receptors within and among hematopoietic cells. *J Histochem Cytochem* **53**: 913-916
- Colin DA, Mazurier I, Sire S, Finck-Barbançon V (1994) Interaction of the 2 Components of Leukocidin from *Staphylococcus aureus* with Human Polymorphonuclear Leukocyte Membranes - Sequential Binding and Subsequent Activation. *Infect Immun* **62**: 3184-3188
- Colin DA, Monteil H (2003) Control of the oxidative burst of human neutrophils by staphylococcal leukotoxins. *Infect Immun* **71**: 3724-3729
- Cooney J, Kienle Z, Foster TJ, O'Toole PW (1993) The gamma-hemolysin locus of *Staphylococcus aureus* comprises three linked genes, two of which are identical to the genes for the F and S components of leukocidin. *Infect Immun* **61**: 768-771
- den Dekker E, Hoenderop JG, Nilius B, Bindels RJ (2003) The epithelial calcium channels, TRPV5 & TRPV6: from identification towards regulation. *Cell Calcium* **33**: 497-507
- Dougherty RW, Godfrey PP, Hoyle PC, Putney JW, Jr., Freer RJ (1984) Secretagogue-induced phosphoinositide metabolism in human leucocytes. *Biochem J* **222**: 307-314
- Etienne J (2005) Pantone-Valentine leukocidin: a marker of severity for *Staphylococcus aureus* infection? *Clin Infect Dis* **41**: 591-593
- Ferreras M, Hoper F, Dalla Serra M, *et al.* (1998) The interaction of *Staphylococcus aureus* bi-component gamma-hemolysins and leukocidins with cells and lipid membranes. *Biochim Biophys Acta* **1414**: 108-126
- Finck-Barbançon V, Duportail G, Meunier O, Colin DA (1993) Pore formation by a two-component leukocidin from *Staphylococcus aureus* within the membrane of human polymorphonuclear leukocytes. *Biochim Biophys Acta* **1182**: 275-282
- Fruman DA, Gamache DA, Ernest MJ (1991) Changes in inositol 1,4,5-trisphosphate mass in agonist-stimulated human neutrophils. *Agents Actions* **34**: 16-19
- Gauduchon V, Werner S, Prévost G, Monteil H, Colin DA (2001) Flow cytometric determination of Pantone-Valentine leukocidin S component binding. *Infect Immun* **69**: 2390-2395
- Genestier AL, Michallet MC, Prévost G, *et al.* (2005) *Staphylococcus aureus* Pantone-Valentine leukocidin directly targets mitochondria and induces Bax-independent apoptosis of human neutrophils. *J Clin Invest* **115**: 3117-3127
- Girgis DO, Sloop GD, Reed JM, O'Callaghan RJ (2005) Effects of toxin production in a murine model of *Staphylococcus aureus* keratitis. *Invest Ophthalmol Vis Sci* **46**: 2064-2070
- Heiner I, Eisfeld J, Halaszovich CR, *et al.* (2003) Expression profile of the transient receptor potential (TRP) family in neutrophil granulocytes: evidence for currents through long TRP channel 2 induced by ADP-ribose and NAD. *Biochem J* **371**: 1045-1053

- Heiner I, Radukina N, Eisfeld J, Kuhn F, Luckhoff A (2005) Regulation of TRPM2 channels in neutrophil granulocytes by ADP-ribose: a promising pharmacological target. *Naunyn Schmiedebergs Arch Pharmacol* **371**: 325-333
- Hensler T, König B, Prévost G, *et al.* (1994) Leukotriene B4 generation and DNA fragmentation induced by leukocidin from *Staphylococcus aureus*: protective role of granulocyte-macrophage colony-stimulating factor (GM-CSF) and G-CSF for human neutrophils. *Infect Immun* **62**: 2529-2535
- Hoenderop JG, Voets T, Hoefs S, *et al.* (2003) Homo- and heterotetrameric architecture of the epithelial Ca<sup>2+</sup> channels TRPV5 and TRPV6. *EMBO J* **22**: 776-785
- Itagaki K, Kannan KB, Singh BB, Hauser CJ (2004) Cytoskeletal reorganization internalizes multiple transient receptor potential channels and blocks calcium entry into human neutrophils. *J Immunol* **172**: 601-607
- Iwasaki H, Mori Y, Hara Y, *et al.* (2001) 2-Aminoethoxydiphenyl borate (2-APB) inhibits capacitative calcium entry independently of the function of inositol 1,4,5-trisphosphate receptors. *Receptors Channels* **7**: 429-439
- Joubert O, Viero G, Keller D, *et al.* (2006) Engineered covalent leucotoxin heterodimers form functional pores: insights into S-F interactions. *Biochem J* **396**: 381-389
- Kloft N, Busch T, Neukirch C, *et al.* (2009) Pore-forming toxins activate MAPK p38 by causing loss of cellular potassium. *Biochem Biophys Res Commun* **385**: 503-506
- Köller M, Hensler T, König B, *et al.* (1993) Induction of heat-shock proteins by bacterial toxins, lipid mediators and cytokines in human leukocytes. *Zentralbl Bakteriol* **278**: 365-376
- König B, Prévost G, Piémont Y, König W (1995) Effects of *Staphylococcus aureus* leukocidins on inflammatory mediator release from human granulocytes. *J Infect Dis* **171**: 607-613
- Lee HC (2001) Physiological functions of cyclic ADP-ribose and NAADP as calcium messengers. *Annu Rev Pharmacol Toxicol* **41**: 317-345
- Marasco WA, Phan SH, Krutzsch H, *et al.* (1984) Purification and identification of formyl-methionyl-leucyl-phenylalanine as the major peptide neutrophil chemotactic factor produced by *Escherichia coli*. *J Biol Chem* **259**: 5430-5439
- Maruyama T, Kanaji T, Nakade S, Kanno T, Mikoshiba K (1997) 2APB, 2-aminoethoxydiphenyl borate, a membrane-penetrable modulator of Ins(1,4,5)P<sub>3</sub>-induced Ca<sup>2+</sup> release. *J Biochem* **122**: 498-505
- McMeeke SR, Dransfield I, Rossi AG, Haslett C, Walker TR (2006) E-selectin permits communication between PAF receptors and TRPC channels in human neutrophils. *Blood* **107**: 4938-4945
- Menteyne A, Burdakov A, Charpentier G, *et al.* (2006) Generation of specific Ca<sup>2+</sup> signals from Ca<sup>2+</sup> stores and endocytosis by differential coupling to messengers. *Curr Biol* **16**: 1931-1937
- Merritt JE, Jacob R, Hallam TJ (1989) Use of manganese to discriminate between calcium influx and mobilization from internal stores in stimulated human neutrophils. *J Biol Chem* **264**: 1522-1527
- Meunier O, Ferreras M, Supersac G, *et al.* (1997) A predicted beta-sheet from class S components of staphylococcal gamma-hemolysin is essential for the secondary interaction of the class F component. *Biochim Biophys Acta - Biomembranes* **1326**: 275-286
- Miles G, Movileanu L, Bayley H (2002) Subunit composition of a bicomponent toxin: staphylococcal leukocidin forms an octameric transmembrane pore. *Protein Sci* **11**: 894-902
- Milosevic I, Sorensen JB, Lang T, *et al.* (2005) Plasmalemmal phosphatidylinositol-4,5-bisphosphate level regulates the releasable stores via S-nitrosylation in chromaffin cells. *J Neurosci* **25**: 2557-2565
- Mooney C, Keenan J, Munster D, *et al.* (1991) Neutrophil activation by *Helicobacter pylori*. *Gut* **32**: 853-857
- Morita K, Saida M, Morioka N, *et al.* (2008) Cyclic ADP-ribose mediates formyl methionyl leucyl phenylalanine (fMLP)-induced intracellular Ca(2+) rise and migration of human neutrophils. *J Pharmacol Sci* **106**: 492-504
- Nariya H, Kamio Y (1995) Identification of the essential regions for LukS- and H gamma II-specific functions of staphylococcal leukocidin and gamma-hemolysin. *Biosci Biotechnol Biochem* **59**: 1603-1604
- Nishiyama A, Kaneko J, Harata M, Kamio Y (2006) Assembly of staphylococcal leukocidin into a pore-forming oligomer on detergent-resistant membrane microdomains, lipid rafts, in human polymorphonuclear leukocytes. *Biosci Biotechnol Biochem* **70**: 1300-1307
- Noda M, Kato I, Hirayama T, Matsuda F (1980) Fixation and inactivation of staphylococcal leukocidin by phosphatidylcholine and ganglioside GM1 in rabbit polymorphonuclear leukocytes. *Infect Immun* **29**: 678-684
- Pan L, Zhang X, Song K, Wu X, Xu J (2008) Exogenous nitric oxide-induced release of calcium from intracellular IP3 receptor-sensitive stores via S-nitrosylation in respiratory burst-dependent neutrophils. *Biochem Biophys Res Commun* **377**: 1320-1325
- Partida-Sanchez S, Cockayne DA, Monard S, *et al.* (2001) Cyclic ADP-ribose production by CD38 regulates intracellular calcium release, extracellular calcium influx and chemotaxis in neutrophils and is required for bacterial clearance *in vivo*. *Nat Med* **7**: 1209-1216
- Peppiatt CM, Collins TJ, Mackenzie L, *et al.* (2003) 2-Aminoethoxydiphenyl borate (2-APB) antagonises inositol 1,4,5-trisphosphate-induced calcium release, inhibits calcium pumps and has a use-dependent and slowly reversible action on store-operated calcium entry channels. *Cell Calcium* **34**: 97-108
- Perraud AL, Fleig A, Dunn CA, *et al.* (2001) ADP-ribose gating of the calcium-permeable LTRPC2 channel revealed by Nudix motif homology. *Nature* **411**: 595-599
- Phillippe M, Basa A (1996) The effects of ruthenium red, an inhibitor of calcium-induced calcium release, on phasic myometrial contractions. *Biochem Biophys Res Commun* **221**: 656-661
- Potrich C, Bastiani H, Colin DA, *et al.* (2009) The influence of membrane lipids in *Staphylococcus aureus* gamma-hemolysin pore formation. *J Membr Biol* **227**: 13-24
- Prévost G, Couppié P, Prévost P, *et al.* (1995a) Epidemiological data on *Staphylococcus aureus* strains producing synergohymenotropic toxins. *J Med Microbiol* **42**: 237-245
- Prévost G, Cribier B, Couppié P, *et al.* (1995b) Panton-Valentine leukocidin and gamma-hemolysin from *Staphylococcus aureus* ATCC 49775 are encoded by distinct genetic loci and have different biological activities. *Infect Immun* **63**: 4121-4129
- Staali L, Monteil H, Colin DA (1998) The staphylococcal pore-forming leukotoxins open Ca<sup>2+</sup> channels in the membrane of human polymorphonuclear neutrophils. *J Membr Biol* **162**: 209-216

- Sugawara-Tomita N, Tomita T, Kamio Y (2002) Stochastic assembly of two-component staphylococcal gamma-hemolysin into heteroheptameric transmembrane pores with alternate subunit arrangements in ratios of 3:4 and 4:3. *J Bacteriol* **184**: 4747-4756
- Sugawara N, Tomita T, Kamio Y (1997) Assembly of *Staphylococcus aureus* gamma-hemolysin into a pore-forming ring-shaped complex on the surface of human erythrocytes. *FEBS Lett* **410**: 333-337
- Supersac G, Piémont Y, Kubina M, Prévost G, Foster TJ (1998) Assessment of the role of gamma-toxin in experimental endophthalmitis using a *hlg*-deficient mutant of *Staphylococcus aureus*. *Microb Pathog* **24**: 241-251
- Szallasi A, Blumberg PM (1999) Vanilloid (Capsaicin) receptors and mechanisms. *Pharmacol Rev* **51**: 159-212
- Vlahos CJ, Matter WF, Hui KY, Brown RF (1994) A specific inhibitor of phosphatidylinositol 3-kinase, 2-(4-morpholinyl)-8-phenyl-4H-1-benzopyran-4-one (LY294002). *J Biol Chem* **269**: 5241-5248
- von Eiff C, Friedrich AW, Peters G, Becker K (2004) Prevalence of genes encoding for members of the staphylococcal leukotoxin family among clinical isolates of *Staphylococcus aureus*. *Diagn Microbiol Infect Dis* **49**: 157-162
- Walev I, Vollmer P, Palmer M, Bhakdi S, Rose-John S (1996) Pore-forming toxins trigger shedding of receptors for interleukin 6 and lipopolysaccharide. *Proc Natl Acad Sci USA* **93**: 7882-7887
- Werner S, Colin DA, Coraiola M, et al. (2002) Retrieving biological activity from LukF-PV mutants combined with different S components implies compatibility between the stem domains of these staphylococcal bicomponent leucotoxins. *Infect Immun* **70**: 1310-1318
- Zocchi E, Usai C, Guida L, et al. (1999) Ligand-induced internalization of CD38 results in intracellular Ca<sup>2+</sup> mobilization: role of NAD<sup>+</sup> transport across cell membranes. *FASEB J* **13**: 273-283
-



## **A new system for expressing recombinant animal toxins in *E. coli* ?**

Badreddine DOUZI<sup>1</sup>, Arie GEERLOF<sup>2</sup>, Hervé DARBON<sup>1</sup>, Nicolas GILLES<sup>3</sup>,  
Pascale MARCHOT<sup>4</sup>, Renaud VINCENTELLI<sup>1\*</sup>

<sup>1</sup> Architecture et Fonction des Macromolécules Biologiques (AFMB), UMR 6098 CNRS/ Universités d'Aix-Marseille I-II, Campus de Luminy, F-13288 Marseille cedex 9, France ; <sup>2</sup> Helmholtz Zentrum München, Institute of Structural Biology Building 43b, Ingolstädter Landstraße 1, D-85764 München, Germany ; <sup>3</sup> IBiTeCS, SIMOPRO, CEA, Gif sur Yvette, France ; <sup>4</sup> ToxCiM, Centre de Recherche en Neurobiologie-Neurophysiologie de Marseille (CRN2M), CNRS/Universités d'Aix-Marseille I-II-III, Faculté de Médecine - Secteur Nord, F-13344 Marseille cedex 15, France

\* Corresponding author ; Tel : +33 (0)4 9182 5583 ; Fax : +33 (0)4 9126 6720 ;  
E-mail : [renaud.vincentelli@afmb.univ-mrs.fr](mailto:renaud.vincentelli@afmb.univ-mrs.fr)

---

### **Abstract**

Recombinant expression in bacteria remains the most “high yield, low cost” means for production of disulfide-rich peptides. Unfortunately, in most cases a long process of renaturation is necessary to obtain properly folded and fully active toxins. Here we describe a method that we have set up and successfully validated for the production of active toxins from animal venoms in *E. coli*.

### **Un nouveau système pour exprimer des toxines animales recombinantes dans *E. coli* ?**

L'expression dans la bactérie de protéines recombinantes riches en ponts disulfure reste le moyen le plus efficace et le plus économique. Mais dans la plupart des cas un long processus de renaturation est nécessaire pour obtenir la forme active. Nous décrivons dans cet article une méthode validée qui permet de produire des toxines actives directement dans *E. coli*.

**Keywords :** Bacteria, chaperone, folding, pharmacological activity, toxin.

---

## **Introduction**

Disulfide-rich peptide toxins (1-8 kDa) that are isolated from various animal venoms and are active as receptor antagonists or ion channel blockers (amongst other possible functions) represent useful molecular tools for the study of their respective receptors (Ménez, 1998). However, these studies can be hampered by the limited amount of venom available (depending on the animal species) or of a toxin available in a venom along with the limited number of natural mutants, all features that can prompt toxinologists into turning to synthesis or recombinant production of toxins.

Milligram amounts of a toxin polypeptide can be easily obtained by solid-phase peptide synthesis, but the protein is not functional and has to be renaturated into its folded, active form (Moroder *et al.*, 2005). However, refolding protocols can be long and difficult to be setup and they usually end up with limited purification yields (Lecomte *et al.*, 1998). Heterologous expression as inclusion bodies in the reducing environment of the *E. coli* cytoplasm is very efficient but it also requires a downstream process to refold and purify the toxin (Drevet *et al.*, 1997 ; Quinton *et al.*, 2010). Alternatively, expression in the oxidizing environment of the periplasm, most often attempted in the form of a fusion protein, can lead to properly folded toxins but with lower production levels (Gillet *et al.*, 1992). In turn, expression in yeast can yield reasonable amounts of properly folded toxin but it involves lengthy selection of suitable clones (Park *et al.*, 2008). Finally, expression as secreted soluble proteins from mammalian cells also leads to properly folded toxins, but a time- and cost-consuming procedure of clonal selection is required to get stable cell lines and achieve suitable production levels (Marchot *et al.*, 1997). These caveats are even more critical when the toxin of interest is folded by more than three disulfide bridges (*i.e.* when 10-20% of the residues are half-cystines). Finally, none of these strategies are compatible with the production of banks of toxins or of various mutants for analysis of structure/function relationships.

Bacteria would remain the most effective hosts for “high yield, low cost” production of disulfide-rich toxins as long as proper folding into a fully active final product could be ascertained. Herein we describe a method that we have set up and successfully validated for the production of active disulfide-rich toxins from animal venoms in *E. coli*.

## **A new expression system**

To cope with the few thousand proteins that have been tackled in our lab (AFMB), we have set up an efficient

analytical high throughput expression screening pipeline (Vincentelli *et al.*, 2003; Gräslund *et al.*, 2008). These protocols are based on a multi-factorial combination of strains, culture conditions and solubilisation tags (Berrow *et al.*, 2006) and allow the expression screening of up to hundred cultures in parallel. This helps, on average, to increase by several fold the solubility level of most of the recombinant proteins that have been assayed for expression. Furthermore, this leads to a higher number of different proteins expressed in a soluble form than more traditional protocols (Vincentelli and Cambillau, in preparation). In the last couple of years, in collaboration with our NMR department we have tried these protocols for expression of a few toxins in *E. coli*. Like most groups, we could express the toxins as inclusion bodies or in a soluble but misfolded form, but we failed to produce functional toxins *in vivo* in all cases but one !

In the periplasm, correct oxidation and isomerization of the disulfide bridges mainly rely on the chaperones DsbA and DsbC (Nakamoto and Bardwell, 2004; Vertommen *et al.*, 2008; De Marco, 2009). In fact this mechanism has been known for decades (Figure 1), but very few publications are available on the effect of these chaperones on the correct folding of cysteine-rich proteins directly in *E. coli*.

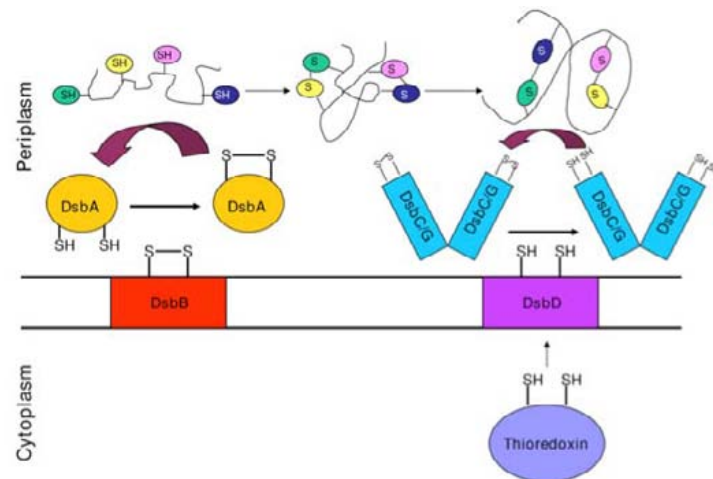

**Figure 1.** Dsb-dependent protein oxidation and isomerization in the bacterial periplasm. DsbA couples consecutive cysteines providing the disulfide bond and is re-charged by the inner membrane DsbB. Incorrect disulfides are scrambled by DsbC and DsbG. These isomerases are kept reduced by the inner membrane DsbD that, in turn, is reduced by the cytoplasmic thioredoxin. Figure reproduced from De Marco (2009).

**Figure 1.** Oxydation et isomérisation des protéines dans le périplasmе bactérien par le système Dsb. DsbA forme un pont disulfure entre les cystéines consécutives et est rechargée par la protéine de la membrane interne DsbB. Les ponts disulfures incorrects sont ré-arrangés par DsbC et DsbG. Ces isomérases sont réduites par la protéine de la membrane interne DsbD qui, en retour, est réduite par la thiorédoxine cytoplasmique. Figure reproduite depuis De Marco (2009).

Our cloning strategy, based on the Gateway® Recombination Cloning Technology (Invitrogen), allows us, once a given protein is cloned in the pENTR vector, to subclone it into various destination vectors using high throughput methods (Vincentelli *et al.*, 2003). The availability of the high throughput pipeline and of custom made vectors with His-tagged DsbA or DsbC fusion partners (Figure 2) prompted us to benchmark the effect of their co-expression on the correct folding of disulfide-rich toxins in the *E. coli* cytoplasm or periplasm. To this end, we selected 14 toxin candidates with a variable number of disulfides and distinctive structural folds and subcloned them as His-tagged fusion proteins with DsbA or DsbC, each with or without a signal peptide for periplasmic *versus* cytoplasmic addressing.



**Figure 2.** Vector for the expression of toxins with a fusion partner in *E. coli*. Four custom-made Gateway® destination vectors were designed for the expression of toxins (« target ») fused with DsbA or DsbC (« Fusion tag\* ») and with or without a signal peptide (purple box). Protein cloning in these vectors used the recombination sites attB1 and attB2. The full length fusion protein is purified by Ni-chelation chromatography, then the toxin is separated from the 6xHis-tagged Dsb protein by TEV protease cleavage at the « TEV » site.

**Figure 2.** Vecteur pour l'expression de toxines sous forme de protéines de fusion dans *E. coli*. Quatre vecteurs de destination Gateway® spécifiques ont été créés pour l'expression de toxines (« target ») en fusion avec DsbA et DsbC (« fusion tag\* »), et avec ou sans peptide signal (carré violet). Le clonage des protéines utilise les sites de recombinaison attB1 and attB2. Les protéines de fusion sont purifiées par chromatographie de Ni-chélation, puis la toxine est séparée de la 6xHis-Dsb par clivage par la protéase TEV au site « TEV ».

After a single expression trial in our best expression combination of strain and medium (Vincentelli and Cambillau, in preparation), we purified the soluble fraction by Ni-affinity chromatography and analyzed the level of purified protein by SDS-PAGE with Coomassie staining (Figure 3). The result obtained on these toxins as Dsb fusions was compared to those obtained on the same toxins simply fused to a His-tagged ZZ or thioredoxin partner (Vincentelli and Cambillau, in preparation).

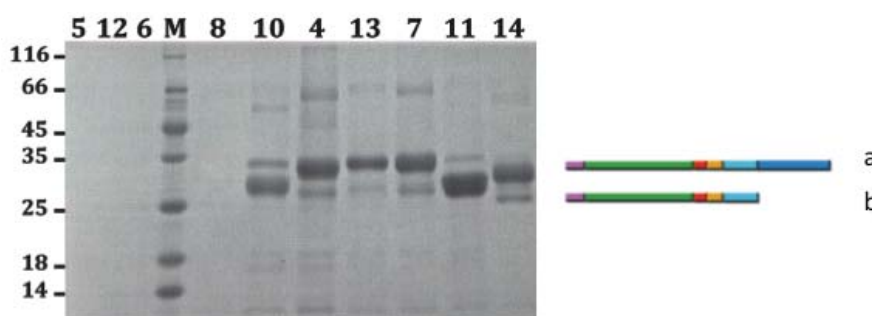

**Figure 3.** SDS-PAGE analysis of the expression level for soluble proteins and of the purification fractions of various toxins fused to DsbC. The full-length protein (a) consists of DsbC-6xHis-Tev site (27 kDa) followed by the toxin (from 1.7 to 7.8 kDa). M: molecular weight markers (kDa values on the left). Numbers 4-14 denote the various toxins analyzed (cf. Figure 4). The proteins labelled 5, 6, 8, 12 are not soluble in these conditions. The other proteins sometimes behave as two populations in the elution fraction: the upper band population is the full-length fusion protein (a), while the lower band population is 6xHis-DsbC (b), as assessed by binding on the Ni-gel, western blot with an anti-6xHis antibody and MALDI-TOF mass spectrometry. The presence of this population suggests that in these expression conditions some of the fusion proteins carried a toxin that was not properly folded and was degraded by the *E. coli* quality control process; only the chaperone part is properly folded and can be purified. For some other toxins or expression conditions this band is weak or absent. Proteins 10 and 11 would need other culture conditions to increase the proportion of the full-length fusion. Proteins 4, 7, 13, 14 could be scaled up directly in the initial expression conditions.

**Figure 3.** Analyse par SDS-PAGE du niveau de protéines solubles et des fractions de purification analytique des toxines en fusion avec DsbC. La protéine fusion entière (a) contient la séquence DsbC-6xHis-site TEV (27 kDa) suivie de la toxine (de 1.7 à 7.8 kDa). M : marqueurs de masse moléculaire (valeurs en kDa à gauche). Les nombres 4-14 représentent les différentes toxines testées sur ce gel (cf. Figure 4). Les protéines 5, 6, 8, 12 ne sont pas solubles dans ces conditions. Les autres protéines présentent parfois deux populations : la bande supérieure est la protéine fusion d'intérêt (a), la bande inférieure est la protéine 6xHis-DsbC seule, comme attesté par rétention sur gel de Ni-chélation, révélation par western blot avec un anticorps anti-6xHis et spectrométrie de masse MALDI-TOF (b). La présence de cette bande suggère que dans ces conditions d'expression une certaine proportion de la protéine de fusion portait une toxine incorrectement repliée ayant été dégradée par le mécanisme de contrôle qualité de *E. coli* ; seule la partie chaperone est correctement repliée et purifiée (b). Pour d'autres toxines ou conditions d'expression cette bande est minoritaire ou absente. Les protéines 10 et 11 devraient être produites dans d'autres conditions de culture pour augmenter la proportion de protéines entières. Les protéines 4, 7, 13, 14 peuvent être produites directement dans les conditions de ce test initial.

When the initial analytical results were promising (the cases where pure fusion proteins were found in the elution), we scaled up the production of one/two toxin(s) per structural family (three-fingered, alpha/beta, inhibitor cysteine knot (ICK), and a toxin with an unknown fold with four disulfides). Then, after purification and release of the toxins by TEV protease cleavage (Vincentelli *et al.*, 2003) we checked that the proteins were in a native form by NMR recording and/or activity assays. An overall result chart is displayed in Figure 4.

Name	Fold	# Cys	Analytical scale (4 ml)			Production scale (1 litre)				
			ZZ	TRX	DsbA/DsbC	fusion purified	Tev cleavage	toxin purified	Mass Spec	functional test
1	3 fingers	8			All, Dsb C used					
2	3 fingers	8			DsbC only					
3	3 fingers	8			DsbA, DsbC					
4	3 fingers	8			DsbC only					
5	3 fingers	10								
6	3 fingers	8			DsbA only					
7	3 fingers	8			All, Dsb C used					
8	ICK	6								
9	ICK	6		folded, TRX for scale up	all					
10	ICK	6			DsbC only					
11	alpha/beta	8			DsbC only					weak activity
12	Kunitz	6								
13	unknown	8			DsbA, DsbC					
14	unknown	8		unfolded	all, Dsb A used					

soluble
Not soluble
Not done
Partial cleavage
structure OK

**These proteins have no known function but NMR data show that they are correctly folded.**

**Figure 4.** Result chart of Dsb use of as fusion partner. This table summarizes the level of soluble expression estimated by SDS-PAGE after purification at the analytical scale on 14 toxins (numbered 1-14) expressed as Dsb, ZZ or TRX fusion proteins. 11/14 Dsb fusions are soluble, 0/11 ZZ fusions and 2/2 TRX fusions (but only one is folded). Of these soluble fusions, we selected those 5 that resulted in the highest yield (3 DsbC, 1 DsbA, 1 TRX) for a 1 L production. In all cases we could purify the fusions, cleave off the Dsb or TRX tags and purify the final toxins, although with variable yields. Disulfide formation was assessed by mass spectrometry. When an activity assay was available the proteins were found to be active. In the case of proteins with unknown function an NMR spectrum confirmed that they were folded.

**Figure 4.** Tableau récapitulatif de l'utilisation des fusions Dsb. Ce tableau résume le niveau d'expression estimé par SDS-PAGE après purification à l'échelle analytique de 14 toxines (numérotées 1-14) exprimées sous forme de protéines de fusion Dsb, ZZ ou TRX. 11/14 fusions Dsb sont solubles, 0/11 fusions ZZ et 2/2 fusions TRX (mais une seule est repliée). Sur ces 11 fusions solubles nous avons sélectionné les 5 donnant le plus de protéine soluble (3 DsbC, 1 DsbA, 1 TRX) pour une production de 1 L. Les fusions ont été purifiées, le tag TRX ou Dsb enlevé et toutes les toxines purifiées, bien qu'avec des rendements variables. La présence des ponts disulfure a été confirmée par spectrométrie de masse. Lorsqu'un test d'activité était disponible l'activité des toxines a été confirmée. Dans le cas de protéines de fonction inconnue un spectre RMN a confirmé que les protéines étaient structurées.



In most cases we could confirm, using NMR or pharmacological tests, that the proteins were correctly folded at the production level. These activities were sometimes low but these tests were made without optimization of the expression and purification parameters (strains, medium, lysis buffer, chromatography buffers ...). Further investigations may lead to increase the final yields.

## Conclusion

These results, although preliminary, suggest that the use of a redox DsbA and/or DsbC fusion partner as an alternative to *in vitro* refolding protocols may provide toxinologists with a suitable mean for "high yield / low cost" expression of properly folded disulfide-rich toxins in *E. coli*. Assaying various toxin families with documented folding caveats and diverse fusion partners will help us setting up an efficient pipeline for high throughput and efficient toxin production.

**Acknowledgements.** We are grateful to Julie Abdat (AFMB, Marseille) for assistance in plasmid construction and primary expression assays, to Marie-France Martin-Eauclaire, Claire Debarnot and Sandrine Conrod (CRN2M, Marseille) for assistance in expression, purification and activity assays, and to Denis Servent (CEA, Gif sur Yvette) for fruitful discussion.

## References

- Berrow NS, Büssov K, Coutard B, Diprose J, Ekberg M, Folkers GE, Levy N, Lieu V, Owens RJ, Peleg Y, Pinaglia C, Quevillon-Cheruel S, Salim L, Scheich C, Vincentelli R\*, Busso D (2006) Recombinant protein expression and solubility screening in *Escherichia coli*: a comparative study. *Acta Crystallogr D Biol Crystallogr* **62**: 1218-1226
- De Marco A (2009) Strategies for successful recombinant expression of disulfide bond-dependent proteins in *Escherichia coli*. *Microb Cell Fact* **8**: 26
- Drevet P, Lemaire C, Gasparini S, Zinn-Justin S, Lajeunesse E, Ducancel F, Pinkasfeld S, Courçon M, Tremeau O, Boulain JC, Ménez A (1997) High-level production and isotope labeling of snake neurotoxins, disulfide-rich proteins. *Protein Expr Purif* **10**: 293-300
- Gillet D, Ducancel F, Pradel E, Léonetti M, Ménez A, Boulain JC (1992) Insertion of a disulfide-containing neurotoxin into *E. coli* alkaline phosphatase: the hybrid retains both biological activities. *Protein Eng* **5**: 273-278
- Gräslund S, Nordlund P, Weigelt J, Hallberg BM, Bray J, Gileadi O, Knapp S, Oppermann U, Arrowsmith C, Hui R, Ming J, dhe-Paganon S, Park HW, Savchenko A, Yee A, Edwards A, Vincentelli R, Cambillau C, Kim R, Kim SH, Rao Z, Shi Y, Terwilliger TC, Kim CY, Hung LW, Waldo GS, Peleg Y, Albeck S, Unger T, Dym O, Prilusky J, Sussman JL, Stevens RC, Lesley SA, Wilson IA, Joachimiak A, Collart F, Dementieva I, Donnelly MI, Eschenfeldt WH, Kim Y, Stols L, Wu R, Zhou M, Burley SK, Emtage JS, Sauder JM, Thompson D, Bain K, Luz J, Gheyi T, Zhang F, Atwell S, Almo SC, Bonanno JB, Fiser A, Swaminathan S, Studier FW, Chance MR, Sali A, Acton TB, Xiao R, Zhao L, Ma LC, Hunt JF, Tong L, Cunningham K, Inouye M, Anderson S, Janjua H, Shastry R, Ho CK, Wang D, Wang H, Jiang M, Montelione GT, Stuart DI, Owens RJ, Daenke S, Schütz A, Heinemann U, Yokoyama S, Büssov K, Gunsalus KC (2008) Protein production and purification. *Nat Methods* **5**:135-146
- Lecomte C, Sabatier JM, Van Rietschoten J, Rochat H (1998) Synthetic peptides as tools to investigate the structure and pharmacology of potassium channel-acting short-chain scorpion toxins. *Biochimie* **80**: 151-154
- Marchot P, Prowse CN, Kanter J, Camp S, Ackermann EJ, Radić Z, Bougis PE, Taylor P (1997) Expression and inhibitory activity of mutants of fasciculins, a peptidic acetylcholinesterase inhibitor from mamba venom. *J Biol Chem* **272**: 3502-3510
- Ménez A (1998) Functional architectures of animal toxins: a clue to drug design? *Toxicon* **36**: 1557-1572
- Moroder L, Musiol HJ, Götz M, Renner C (2005) Synthesis of single- and multiple-stranded cysteine-rich peptides. *Biopolymers* **80**: 85-97
- Nakamoto H, Bardwell JC (2004) Catalysis of disulfide bond formation and isomerization in the *Escherichia coli* periplasm. *Biochim Biophys Acta* **1694**: 111-119
- Quinton L, Girard E, Maiga A, Rekik M, Lluet P, Masuyer G, Larregola M, Marquer C, Ciolek J, Magnin T, Wagner R, Molgó J, Thai R, Fruchart-Gaillard C, Mourier G, Chamot-Rooke J, Ménez A, Palea S, Servent D, Gilles N (2010) Isolation and pharmacological characterization of AdTx1, a natural peptide displaying specific insurmountable antagonism of the alpha1A-adrenoceptor. *Br J Pharmacol* **159**: 316-325
- Park SP, Kim BM, Koo JY, Cho H, Lee CH, Kim M, Na HS, Oh U (2008) A tarantula spider toxin, GsMTx4, reduces mechanical and neuropathic pain. *Pain* **137**: 208-217
- Vertommen D, Depuydt M, Pan J, Leverrier P, Knoops L, Szikora JP, Messens J, Bardwell JC, Collet JF (2008) The disulphide isomerase DsbC cooperates with the oxidase DsbA in a DsbD-independent manner. *Mol Microbiol* **67**: 336-349
- Vincentelli R, Bignon C, Gruez A, Cnaan S, Sulzenbacher G, Tegoni M, Campanacci V, Cambillau C (2003) Medium-scale structural genomics: strategies for protein expression and crystallization. *Acc Chem Res* **36**: 165-172

## ***Toxines issues de bactéries, cyanobactéries, champignons, organismes marins et serpents ciblant les cholinestérases : utilisation thérapeutique potentielle dans le traitement de la maladie d'Alzheimer ?***

Nicole PAGES<sup>1\*</sup>, Françoise GOUDEY-PERRIERE<sup>2</sup>, Patrick BRETON<sup>3</sup>

<sup>1</sup> Laboratoire de Toxicologie, Faculté de Pharmacie, Université de Strasbourg, F-67400 Illkirch, France ;

<sup>2</sup> Laboratoire de Biologie animale, Faculté de Pharmacie, 3 rue Jean Baptiste Clément, F-92296 Châtenay-Malabry, France ; <sup>3</sup> Centre d'Etudes du Bouchet, F-91710 Vert le Petit, France

\* Auteur correspondant ; Fax : (0)1 6019 0131 ; Courriel : [nicole.pages4@hotmail.fr](mailto:nicole.pages4@hotmail.fr)

---

### **Résumé**

*L'administration d'inhibiteurs de l'acétylcholinestérase (AChEI) à des patients encore modérément atteints de la maladie d'Alzheimer (AD) peut retarder l'évolution de la maladie et faciliter les processus de mémorisation. Leur effet est modeste mais réel. Cependant, les médicaments peuvent provoquer des effets secondaires importants et devenir progressivement moins efficaces. C'est pourquoi la recherche de l'inhibiteur idéal se poursuit. En complément de nos revues précédentes sur les composés issus de plantes (Pages et al., 2009b,c), le présent article récapitule les principaux produits naturels possédant une activité d'AChEI, synthétisés par des bactéries, cyanobactéries, algues, champignons, invertébrés marins et Vertébrés. Ces composés ou leurs dérivés de synthèse pourraient servir dans le futur à traiter divers types de désordres cognitifs liés à un déficit cholinergique, dont la maladie d'Alzheimer.*

### ***Toxins from bacteriae, cyanobacteriae, fungi, marine organisms and snake venoms targeting cholinesterases : a potential therapeutic use in Alzheimer's disease***

*It is recognized that the administration of acetylcholinesterase inhibitors (AChEI) to early stage Alzheimer patients may delay the evolution of the disease and facilitate the memory processes. The effect is mild but recognized. However, therapeutic drugs can potentially cause major unwanted side effects and may become progressively inefficient. So the search for the ideal inhibitor continues. In complement to our previous reviews on compounds isolated from plants (Pages et al., 2009b,c), the present paper summarises natural products from bacteriae, cyanobacteriae, algae, fungi, marine invertebrates or Vertebrates acting as AChEI and that could be used in the next future in the treatment of various forms of cognitive disorders involving a cholinergic deficit, including Alzheimer's disease.*

**Keywords :** *Alzheimer's disease, bacteriae, cholinesterase inhibitor, cyanobacteriae, fungi, marine organism, snake, toxin.*

---

### **Introduction**

L'un des rôles majeurs de l'acétylcholine (ACh) dans le cerveau est de régulariser le fonctionnement cognitif. Un déficit en ACh, notamment dans le cerveau antéro-basal, est une caractéristique de la maladie d'Alzheimer (*Alzheimer's disease* ou AD) (Coyle *et al.*, 1983; Teipel *et al.*, 2005). L'utilisation d'inhibiteurs de l'acétylcholinestérase (AChEI) permet d'augmenter l'activité du système cholinergique en limitant la dégradation physiologique de l'ACh par l'acétylcholinestérase (AChE), à l'extrémité des neurones encore fonctionnels (Ellis, 2005). Ce traitement symptomatique permet de ralentir l'évolution de la maladie qui touche de plus en plus de personnes âgées. En France, plus de 110 000 personnes en sont atteintes chaque année et les 2/3 ont plus de 80 ans (Barré *et al.*, 2007).

Seuls trois AChEI, le donézépil (Aricept®), la risvastigmine (Exelon®) et la galantamine (Rémynil®) sont actuellement autorisés pour le traitement de l'AD mais les problèmes liés à une biocinétique trop rapide, à l'émergence d'effets secondaires, ou à la disparition progressive des effets cliniques justifient encore la recherche de l'AChEI idéal (Pagès *et al.*, 2009a, 2009b). Or la nature produit de nombreux inhibiteurs de cholinestérase (ChEI) dans les règnes végétal (Pagès *et al.*, 2009b, 2009c), fongique, bactérien et animal. Ces molécules, souvent présentes en très faible quantité, ont des structures chimiques très hétérogènes qui servent ensuite de base aux chimistes pour la synthèse de molécules plus efficaces et/ou moins toxiques. Le but de

cette revue est de compléter les articles antérieurs en nous focalisant sur les ChEI issus d'organismes autres que les plantes supérieures. Comme dans l'un de ces articles antérieurs (Pagès *et al.*, 2009c), nous verrons que le plus souvent les propriétés de ChEI sont détectées *in vitro*, mais rares sont celles qui donnent lieu à des recherches *in vivo*. Une hypothèse séduisante (Liston *et al.*, 2004), que nous avons déjà rapportée précédemment (Pagès *et al.*, 2009b) attribue aux AChEI spécifiques un intérêt thérapeutique très largement supérieur à celui des ChEI agissant à la fois sur l'AChE et la butyrylcholinestérase (BuChE) ou majoritairement sur la BuChE. L'affinité pour la BuChE serait responsable d'effets indésirables sévères même si d'autres facteurs ne peuvent être écartés (Otoguro *et al.*, 1997).

Les AChEI sont de deux types: (i) irréversibles ou pseudo-irréversibles qui agissent respectivement en phosphorylant, ou en carbamylant la sérine du site actif. Ils sont utilisés surtout comme armes ou comme insecticides, (ii) réversibles qui inactivent l'AChE en bloquant l'accès du substrat au site actif de l'enzyme ou en induisant des changements conformationnels de l'enzyme. Ils sont surtout utilisés dans un but thérapeutique (Pagès *et al.*, 2009b).

Les ChEI que nous allons répertorier sont des métabolites secondaires (polyketides), c'est-à-dire des substances formées par des bactéries, champignons, organismes marins et Vertébrés et qui, en première intention, ne sont pas en général utiles à l'organisme qui les produit. Ils servent essentiellement à le défendre contre ses prédateurs. Dans cette revue, nous avons regroupé, chaque fois que cela a été possible, les AChEI et BuChEI dans des tableaux en indiquant leur origine, leur nom et leur nature chimique ainsi que leur concentration inhibitrice à 50% (IC<sub>50</sub>) *in vitro* mesurée sur différentes ChE (AChE de *Pseudomonas aeruginosa*, d'insectes, d'anguilles, de foie de rat ou de globules rouges humains et BuChE de *Pseudomonas aeruginosa* ou de sérum de cheval notamment). Nous avons retenu ceux dont les valeurs d'IC<sub>50</sub> sont proches de celles des AChEI de référence tels que galantamine (0,6 µM), tacrine (0,2 µM), donépézil (0,01 µM) ou huperzine (0,08 µM).

Par ailleurs, nous rappellerons, même si nous ne le développons pas dans cette revue, que les AChEI sont à l'origine de nouveaux axes de recherche. Par exemple, le **ladostigil** (TV3326) actuellement en phase II d'étude clinique (dans l'AD, le Parkinson et la dépression) résulte d'une combinaison entre la rivastigmine (AChEI) et la rasigiline (inhibiteur de la monoamine oxydase B) (Martinez, 2008). Les **huprines** résultent de la combinaison en une seule molécule de fragments dérivés de deux AChEI: la tacrine et l'huperzine. Ces huprines associent des effets cholinergiques et non cholinergiques qui en font des molécules pleines de promesses pour traiter l'AD et d'autres désordres neurodégénératifs (Carlier *et al.*, 1999). Une attention particulière est accordée aux AChEI qui se lient simultanément sur le site catalytique et le site périphérique de l'enzyme (Du et Carlier, 2004). Cette capacité serait à l'origine de propriétés biologiques nouvelles qui pourraient intervenir à différents niveaux de la cascade neurotoxique de l'AD (Munoz-Ruiz *et al.*, 2005). Enfin l'intérêt s'est porté sur différentes substances comme les inhibiteurs de la BuChE, les agonistes muscariniques M1 et les agonistes nicotiques alpha-7 [tels l'**anabaséine** de vers aquatiques (némerthes) et son dérivé de synthèse le DMXBA ou GTS21, en phase II d'étude clinique (Kem *et al.*, 2006; Mayer *et al.*, 2010)] qui pourraient aussi avoir un intérêt dans le traitement de l'AD (Martinez, 2008).

## AChEI d'origine bactérienne

Les bactéries peuvent être produites en masse dans des milieux de culture variés et représentent ainsi une ressource inépuisable en principes actifs.

**Tableau 1.** Principaux AChEI d'origine bactérienne.

**Table 1.** Main AChEI of bacterial origin.

Nom	AChEI	Nature	IC <sub>50</sub>	Auteurs
<i>Streptomyces antibioticus</i>	CGA 134735 CGA 134 736	Organophosphate	0,57 µM 0,09 µM	Neumann et Peter, 1987
<i>Streptomyces lavendulae</i>	Cyclophostine	Organophosphate	0,7 - 1,3 nM	Kurokawa <i>et al.</i> , 1993
Actinomycète du sol WK-4164	Cyclophostine	Organophosphate	1,3 nM (BuChE 45 nM)	Otoguro <i>et al.</i> , 1997
Actinomycètes (nature non précisée)	N-98-1272 A, B, C = manumycine C, B, A (antibiotiques)		15 µM, 11,5 µM et 12,5 µM. AChEI réversible non compétitif.	Zheng <i>et al.</i> , 2007
<i>Rapidithrix thailandica</i> TISTR 1742	Marinoquinoline A	Pyrrroloquinoline	4,9 µM	Sangnoi <i>et al.</i> , 2008

Lors d'essais visant à identifier de nouveaux insecticides, trois composés très actifs, contenant un atome de phosphore, ont été isolés à partir de *Streptomyces*. Deux l'ont été à partir de *S. antibioticus*: CGA 134735 et CGA 134 736 (Neumann et Peter, 1987). Le troisième, la **cyclophostine**, isolée à partir de *S. lavendulae*, ainsi que d'Actinomycètes du sol (Otoguro *et al.*, 1997)], est l'un des plus puissants AChEI avec des valeurs d'IC<sub>50</sub> de 0,7 nM sur l'AChE de mouche domestique et 1,3 nM sur l'AChE de la cicadelle brune (*Niliparvata lugens*) contre respectivement 50 nM et 91 nM pour la physostigmine (Kurokawa *et al.*, 1993). Le rapport des activités inhibitrices BuEI/AChEI n'est que de 35, ce qui signifie que sa spécificité pour l'AChE n'est pas très élevée. Il serait cependant intéressant d'établir son IC<sub>50</sub> contre des AChEI de Vertébrés et d'étudier ses propriétés biologiques.

Les **Actinomycètes** sont un groupe d'eubactéries Gram-positives, très abondantes dans le sol où elles jouent un rôle important dans la décomposition des matières organiques. Elles produisent des AChEI, les N98-1272 A, B, et C par la suite identifiées comme étant les Manumycines C, B et A) qui ont une sélectivité marquée pour l'AChE, plus que pour la BuChE. La manumycine A agit comme AChEI non compétitif ( $K_i = 7,2 \mu\text{M}$ ) (Zheng *et al.*, 2007).

*Rapidithrix thailandica* est une bactérie de l'environnement marin (famille des Flammeovirgaceae) (Srisukchayakul *et al.*, 2007). Elle produit la **marinoquinoline** qui possède une activité AChEI. Cette pyrroloquinoline a une structure proche de celle de la tacrine (la liaison à l'enzyme s'explique bien par stacking du noyau quinolinium avec les résidus Trp86 et Tyr337 de l'AChE et liaison hydrogène avec le carbonyl de la chaîne principale de His447). Cependant, d'autres composés de structure voisine isolés de *R. thailandica* n'inhibent pas l'AChE, ce qui suggère que la présence du motif quinolinique commun à la mariquinoline et à la tacrine est nécessaire à l'activité AChEI (Sangnoi *et al.*, 2008).

D'autres AChEI produits par des bactéries ont été signalés dans la littérature: c'est le cas de C-8030 B, C, et D isolés de *Streptomyces pseudogriseolus* (Iwasa *et al.*, 1981) ou de la N8 norphysostigmine isolée de *Streptomyces* sp. (Murao et Hayashi, 1986).

### CHEI isolés de cyanobactéries

Les cyanobactéries sont aussi étudiées comme sources potentielles de nouveaux métabolites dotés d'une activité AChEI. Les structures de ces métabolites, extrêmement variées et souvent inconnues, peuvent ouvrir de nouvelles perspectives à la fois pour les chimistes et les pharmacologues.

**Tableau 2.** Principaux CheI isolés de Cyanobactéries (*Cyanophyceae*, *Nostocales*).

**Table 2.** Main ChEI from cyanobacteria (*Cyanophyceae*, *Nostocales*).

Nom	AChEI	Nature	IC <sub>50</sub>	Auteurs
<b>Anabaena flos-aquae (souche NRC-525-17)</b>	Anatoxine-a(s)	Guanidine méthyl phosphate ester	AChEI: 50 $\mu\text{M}$ <i>in vivo</i> (à titre indicatif) Inhibiteur irréversible	Mahmood et Carmichael, 1987 Hide et Carmichael, 1991
<b>Anabaena spiroides (extrait)</b>			45 mg d' <i>A. spiroides</i> lyophilisées/L	Montserrat <i>et al.</i> , 2001
<b>Nostoc sp (N. sp. str. Lukesova 27/97)</b>	Nostotrebine 6	Polyphénol	AChEI: 5,5 $\mu\text{M}$ BuChEI: 6,1-7,5 $\mu\text{M}$	Zelik <i>et al.</i> , 2010
<b>Nostoc sp (Nostoc 78-12A)</b>	Nostocarboline	Alcaloïde	AChEI: 5,5 $\mu\text{M}$ BuChEI: 13,2 $\mu\text{M}$	Becher <i>et al.</i> , 2009 Becher <i>et al.</i> , 2005
<b>Nostoc ellipsosporum et Nostoc sp.</b>			AChEI > 90% (activités plus faibles mesurées dans d'autres souches de <i>Nostoc</i> )	Zelik <i>et al.</i> , 2009

Parmi les Cyanobactéries filamenteuses aquatiques d'eau douce, certaines sont neurotoxiques, en culture ou lorsqu'elles forment des efflorescences, et provoquent la mort de poissons, oiseaux, chiens (DL<sub>50</sub>: 50  $\mu\text{g}/\text{kg}$ ) et même humains (Mahmood *et al.*, 1988; Cook *et al.*, 1989; Henriksen *et al.*, 1997; Onodera *et al.*, 1997; Dittmann et Wiegand, 2006). Elles contiennent des toxines organophosphorées, **les anatoxines-a(s) et -b(s) [ANTX-a(s) et ANTX-b(s)]** très toxiques pour les Vertébrés [(DL<sub>50</sub>: 20 - 40  $\mu\text{g}/\text{kg}$  (Hyde et Carmichael, 1991)]. *In vitro*, l'ANTX-a(s), isolée d'*Anabaena flos-aquae* (souche NRC-525-17) inhibe irréversiblement l'AChE et la BuChE (Mahmood et Carmichael, 1986). *In vivo*, chez le Rat, elle provoque une hypersalivation qui justifie le « s » d'anatoxine-a(s) (Codd, 2000). Cette action est attribuée à sa capacité d'inhiber, de manière dose-dépendante, l'AChE périphérique; l'inactivation complète de l'enzyme est obtenue pour des doses de 350 à 600  $\mu\text{g}/\text{kg}$  (Mahmood et Carmichael, 1986, 1987; Cook *et al.*, 1989). Elle n'inhibe pas l'activité de l'AChE cérébrale, ce qui suggère qu'elle ne franchit pas la barrière hémato-encéphalique (Cook *et al.*, 1988, 1989), probablement en raison de sa charge, voire double charge positive. Son action est irréversible: seul un prétraitement par la physostigmine ou de fortes concentrations de pyridine-2-aldoxime (2-PAM) peut bloquer l'effet létal de l'ANTX-a(s) (Cook *et al.*, 1991; Hyde et Carmichael, 1991). Le conjugué formé est une méthylphosphoryl sérine qui est analogue aux formes vieilles obtenues avec les neurotoxiques de guerre. Il n'est donc à priori pas possible de le réactiver. Il n'est pas impossible que la réactivation observée par Hyde *et al.* en présence de forte concentration de 2-PAM soit de nature artéfactuelle, par exemple en raison d'une hydrolyse directe de l'acétylthiocholine par le 2-PAM. L'ANTX-a(s) pose un grave problème de santé publique et il est fondamental de pouvoir la détecter et la doser dans les eaux (Devic *et al.*, 2002). Son utilisation thérapeutique n'est pas actuellement envisageable ...

Des extraits aqueux d'une autre espèce d'*Anabaena*, *A. spiroides*, ont une activité d'AChEI sur des enzymes de poisson (IC<sub>50</sub>: 17,2 mg de cyanobactéries lyophilisées/L), de crabe (IC<sub>50</sub>: 45 mg/L), ou d'anguille (IC<sub>50</sub>: 23 mg/L). L'addition de 2-PAM *in vitro* ne permet pas de réverser l'inhibition enzymatique, ce qui suggère que l'inhibition du centre actif de l'AChEI est irréversible (Montserrat *et al.*, 2001).

Les Cyanobactéries du genre *Nostoc* ressemblent à des algues: elles forment des masses d'aspect gélatineux présentes dans différents milieux. Elles ont la capacité de se déshydrater et de se réhydrater très rapidement. Leur forme varie selon le milieu. Une équipe tchèque a purifié la **nostotrébine 6** à partir d'une souche de *Nostoc* sp. str. Lukešova 27/97: action inhibitrice non compétitive puissante pour l'AChE (IC<sub>50</sub>: 5,5 µM); elle inhibe aussi la BuChE (IC<sub>50</sub>: 6,1-7,5 µM) (Zelik *et al.*, 2010); la composante non compétitive de l'inhibition est due au fait que l'inhibiteur se lie à la fois à l'enzyme libre et à l'acyl-enzyme. En fait, d'autres souches de *Nostoc* ont une activité AChEI, comme *N. elliposporum* Rabenh. str. Lukesova 51/91, ou *N. elliposporum* str. Lukesova 52/91 (Zelik *et al.*, 2009). La **nostocarboline** a été purifiée et caractérisée par une équipe suisse à partir de la souche *Nostoc* sp. (78-12A) provenant du Michigan; elle présente, comme la nostotrébine, des activités inhibitrices non compétitives puissantes de l'AChE (IC<sub>50</sub> de 5,3 µM) et la BuChE (Becher *et al.*, 2005; 2009). Elle n'est pas très toxique et pourrait agir localement au niveau de la bouche des prédateurs pour permettre à *Nostoc* de se protéger (Becher *et al.*, 2009).

### AChEI d'origine fongique

Les champignons, en particulier d'origine marine, sont connus depuis longtemps comme source potentielle de puissants AChEI (Faulkner, 2000; Bugni et Ireland, 2003; Saleem *et al.*, 2007). Des études de séquençage du génome de champignons ont révélé que ces microorganismes ont de nombreuses voies de synthèse de métabolites secondaires. La plupart de ces métabolites et leurs voies de biosynthèse sont souvent méconnues, soit parce qu'ils sont produits en très faible quantité et donc difficiles à détecter, soit parce qu'ils sont produits seulement dans des conditions particulières (Chiang *et al.*, 2009).

**Tableau 3.** Principaux AChEI d'origine fongique.

**Table 3.** Main AChEI of fungal origin.

Nom	AChEI	Nature	IC <sub>50</sub> AChE	IC <sub>50</sub> BuChE	Auteurs	
<b>Ascomycètes</b>						
<i>Aspergillus flavus</i>	Aflatoxine B1		31,6 µM		Cometa <i>et al.</i> , 2005	
<i>Aspergillus terreus</i>	Isoterreulactone A	Méro- terpénoïdes	2,5 µM	> 500 µM	Yoo <i>et al.</i> , 2005	
	Terreulactones A, B, C et D		0,06-0,42 µM	> 200 µM	Kim <i>et al.</i> , 2002; 2003; Cho <i>et al.</i> , 2003	
<i>Aspergillus terreus</i> et <i>Penicillium</i> sp.	Arisugacine A		1,0 nM	> 21 µM	Omura <i>et al.</i> , 1995; Kuno <i>et al.</i> , 1996a, b; Otoguro <i>et al.</i> , 1997; Kim <i>et al.</i> , 2003	
	Arisugacine B		25,8 nM	> 516 µM		
Mutant de <i>Penicillium</i> sp.	Arisugacines C et D			2,5 et 3,5 µM	ND	Otoguro <i>et al.</i> , 2000
<i>Aspergillus terreus</i> et <i>Penicillium</i> sp.	Territrème A			0,1 µM	ND	Dowd <i>et al.</i> , 1992
	Territrème B			7,6 nM	> 20 µM	Chen et Ling, 1996; Otoguro <i>et al.</i> , 1997; Chen <i>et al.</i> , 1999
	Territrème C			6,8 nM	> 26 µM	Ling, 1994; Shiomi <i>et al.</i> , 1999;
<i>Nectria galligena</i>	Collétochlorine B Ilicicolines C et E			30-36 µg/mL	ND	Gutierrez <i>et al.</i> , 2005
<i>Penicillium citrinum</i>	Quinolactacine A1		Pyrrolo- quinolone	280 µM	ND	Kim <i>et al.</i> , 2001
	Quinolactacine A2	19,8 µM		350 µM		
<i>Penicillium cyclopium</i> <i>Penicillium</i> sp.	Cyclopinine	Alcaloïde	2,04 µM	4080 µM	Mohammed et Luckner, 1963 Otoguro <i>et al.</i> , 1997	
<i>Fusarium tricinctum</i>	Visoltricine Dérivé N méthylé		0,4 mM 0,007 mM		Visconti et Solfrizzo, 1994; Solfrizzo et Visconti, 1994; Orhan et Sener, 2003	
<i>Paecilomyces</i> sp.	Paeciloxanthone	Xanthone	2,25 µg/mL	ND	Lu <i>et al.</i> , 2008	
<i>Xylaria</i> sp.	Xylokétal A		1,5 µM		Lin <i>et al.</i> , 2001	
<b>Eumycètes- Division Basidiomycètes</b>						
<i>Cortinarius infractus</i>	Infractopicrine et 10-OH-Infractopicrine	Alcaloïdes			Geissler, 2010	
<i>Clavicornia pyxidata</i>	Extrait butanolique Extrait éthanolique Extrait aqueux		99,3% 93,7% 91,7%		Lee <i>et al.</i> , 2006	

La souche d'*A. terreus* utilisée dans les études est la souche Fb000501. Celle de *P. sp.* est la souche FO-4259. Celle de *S. antibioticus* est la souche DSM 1951. Celle de *S. lavendulae* est la souche NK901093. ND = non disponible.

Les *Aspergillus* sont des champignons généralement considérés comme des espèces terrestres mais le genre est tolérant à de fortes concentrations en sel et peut se développer en mer. *A. terreus* est un champignon ubiquitaire de notre environnement et à ce titre, il est très utilisé comme source de métabolites secondaires (Parvatkar *et al.*, 2009). Mais d'autres *Aspergillus* ainsi que les *Penicillium* sont aussi largement exploités.

Par exemple, *A. flavus* a pour métabolite secondaire l'**aflatoxine B1** dont la toxicité est très connue (Pagès *et al.*, 2004). Sa toxicité provient en partie d'un effet cholinergique puissant. Elle inhibe, en effet, de façon non compétitive, l'activité des deux isoformes de l'AChE (G1 et G4) (Pagès 2009b) de cerveau de souris de manière dose dépendante avec une valeur d'IC<sub>50</sub> de 31,6 µM. Elle agirait en bloquant l'accès du substrat au site actif de l'enzyme ou bien en se liant de façon non covalente sur le site périphérique de l'enzyme. L'enzyme n'est que lentement réactivée par la 2-PAM, ce qui confirme le caractère non-covalent de la fixation de l'aflatoxine (Cometa *et al.*, 2005), probablement par le déplacement de l'aflatoxine du site périphérique.

De même, des **méroterpénoïdes isocoumariniques** représentés par l'**isoterreulactone**, les **terreulactones A-D**, les **arisugacines A-D** et les **territrèmes A-C** ont été isolés d'*A. terreus* et/ou de *Penicillium* sp. Une parenté biogénétique a été proposée entre isoterreulactone et arisugacine A (Houghton *et al.*, 2006) et entre terreulactone A et arisugacine B (Kuno *et al.*, 1996b). Tous inhibent puissamment l'activité de l'AChE de manière dose-dépendante *in vitro* et sont beaucoup plus sélectifs pour l'AChE que pour la BuChE (Shiomi *et al.*, 1999).

L'**isoterreulactone** et les **terreulactones** ont donné essentiellement lieu à des travaux de chimie (Kim *et al.*, 2002; 2003; Yoo *et al.*, 2005). Ce sont des AChEI extrêmement puissants et 500 à 3000 fois plus sélectifs pour l'AChE que pour la BuChE (Cho, 2003), la structure de ces ligands suggérant qu'ils occupent toute la gorge de l'enzyme jusqu'au site périphérique de l'AChE.

L'**arisugacine A** isolée d'abord d'*A. terreus* pourrait être utilisée avec succès dans le traitement de l'AD et d'autres démences pour les raisons suivantes (Kuno *et al.*, 1996a; Otaguro *et al.*, 1997; McGlacken et Fairlamb, 2005): *in vitro*, son efficacité est largement supérieure à celle de la tacrine, du donépézil et de l'huperzine (McGlacken et Fairlamb, 2005; Houghton *et al.*, 2006); *in vivo*, elle protège les souris de l'amnésie induite par la scopolamine (McGlacken et Fairlamb, 2005). Elle a été synthétisée et a servi de modèle à la synthèse d'autres molécules analogues, porteuses du motif 2-pyrone (McGlacken et Fairlamb, 2005). Elle a été isolée également à partir de culture de *Penicillium* sp., en même temps que l'**arisugacine B**, et les **territrèmes A et B** qui tous les quatre inhibent spécifiquement l'AChE, 2000 fois plus que ne le fait la tacrine. Or cette dernière, bien qu'ayant fait la preuve de son efficacité dans l'amélioration du fonctionnement cognitif des malades souffrant d'AD, a été retirée du marché en raison de la sévérité de ses effets secondaires (hépatotoxicité; McGlacken et Fairlamb, 2005). Il est fort important de noter que les quatre méroterpénoïdes sont beaucoup plus sélectifs que la tacrine, ce qui ouvre des perspectives thérapeutiques intéressantes pour traiter l'AD. Des recherches ultérieures ont permis d'isoler à partir de cultures de mutant de *Penicillium* sp., une série de métabolites désignés arisugacines C-H, parmi lesquels les dérivés C et D ont une activité AChEI importante (Otaguro *et al.*, 2000).

Les **territrèmes A, B, C, A' et B'** ont été isolés d'*A. terreus* (Ling *et al.*, 1979). Tous ont le même squelette chimique (Lee *et al.*, 1992). A la différence des autres mycotoxines induisant des tremblements chez l'animal, ils ne contiennent pas d'azote. *In vivo*, l'induction de tremblements chez le Rat et la Souris est le signe le plus évident de toxicité aiguë qui n'apparaît que lorsque les terminaisons des nerfs moteurs sont intactes (Ling *et al.*, 1984; Ling, 1994). Ils ne sont donc pas particulièrement toxiques chez le rat, la souris ou les insectes (*Helicoverpa zea*) (Dowd *et al.*, 1992). En revanche, ce sont de puissants AChEI de type tight-binding possédant une constante de dissociation très faible, *in vitro* (Chen *et al.*, 1999). Ils n'ont pas d'activité BuChE. Un insecticide potentiel, extrait d'*A. niger* est actif sur les larves de *Chrysomya chloropyga*, avec une DL<sub>50</sub> de l'ordre de 0,05 mg/g d'aliment. L'activité pourrait être liée à la présence de tertrittèmes (Essien, 2004).

Le groupe suivant de méroterpénoïdes ayant une activité AChEI modérée a été obtenu par culture liquide du champignon phytopathogène des arbres à bois dur, *Nectria galligena* (Hypocreacées) ou Chancre nectrien: parmi eux, la **colétochlorine B**, et les **ilicicolines C et E** sont les plus actives sur l'AChE avec des valeurs d'IC<sub>50</sub> comprises entre 30-36 µg/mL (Gutierrez *et al.*, 2005).

D'autres AChEI produits par des *Aspergillus* et des *Penicillium* ont été rapportés dans la littérature, comme I6123 isolé d'*A. terreus* (Ogata *et al.*, 1974), les **quinolactacines A1** et surtout **A2**, isolée de *P. citrinum* (Kim *et al.*, 2001), la **cyclopénine**, isolée d'abord de *P. cyclopium* puis de *Penicillium* sp. (Otaguro *et al.*, 1997) ou encore la **4-hydroxymelleine** (dihydroisocoumarine), isolée de *Penicillium* sp. 2, endophyte des feuilles d'*Alibertia macrophylla* (Rubiaceae) (Oliveira *et al.*, 2009).

Un autre AChEI puissant isolé de *Fusarium tricinctum* est la **visoltricine** (IC<sub>50</sub>= de 0,26 mM dans le sérum humain, 0,4 mM pour les érythrocytes bovins et 0,19 mM pour les CHE sériques humaines). Son dérivé N-méthylé est plus puissant (IC<sub>50</sub>= 0,007 mM) (Visconti et Solfrizzo, 1994; Solfrizzo et Visconti, 1994).

Le champignon métatrophique (qui se nourrit de matière organique morte) *Paecilomyces* sp. sécrète une xanthone, la **paeciloxanthone** dotée d'une forte activité AChEI (2,25 µg/mL) (Lu *et al.*, 2008).

Le champignon *Xylaria* sp. sécrète 6 xyloketals et parmi eux, le **xylokétal A** qui a une forte activité AChEI (Lin *et al.*, 2001). Une autre équipe a rapporté pour les **xyloketals A-D**, des valeurs d'IC<sub>50</sub> sur l'AChE de 29,9, 137,4, 109,3 et 425,6 µM respectivement. Ils agissent de façon réversible et non compétitive. La BuChE est également inhibée, mais les valeurs d'IC<sub>50</sub> n'ont pas été précisées (Lin *et al.*, 2001; Jinghui *et al.*, 2004).

*Stenocarpella maydis* (anciennement nommé *Diplodia maydis*), agent de la moisissure du maïs, produit un métabolite, la **diploidiatoxine**, isolée par Riet-Corea *et al.* (1993). Cette toxine est également présente chez *Fusarium moniliforme* (Hassanin et Gabal, 1990). Par voie orale, elle inhibe de façon réversible l'AChE cérébrale du rat (Rahman *et al.*, 2002), à dose unique élevée (5,7 mg/kg) ou à faible dose administrée de façon chronique (0,27 mg/kg/jour) et induit des convulsions. L'ingestion de maïs parasité peut conduire à la mort du

bétail (10 génisses ont succombé dans un troupeau contaminé de 500 têtes); les autres animaux intoxiqués ont totalement récupéré après retrait du maïs contaminé de leur alimentation. Chez les plus touchés (paralysie ou perturbation locomotrice), des lésions histologiques du cerveau et du cervelet ont été observées (Odriozola *et al.*, 2005). Cependant, la diplodiatoxine n'est probablement pas la toxine principale de *Diplodia* ou bien sa toxicité peut s'exercer sur d'autres cibles que le système nerveux (Rabie *et al.*, 1977; Kriek et Marasas, 2004). Elle perturbe en effet d'autres enzymes que les ChE, comme la phosphatase acide, la phosphatase alcaline, l'aspartate-aminotransférase (ASAT) ou l'alanine-aminotransférase (ALAT) (Rahman *et al.*, 2002; Rao *et al.*, 2003). Elle exerce aussi un effet antibactérien (Rao et Achar, 2001). En raison de sa toxicité, la diplodiatoxine n'a pas d'avenir sur le plan thérapeutique dans l'AD, dans l'état actuel des connaissances.

Des activités AChEI ont aussi été signalées chez un Deutéromycète imparfait, *Sporotrichum* sp., avec une valeur d'IC<sub>50</sub> de 20 µM sur l'AChE de cerveau de rat (Shivanandappa *et al.*, 2006), chez un Hyphomycète, *Chrysosporium* sp. (Sekhar Rao *et al.*, 2001), ou encore chez divers *Penicillium* tropicaux (Rodrigues *et al.*, 2001).

Enfin, parmi les champignons supérieurs, les cortinaires contiennent deux AChEI, l'**infractopicrine** et la **10-OH-infractopicrine** capables, en outre, d'inhiber *in vitro* l'auto-agrégation du peptide bêta-amyloïde, mais pas l'agrégation induite par l'AChE. Ils sont plus sélectifs pour l'AChE que la galantamine. Leur toxicité est faible (Geissler *et al.*, 2010). Ces principes actifs sont intéressants car ils présentent naturellement les mêmes capacités que des molécules chimères de synthèse associant un AChEI ayant une bonne affinité pour le site actif de l'enzyme et une deuxième molécule (ou fragment de molécule) se fixant sur le site périphérique; ils sont connus sous le nom de « dual binding site AChEI » (Galdeano *et al.*, 2010). Ces travaux ont renouvelé l'intérêt porté aux AChEI car ces nouvelles molécules, en se fixant sur les deux sites de l'AChE, inhibent à la fois l'activité de l'enzyme et, *in vitro*, la formation et/ou l'agrégation du peptide bêta-amyloïde à l'origine de la cascade amyloïdérique responsable de la maladie *in vivo* (Rosini *et al.*, 2008; Camps *et al.*, 2010). L'**infractopicrine** et la **10-OH-infractopicrine** sont donc de bons candidats pour le traitement de l'AD.

Des extraits éthanoliques et aqueux de *Clavicornia pyxidata* DGUM 29005 inhibent de manière dose-dépendante *in vitro*, sur des cellules PC12 en culture (de phéochromocytome de rat) non seulement l'AChE (IC<sub>50</sub> de 67,5 µg/mL) mais aussi la bêta-sécrétase responsable avec la gamma-sécrétase de la formation des peptides bêta-amyloïdes dans le cerveau des malades AD (Pagès *et al.*, 2009 p 102). De plus, les extraits ne sont pas cytotoxiques (Lee *et al.*, 2006). Ces résultats très prometteurs devront être reproduits *in vivo*. Là encore, ces produits naturels sont dotés naturellement d'une activité recherchée par les pharmacologues: celle d'inhiber la bêta-sécrétase, première étape conduisant à la formation du peptide bêta-amyloïde (Tanzi, 2008).

## AChEI isolés d'algues

Les algues représentent aussi une source inépuisable de composés dotés de propriétés physiologiques. La plupart de celles qui ont été étudiées inhibent les deux ChE.

Tableau 4. Principaux ChEI produits par des algues.

Table 4. Main ChEI of algal origin.

Nom	AChEI	Nature	IC <sub>50</sub> AChE	IC <sub>50</sub> BuChE	Auteurs
<b>Phaeophyceae-Fucales</b>					
<i>Sargassum sagamianum</i>	Dérivé 1 Dérivé 2	Farnesyl-acétone	65 µM 48 µM	34 µM 23 µM	Ryu <i>et al.</i> , 2003
<i>Sargassum sagamianum</i>	Acide argaquinolique Sargachromenone	Plastoquinones	23,2 µM 32,7 µM	26 nM	Choi <i>et al.</i> , 2007
<i>Sargassum</i> sp.	Extrait (2 mg/mL)		> 50% d'inhibition	> 50% d'inhibition	Natarajan <i>et al.</i> , 2009
<b>Phaeophyceae-Dictyotales</b>					
<i>Padina gymnospora</i>	Extrait		2,6 µM		Suganthy <i>et al.</i> , 2010
<i>Dictyota dichotoma</i>	Extrait			6,5 µM	Suganthy <i>et al.</i> , 2010
<b>Florideophyceae-Gracilariales</b>					
<i>Gracilaria gracilis</i> <i>Gracilaria edulis</i>	Extraits (2-3 mg/mL)		> 50% d'inhibition	> 50% d'inhibition	Natarajan <i>et al.</i> , 2009; Suganthy <i>et al.</i> , 2010
<b>Rhodophyceae-Gelidiales</b>					
<i>Hypnea valentiae</i>	Extrait		2,6 µM	3,9 µM	Suganthy <i>et al.</i> , 2010
<b>Chlorophyceae-Cladophorales</b>					
<i>Cladophora fascicularis</i>	Extrait (2 mg/mL)		> 50% d'inhibition		Natarajan <i>et al.</i> , 2009
<b>Chlorophyceae-Ulotrichales</b>					
<i>Enteromorpha intestinalis</i>	Extrait			7,6 µM	Suganthy <i>et al.</i> , 2010
<b>Ulvoephyceae-Ulvales</b>					
<i>Ulva reticulata</i>	Extrait		10 µM	10 µM	Suganthy <i>et al.</i> , 2010

Des laminaires, les sargasses, ont révélé des propriétés d'AChEI: deux dérivés farnesyl acétone ont d'abord été isolés de *Sargassum sagamianum*; leur activité ChEI est modérée (Ryu *et al.*, 2003); plus récemment, Choi *et al.* (2007) ont démontré une activité un peu plus puissante de deux plastoquinones, l'**acide argaquinolique** (IC<sub>50</sub> pour AChEI: 23,2 µM; BuChEI: 26 nM) et le **sargachroménol** (IC<sub>50</sub> pour AChEI 32,7 µM). Des extraits de *Sargassum siliquastrum* sont BuChEI (Jang *et al.*, 2005). Des extraits (2 mg/mL) de *Sargassum* sp. ont inhibé plus de 50% de l'activité AChE et BuChE; ceux de l'algue rouge *Gracilaria gracilis* et de l'algue verte, *Cladophora fascicularis* ont inhibé 50% de l'activité de l'AChE; ceux de *G. edulis* ont inhibé 50% de l'activité BuChE (Natarajan *et al.*, 2009). En 2010, des activités AChEI ont été mises en évidence dans des extraits de diverses algues (rouges: *Hypnea valentiae*, *G. edulis*; vertes: *Ulva reticulata* et *Enteromorpha intestinalis*; brunes: *Padina gymnospora*, *Dictyota dichotoma*) (Suganthi *et al.*, 2010). Une autre Laminiaire, *Ecklonia clava* produit du **dieckol** et du **phlorofucofuroeckol** qui, par voie orale, améliorent, *in vivo*, la mémoire chez la souris. En parallèle, les concentrations d'ACh ont augmenté dans différentes aires cérébrales (striatum, hippocampe et cortex frontal), ce qui a été attribué en partie à une activité d'AChEI (Myung *et al.*, 2005).

### AChEI isolés d'invertébrés marins

Les AChEI d'origine marine sont encore mal connus, mais les recherches se sont multipliées, depuis quelques années, pour trouver de nouvelles molécules efficaces dans le traitement de l'AD. Elles concernent notamment des éponges et des coraux qui ont peu de prédateurs. Ils sont donc probablement dotés d'une force de dissuasion chimique qui les protège également contre les bactéries et les virus. Ils constituent une source de médicaments potentiels extrêmement importante.

**Chez les Dinoflagellés**, *Gymnodium breve* (*Ptychodiscus brevis*) renferme une toxine (**O,O-dipropyl(E)-2-(1-méthyl-2-opropylidène)phosphorohydrazidothioate (E) oxime** (organo-thio-phosphate) qui a été isolée, synthétisée et dont des analogues ont été préparés (Kumar *et al.*, 2007); son activité AChEI s'exerce *in vivo* et *in vitro*: sa DL<sub>50</sub> est de 55 mg/kg chez la souris par voie intrapéritonéale, certains analogues étant plus efficaces (IC<sub>50</sub> variant de 2,8 à 4 mM); l'activité inhibitrice est plus importante dans le sérum (61% d'inhibition) que dans le cerveau (36,6%) (Husain *et al.*, 1996). Son activité est toutefois beaucoup trop faible pour être utilisée en thérapeutique.

**Chez les Porifères** (éponges), plusieurs espèces présentent des métabolites AChEI.

- Les **poly-APS** (3-alkylpyridinium polymer) isolés de *Reniera sarai* agissent spécifiquement mais progressivement sur l'AChE: *in vitro*, la liaison est d'abord réversible et de type non compétitif, par liaison avec le site anionique périphérique de l'enzyme (K<sub>i</sub> de 11 nM), puis devient progressivement irréversible par formation d'un agrégat enzyme-APS. L'activité des poly-APS dépendant de la taille du polymère, suggère qu'ils se lient probablement à plusieurs sites de l'enzyme (Sepcic *et al.*, 1998). Ils possèdent des activités hémolytique et cytotoxique *in vitro*. Leur activité d'agent antifouling est liée à leur capacité à inhiber les bactéries marines. Chez le rat, ils sont létaux à la dose de 2,7 mg/kg (voie intraveineuse), mais la mort est due à l'hémolyse et pas à l'effet AChEI qui n'est observable qu'à faible dose (Turk *et al.*, 2007). Un effet inattendu de ces polymères est de cibler les tumeurs pulmonaires non à petites cellules sur lesquelles ils exercent une cytotoxicité sélective respectant les cellules normales aussi bien *in vitro* qu'*in vivo* (Paleari *et al.*, 2006). Ces tumeurs expriment, en effet, des molécules intervenant dans le fonctionnement cholinergique: en inhibant l'AChE, le poly-APS bloque leur activité cholinergique et provoque la mort des cellules par apoptose (Turk *et al.*, 2007).

- L'**aplysamine-4** est un métabolite dérivé de la bromotyrosine provenant d'une éponge du genre *Verongia* de Mer Rouge; elle exerce une faible activité AChEI, non compétitive et réversible, avec un K<sub>i</sub> de 16 µM pour l'AChE de torpille (Sepcic *et al.*, 2001).

- La **pétrosamine**, un alcaloïde isolé de l'éponge thaïlandaise *Petrosia* n. sp., a une activité AChEI 6 fois supérieure à celle de la galantamine prise comme référence. Elle pourrait remplacer la galantamine lorsque l'effet thérapeutique de cette dernière s'épuise (Nukoolkarn *et al.*, 2008).

- La **4-acetoxy-plakinamine B**, un alcaloïde stéroïdien isolé de l'éponge *Corticium* sp., a une activité AChEI (IC<sub>50</sub> = 3,75 µM sur l'AChE de gymnote), supérieure à celle d'autres alcaloïdes stéroïdiens isolés d'une plante du genre *Saracocca* (Buxaceae) mais inférieure à celle de la galantamine prise pour référence (0,59 µM). Son mécanisme d'inhibition est de type mixte, à la fois compétitif et non compétitif (Langjae *et al.*, 2007).

- L'**aerothionine**, l'**homoaerothionine**, la **11-19-dideoxyfistularine** isolées d'*Aplysina cavernicola* ont une activité AChEI (Martinez *et al.*, 2005).

- L'inhibition de l'AChE a été recherchée dans des extraits de différentes éponges (*Agelas clathrodes*, *Agelas conifera*, *Topsentia ophiraphidites*, *Xestospongia pacifica*) en milieu aqueux ou organique: les extraits ont révélé une faible activité; la plus importante (62% d'inhibition) a été mesurée dans un extrait méthanolique de *Topsentia ophiraphidites* (217 µM) (Sepcic *et al.*, 2010).

**Chez les Cnidaires**, certains Anthozoaires ont une activité AChEI:

- Le Zoanthaire *Parazoanthus axinellae* fabrique des pigments (**pseudo zoanthoxantine** et **zoanthoxantine**) à faible activité AChEI quelle que soit l'origine de l'enzyme (Turk *et al.*, 1995; Strupi Suput *et al.*, 1996). De plus, ces pigments sont toxiques (DL<sub>99</sub> de 4 mg en 5 min chez la souris (Turk *et al.*, 1995).

- Des représentants de la famille des Alcyonaires (Octocoralliaires, « Soft Corals ») ont une activité AChEI faible: il s'agit de *Cladiella* dont le **cladidiol** présente une activité modeste (Ata *et al.*, 2004) et de *Lobophytum*



sp., chez laquelle l'activité AChEI du **Crassumolide E** (cembranoïde) a été détectée *in vitro* à partir de 1 µg (alors que l'activité de la galantamine est détectée à 0,01 µg) (Bonnard *et al.*, 2010). D'autres **cembranoïdes** exercent un effet neuroprotecteur, en particulier en agissant sur les récepteurs nicotiques (Ferchmin *et al.*, 2009).

Chez les **Sipunculien**, la **phascolosomine** (Guanidine N-(3-guanidinoisobutyl)-2-methoxy-n-heptylamine; CAS N° 50767-86-7) est un dérivé de la guanidine présent dans les viscères de *Phascolosoma*; elle a un effet AChEI modéré ( $K_i$  de 3,6 à 7,5. 10<sup>-4</sup>M) (Matsumoto *et al.*, 1977).

Chez les **Mollusques Gastéropodes Pulmonés marins**,

- L'**Onchidal** isolé de *Onchidella binneyi* est un AChEI irréversible: la fixation à l'AChE est d'abord lente et réversible (affinité de 300 µM), puis elle devient irréversible, ce qui pourrait être dû à la formation d'une nouvelle liaison covalente entre la toxine et l'enzyme; son activité molaire est élevée (325 min<sup>-1</sup>); il protège les Mollusques contre la prédation exercée par les poissons (Abramson *et al.*, 1989).

- Plus récemment, les **turbotoxines A et B** ont été purifiées à partir des viscères de *Turbo marmorata*; ce sont des dérivés de la diiodotyramine, toxiques pour la souris [(DL<sub>50</sub> de 1 et 4 mg/kg, respectivement (Kigoshi *et al.*, 1999)]; la **turbotoxine A** a une IC<sub>50</sub> sur l'AChE de 28 µM (Kigoshi *et al.*, 2000).

Tableau 5. Principaux AChEI provenant d'invertébrés marins.

Table 5. Main AChEI from marine invertebrates.

Nom	AChEI	Nature	IC <sub>50</sub>	Auteurs
<b>Dinoflagellés</b>				
<i>Gymnodium breve</i>	O,O-dipropyl(E)-2-(1-méthyl-2-opropylidène) phosphorohydrazidothioate (E) oxime	Organo-thio-phosphate	Faible	Husain <i>et al.</i> , 1996
<b>Porifères (Eponges)</b>				
<i>Reniera sarai</i>	PolyAPS	Polymère de 3-alkylpyridinium		Turk <i>et al.</i> , 2007
<i>Verongia</i>	Aplysamine-4	Métabolite de la bromotyrosine	16 µM	Sepecic <i>et al.</i> , 2001
<i>Petrosia</i> n. sp.	Petrosamine	Pyridoaclidine alcaloïde	0,091 µM, (6 fois plus active que galantamine)	Nukoolkarn <i>et al.</i> , 2008
<i>Corticium</i> sp.	4-acétoxy-plakinamine B	Alcaloïde stéroïdien	3,75 ± 1,7 µM	Langjae <i>et al.</i> , 2007
<b>Cnidaires</b>				
<i>Parazoanthus axinellae</i> (Zoanthaire)	Dérivé de la pseudozoanthoxanthine présent dans les genres <i>Parazoanthus</i> , <i>Epizoanthus</i> , <i>Zoanthus</i> , <i>Palythoa</i>	Tétrazacyclopentazulène	Inhibition compétitive, $K_i = 4$ µM $K_i = 50$ µM ACh de GRH $K_i = 0,18$ µM AChE ganglion cervical bovin	Turk <i>et al.</i> , 1995; Sepecic <i>et al.</i> , 1998 Suput <i>et al.</i> , 1996
<i>Lobophytum</i> sp. (Alcyonnaire)	Crassumolide E	Cembranoïde (diterpénoïde)	100 fois moins actif que la galantamine	Dunlop <i>et al.</i> , 1979
<b>Sipunculien</b>				
<i>Phascolosoma vulgare</i> , et <i>P. elongata</i>	Phascolosomine	Guanidine	$K_i$ : 360-750 µM	Matsumoto <i>et al.</i> , 1977
<b>Mollusques Gastéropodes</b>				
<i>Onchidella binneyi</i>	Onchidal			Abramson <i>et al.</i> , 1989
<i>Turbo marmorata</i>	Turbotoxines A et B	Dérivés de la diiodotyramine	<b>A</b> : 28 µM	Kigoshi <i>et al.</i> , 1999, 2000

GRH = globules rouges humains

## AChEI isolés de Vertébrés

Il est difficile de clore une revue portant sur les AChEI naturels sans parler des **fasciculines**, toxines appartenant à la super-famille des toxines à trois doigts (un polypeptide de 61 résidus d'acides aminés formant trois boucles et réticulé par quatre ponts disulfure) isolées du venin d'Elapidés arboricoles, les mambas très répandus en Afrique australe (mambas noirs: *Dendroaspis angusticeps*, *D. viridis*, *D. jamesoni*, mamba vert: *D. polylepis*): ces toxines sont des inhibiteurs puissants et spécifiques des AChE, qu'elles inhibent de façon non compétitive (fixation sur le site périphérique) (Marchot, 1999). Elles empêchent la destruction de l'ACh dans la

fente synaptique, ce qui conduit à une dépolarisation permanente de la membrane post-synaptique et à des fasciculations musculaires sévères, généralisées et durables (5 à 7 heures) suivies d'une récupération clinique incomplète. La paralysie respiratoire peut être retardée par l'administration de doses élevées d'atropine (50 mg/kg). L'utilisation d'oxime est sans effet (Pita *et al.*, 2003).

La toxicité est dose-dépendante, proportionnelle à la quantité de récepteurs atteints, c'est-à-dire à la quantité inoculée. Elle dépend peu de la durée d'action car les symptômes s'installent très rapidement. Les  $DL_{50}$  varient selon les espèces mais sont toujours très faibles, comprises, par exemple, entre 0,25 et 3,05  $\mu\text{g}/\text{kg}$  par voie intraveineuse chez la Souris (Larréché *et al.*, 2008).

La **fasciculine 1** (FAS 1) et la **fasciculine 2** (FAS 2) isolées du venin de *D. angusticeps* diffèrent par le remplacement d'un résidu Tyr par Asn en position 47 (Rodríguez-Ithurralde *et al.*, 1983; Karlsson *et al.* 1984). La fasciculine 3 (FAS 3) isolée d'un venin de *Dendroaspis viridis* (Marchot *et al.*, 1993) est identique à la Toxine C précédemment isolée du venin de *D. polylepsis* (Joubert et Taljaard, 1978). *In vitro*, FAS 1 et 2 présentent une très forte affinité ( $K_i = 10^{-10}\text{M}$ ) et une grande sélectivité pour l'AChE (Cervenansky *et al.*, 1995) qu'elles inhibent par blocage stérique et allostérique en se liant au niveau du site périphérique (Marchot, 1999). La liaison de FAS 3 avec l'AChE de cerveau de rat provoque l'inhibition instantanée de l'enzyme (Marchot *et al.*, 1993). Le complexe se dissocie lentement ( $t_{1/2}$ : 48 h), avec une constante de dissociation,  $K_d$ , de 0,4 pM.

L'interaction entre les fasciculines et l'AChE a fait l'objet de nombreuses études (Marchot *et al.*, 1993; Bourme *et al.*, 1995; Harel *et al.*, 1995; van den Born *et al.*, 1995; revue de Marchot, 1999; Kryger *et al.*, 2000). Des dérivés préparés par synthèse peptidique, génie génétique ou chimie des protéines ont permis une approche fine des sites d'action (Falkenstein et Pena, 1997; Marchot *et al.*, 1997; Bernard et Krejci, 2008 pour revue; Sharabi *et al.*, 2009).

*In vitro*, sur des modèles de jonction neuro-musculaire, et en conditions physiologiques, FAS 1 (10-100 nM) augmente l'amplitude et allonge progressivement de 20 à 30%, les temps de montée et de décroissance des courants miniatures de la plaque motrice, indiquant une inhibition profonde de l'AChE. En revanche, FAS 1, lors d'une stimulation nerveuse, augmente les courants synaptiques évoqués de près de 100%. Cet effet intervient immédiatement après l'application de FAS 1 et ne peut s'expliquer par la seule prolongation de la durée de vie de l'ACh due à l'inhibition de l'AChE. FAS 1 pourrait donc augmenter la libération d'ACh par les terminaisons synaptiques. Les effets de FAS 1 sont lentement réversibles (Hermel et Stinnakre, 1993). Déjà utilisée dans le traitement du glaucome, FAS 1 pourrait avoir un intérêt dans le traitement de certaines myasthénies (Hermel et Stinnakre, 1993).

*In vivo*, l'injection de FAS 2 dans le muscle gastrocnémien provoque au bout de 21h une inhibition presque complète de l'AChE dans la région de la moelle épinière correspondant au muscle injecté. Cette propriété pourrait être exploitée pour diriger la fasciculine vers des neurones centraux (Rodríguez-Ithurralde et Vincent, 1994). Enfin, l'injection de la fasciculine dans différentes aires cérébrales (striatum, locus coeruleus, substantia nigra) a presque complètement inhibé (80-90%) l'activité de l'AChE autour du point d'injection, le retour à une activité normale se faisant très lentement (Dajas *et al.*, 1987, 1993; Abo *et al.*, 1989; Bolioli *et al.*, 1989). Des atteintes comportementales ont été observées en parallèle et attribuées à l'altération de la transmission cholinergique (Abo *et al.*, 1989; Dajas *et al.*, 1993). Dans ces conditions, il est peu probable que les différentes fasciculines connues actuellement soient utilisables dans le traitement de l'AD. En revanche elles pourraient être utilisées à des fins terroristes (Pita *et al.*, 2003).

## Conclusion

L'AD atteint un nombre extrêmement préoccupant de personnes âgées et fera encore de larges ravages dans les 50 prochaines années. Les AChEI ont été les premières molécules proposées pour le traitement de cette maladie. Ils permettent de compenser le premier déficit biochimique identifié (atteinte cholinergique) pendant quelque temps. Comme nous l'avons déjà rappelé, les médicaments qui sont actuellement sur le marché sont limités par leurs effets secondaires et la perte de leur activité au cours du temps. Les recherches se poursuivent (Tanzi, 2008; cf revue de Pagès *et al.*, 2009b) et un certain nombre d'entre elles visent à empêcher la synthèse et l'agrégation du peptide bêta-amyloïde à l'origine de la cascade amyloïde conduisant à la mort neuronale. Plusieurs molécules sont déjà en phase d'études cliniques. La mise au point de « dual binding site AChEI » (voir ci-dessus) a relancé la recherche d'un AChEI idéal d'origine naturelle. Depuis notre revue de 2009a, de nombreuses plantes ont encore révélé leur potentiel d'AChEI. Dans la présente revue, nous avons montré que de multiples autres sources naturelles d'AChEI existent: certains agissent à très faibles doses et sont spécifiques de l'AChE, ce qui permet d'espérer une moindre toxicité; d'autres agissent sur plusieurs cibles à la fois, ce qui permet d'en attendre une meilleure efficacité.

Toutefois, l'ensemble de ces travaux montre qu'il faudrait une meilleure cohésion entre les disciplines afin de prolonger la découverte d'un AChEI par des études pharmacologiques et toxicologiques, *in vivo*. Le plus souvent, en effet, les publications se limitent à la description de l'effet AChEI et donnent essentiellement lieu à des travaux de chimie ou à des études de mécanisme d'action. Or dans le vaste catalogue que nous avons proposé, il est plus que probable que certaines molécules devraient avoir un intérêt thérapeutique majeur.

Enfin, il faut garder aussi à l'esprit que ces molécules ont d'autres applications que le traitement de l'AD à un stade modéré. Nous les avons rappelées dans notre revue de 2009 (Pagès *et al.*, 2009b). Les AChEI réversibles sont utilisés pour le traitement de troubles périphériques (glaucome, myasthénie, curarisation résiduelle post-opératoire). On les utilise aussi comme antidote dans différentes intoxications. Ils conservent donc leur intérêt dans l'arsenal thérapeutique.

## Références

- Abó V, Viera L, Silveira R, Dajas F (1989) Effects of local inhibition of *locus coeruleus* acetylcholinesterase by fasciculine in rats. *Neurosci Lett* **98**: 253-257
- Abramson SN, Radic Z, Manker D, Faulkner J, Taylor P (1989) Onchidal: a naturally occurring irreversible inhibitor of acetylcholinesterase with a novel mechanism of action. *Mol. Pharmacol* **36**: 349-354
- Ata A, Ackerman J, Bayoud A, Radhika P (2004) Bioactive Chemical Constituents of *Cladiella* species. *Helv Chim Acta* **87**: 592-597
- Barré L, Gourand F, Levacher V, Marsais F (2007) Maladie d'Alzheimer: inhibiteur de l'acétylcholinestérase, nouveau concept de médicament, apport de l'imagerie TEP. *Méd Nucl* **31**: 490-492
- Becher PG, Baumann HI, Gademann K, Jüttner F (2009) The cyanobacterial alkaloid nostocarboline: an inhibitor of acetylcholinesterase and trypsin. *J Appl Phycol* **21**: 103-110
- Becher PG, Beuchat J, Gademann K, Jüttner F (2005) Nostocarboline: isolation and synthesis of a new cholinesterase inhibitor from *Nostoc* 78-12A. *J Nat Prod* **68**: 1793-1795
- Bernard V, Krejci E (2008) Utilisation de la fasciculine-2, une toxine de venin de serpent, pour étudier l'acétylcholinestérase *in vivo*: avantages et inconvénients. In *Toxines et fonctions cholinergiques neuronales et non neuronales*. Benoit E, Goudey-Perrière F, Marchot P et Servent D (eds) pp 93-100. Publications de la SFET, Châtenay-Malabry, France, Epub on <http://www.sfet.asso.fr> (ISSN 1760-6004)
- Bolioli B, Castelló ME, Jerusalinsky D, Rubinstein M, Medina J, Dajas F (1989) Neurochemical and behavioral correlates of unilateral striatal acetylcholinesterase inhibition by fasciculine in rats. *Brain Res* **504**: 1-6
- Bonnard I, Jhaumeer-Lauloo SB, Bontemps N, Banaigs B, Aknin M (2010) New lobane and cembrane diterpenes from two comorian soft corals. *Mar. Drugs* **8**: 359-372
- Bourne Y, Taylor P, Marchot P (1995) Acetylcholinesterase inhibition by fasciculine: crystal structure of the complex. *Cell* **83**: 503-512.
- Bugni TS, Ireland CM (2003) Marine-derived fungi: a chemically and biologically diverse group of microorganisms. *Nat Prod Rep* **21**: 143-163
- Carlier PR, Du DM, Han YF, Liu J, Pang YP (1999) Potent, easily synthesized huperzine A-tacrine hybrid acetylcholinesterase inhibitors. *Bioorg Med Chem Lett* **9**: 2335-2338
- Camps P, Formosa X, Galeano C, Gómez T, Muñoz-Torrero D, Ramírez L, Viayna E, Gómez E, Isambert N, Lavilla R, Badia A, Clos MV, Bartolini M, Mancini F, Andrisano V, Bidon-Chanal A, Huertas O, Dafni T, Luque FJ (2010) Tacrine-based dual binding site acetylcholinesterase inhibitors as potential disease-modifying anti-Alzheimer drug candidates. *Chem Biol Interact* **187**: 411-415
- Cervenanský C, Engström A, Karlsson E (1995) Role of arginine residues for the activity of fasciculine. *Eur J Biochem* **229**: 270-275
- Chen JW, Ling KH (1999) Territrems: naturally occurring specific irreversible inhibitors of acetylcholinesterase. *J Biomed Sci* **3**: 54-58
- Chen JW, Luo YL, Hwang MJ, Peng FC, Ling KH (1999) Territrein B, a tremorgenic mycotoxin that inhibits acetylcholinesterase with a noncovalent yet irreversible binding mechanism. *J Biol Chem* **274**: 34916-34923
- Chiang YM, Lee KH, Sanchez JF, Keller NP, Wang CC (2009) Unlocking fungal cryptic natural products. *Nat Prod Commun* **4**: 1505-1510
- Cho KM, Kim WG, Lee CK, Yoo ID (2003) Terreulactones A, B, C, and D: novel acetylcholinesterase inhibitors produced by *Aspergillus terreus*. I. Taxonomy, fermentation, isolation and biological activities. *J Antibiot (Tokyo)* **56**: 344-350
- Choi BW, Ryu G, Park SH, Kim ES, Shin J, Roh SS, Shin HC, Lee BH (2007) Anticholinesterase activity of plastoquinones from *Sargassum sagamianum*: lead compounds for Alzheimer's disease therapy. *Phytother Res* **21**: 423-426
- Codd GA (2000) Cyanobacterial toxins, the perspective of water quality, and the prioritisation of eutrophication control. *Ecol Engl* **16**: 51-60
- Cometa MF, Lorenzini P, Fortuna S, Volpe MT, Meneguz A, Palmery M (2005) *In vitro* inhibitory effect of aflatoxin B1 on acetylcholinesterase activity in mouse brain. *Toxicology* **206**: 125-135
- Cook WO, Beasley VR, Dahlem AM, Dellinger JA, Harlin KS, Carmichael WW (1988) Comparison of effects of anatoxin-a(s) and paraoxon, physostigmine and pyridostigmine on mouse brain cholinesterase activity. *Toxicol* **26**: 750-753
- Cook WO, Beasley VR, Lovell RA, Dahlem AM, Hooser SB, Mahmood MA, Carmichael WW (1989) Consistent inhibition of peripheral cholinesterases by anatoxins from the fresh water cyanobacterium *Anabaena flos-aquae*: studies in ducks, swine, mice and a steer. *Environ Toxicol Chem* **8**: 915-922
- Cook WO, Dahlem AM, Harlin KS, Beasley VR, Hooser SB, Haschek WM, Carmichael WW (1991) Reversal of cholinesterase inhibition and clinical signs and the postmortem findings in mice after intraperitoneal administration of anatoxin-a(s), paraoxon or pyridostigmine. *Vet Hum Toxicol* **33**: 1-4
- Coyle JT, Price DL, De Long MR (1983) Alzheimer's disease: a disorder of cortical cholinergic innervation. *Science* **219**(4589): 1184-1190
- Dajas F, Bolioli B, Castello ME, Silveira R (1987) Rat striatal acetylcholinesterase inhibition by fasciculine (a polypeptide from green mamba snake venom). *Neurosci Lett* **77**: 87-91
- Dajas F, Silveira R, Costa G, Castello ME, Jerusalinsky D, Medina J, Levesque D, Greenfield S (1993) Differential cholinergic and non-cholinergic actions of acetylcholinesterase in the *substantia nigra* revealed by fasciculine-induced inhibition. *Brain Res* **616**: 1-5
- Devic E, Li D, Dauta A, Henriksen P, Codd GA, Marty JL, Fournier D (2002) Detection of anatoxin-a(s) in environmental samples of cyanobacteria by using a biosensor with engineered acetylcholinesterases. *Appl Environ Microbiol* **68**: 4102-4106
- Dittmann E, Wiegand C (2006) Cyanobacterial toxins: occurrence, biosynthesis and impact on human affairs. *Mol Nutr Food Res* **50**: 7-17
- Dowd PF, Peng FC, Chen JW, Ling KH (1992) Toxicity and anticholinesterase activity of the fungal metabolites territrems to the corn earworm, *Helicoverpa zea*. *Entomol Exp Appl* **65**: 57

- Du DM, Carlier PR (1994) Development of bivalent acetylcholinesterase inhibitors as potential drugs for Alzheimer's disease. *Curr Pharm Design* **10**: 3141-3156
- Dunlop RW, Wells RJ (1979) Isolation of some novel diterpenes from a soft coral of the genus *Lobophytum*. *Aust J Chem* **32**: 1345-1351
- Ellis JM (2005) Cholinesterase inhibitors in the treatment of dementia. *J Am Osteopath Assoc* **105**: 145-158
- Essien JP (2004) Insecticidal potential of an orally administered metabolic extract of *Aspergillus niger* on *Chrysoma chloropyga* (Green bottle fly) larvae. *J Appl Sci Environ Management* **8**: 45-48
- Falkenstein RJ, Peña C (1997) Synthetic peptides derived from the central loop of fasciculins: structural analysis and evaluation as inhibitors of acetylcholinesterase. *Biochim Biophys Acta* **1340**: 143-151
- Faulkner DJ (2000) Marine natural products. *Nat Prod Rep* **17**: 7-55
- Ferchmin PA, Pagán OR, Ulrich H, Szeto AC, Hann RM, Eterović VA (2009) Actions of octocoral and tobacco cembranoids on nicotinic receptors. *Toxicon* **54**: 1174-1182
- Galdeano C, Viyana E, Arroyo P, Bidon-Chanal A, Ramon Blas J, Munoz-Torres D, Javier Luque F (2010). Structural determinants of the multifunctional profile of dual binding site acetylcholinesterase inhibitors as anti-Alzheimer agents. *Curr Pharm Des* **16**: 2818-2836
- Geissler T, Brandt W, Porzel A, Schlenzig D, Kehlen A, Wessjohann L, Arnold N (2010) Acetylcholinesterase inhibitors from the toadstool *Cortinarius infractus*. *Bioorg Med Chem* **18**: 2173-2177
- Giacobini E (2004) Cholinesterase inhibitors: new roles and therapeutic alternatives. *Pharmacol Res* **50**: 433-440
- Gutiérrez M, Theoduloz C, Rodríguez J, Lolas M, Schmeda-Hirschmann G (2005) Bioactive metabolites from the fungus *Nectria galligena*, the main apple canker agent in Chile. *J Agric Food Chem* **53**: 7701-7708
- Harel M, Kleywegt GJ, Ravelli RB, Silman I, Sussman JL (1995) Crystal structure of an acetylcholinesterase-fasciculin complex: interaction of a three-fingered toxin from snake venom with its target. *Structure* **3**: 1355-1366
- Hassanin N, Gabal MA (1990) Biological and chemical characterization of metabolites of *Fusarium moniliforme* isolates. *Vet Hum Toxicol* **32**: 536-540
- Henriksen P, Carmichael WW, An J, Moestrup O (1997) Detection of an anatoxin-a(s)-like anticholinesterase in natural blooms and cultures of cyanobacteria/blue-green algae from Danish lakes and in the stomach contents of poisoned birds. *Toxicon* **35**: 901-913
- Hermel JM, Stinnakre J (1993) Etude pharmacologique d'un nouvel agent anticholinestérasique: la fasciculine-1 vers une nouvelle approche du traitement des myasthénies; contribution à l'étude de la transmission synaptique chez les Vertébrés - « Pharmacological study of a new anticholinesterase peptide: the fasciculine-1; a new approach of myasthenic treatment; study of synaptic transmission in vertebrates ». Thèse nouveau doctorat N°: 93 PA11 2119
- Houghton PJ, Ren Y, Howes MJ (2006) Acetylcholinesterase inhibitors from plants and fungi. *Nat Prod Rep* **23**: 181-199
- Husain K, Singh R, Kaushik MP, Gupta AK (1996) Acute toxicity of synthetic *Gymnodinium brevetoxin* metabolite and its analogues in mice. *Ecotoxicol Environ Saf* **35**: 77-80
- Hyde EG, Carmichael WW (1991) Anatoxin-a(s), a naturally occurring organophosphate, is an irreversible active site-directed inhibitor of acetylcholinesterase (EC 3.1.1.7). *J Biochem Toxicol* **6**: 195-201
- Iwasa T, Harada S, Sato Y (1981) Miticidal antibiotics C-8030 B, C, D, and physostigmine produced by *Streptomyces pseudogriseolus* subsp. *iriomotensis* subsp. nov. *J Takeda Res Lab* **40**: 12-16
- Jang KH, Lee BH, Choi BW, Lee HS, Shin J (2005) Chromenes from the brown alga *Sargassum siliquastrum*. *J Nat Prod* **68**: 716-723
- Ji HF, Li XJ, Zhang HY (2009) Natural products and drug discovery. Can thousands of years of ancient medical knowledge lead us to new and powerful drug combinations in the fight against cancer and dementia? *EMBO Rep* **10**: 194-200
- Jinghui L, Yingbao Y, Yongcheng L, Zhiliang C, Xiongyu W (2004) [Effects of metabolites of mangrove fungus *Xylaria* sp. from South China Sea Coast on the activity of acetylcholinesterase *in vitro*] (en chinois) *Zhong Yao Cai* **27**: 261-264
- Karlsson E, Mbugua PM, Rodriguez-Ithurralde D (1984) Fasciculins, anticholinesterase toxins from the venom of the green mamba *Dendroaspis angusticeps*. *J Physiol (Paris)* **79**: 232-240
- Kem W, Soti F, Wildeboer K, Le Francois S, Mac Dougall K, Wei DQ, Chou KC, Arias HR (2006) The Nemertine Toxin Anabaseine and Its Derivative DMXBA (GTS-21): Chemical and Pharmacological Properties. *Mar Drugs* **4**: 255-273
- Kigoshi H, Kanematsu K, Uemura D (1999) Turbotoxins A and B, novel diiodotyramine derivatives from the Japanese gastropod *Turbo marmorata*. *Tetrahedron Lett* **40**: 5745-5748
- Kigoshi H, Kanematsu K, Yokota K, Uemura D (2000) Turbotoxins A and B, novel diiodotyramine derivatives from the Japanese gastropod *Turbo marmorata*. *Tetrahedron* **56**: 9063-9070
- Kim WG, Cho KM, Lee CK, Yoo ID (2002) Terreulactone A, a novel meroterpenoid with anti-acetylcholinesterase activity from *Aspergillus terreus*. *Tetrahedron Lett* **43**: 3197-3198
- Kim WG, Cho KM, Lee CK, Yoo ID (2003) Terreulactones A, B, C, and D: novel acetylcholinesterase inhibitors produced by *Aspergillus terreus*. II. Physico-chemical properties and structure determination. *J Antibiot (Tokyo)* **56**: 351-357
- Kim WG, Song NK, Yoo ID (2001) Quinolactacins A1 and A2, new acetylcholinesterase inhibitors from *Penicillium citrinum*. *J Antibiot* **54**: 831-835.
- Kriek NPJ, Marasas WFO (1979) Toxicity of *Diplodia macrospora* to laboratory animals. *Food Cosmet Toxicol* **17**: 233-236
- Kryger G, Harel M, Giles K, Toker L, Velan B, Lazar A, Kronman C, Barak D, Ariel N, Shafferman A, Silman I, Sussman JL (2000) Structures of recombinant native and E202Q mutant human acetylcholinesterase complexed with the snake-venom toxin fasciculin-II. *Acta Crystallogr D Biol Crystallogr* **56**: 1385-1394
- Kumar R, Gupta AK, Kaushik MP (2007) Novel and efficient synthesis of n,n-dialkylamino- and o-alkylphenyl-2-(1-alkylphenyl-2-oxopropylidene)phosphonohydrazido oximes - potential marine fish toxin analogues. Part 2. *Molecules* **12**: 1632-1640
- Kuno F, Otoguro K, Shiomi K, Iwai Y, Omura S (1996a) Arisugacins A and B, novel and selective acetylcholinesterase inhibitors from *Penicillium* sp. FO-4259. I. Screening, taxonomy, fermentation, isolation and biological activity. *J Antibiot (Tokyo)* **49**: 742-747

- Kuno F, Shiomi K, Otaguro K, Sunazuka T, Omura S (1996b) Arisugacins A and B, novel and selective acetylcholinesterase inhibitors from *Penicillium* sp. FO-4259. II. Structure elucidation. *J Antibiot* (Tokyo) **49**: 748-751
- Kurokawa T, Suzuki K, Hayaoka T, Nakagawa T (1993) Cyclophostin, acetylcholinesterase inhibitor from *Streptomyces lavendulae*. *J Antibiot* **46**: 1315-1318
- Langjae R, Bussarawit S, Yuenyongsawad S, Ingkaninan K, Piubrukarn A (2007) Acetylcholinesterase-inhibiting steroidal alkaloid from the sponge *Corticium* sp. *Steroids* **72**: 682-685
- Larréché S, Mion G, Clapson P, Debien B, Wybrecht D, Goyffon M (2008) Neurotoxines ophiennes. *Ann Fr Anesthes Réanim* **27**: 310-316
- Lee SS, Peng FC, Ling KH (1992) NMR assignments of territrems A, B, and C and the structure of MB2, the major metabolite of territrems B by rat liver microsomal fraction. *J Nat Prod* **55**: 251-255
- Lee TH, Park YI, Han YH (2006) Effect of mycelial extract of *Clavicornia pyxidata* on acetylcholinesterase and  $\beta$ -secretase activity *in vitro*. *J Microbiol* **44**: 502-507
- Lin Y, Wu X, Feng S, Jiang G, Luo J, Zhou S, Vrijmoed LL, Jones EB, Krohn K, Steingröver K, Zsila F (2001) Five unique compounds: xyloketal from mangrove fungus *Xylaria* sp. from the South China Sea coast. *J Org Chem* **66**: 6252-6256
- Ling KH (1994) Territrems, Tremorgenic Mycotoxins Isolated from *Aspergillus Terreus*. *Toxin Reviews* **13**: 243-252
- Ling KH, Liou HH, Yang CM, Yang CK (1984) Isolation, chemical structure, acute toxicity, and some physico-chemical properties of territrems C from *Aspergillus terreus*. *Appl Environ Microbiol* **47**: 98-100
- Ling KH, Yang CK, Peng FT (1979) Tremorgenic Mycotoxins Isolated of *Aspergillus terreus*. *Appl Environ Microbiol* **37**: 355-357
- Liston DR, Nielsen JA, Villalobos A, Chapin D, Jones SB, Hubbard ST, Shalaby IA, Ramirez A, Nason D, White WF (2004) Pharmacology of selective acetylcholinesterase inhibitors: implications for use in Alzheimer's disease. *Eur J Pharmacol* **486**: 9-17
- Lu W, Lin YC, She ZG, Du DS, Chan WL, Zheng ZH (2008) Paeciloxanthone, a new cytotoxic xanthone from the marine mangrove fungus *Paecilomyces* sp. (Tree 1-7). *J Asian Nat Prod Res* **10**: 133-137
- Mahmood NA, Carmichael WW (1986) The pharmacology of anatoxin-a(s), a neurotoxin produced by the freshwater cyanobacterium *Anabaena flos-aquae* NRC 525-17. *Toxicon* **24**: 425-434
- Mahmood NA, Carmichael WW (1987) Anatoxin-a(s), an anticholinesterase from the cyanobacterium *Anabaena flos-aquae* NRC-525-17. *Toxicon* **25**: 1221-1227
- Mahmood NA, Carmichael WW, Pfahler D (1988) Anticholinesterase poisonings in dogs from a cyanobacterial (blue-green algae) bloom dominated by *Anabaena flos-aquae*. *Am J Vet Res* **49**: 500-503
- Marchot P (1999) L'interaction fasciculine-acetylcholinesterase. *J Soc Biol* **193**: 505-508
- Marchot P, Khélif A, Ji YH, Mansuelle P, Bougis PE (1993) Binding of <sup>125</sup>I-fasciculine to rat brain acetylcholinesterase. The complex still binds diisopropyl fluorophosphate. *J Biol Chem* **268**: 12458-12467
- Marchot P, Prowse CN, Kanter J, Camp S, Ackermann EJ, Radić Z, Bougis PE, Taylor P (1997) Expression and activity of mutants of fasciculine, a peptidic acetylcholinesterase inhibitor from mamba venom. *J Biol Chem* **272**: 3502-3510
- Martinez GA, Alonso GD, Dorronsoro DI, Garcia PE, Austria LC, Usan EP, Del MMM, Median PM (2005) Marine compounds with calcium channel blocking properties for Alzheimer's disease treatment. *European Patent* EP 1609783
- Martinez GA (2008) Medicinal Chemistry of Alzheimer's Disease. *Transworld Research Network* 978-81-7895-342-7
- Matsumoto M, Fujiwara M, Mori A, Robin Y (1977) Effet des dérivés guanidiques sur la choline acétylase et sur l'acétylcholinesterase du cerveau de lapin. *Compt Rend Soc Biol* **171**: 1226-1229
- Mayer AMS, Glaser KB, Cuevas, C, Jacobs RS, Kem W, Little RD, McIntosh JM, Newman DJ, Mayer AMS, Potts BC, Shuster DE (2010) The odyssey of marine pharmaceuticals: a current pipeline perspective. *Trends Pharmacol Sci* **31**: 255-265
- McGlacken GP, Fairlamb IJ (2005) 2-Pyrone natural products and mimetics: isolation, characterisation and biological activity. *Nat Prod Rep* **22**: 369-385
- Mohammed YS, Luckner M (1963) The structure of cyclophenin and cyclophenol, metabolic products from *Penicillium cyclopium* Westling and *Penicillium viridicatum* Westling. *Tetrahedron Lett* **28**: 1953-1958
- Monserrat JM, Yunes JS, Bianchini A (2001) Effects of *Anabaena spiroides* (Cyanobacteria) aqueous extracts on the acetylcholinesterase activity of aquatic species. *Environ Toxicol Chem* **20**: 1228-1235
- Muñoz-Ruiz P, Rubio L, García-Palomero E, Dorronsoro I, del Monte-Millán M, Valenzuela R, Usán P, de Austria C, Bartolini M, Andrisano V, Bidon-Chanal A, Orozco M, Luque FJ, Medina M, Martínez A (2005) Design, synthesis, and biological evaluation of dual binding site acetylcholinesterase inhibitors: new disease-modifying agents for Alzheimer's disease. *J Med Chem* **48**: 7223-7233
- Murao S, Hayashi H (1986) Physostigmine and N8-norphysostigmine, insecticidal compounds, from *Streptomyces* sp. *Agric Biol Chem* **50**: 523-524
- Myung CS, Shin HC, Bao HY, Yeo SJ, Lee BH, Kang JS (2005) Improvement of memory by dieckol and phlorofucofuroeckol in ethanol-treated mice: possible involvement of the inhibition of acetylcholinesterase. *Arch Pharm Res* **28**: 691-698
- Natarajan S, Shanmugiahthevar KP, Kasi PD (2009) Cholinesterase inhibitors from *Sargassum* and *Gracilaria gracilis*: seaweeds inhabiting South Indian coastal areas (Hare Island, Gulf of Mannar). *Nat Prod Res* **23**: 355-369
- Nordberg A (1999) PET studies and cholinergic therapy in Alzheimer's disease. *Revue neurologique* **155**: SUP4: 4S53-4S63
- Neumann R, Peter HH (1987) Insecticidal organophosphates: nature made them first. *Experientia* **43**: 1235-1237
- Nukoolkarn VS, Saen-Oon S, Rungrotmongkol T, Hannongbua S, Ingkaninan K, Suwanborirux K (2008) Petrosamine, a potent anticholinesterase pyridoacridine alkaloid from a Thai marine sponge *Petrosia* n. sp. *Bioorg Med Chem* **16**: 6560-6567
- Odrizola E, Odeon A, Canton G, Clemente G, Escande A (2005) *Diplodia maydis*: a cause of death in cattle in Argentina. *New Zealand Vet J* **53**: 160-161
- Ogata K, Ueda K, Nagasawa T, Tani Y (1974) A cholinesterase inhibitor produced by *Aspergillus terreus*. *J Antibiot* **27**: 343-345
- Oliveira CM, Silva GH, Regasini LO, Zanardi LM, Evangelista A, Young MC, Bolzani VS, Araujo AR (2009) Bioactive metabolites produced by *Penicillium* sp. 1 and sp. 2, two endophytes associated with *Alibertia macrophylla* (Rubiaceae). *Z Naturforsch C* **64**: 824-830

- Omura S, Kuno F, Otoguro K, Sunazuka T, Shiomi K, Masuma R, Iwai Y (1995) Arisugacin, a novel and selective inhibitor of acetylcholinesterase from *Penicillium* sp. FO-4259. *J Antibiot* (Tokyo) **48**: 745-746
- Onodera H, Oshima Y, Henriksen P, Yasumoto T (1997) Confirmation of anatoxin-a(s), in the cyanobacterium *Anabaena lemmermannii*, as the cause of bird kills in Danish lakes. *Toxicon* **35**: 1645-1648
- Orhan I, Sener B (2003) Acetylcholinesterase inhibitors from natural resources. *FABAD J Pharm Sci* **28**: 51-58
- Otoguro K, Kuro F, Omura S (1997) Arisugacins, selective acetylcholinesterase inhibitors of microbial origin. *Pharmacol Ther* **76**: 45-54
- Otoguro K, Shiomi K, Yamaguchi Y, Arai N, Sunazuka T, Masuma R, Iwai Y, Omura S (2000) Arisugacins C and D, novel acetylcholinesterase inhibitors and their related novel metabolites produced by *Penicillium* sp. FO-4259-11. *J Antibiot* (Tokyo) **53**: 50-57
- Pagès N, Breton P, Goudey-Perrière F (2009a) Characterization of new phytotoxins targeting cholinesterases: a potential therapeutic use in Alzheimer's disease? In *Toxines et signalisation*. Benoit E, Goudey-Perrière F, Marchot P et Servent D (eds) pp 109-122. Publications de la SFET, Châtenay-Malabry, France, Epub on <http://www.sfet.asso.fr> (ISSN 1760-6004)
- Pagès N, Goudey-Perrière F, Breton P (2009b) Effets thérapeutiques, antidotiques, antiparasitaires et toxiques des inhibiteurs de l'acétylcholinestérase: importance des phytotoxines et de leurs dérivés. In *Toxines et signalisation*. Benoit E, Goudey-Perrière F, Marchot P et Servent D (eds) pp 85-96. Publications de la SFET, Châtenay-Malabry, France, Epub on <http://www.sfet.asso.fr> (ISSN 1760-6004)
- Pagès N, Goudey-Perrière F, Breton P (2009c). L'huperzine A, un inhibiteur prometteur de l'acétylcholinestérase. In *Toxines et signalisation*. Benoit E, Goudey-Perrière F, Marchot P et Servent D (eds) pp 97-108. Publications de la SFET, Châtenay-Malabry, France, Epub on <http://www.sfet.asso.fr> (ISSN 1760-6004)
- Pagès N, Goudey-Perrière F, Chamorro G (2004) Toxicologie des Aflatoxines. Implications cliniques. In *Envenimations, intoxications* (Goudey-Perrière F, Benoit E, Puisieux-Dao S, Bon C). Ed Tec Doc Lavoisier, Paris, 79-91
- Paleari L, Trombino S, Falugi C, Gallus L, Carlone S, Angelini C, Sepcic K, Turk T, Faimali M, Noonan DM, Albin A (2006) Marine sponge-derived polymeric alkyldipyridinium salts as a novel tumor haemotherapeutic targeting the cholinergic system in lung tumors. *Int J Oncol* **29**: 1381-1388
- Parvatkar RR, D'Souza C, Tripathi A, Naik CG (2009) Aspernolides A and B, butenolides from a marine-derived fungus *Aspergillus terreus*. *Phytochem* **70**: 128-132
- Pita R, Anadon A, Martinez-Larranaga MR (2003) Neurotoxins with anticholinesterase activity and their possible use as warfare agents. *Med Clin* **121**: 511-517
- Rabie CJ, Van Rensburg SJ, Kriek NPJ, Lubben A (1977) Toxicity of *Diplodia maydis* to laboratory animals. *Appl Environ Microbiol* **34**: 111-114
- Rahman MF, Rao SK, Achar PN (2002) Effect of diplodiatoxin (*Stenocarpella maydis*) on some enzymatic profiles in male and female rats. *Ecotoxicol Environ Saf* **52**: 267-272
- Rao SK, Achar PN (2001) Screening and *in vitro* production of diplodiatoxin from the isolates of *Stenocarpella maydis* and its toxigenic effect on bacterial strains. *Indian J Exp Biol* **39**: 1243-1248
- Rao SK, Achar PN, Rahman MF (2003) Biochemical changes induced in liver and serum of diplodiatoxin (*Stenocarpella maydis*) treated male and female rats. *Drug Chem Toxicol* **26**: 231-243
- Riet-Corea F, Mendez MC, Schild AL (1993) Toxicity of *Diplodia maydis* (Diplodiosis). Intoxicaciones por plantas e micotoxinas en animales domesticos. Editorial Agropecuaria Hemisferio Sur SRL, Montevideo, Uruguay, pp. 142-145.
- Rodrigues KF, Costa GL, Carvalho MP, Epifanio R de A (2005) Evaluation of extracts produced by some tropical fungi as potential cholinesterase inhibitors. *World J Microbiol Biotechnol* **21**: 1617-1621
- Rodríguez-Ithurrealde D, Silveira R, Barbeito L, Dajas F (1983) Fasciculins, a powerful anticholinesterase polypeptide from *Dendroaspis angusticeps* venom. *Neurochem Int* **5**: 267-274
- Rodríguez-Ithurrealde D, Vincent O (1994) Fasciculins, enzyme site-directed polypeptides, as motor neuron research tools. *J Neurol Sci* **124 suppl**: 54-55
- Rosini M, Simoni E, Bartolini M, Cavalli A, Ceccarini L, Pascu N, McClymont DW, Tarozzi A, Bolognesi ML, Minarini A, Tumiatti V, Andrisano V, Mellor IR, Melchiorre C (2008) Inhibition of Acetylcholinesterase,  $\beta$ -Amyloid Aggregation, and NMDA Receptors in Alzheimer's Disease: A Promising Direction for the Multi-target-Directed Ligands Gold Rush. *J Med Chem* **51**: 4381-4384
- Ryu G, Park SH, Kim ES, Choi BW, Ryu SY, Lee BH (2003) Cholinesterase inhibitory activity of two farnesylacetone derivatives from the brown alga *Sargassum sagamianum*. *Arch Pharm Res* **26**: 796-799
- Saleem M, Ali MS, Hussain S, Jabbar A, Ashraf M, Lee YS (2007) Marine natural products of fungal origin. *Nat Prod Rep* **24**: 1142-1152
- Sangnoi Y, Sakulkeo O, Yuenyongsawad S, Kanjana-Opas A, Ingkaninan K, Plubrukarn A, Suwanborirux K (2008) Acetylcholinesterase-inhibiting activity of pyrrole derivatives from a novel marine gliding bacterium, *Rapidiithrix thailandica*. *Mar Drugs* **6**: 578-586
- Sekhar Rao KC, Divakar S, Karanth NG, Sattur AP (2001) 14-(2',3',5'-trihydroxyphenyl)tetradecan-2-ol, a novel acetylcholinesterase inhibitor from *Chrysosporium* sp. *J Antibiot* (Tokyo) **54**: 848-849
- Sepčić K, Kaufenstein S, Mebs D, Turk T (2010) Biological activities of aqueous and organic extracts from tropical marine sponges. *Mar Drugs* **8**: 1550-1566
- Sepčić K, Mancini I, Vidic I, Jovan U, Frassanito R, Pietra F, Macek P, Turk T (2001) Antibacterial and anticholinesterase activities of aplysamine-4, a bromotyrosine-derived metabolite of a Red Sea marine sponge. *J Nat Toxins* **10**: 181-191
- Sepčić K, Marcel V, Klæbe A, Turk T, Šuput D, Fournier D (1998) Inhibition of acetylcholinesterase by an alkyl pyridinium polymer from the marine sponge, *Reniera sarai*. *Biochem Biophys Acta* **1387**: 217-225
- Sepčić K, Turk T, Macek P (1998) Anticholinesterase activity of the fluorescent zoantid pigment, parazoanthoxanthin A. *Toxicon* **36**: 937-940
- Sharabi O, Peleg Y, Mashiach E, Vardy E, Ashani Y, Silman I, Sussman JL, Shifman JM (2009) Design, expression and characterization of mutants of fasciculins optimized for interaction with its target, acetylcholinesterase. *Protein Eng Des Sel* **22**, 641-648

- Shiomi K, Tomoda H, Otoguro K, Omura S (1999) Meroterpenoids with various biological activities produced by fungi. *Pure Appl Chem* **71**: 1059-1064
- Shivanandappa T, Sattur AZP, Shereen S, Divakar S, Karanth NKG (2006) Compound as cholinesterase inhibitor and its isolation from fungus *Sporotrichum* species. *Patent US* 7045648
- Solfrizzo M, Visconti A (1994) Anticholinesterase activity of the *Fusarium* metabolite visoltricin and its N-methyl derivative. *Toxic in vitro* **8**: 461-465
- Srisukchayakul P, Suwanachart C, Sangnoi Y, Kanjana-Opas A, Hosoya S, Yokota A, Arunpairojana V (2007) *Rapidithrix thailandica* gen. nov., sp. nov., a marine gliding bacterium isolated from samples collected from the Andaman sea, along the southern coastline of Thailand. *Int J Syst Evol Microbiol* **57** (Pt10): 2275-2279
- Strupi-Suput J, Turk T, Macek P, Suput D (1996) Pseudozoanthoxantin-like compound from *Parazoanthus axinellae adriaticus* inhibits acetylcholinesterase. *Pflugers Arch* **431**: R315-316
- Suganthy N, Karutha Pandian S, Pandima Devi K (2010) Neuroprotective effect of seaweeds inhabiting South Indian coastal area (Hare Island, Gulf of Mannar Marine Biosphere Reserve): Cholinesterase inhibitory effect of *Hypnea valentiae* and *Ulva reticulata*. *Neurosci Lett* **468**: 216-219
- Suput JS, Turk T, Macek P, Suput D (1996) Pseudozoanthoxantin-like compound from *Parazoanthus axinellae adriaticus* inhibits acetylcholinesterase. *Plügers Arch Eur J Physiol* **431**: R315-R316
- Tanzi RE (2008) Novel therapeutics for Alzheimer 's disease. *Neurotherapeutics* **5**: 377-380
- Teipel SJ, Flatz WH, Heinsen H, Bokde ALW, Schoenberg SO, Stöckel S, Dietrich O, Reiser MF, Möller HJ, Hampel H (2005) Measurement of basal forebrain atrophy in Alzheimer's disease using MRI. *Brain* **128**: 2626-2644
- Turk T, Frangež R, Sepčić K (2007) Mechanisms of Toxicity of 3-Alkylpyridinium Polymers from Marine sponge *Reniera sarai*. *Mar Drugs* **5**: 157-167
- Turk T, Mašek P, Šuput T (1995) Inhibition of acetylcholinesterase by a pseudozoanthoxanthin-like compound isolated from the zoanthid *Parazoanthus axinellae* (O. Schmidt). *Toxicon* **33**: 133-142
- van den Born HK, Radić Z, Marchot P, Taylor P, Tsigelny I (1995) Theoretical analysis of the structure of the peptide fasciculin and its docking to acetylcholinesterase. *Protein Sci* **4**: 703-715
- Visconti A, Solfrizzo M (1994) Isolation, characterization and biological activity of visoltricin, a novel metabolite of *Fusarium tricinctum*. *J Agric Food Chem* **42**: 195-199
- Yoo ID, Cho KM, Lee CK, Kim WG (2005) Isoterreulactone A, a Novel meroterpenoid with anti-acetylcholinesterase activity produced by *Aspergillus terreus*. *Bioorg Med Chem Lett* **15**: 353-356
- Zelík P, Lukesová A, Cejka J, Budesínský M, Havlíček V, Cegan A, Kopecký J (2010) Nostotrebin 6, a bis(cyclopentenedione) with cholinesterase inhibitory activity isolated from *Nostoc* sp. str. Lukesová 27/97. *J Enzyme Inhib Med Chem* **25**: 414-420
- Zelík P, Lukesová A, Voloshko LN, Stys D, Kopecký J (2009) Screening for acetylcholinesterase inhibitory activity in cyanobacteria of the genus *Nostoc*. *J Enzyme Inhib Med Chem* **24**: 531-536
- Zheng ZH, Dong YS, Zhang H, Lu XH, Ren X, Zhao G, He JG, Si SY (2007) Isolation and characterization of N98-1272 A, B and C, selective acetylcholinesterase inhibitors from metabolites of an actinomycete strain. *J Enzyme Inhib Med Chem* **22**: 43-49
-

## **The changing profile of marine toxins in Europe**

Amparo ALFONSO<sup>1\*</sup>, Paula RODRIGUEZ<sup>1</sup>, Paz OTERO<sup>1</sup>, Vitor VASCONCELOS<sup>2</sup>,  
Joana AZEVEDO<sup>2</sup>, Marisa SILVA<sup>2</sup>, Paulo VALE<sup>3</sup>, Panagiota KATIKOU<sup>4</sup>,  
Dimitrios GEORGANTELIS<sup>4</sup>, Jordi MOLGÓ<sup>5</sup>, Luis M. BOTANA<sup>1</sup>

<sup>1</sup> USC Departamento de Farmacología, Facultad de Veterinaria, 27002 Lugo, Spain ; <sup>2</sup> Centro Interdisciplinar de Investigação Marinha e Ambiental- CIIMAR/CIMAR. Rua dos Bragas 289, 4050-123 Porto, Portugal and Departamento de Biologia, Faculdade de Ciências, Universidade do Porto, Rua do Campo Alegre, 4169-007 Porto, Portugal ; <sup>3</sup> Instituto Nacional dos Recursos Biológicos – IPIMAR (INRB-IPIMAR), Av. Brasília, s/n, 1449-006 Lisboa, Portugal ; <sup>4</sup> National Reference Laboratory for Marine Biotoxins, Ministry of Rural Development and Food, 546 27 Thessaloniki, Greece ; <sup>5</sup> CNRS, Institut de Neurobiologie Alfred Fessard - FRC2118, Laboratoire de Neurobiologie et Développement – UPR3294, 1 avenue de la Terrasse, F-91198 Gif sur Yvette Cedex, France

\* Corresponding author ; Tel : +34 982 822 213 ; E-mail : [amparo.alfonso@usc.es](mailto:amparo.alfonso@usc.es)

---

### **Abstract**

Public health administrations are developing continuous monitoring programs to appropriately detect phycotoxins to prevent and reduce risks for consumers and also to minimize the economic impact caused by the presence of these substances in fishing and aquaculture products. The presence of both toxic microalgae and toxins in fish and seafood is monitored including those toxins and microalgae that imply a risk on the European coast. However due to the increasing traffic of people and goods, and also probably in relation to changes in sea temperature and conditions, in recent years toxins from warm waters have appeared in European coasts, but no risk for consumers has been assessed and neither control measures nor legal limits for these toxins have been established so far. Ciguatoxins (CTXs) family is a group of cyclic polyether molecules soluble in polar solvents produced by different *Gambierdiscus* strains of dinoflagellates. Herbivorous fish accumulate these toxins in their musculature and viscera after ingesting dinoflagellates. Epidemiological studies showed that CTX has been present in areas between 35° North and 35° South latitude, mainly Indo-pacific and Caribbean areas, but not in waters close to the European and the African continents. However, some recent episodes of ciguatera in Canary Islands and Mediterranean countries have been reported. Tetrodotoxin (TTX) usually exists as a mixture of its analogs (TTXs) in puffer fish. It was also detected in many other sea animals: gastropods, crabs and newts. Recently, several food poisoning incidents due to ingestion of toxic puffers and gastropods have occurred in Taiwan, Japan, China, but also in Europe. In this context, several samples of fish and shellfish from the Mediterranean and Atlantic coasts have been checked to evaluate the presence of ciguatoxins and tetrodotoxins. LC-MS and UPLC-MS methodology have been used to detect the presence of these toxins. TTX and different analogs have been found in gastropods and echinoderms from Portugal and in puffer fish from Greece. Four ciguatoxins have been detected in samples from *Seriola dumerilli* and *Seriola fasciata* captured in Madeira Islands. Therefore the presence of toxins from warm waters in European coast addresses a problem that should be taken into account in the next future.

### **Le profil modifié des toxines marines en Europe**

Les administrations de santé publique élaborent des programmes de surveillance continue pour détecter les phycotoxines afin de prévenir et réduire les risques pour les consommateurs et également minimiser l'impact économique provoqué par la présence de ces substances dans les produits de la pêche et l'aquaculture. La présence de micro-algues toxiques et de toxines dans les poissons et fruits de mer est surveillée, le long des côtes européennes. Cependant, en raison de l'augmentation du trafic des personnes et des biens, et probablement aussi par rapport aux changements de température de la mer et des conditions écologiques, des toxines ont fait leur apparition ces dernières années dans les eaux chaudes des côtes européennes. Néanmoins, le risque pour les consommateurs n'a pas été évalué et aucune mesure de contrôle ni de limites légales de ces toxines n'a été établie jusqu'à présent. La famille des ciguatoxines (CTXs) est un groupe de polyéthers cycliques, solubles dans les solvants polaires et produits par des souches différentes de dinoflagellés *Gambierdiscus*. Les poissons herbivores accumulent ces toxines dans leurs musculatures et viscères après l'ingestion des dinoflagellés. Les études épidémiologiques ont montré que la CTX a été présente dans les régions entre les latitudes 35° Nord et 35° Sud, principalement les régions de l'Indo-Pacifique et des Caraïbes, mais pas dans les eaux proches des continents européen et africain. Cependant, certains épisodes récents de ciguatera dans les îles Canaries et les pays méditerranéens ont été rapportés. La tétrodotoxine (TTX) est généralement présente sous la forme d'un mélange de



*ses analogues (TTXs) dans le poisson-globe. Elle a été également détectée dans de nombreux autres animaux marins: gastéropodes, crabes et tritons. Récemment, plusieurs cas d'intoxication alimentaire due à l'ingestion de poissons-globes toxiques et de gastéropodes ont eu lieu à Taiwan, au Japon, en Chine, mais aussi en Europe. Dans ce contexte, plusieurs échantillons de poissons et de crustacés de la Méditerranée et des côtes de l'Atlantique ont été étudiés pour évaluer la présence de ciguatoxines et tétrodoamines. Les méthodes de spectrométrie de masse couplée à la chromatographie liquide (LC-MS) et à la chromatographie liquide ultra performance (UPLC-MS) ont été utilisées pour détecter la présence de ces toxines. La TTX et différents analogues ont été trouvés chez les gastéropodes et échinodermes du Portugal et chez les poissons-globes de la Grèce. Quatre ciguatoxines ont été détectées dans des échantillons de *Seriola dumerili* et *Seriola fasciata* capturés dans les îles de Madère. Par conséquent, la présence de toxines dans les eaux chaudes de la côte européenne soulève un problème qui devrait être pris en compte dans un futur proche.*

**Keywords :** Biotoxins, ciguatoxins (CTXs), tetrodotoxin (TTX).

## Introduction

Harmful algal blooms (HABs) consist in the proliferation of marine microalgae which carries a harmful effect and in many cases great economic losses. These microorganisms are naturally present in the plankton at low concentrations. However, depending on the environmental conditions, they're able to rapidly multiply in dense blooms, which can even stain seawater with a characteristic color. These episodes previously regarded as sporadic and localized phenomena and restricted to certain geographic areas, have started to show up as recurrent and ubiquitous in any coast of the world and sometimes elicit great damage to the local fishing industry and also to the natural communities of marine organisms (Vieites and Cabado, 2008). The microalgae secrete phycotoxins, which are responsible for their toxic activity since they accumulate in the digestive organs of filter-feeding shellfish, zooplankton and herbivorous fishes. These toxins can produce human intoxications through the trophic chain. They're generally considered as secondary metabolites and therefore not essential to the basic metabolism and growth of the microorganism (Van Dolah, 2000).

Marine biotoxins are a wide and complex chemical group of compounds with different structure and different mechanism of action. Most of them are produced by microalgae even though some have their origin in different species of bacteria (Yasumoto, 2000). They can be classified as neurotoxic and non-neurotoxic compounds. The neurological effects are mediated by diverse and highly specific interactions with ion channels involved in neurotransmission and produce symptoms like ataxia, paralysis and respiratory failure, that can be accompanied or not, by other clinical manifestations. This group of compounds includes ciguatoxins (CTXs), brevetoxins (PbTX), amnesic toxins (ASP), azaspiracids (AZAs), cyclic imines as spirolides and gymnodimines, maitotoxins (MTX), gambierol, palitoxins, paralytic shellfish toxins (PSP) and tetrodotoxins (TTX). The geographical distribution of such toxins is very complex due to factors such as the increasing world trade, and also the proliferation of toxic organisms triggered by environmental changes in the sea. In general, PSP, ASP, AZAs and the cyclic imines have a world-wide distribution, while PbTX, MTX, gambierol, palitoxins, TTX and CTX are found in tropical and subtropical waters. However several toxic episodes due to some of these compounds have been described in the Mediterranean Sea (Aligizaki *et al.*, 2008; Aligizaki and Nikolaidis, 2008; Ciminiello *et al.*, 2006) and on the European Atlantic coasts (Pérez-Arellano *et al.*, 2005; Vale, 2008). Therefore marine biotoxins should be considered as a world health problem.

Most coastal countries have biotoxins monitoring programs developed to prevent and reduce risks for consumers health as well as to diminish their economical impact, since once fishes or shellfishes become contaminated, the strategies for biotoxins elimination are not very effective in most of the situations (Lago *et al.*, 2008). The toxins usually monitored are those that can be often found in coastal waters, while the rest of the toxins are not analyzed. It is then crucial to know if biotoxins from tropical or subtropical waters are present on the European coasts to assess the potential risk for human health. In the present paper, the presence of CTXs and TTXs in several samples collected in different European localizations is discussed.

## Ciguatoxins

CTXs, produced by different dinoflagellates of the genus *Gambierdiscus toxicus* (Litaker *et al.*, 2010), cause a syndrome characterized by gastrointestinal, neurological and cardiovascular symptoms called ciguatera or Ciguatoxin Food Poisoning (CFP). CFP is the most common intoxication due to marine biotoxins in the world, affecting more than 25.000 people every year (Inoue and Hiram, 2004), and seems to be most prevalent in the South Pacific region (Legrand *et al.*, 1989), although fatal cases are very rare. This intoxication is associated with the consumption of about 400 species of fish from tropical and subtropical areas contaminated with CTXs from Indian and Pacific Oceans and from the Caribbean Sea. *Gambierdiscus spp.* are also capable of producing other types of potent marine toxins, such as MTX, gambierol and several gambieric acids (Roeder *et al.*, 2009; Yasumoto, 2001). CFP symptoms begin with gastrointestinal disturbances such as nausea, vomiting, diarrhoea, and abdominal pain within 12 h after eating a toxic fish, and often abate within 24 h. Cardiovascular troubles such as bradycardia with hypotension may also be found during this acute period. From a few hours to 2 weeks after exposure, neurological symptoms as paresthesias, dysesthesias and hyperesthesias may appear.

The mechanism of action of these toxins involves voltage-gated sodium and potassium channels. Calcium channels seem to have also some relevant role (Dickey and Plakas, 2010).

CTXs group includes an assemblage of principal CTX and numerous closely related structural isomers and congeners. To date, approximately 20 Pacific CTXs and 2 Caribbean C-CTXs (plus several congeners and isomers) are fully structured even though this list continues to grow (Hamilton *et al.*, 2002; Hamilton *et al.*, 2009; Inoue and Hirama, 2004; Kumar-Roine *et al.*, 2008; Yasumoto, 2000). In addition, Indian Ocean CTXs (I-CTXs) were also reported (Hamilton *et al.*, 2002). Chemically, the CTXs are lipid-soluble polyether compounds, highly oxygenated, with few double bonds and thermally stable to heat (Hidalgo *et al.*, 2002). CFP is a food-borne disease endemic to tropical and subtropical coral reef regions of the world, often restricted between latitudes 35° North and 35° South. However the actual locations of toxic fish within this broad geographic range are discrete and heterogeneous since toxic episodes due to CTXs have been described in Canary Islands (Pérez-Arellano *et al.*, 2005), Madeira Arquipelago (Vale, 2008) while presence of *Gambierdiscus* spp. has already been reported in the Mediterranean Sea (Aligizaki *et al.*, 2008).

## Tetrodotoxins

TTX and its analogs (TTXs) are potent neurotoxins first isolated from puffer fish gonads, liver and skin. Unlike the rest of biotoxins that accumulate in fishery products, the TTXs are produced by symbiotic bacteria (Yotsu-Yamasita *et al.*, 2007); specifically *Shewanella algae*, *S. putrefaciens*, *Vibrio sp.*, *Pseudomonas sp.* and *Alteromonas tetraodonis*. These bacteria are accumulated in the subcutaneous mucus and intestine, releasing the TTX (Crocchi *et al.*, 2006; Noguchi *et al.*, 2006). These data were confirmed by the isolation of TTX-producing bacteria from different TTX-bearing animals like newts, goby, crab, octopus, starfish, gastropods, nemerteans and trumpet shellfish (Wu *et al.*, 2005). TTXs were originally described in the Indo-Pacific area, but have recently been found in fish from the Gulf of Mexico, California, Germany and the Mediterranean area. Due to their origin, these toxins probably have a world-wide distribution. TTX is a powerful toxin that blocks the voltage-gated sodium channels in excitable membranes. The symptoms associated with TTXs intoxication are numbness of lips and tongue, paresthesia of limbs and face, headache, intestinal symptoms (nausea, diarrhoea and vomit), increasing paralysis and impossibility of movement, unconsciousness, respiratory paralysis, convulsions and sometimes death.

Many cases of TTX-food poisoning are reported in South-Eastern Asia, Australia, Madagascar and the South Pacific. The most extensive data on TTX-poisoning come from Japan (Gessner and McLaughlin, 2008). In addition, TTXs intoxications have recently been reported in the eastern Mediterranean area and Spain due to pufferfish and trumpet shell consumptions (Bentur *et al.*, 2008; Fernández-Ortega *et al.*, 2010; Rodriguez *et al.*, 2008).

## Sample analysis

Several samples from fish and shellfish harvested in European coasts have been analyzed to clarify whether CTXs and TTXs, typical from tropical waters are an incoming problem in Europe.

Two species of fish, *Seriola fasciata* (Bloch, 1793) (*S. fasciata*), and *Seriola dumerili* (*S. dumerili*) caught at Selvagens Islands (Madeira Arquipelago, Portugal), were analyzed. Fishes from this genus were implicated in previously suspected ciguatera poisoning outbreaks in the Portuguese Madeira Arquipelago, in the North Atlantic Ocean. The samples analyzed had previously shown positive response to the Cigua Check® Fish Poison Test Kit (Oceanit) developed to detect CTXs in fish muscle (Gouveia *et al.*, 2009). Analyses were performed by using ultra-performance liquid chromatography coupled to mass spectrometry detection (UPLC-MS). The study was carried out in one section of the tail muscle of *Seriola fasciata* and in five parts of the body of *Seriola dumerili* (tail muscle, head, ventral muscle, mid muscle and liver). Before analysis, the samples were extracted and cleaned-up following a previously described protocol (Lewis *et al.*, 2009). UPLC-MS technique was optimized for detecting and quantifying CTXs (Otero *et al.*, 2010). The analysis was performed in an ACQUITY UPLC system coupled to a Xevo TQ MS mass spectrometer from Waters (Manchester, UK). Chromatographic separation and identification of CTXs were achieved in a Waters Acquity UPLC® BEH C<sub>18</sub> column (100 mm x 2.1, 1.7 µm) equipped with a 0.2 µm Acquity UPLC® in-line filter and inside the column oven at temperature of 30 °C. The mobile phase for analysis consisted of two components: acetonitrile/ water (95:5) (A) and water (B), both containing 50 mM formic acid and 2 mM ammonium formate. The chromatographic separation was performed by gradient elution: starting with 50% A for 2.5 min, then, increasing to 100 % A for 4.5 min. 100 % A were hold for 4.5 min and reducing afterwards to 50 % A over 0.1 min. This proportion was maintained 0.9 min until the next run. The mobile phase flow rate was 0.4 mL/min and the injection volume 10 µL. The MS method operated in positive ES+/ES capillary ionization mode. The capillary potential (V) was set at 2.5 kV; desolvation gas flow 850 L/h N<sub>2</sub>; desolvation temperature 350 °C; Cone gas flow 50 L/h N<sub>2</sub>; Collision gas flow 0 V; Source temperature 120 °C; Cone voltage 50 V; Collision gas: Ar at 4.5 e<sup>-3</sup> mbar. All analyses were performed in MS scan and Selected Ion Recording (SIR) mode. The data were acquired using Waters MassLynx™ software and processed using the TargetLynx™ Application Manager.

Calibration curves were obtained with CTX-3C standard. In order to calculate concentrations of compounds when no standards were available, it was assumed that related analogues would give a similar response than CTX-3C toxin. The samples were first analyzed in scan mass mode (*m/z* 1000-1500). In this case, two prominent molecules *m/z* 1040.6 and *m/z* 1141.6, and two small peaks *m/z* 1111.6, and *m/z* 1023.5 were found. Setting these masses and using the SIR UPLC mode, several chromatograms of these toxins were obtained, as shown in *Figure 1*. The CTXs molecules identified at these *m/z* molecules at retention time 4.18

minutes was CTX-1B, ion  $m/z$  1111.6 and at retention time 8.12 minutes was CTX-3C, ion  $m/z$  1023.5. At retention time 6.12 minutes, ion  $m/z$  1040.6, some CTX-3C toxin was identified, probably 51-OH-CTX-3C (Roeder *et al.*, 2009). Finally, at ion  $m/z$  1141.6 molecule and retention time 8.27 minutes could be any of C-CTX-1, C-CTX-2, I-CTX-1 or I-CTX-2 (no standards are available yet), in any case, it was a toxin from Caribbean or Indian area. Then, an estimation of the amount of CTX in each sample was calculated by comparing with CTX-3C standard and therefore the quantification of these toxins was provided in ng/g for each CTX as CTX-3C equivalents.

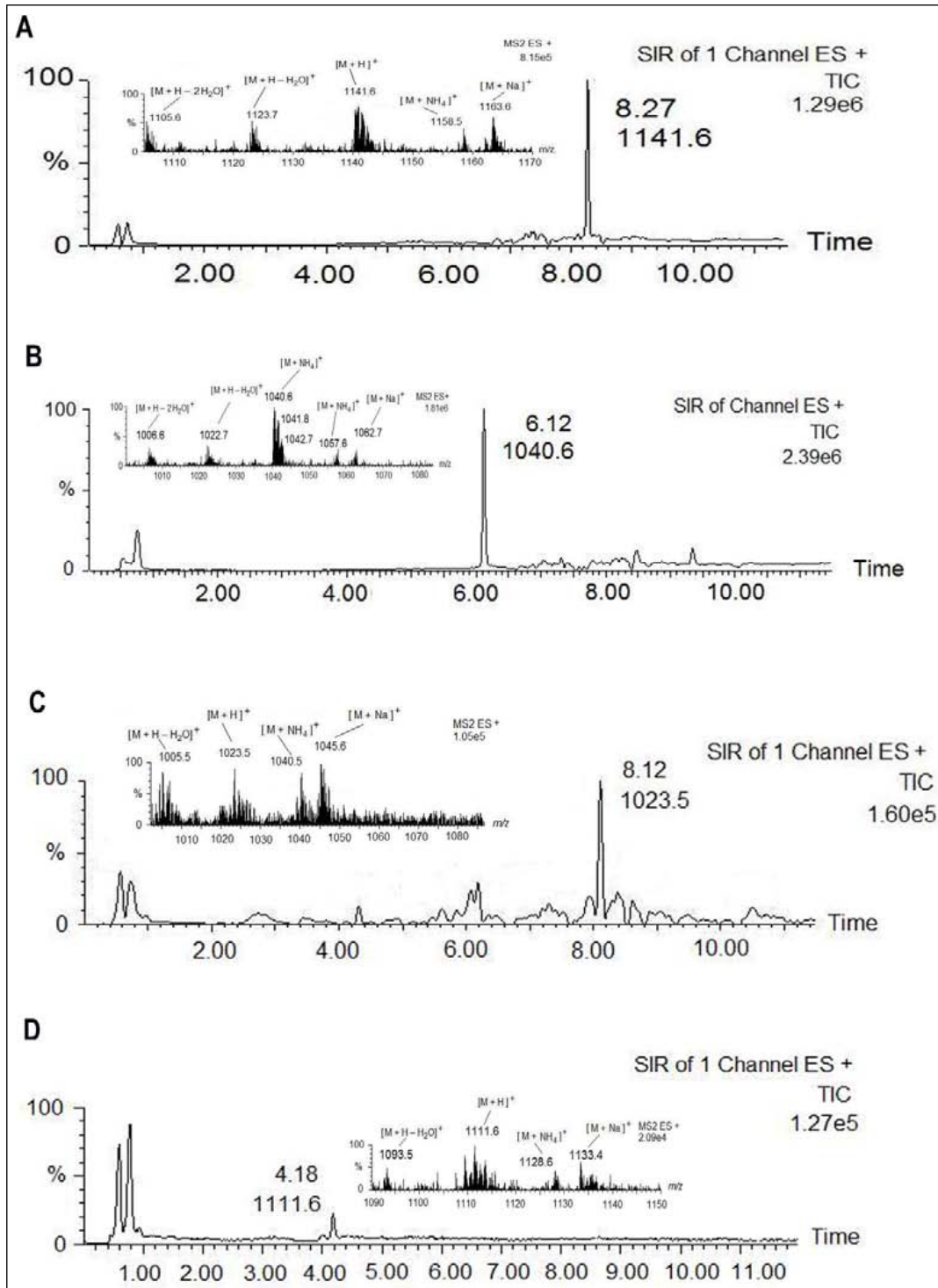

**Figure 1.** SIR and MS spectrum (inside) of CTXs in *S. dumereli* samples. (A) C/I-CTX-1/2 ( $m/z$  1141.6), (B) CTX-3C analogue (1040.6), (C) CTX-3C ( $m/z$  1023.5) and (D) CTX-1C ( $m/z$  1111.6).

**Figure 1.** SIR et spectre MS (insert) des CTXs dans des échantillons de *S. dumereli*. (A) C/I-CTX-1/2 ( $m/z$  1141.6), (B) Un analogue de CTX-3C (1040.6), (C) CTX-3C ( $m/z$  1023.5) et (D) CTX-1C ( $m/z$  1111.6).

As shown in Table 1, 1140.6  $m/z$  was the most abundant toxin in samples, while 1141.6  $m/z$ , CTX-1B and CTX-3C were present in very low levels. The total amount of CTXs in *S. fasciata* was 35.29 ng/g (measured in tail muscle), while in *S. dumerilli* the total CTX amount ranged from 54.35 ng/g in the head muscle to 33.29 ng/g in the ventral muscle. In summary, CTXs were present in these two species of fish and therefore the presence of these toxins in latitudes above 35° is confirmed for the first time.

**Table 1.** Amount of CTX analogs obtained by UPLC-MS in *S. fasciata* and *S. dumerilli* samples.

**Tableau 1.** Quantités d'analogues de CTX obtenues par UPLC-MS dans des échantillons de *S. fasciata* et *S. dumerilli*.

Species of fish	Part of fish	CTX-3C	CTX-1B	C/I-CTX-1	CTX-3C analogue	Total amount (ng/g)
<i>Seriola fasciata</i>	Tail	1.075	1.2	4.37	25.3	35.29
<i>Seriola dumerilli</i>	Tail	0.778	No detected	7.77	39.4	53.76
<i>Seriola dumerilli</i>	Mid	0.175	1.2	5.80	42.1	53.37
<i>Seriola dumerilli</i>	Ventral	0.35	0.125	2.00	28.7	33.29
<i>Seriola dumerilli</i>	Head	0.65	No detected	9.50	41.8	54.35
<i>Seriola dumerilli</i>	Liver	0.55	0.4	9.50	31.7	48.60

On the other hand, the presence of TTX and analogs was analyzed by high-performance liquid chromatography coupled to mass spectrometry detection (LC-MS) in several samples collected around Europe: a trumpet shell (24 cm. long) from the species *Charonia lampas lampas*, purchased in Malaga (Spain) market, several samples of *Charonia lampas* and *Murex trunculus* collected in the Algarve offshore coast and Ria Formosa, South coast of Portugal, some samples of *Nucella lapillus*, *Gibbula ummbilicalis* and *Paracentrotus lividus* harvested in different beaches from the North coast of Portugal, as well as different tissues from several pufferfish specimens from Greece.

*C. lampas*, *M. trunculus*, *N. lapillus* and *G. ummbilicalis* and the echinoderm *P. lividus* were boiled for 15 min and then were dissected in visceral mass and remaining tissues. The samples were extracted with 1% acetic acid and filtered through 0.45  $\mu$ m filters and then analyzed.

Several specimens of pufferfish *L. sceleratus* were initially dissected into muscle, liver, skin, gastrointestinal tract and gonads. The toxin extraction from each organ was carried out in acid medium (0.1% acetic acid) by heating in a boiling water bath (Katikou *et al.*, 2009). Then, the extracts were vacuum dried, re-dissolved in methanol and residues were removed through 0.45  $\mu$ m filters.

LC equipment was formed by a binary system of LC-10ADVP pumps, an autoinjector (SIL-10ADvp) with refrigerated rack, degasser, column oven, and a controller system from Shimadzu (Japan). This system was coupled to a mass spectrometer (MS) QTRAP-2000 instrument from Applied Biosystems, which consisted of a hybrid quadrupole-linear ion trap mass spectrometer equipped with an electrospray (ESI) source. The nitrogen generator was a Nitrocraft NCLC/MS from Air Liquide (Spain). The separation and identification of toxin was achieved in a Sunfire C18 column (*i.d.* 4.6 x 250 mm) from Waters, with temperature in the column oven kept at 20°C. The injection volume was 5  $\mu$ L. The two mobile phases were as follows: A: 1% acetonitrile; 20 mM heptafluorobutyric acid; 20 mM ammonium hydroxide; 10 mM ammonium formate (pH 4.0 with formic acid) and B: 5% acetonitrile; 20 mM heptafluorobutyric acid; 20 mM ammonium hydroxide; 10 mM ammonium formate (pH 4.0 with formic acid). The flow rate was set at 0.4 mL/min. The gradient program used to elute the toxins was 100% mobile phase A in the first 22 min, 100% mobile phase B for the next 3 min and hold 100% B for 15 min, and back to 100% A over the next 3 min before the next injection. Analyst software was used for instrument control, as well as data processing and analysis. Extracts were analyzed with the ESI interface operating in the positive ion mode using the following parameters: curtain gas (15), collision-activated dissociation gas (6), IonSpray voltage (4000 V), temperature (500°C), gas 1 (50), gas 2 (75); these parameters have been previously optimized using a TTX standard. The mass spectrometer was operating in Multiple Reaction Monitoring (MRM), analyzing two product ions per compound: one for quantification and the other for confirmation. Five ions at  $m/z$  272, 290, 302, 304 and 320 corresponding to the MH<sup>+</sup> ions of TTXs were detected. The transitions selected were: 5,6,11-trideoxyTTX: 272>254/162; 11-norTTX-6(S)-ol, and 11-norTTX-6(R)-ol: 290>272/162; 4,9-anhydroTTX: 302>256/162; 11-deoxyTTX and 5-deoxyTTX: 304>286/176; TTX, 6-epiTTX and 4-epiTTX: 320>302/162. Quantification was performed with the most abundant ion in the fragment spectra: 290 (11-norTTX-6(S)-ol and 11-norTTX-6(R)-ol), 302 (4,9-anhydroTTX), 304 (11-deoxyTTX and 5-deoxyTTX) and 320 (TTX, 6-epiTTX and 4-epiTTX). Samples were injected and several chromatograms with different analogs have been obtained. Figure 2 shows three representative chromatograms of *C. lampas*, *G. umbilicalis* and *L. sceleratus* obtained under Multiple Reaction Monitoring (MRM) operation.

As shown in Table 2, a high amount of TTX and analogs were detected in the gastrointestinal tract and liver of pufferfish analyzed, while only a low amount of TTX was located in the skin. The sample of *C. lampas* from a Spanish market had a high amount of TTX, 11-deoxyTTX and 5,6,11-trideoxy and a low amount of 4-epiTTX and 5-deoxyTTX. No trace of TTXs was found in *M. trunculus* and *N. lapillus* collected in different places of the

Portugal coast, while a small amount of 11-deoxyTTX and traces of TTX were detected in *G. umbilicalis* and *P. lividus* from the north coast of Portugal. Therefore TTXs are present in several marine products and can represent an emerging problem to European countries.

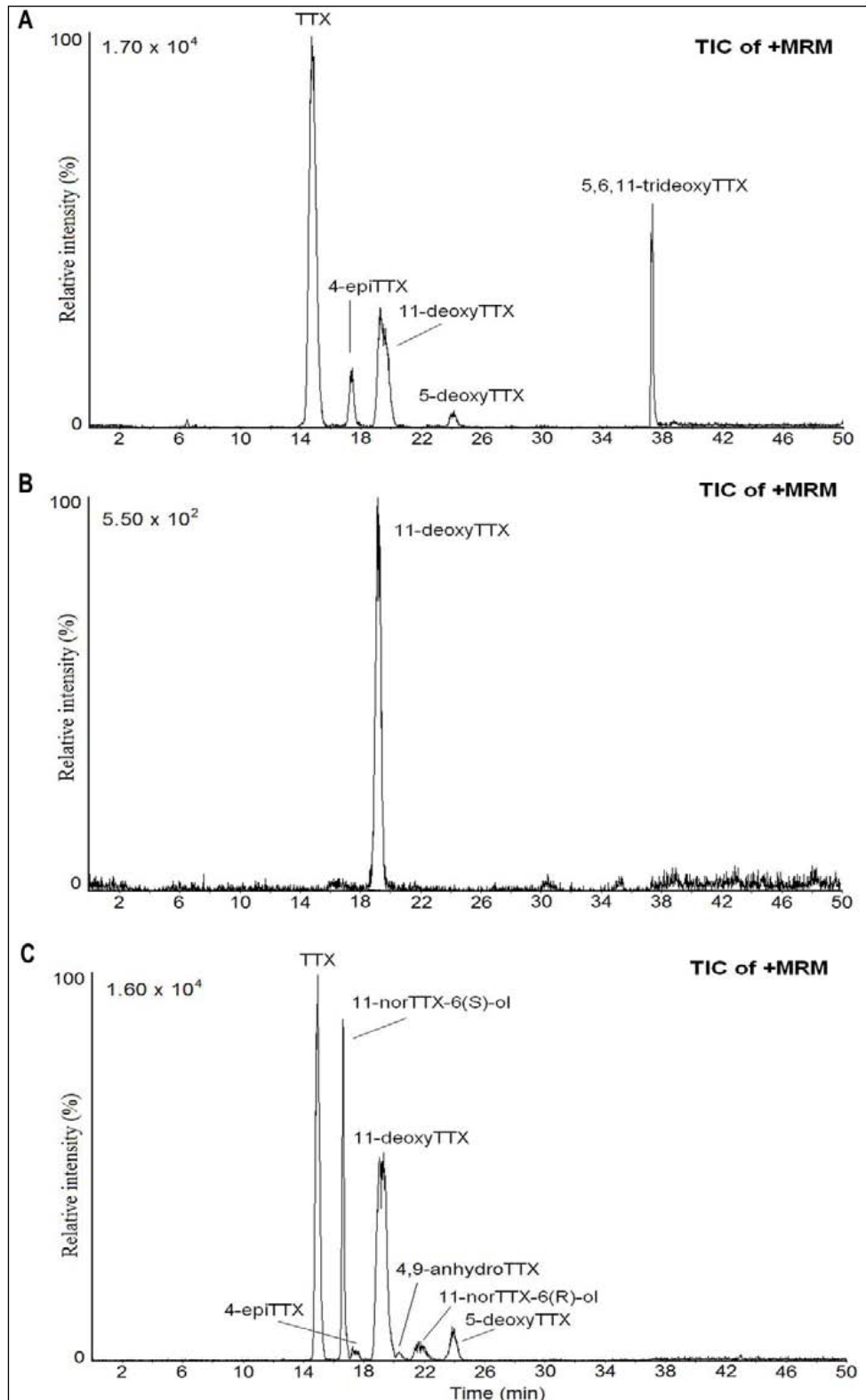

**Figure 2.** Mass chromatograms of LC-MS/MS obtained under MRM operation from samples of (A) *Charonia lampas* (viscera mass), (B) *Gibbula umbilicalis* and (C) pufferfish *Lagocephalus sceleratus*.

**Figure 2.** Chromatogrammes de masse (LC-MS/MS) obtenus par la méthode MRM à partir d'échantillons (A) de *Charonia lampas* (masse viscérale), (B) de *Gibbula umbilicalis* et (C) du poisson-globe *Lagocephalus sceleratus*.

**Table 2.** Amount of TTX and analogs obtained by LC-MS/MS in samples of: gastrointestinal (G.I.) tract, skin and liver from *Lagocephalus sceleratus* (Pufferfish) caught in the Southeast Aegean Sea (Greece), *Charonia lampas* (Gastropod) obtained from the Spanish market but caught in the South Coast of Portugal, *Murex trunculus* (Gastropod) from Ria Formosa (South Coast of Portugal), *Nucella lapillus* (Gastropod) from Póvoa do Varzim Marine (North of Portugal), *Gibbula umbilicalis* (Gastropod) from Memória Beach, Matosinhos (North of Portugal), and *Paracentrotus lividus* (Echinoderm) from Valadares Beach, Vila Nova de Gaia (North of Portugal).

**Tableau 2.** Quantités de TTX et d'analogues obtenues par LC-MS/MS dans des échantillons de: voies gastro-intestinales (G.I.), de peau et de foie de *Lagocephalus sceleratus* (poisson-globe) capturé dans le sud-est de la mer Egée (Grèce), *Charonia lampas* (Gastéropode) obtenu du marché espagnol mais pris dans la côte sud du Portugal, *Murex trunculus* (Gastéropode) de Ria Formosa (côte sud du Portugal), *Nucella lapillus* (Gastéropode) de la mer près de Povoia do Varzim (nord du Portugal), *Gibbula umbilicalis* (Gastéropode) de Memória Beach, (Matosinhos, nord du Portugal) et *Paracentrotus lividus* (Echinoderme) de Valadares Beach (Vila Nova de Gaia, nord du Portugal).

Samples	Location	Toxin amount (µg/g tissue)							
		TTX	4-epiTTX	4,9-anhydro TTX	11-deoxy TTX	5-deoxy TTX	11-norTTX-6(S)-ol	11-norTTX-6(R)-ol	5,6,11-trideoxy TTX
<i>L.sceleratus</i> G.I. tract	Greece	11.00	1.71	0.29	17.25	1.96	11.19	1.95	—
<i>L.sceleratus</i> Skin	Greece	0.13	—	—	—	—	—	—	—
<i>L.sceleratus</i> Liver	Greece	1.46	0.20	—	4.89	1.30	1.85	—	—
<i>C. lampas</i> Viscera mass	Spain-Portugal	60.20	6.36	—	20.60	2.24	—	—	10.34
<i>M. trunculus</i>	Portugal	—	—	—	—	—	—	—	—
<i>N. lapillus</i>	Portugal	—	—	—	—	—	—	—	—
<i>G. umbilicalis</i>	Portugal	—	—	—	0.11	—	—	—	—
<i>P. lividus</i>	Portugal	Traces	—	—	—	—	—	—	—

## Conclusion

Results presented in this paper demonstrate that both CTXs and TTXs have been detected in fish and shellfish caught in southern European waters. According to the European legislation fishery products derived from poisonous fish of several families (Tetraodontidae, molidae...) containing TTXs have to be removed from the market, as well as fishery products containing biotoxins such as ciguatera or other toxins dangerous to the human health (EC, 2004). However, no specific detection methods or detection limits is proposed for routinely monitoring of samples, neither in this regulation nor in the following (EC, 2005) Therefore these toxins from warm waters can represent a public health issue in the next future if their presence is relevant in products from these coasts.

**Acknowledgements.** We thank Dr Anne-Marie Legrand, Dr Mireille Chinain and the members of the Institut Territorial de Recherches Médicales Louis Malardé, Papeete, Tahiti, French Polynesia for kindly providing the Pacific ciguatoxin-1b sample standard used in this study. Dr M. Hiram and Dr Y. Ishihara from Department of Chemistry, Graduate School of Science, Tohoku University, Sendai 980-8578, Japan, for kindly providing the CTX-3C standard used in this study. Dr. Nuno Gouveia, Dra. Neide N. Gouveia, and Dr. João Delgado, from Direcção Regional de Pescas da Madeira, for supplying ciguateric fishes for analysis. This work was funded with the following grants: From Ministerio de Ciencia y Tecnología, Spain: AGL2007-60946/ALI, SAF2009-12581 (subprograma NEF), AGL2009-13581-CO2-01. From Xunta de Galicia, Spain: GRC 30/2006, and INCITE09 261 080 PR, PGDIT 07MMA006261PR, 2009/XA044 (Consell. Educación), 2008/CP389 (EPITOX, Consell. Innovación e Industria, programa IN.CI.TE.). From EU VI<sup>th</sup> Frame Program: IP FOOD-CT-2004-06988 (BIOCOP), and CRP 030270-2 (SPIES-DETOX). From EU VII<sup>th</sup> Frame Program: 211326 – CP (CONFIDENCE); STC-CP2008-1-555612 (Atlantox), 2009-1/117 Pharmatlantic.

## References

- Aligizaki K, Katikou P, Nikolaidis G, Panou A (2008) First episode of shellfish contamination by palytoxin-like compounds from *Ostreopsis* species (Aegean Sea, Greece). *Toxicon* **51**: 418-427
- Aligizaki K, Nikolaidis G (2008) Morphological identification of two tropical dinoflagellates of the genera *Gambierdiscus* and *Sinophysis* in the Mediterranean Sea. *J Biol Res -Thessaloniki* **9**: 75-82
- Bentur Y, Ashkar J, Lurie Y, Levy Y, Azzam ZS, Litmanovich M, Golik M, Gurevych B, Golani D, Eisenman A (2008) Lessepsian migration and tetrodotoxin poisoning due to *Lagocephalus sceleratus* in the eastern Mediterranean. *Toxicon* **52**: 964-968
- Ciminiello P, Dell'Aversano C, Fattorusso E, Forino M, Magno GS, Tartaglione L, Grillo C, Melchiorre N (2006) The Genoa 2005 outbreak. Determination of putative palytoxin in Mediterranean *Ostreopsis ovata* by a new liquid chromatography tandem mass spectrometry method. *Anal Chem* **78**: 6153-6159
- Croci L, Cozzi L, Suffredini E, Ciccaglioni G, Toti L, Milandri A (2006) Characterization of microalgae and associated bacteria collected from shellfish harvesting areas. *Harmful Algae* **5**: 266-274
- Dickey RW, Plakas SM (2010) Ciguatera: A public health perspective. *Toxicon* **56**: 123-136
- EC (2004) Regulation (EC) No 854/2004 of the European Parliament and of the Council of 29 April 2004 laying down specific rules for the organisation of official controls on products of animal origin intended for human consumption. (OJ L 226, 25.6.2004, p 83). *Off J Eur Union* L226/83-131

- EC (2005) Commission Regulation (EC) No 2074/2005 of 5 December 2005 laying down implementing measures for certain products under Regulation (EC) No 853/2004 of the European Parliament and of the Council and for the organisation of official controls under Regulation (EC) No 854/2004 of the European Parliament and of the Council and Regulation (EC) No 882/2004 of the European Parliament and of the Council, derogating from Regulation (EC) No 852/2004 of the European Parliament and of the Council and amending Regulations (EC) No 853/2004 and (EC) No 854/2004 (Text with EEA relevance). *Off J Eur Union* L338/27-59.
- Fernández-Ortega JF, Santos JM, Herrera-Gutiérrez ME, Fernández-Sánchez V, Loureo PR, Rancaño AA, Téllez-Andrade A (2010) Seafood Intoxication by tetrodotoxin: First case in Europe. *J Emerg Med*, in press
- Gessner BD, McLaughlin JB (2008) Epidemiologic impact of toxic episodes: neurotoxic toxins. In *Seafood and Freshwater Toxins - Pharmacology, Physiology, and Detection*. Botana LM (ed), pp 77-103. Taylor and Francis group: CRC Press
- Gouveia N, Delgado J, Gouveia N, Vale P (2009) Primeiro registo da ocorrência de episódios do tipo ciguaterico no arquipélago da Madeira. *X Reunion Ibérica sobre Fitoplancton Tóxico e Biotoxinas*, Lisboa, Portugal, 12-15/May/2009. 41.
- Hamilton B, Hurbungs M, Jones A, Lewis RJ (2002) Multiple ciguatoxins present in Indian Ocean reef fish. *Toxicon* **40**: 1347-1353
- Hamilton B, Whittle N, Shaw G, Eaglesham G, Moore MR, Lewis RJ (2010) Human fatality associated with Pacific ciguatoxin contaminated fish. *Toxicon* **56**: 668-673
- Hidalgo J, Liberona JL, Molgó J, Jaimovich E (2002) Pacific ciguatoxin-1b effect over Na<sup>+</sup> and K<sup>+</sup> currents, inositol 1,4,5-triphosphate content and intracellular Ca<sup>2+</sup> signals in cultured rat myotubes. *Br J Pharmacol* **137**: 1055-1062
- Inoue M, Hiram M (2004) Evolution of a practical total synthesis of ciguatoxin CTX3C. *Acc Chem Res* **37**: 961-968
- Katikou P, Georgantelis D, Sinouris N, Petsi A, Fotaras T (2009) First report on toxicity assessment of the Lessepsian migrant pufferfish *Lagocephalus sceleratus* (Gmelin, 1789) from European waters (Aegean Sea, Greece). *Toxicon* **54**: 50-55
- Kumar-Roine S, Matsui M, Chinain M, Laurent D, Pauillac S (2008) Modulation of inducible nitric oxide synthase gene expression in RAW 264.7 murine macrophages by Pacific ciguatoxin. *Nitric Oxide* **19**: 21-28
- Lago J, Reboreda A, Chapel MJ, Vieites JM, Cabado AG (2008) Study of the detoxification of marine toxins in mussels and scallops. *16<sup>th</sup> European Section Meeting of the International Society on Toxinology*. Leuven, 2008.
- Legrand AM, Litaudon M, Genthon JN, Bagnis R, Yasumoto T (1989) Isolation and some properties of ciguatoxin. *J Appl Phycol* **1**: 183-188
- Lewis RJ, Yang A, Jones A (2009) Rapid extraction combined with LC-tandem mass spectrometry (CREM-LC/MS/MS) for the determination of ciguatoxins in ciguateric fish flesh. *Toxicon* **54**: 62-66
- Litaker RW, Vandersea MW, Faust MA, Kibler SR, Nau AW, Holland WC, Chinain M, Holmes MJ, Tester PA (2010) Global distribution of ciguatera causing dinoflagellates in the genus *Gambierdiscus*. *Toxicon*, in press
- Noguchi T, Arakawa O, Takatani T (2006) TTX accumulation in pufferfish. *Comp Biochem Physiol Part D* **1**: 145-152
- Otero P, Pérez S, Alfonso A, Vale C, Rodríguez P, Gouveia NN, Gouveia NJD, Vale P, Hiram M, Ishihara Y, Molgó J, Botana LM (2010) First toxin profile of ciguateric fish in Madeira Arquipelago (Europe). *Anal Chem*, in press
- Pérez-Arellano JL, Luzardo OP, Pérez Brito A, Hernández Cabrera M, Zumbado M, Carranza C, Angel-Moreno A, Dickey RW, Boada LD (2005) Ciguatera fish poisoning, Canary Islands. *Emerg Infect Dis* **11**: 1981-1982
- Rodríguez P, Alfonso A, Vale C, Alfonso C, Vale P, Tellez A, Botana LM (2008) First toxicity report of tetrodotoxin and 5,6,11-trideoxyTTX in the trumpet shell *Charonia lampas lampas* in Europe. *Anal Chem* **80**: 5622-5629
- Roeder K, Erler K, Kibler S, Tester P, Van The H, Nguyen-Ngoc L, Gerdt G, Luckas B (2010) Characteristic profiles of Ciguatera toxins in different strains of *Gambierdiscus* spp. *Toxicon* **56**: 731-738.
- Vale P (2008) Ciguatera Fish Poisoning in Ilhas Selvagens (Madeira). *Journal National Reference Laboratories Annual Meeting*
- Van Dolah FM (2000) Diversity of marine and freshwater algal toxins. In *Seafood and Freshwater Toxins - Pharmacology, Physiology, and Detection*. Botana LM (ed), pp 19-44. Marcel Dekker: New York
- Vieites JM, Cabado AG (2008) Incidence of Marine Toxins on Industry Activity. In *Seafood and Freshwater Toxins - Pharmacology, Physiology, and Detection*. Botana LM (ed), pp 899-918. Taylor and Francis group: CRC Press
- Wu Z, Xie L, Xia G, Zhang J, Nie Y, Hu J, Wang S, Zhang R (2005) A new tetrodotoxin-producing actinomycete, *Nocardioopsis dassonvillei*, isolated from the ovaries of puffer fish *Fugu rubripes*. *Toxicon* **45**: 851-859
- Yasumoto T (2000) Historic considerations regarding seafood safety. In *Seafood and Freshwater Toxins - Pharmacology, Physiology, and Detection*. Botana LM (ed), pp 1-17. Marcel Dekker: New York
- Yasumoto T (2001) The chemistry and biological function of natural marine toxins. *Chem Rec* **1**: 228-242
- Yotsu-Yamasita M, Mebs D, Kwet A, Schneider M (2007) Tetrodotoxin and its analogue 6-epitetrodotoxin in newts (*Triturus* spp.; Urodela, Salamandridae) from southern Germany. *Toxicon* **50**: 306-309

## Rapid intraspecimen evolution of cone snail venom composition : multiplying pharmacological profiles ?

Daniel BIASS<sup>1\*</sup>, Sébastien DUTERTRE<sup>1#</sup>, Philippe FAVREAU<sup>1</sup>, Reto STÖCKLIN<sup>1</sup>

<sup>1</sup> Atheris Laboratories, case postale 314, CH-1233 Bernex, Geneva, Switzerland ; <sup>#</sup> Current address : Institute for Molecular Bioscience, University of Queensland, Brisbane, Australia

\* Corresponding author ; Tel : +41 (0)22 850 05 85 ; E-mail : [daniel.biass@atheris.ch](mailto:daniel.biass@atheris.ch)

### Abstract

The mechanism of action of conopeptides is primordial for cone snails as it conditions the prey envenomation. Surprising intraspecimen venom variations during a venom follow-up over a given duration displayed a completely different panel of components. These variations resulted in a different pharmacological mode of action. Such new or previously undetected molecules could be involved in prey capture (adaptive evolution), and could well be produced by other organs than the venom gland.

### Evolution intra-spécimen rapide de la composition du venin de cône : une multiplication des profils pharmacologiques ?

Le mécanisme d'action des conopeptides est essentiel pour les cônes marins, puisque cela conditionne la capture de leur proie. D'étonnantes variations intra-spécimen de la composition du venin ont été observées au cours du temps. Cela suggère une adaptabilité à l'environnement pouvant résulter en un éventail de composés totalement distincts et pourvus de propriétés pharmacologiques différentes. Ces molécules pourraient provenir d'autres organes que la glande à venin.

**Keywords :** Cone snail, *Conus consors*, mass spectrometry, peptidomics, venom, venomics.

### Introduction

Different pharmacological functions of conopeptides have now been brought to light over the past years and exploited to understand biochemical processes. These peptides have been used as biochemical and pharmacological tools and more recently as pharmaceuticals. They have been classified in different families according to their biological activities (Halai and Craik, 2009).

Each cone snail venom is made of a cocktail of hundreds of conopeptides. Their role in the prey capture is crucial for the cone snail's survival. The mode of action of these molecules has been classified in three groups: the "motor cabal", the "lightning-strike cabal" and finally the "nirvana cabal" (Olivera and Cruz, 2001). For the fish-hunting cone snails, the motor cabal and the lightning-strike cabal are essential as they act synergistically for prey capture. They elicit hyper- as well as hypo-excitability in the nervous system, which seems contradictory, but have in fact two well distinct physiological endpoints. On the one hand, the motor cabal potently inhibits neuromuscular transmission that causes slow and flaccid paralysis. On the other hand, the lightning-strike cabal provokes uncontrolled firing of nerve terminals, resulting in immediate tetanic paralysis.

### Venom profile evolution

During the follow-up of venom milked from several specimens of the piscivorous *Conus consors*, we noticed a quite astonishing intraspecimen venom variation in terms of molecular composition (Dutertre *et al.*, 2010).

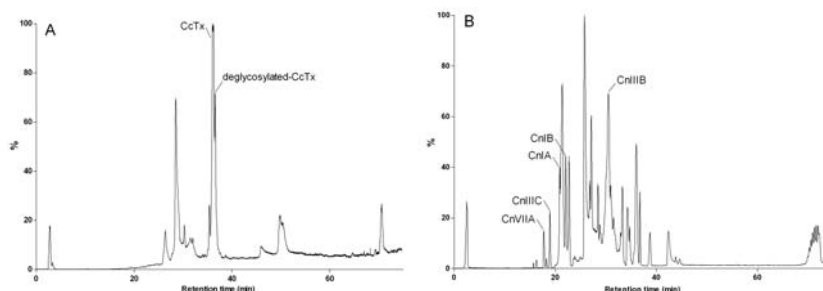

**Figure 1.** Typical LC-ESI-MS profile (A) of one *C. consors* specimen milked venom changed (B) in five months to an unusual profile.

**Figure 1.** Profil LC-ESI-MS du venin prélevé (A) typique de *C. consors*, et se changeant (B) en un profil inhabituel en cinq mois.



Indeed, the analysis of the venom at two different time points revealed two completely different sets of peptides (Figure 1). The mass list comparison between both profiles showed no overlap (except for the  $\geq 10'000$  Da mass range). The typical profile displayed only masses above 4'100 Da whereas the unusual profile revealed only masses below 4'100 Da. The CcTx, an excitatory peptide (Le Gall *et al.*, 1999), was the most abundant peptide in the typical profile but was absent in the unusual profile. On the contrary, the  $\alpha$ -,  $\mu$ -  $\omega$ -conopeptides (motor cabal toxins) were not detected in the typical profile, but were detected in high abundance in the unusual profile. In addition, the molecular profiles of the venom obtained by dissection of the venom duct of two specimens giving different milked venom profiles were identical, thus putting forward the possibility that other organs might be involved in the genesis and processing of the delivered venom.

### Differences in prey capture strategy

This molecular profile difference also modified the mode of action for the prey capture as observed on the live animal, revealing two different pharmacological activities. Upon prey envenomation, the typical profile (Figure 2A) induced a tetanic paralysis resulting in a typical curved shape of the fish with strong fasciculation, suggesting the presence of the CcTx. This toxin acts on neuronal voltage-gated sodium channels and increases nerve excitability probably by affecting the channel activation process. Concerning the unusual profile (Figure 2B), the effect was rapid with instant flaccid paralysis but without violent convulsions, a pharmacological effect reminiscent of curaremimetic toxins. Slight fasciculation was also present but without the typical curved shape observed in Figure 2A.



**Figure 2.** Pictures of fish capture by *C. consors* inducing (A) a tetanic paralysis or (B) a flaccid paralysis.

**Figure 2.** Vues d'une capture de poisson par *C. consors* produisant (A) une paralysie tétanique ou (B) une paralysie flasque.

### Discussion

The mode of action of the unusual profile presented the characteristics of a flaccid paralysis with slight fasciculation. Indeed,  $\alpha$ -,  $\mu$ - or  $\omega$ -conotoxins found in the unusual profile are expected to induce a major flaccid paralysis. However, since the main excitatory toxin CcTx is absent, the slight fasciculation implies that excitatory molecules under 4'100 Da remain to be identified in the venom. An alternative explanation could be the presence in trace amount of  $\delta$ -conotoxins in the injected venom, which are potent excitatory toxins well characterized only from *C. consors* dissected venom (Biass *et al.*, 2009). Recently, a family of conopeptides was shown to be specifically expressed in the salivary glands of *C. pulicarius* (Biggs *et al.*, 2008). Therefore, other organs should also be investigated as they could produce new interesting molecules absent from the venom gland's composition that could engender such effects.

**Acknowledgements.** This study has been performed as part of the CONCO cone snail genome project for health ([www.conco.eu](http://www.conco.eu)) funded by the European Commission within the 6th Framework Program (LIFESCIHEALTH-6 Integrated Project LSHB-CT-2007, contract number 037592). We are most grateful to the French Institute of Research for the Development (IRD), and to the governments of New Caledonia and French Polynesia for their support.

### References

- Biass D, Dutertre S, Gerbault A, Menou JL, Offord R, Favreau P, Stöcklin R (2009) Comparative proteomic study of the venom of the piscivorous cone snail *Conus consors*. *J Proteomics* **72**: 210-218
- Biggs JS, Olivera BM, Kantor YI (2008) Alpha-conopeptides specifically expressed in the salivary gland of *Conus pulicarius*. *Toxicon* **52**: 101-105
- Dutertre S, Biass D, Stöcklin R, Favreau P (2010) Dramatic intraspecimen variations within the injected venom of *Conus consors*: an unsuspected contribution to venom diversity. *Toxicon* **55**: 1453-1462
- Halai R, Craik DJ (2009) Conotoxins: natural product drug leads. *Nat Prod Rep* **26**: 526-536
- Le Gall F., Favreau P, Benoit E, Mattei C, Bouet F, Menou JL, Ménez A, Letourneux Y, Molgó J (1999) A new conotoxin isolated from *Conus consors* venom acting selectively on axons and motor nerve terminals through a Na<sup>+</sup>-dependent mechanism. *Eur J Neurosci* **11**: 3134-3142
- Olivera BM, Cruz LJ (2001) Conotoxins, in retrospect. *Toxicon* **39**: 7-14

## ***Immunomodulatory effects of Androctonus australis hector scorpion venom on macrophage activation***

Djelila HAMMOUDI-TRIKI, Hajer SAIDI, Fouzia GUESTINI, Lamia ALOUACHE, Amina MENDIL, Sassia SAMI-MERAH, Sonia ADI-BESSALEM, Fatima LARABA-DJEBARI\*

Laboratoire de Biologie Cellulaire et Moléculaire, Faculté des Sciences Biologiques, Université des Sciences et de la Technologie « Houari Boumédiène » (USTHB), El Alia BP 32, 16111 Bab Ezzouar, Alger, Algérie ; Laboratoire de Recherche et de Développement sur les Venins, Institut Pasteur d'Algérie, Alger, Algérie

\* Corresponding author ; Tel : +213 21917427 ; Fax : +213 21917221 ; E-mail : [flaraba@hotmail.com](mailto:flaraba@hotmail.com)

---

### **Abstract**

*The aim of this study is to investigate the immunomodulatory effects of Androctonus australis hector (Aah) venom on macrophagic activity. The peritoneal macrophages were harvested and cultured with or without Aah venom according to different kinetic times. The obtained results indicate an increase of the cytotoxic and metabolic activities of macrophages induced by Aah venom. In vitro studies revealed a significant time dependant release of pro-inflammatory cytokines (IL-1 $\beta$ , TNF $\alpha$ , IL-6) and anti-inflammatory cytokine (IL-10). An increase in H<sub>2</sub>O<sub>2</sub> and acid phosphatase production in macrophages cultured in the presence of Aah venom is observed. Significant differences were also detected in the time-course of cytokine levels. In addition to oxygen dependant mechanisms, macrophages used metabolic mechanisms which lead to the presence of acid phosphatase levels.*

### **Effets immunomodulateurs du venin du scorpion Androctonus australis hector sur l'activation des macrophages**

*L'objectif de cette étude est d'évaluer les effets immunomodulateurs du venin d'Androctonus australis hector (Aah) sur les activités des macrophages murins. Les macrophages péritonéaux résidents sont isolés et mis en culture en absence ou en présence du venin d'Aah. Les résultats obtenus montrent que le venin augmente l'activité cytotoxique des macrophages. L'étude menée révèle une production significative, dépendante du temps, des cytokines pro-inflammatoires (IL-1 $\beta$ , IL-6, TNF $\alpha$ ) et anti-inflammatoire (IL-10). Le venin d'Aah induit également un métabolisme oxydatif (péroxyde d'hydrogène) et non-oxydatif (phosphatase acide) des macrophages. En effet, les macrophages libèrent une concentration élevée de H<sub>2</sub>O<sub>2</sub> et induisent une activité importante de la phosphatase acide.*

**Keywords :** Acid phosphatase, cytokines, H<sub>2</sub>O<sub>2</sub>, macrophage, scorpion venom.

---

## **Introduction**

Macrophage cells play a dual role in the inflammatory process. They can initiate innate immune responses but they can also be effector cells, which contribute to the resolution of these responses. Scorpion venom could be a model of understanding this complex immune response. The inflammatory response is essential for structural and functional repair of injured tissue observed in scorpion pathology (Petricevich, 2010). Macrophages damaged tissues during inflammation by two separate oxidative pathways involving the synthesis of superoxide anion and the production of a variety of cytokines, active substances and prostaglandins (Beutler, 2004). The increment of the levels of pro- and anti-inflammatory cytokines leads to activation of macrophages, neutrophils, NK cells, T cells, and B cells.

## **Immunomodulating effect of Aah scorpion venom**

To evaluate immunomodulating activity of Aah venom, peritoneal macrophages were exposed to different concentrations of venom in RPMI-1640 containing 10% FCS. After incubation at 37°C for various intervals of time in a humidified atmosphere of 5% CO<sub>2</sub>, activation of the cultured peritoneal macrophages was determined by measuring the cytokine production and oxygen intermediate metabolites (H<sub>2</sub>O<sub>2</sub>). *In vitro* studies revealed that the venom induced activation of macrophage cells with an increment in cytokines levels, H<sub>2</sub>O<sub>2</sub> and phosphates acid (data not shown). The obtained results revealed cytotoxic effect of Aah venom 24 h after dose-dependent incubation (Figure 1). This venom induced a significant toxic activity of peritoneal macrophage (70%) with 25  $\mu$ g/ml of venom when compared to the control. The larger concentrations of venom present higher action than its lower concentrations. It seems that Aah venom probably inhibits functional and metabolic activities of macrophage or leads to a particular activation stage of these cells that exhibit inflammatory properties.

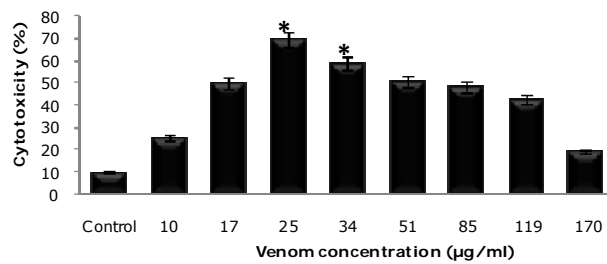
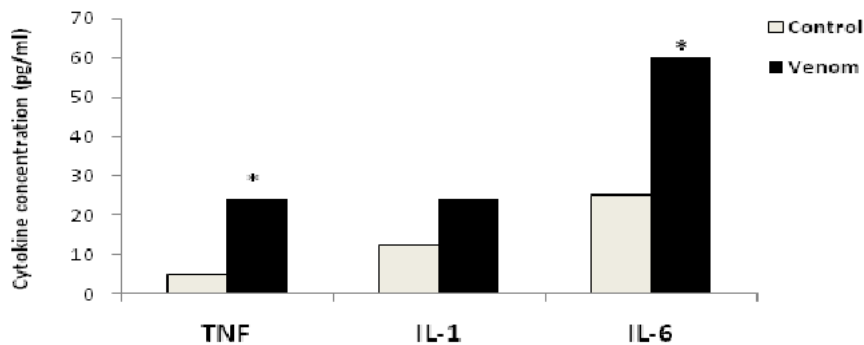

**Figure 1.** Effect of venom concentration on macrophage cytotoxic activity. Peritoneal adherent macrophages were incubated for 24 h in RPMI-1640 medium containing various concentrations of *Aah* venom. Macrophages were isolated from BALB/c mice ( $1 \times 10^6$  cells/mL), and cultured in 96-well flat-bottomed microtiter. Each value represents the mean  $\pm$  S.D. ( $n = 3$ ). \* $P \leq 0.05$  vs control.

**Figure 1.** Effet des concentrations de venin sur l'activité cytotoxique des macrophages. Les macrophages péritonéaux ( $10^6$  cellules/mL) sont mis en culture dans le milieu RPMI pendant 24 h avec des concentrations croissantes de venin d'*Aah*. Chaque valeur représente la moyenne  $\pm$  D.S. ( $n=3$ ). \*  $P \leq 0.05$  par comparaison aux témoins.

### Effects of *Aah* venom on cytokine levels

Macrophages are the major source of TNF $\alpha$ , IL-1, IL-6, IL-10 and superoxide anion, and participate as major effector cells in resistance against infectious agents and tumor cells. Macrophages are activated to become cytotoxic by a set of cytokine signals. Therefore, in the present study, we examined whether *Aah* venom activated macrophages to induce effector molecules such as cytokines, H<sub>2</sub>O<sub>2</sub> and phosphates acid. *Aah* venom was shown to stimulate macrophage production of IL-1, IL-6, TNF $\alpha$  and IL-10, 24 h after macrophage stimulation (Figure 2). The level of cytokines induced by *Aah* venom were higher ( $P \leq 0.05$ ) than that of the control. IL-6 is also considered as a major immune and inflammatory mediator. The above three cytokines are related to each other in that they are coordinately released from activated macrophages, and IL-1 can induce IL-6. However, IL-6 does not induce IL-1 but rather suppresses its production by macrophages. TNF $\alpha$  exerts wide biological activities and contributes to the pathophysiology of septic shock. These results are in accordance with previous studies that showed a pro-inflammatory cytokines release from mice macrophages exposed to different venoms (Lomonte *et al.*, 1999; Petricevich, 2002; Adi-Bessalem *et al.*, 2008).



**Figure 2.** Effects of *Aah* venom on cytokine release from macrophages. Culture media were analyzed for cytokine production by an ELISA kit. Each value represents the mean  $\pm$  S.D. ( $n = 3$ ). \* $P \leq 0.05$  vs control.

**Figure 2.** Effets du venin d'*Aah* sur la production des cytokines par les macrophages. La quantification des cytokines est réalisée dans les surnageants de culture cellulaire par des Kit ELISA. Chaque valeur représente la moyenne  $\pm$  D.S. ( $n=3$ ). \*  $P \leq 0.05$  par comparaison aux témoins.

### Conclusion

In the present study, we provide evidence suggesting that *Aah* venom presents a potent immunomodulatory property and can enhance macrophage function. The understanding of molecular mechanisms of macrophages activation caused by the venom as well as the characterization of the responsible substances in the venom for the observed effects has yet to be determined.

### References

- Adi-Bessalem S, Hammoudi-Triki D, Laraba-Djebari F (2008) Pathophysiological effects of *Androctonus australis* hector venom. *Exp Toxicol Pathol* **60**: 373-380
- Beutler B (2004) Innate immunity: an overview. *Mol Immunol* **40**: 845-859
- Lomonte B, Tarkowski A, Hanson LA (1993) Host response to *Bothrops asper* snake venom. Analysis of edema formation, inflammatory cells, and cytokine release in a mouse model. *Inflammation* **17**: 93-105
- Petricevich VL (2002) Effect of *Tityus serrulatus* venom on cytokine production and the activity of murine macrophages. *Mediators Inflamm* **11**: 23-31
- Petricevich VL (2010) Scorpion venom and the inflammatory response. *Mediators Inflamm* doi: 10.1155/2010/903295

## **Local inflammatory response induced by *Androctonus australis hector* venom and its toxic fraction Ftox-G50**

Rym BOUKARI, Sassia SAMI-MERAH, Fatima LARABA-DJEBARI\*

Laboratoire de Biologie Cellulaire et Moléculaire, Faculté des Sciences Biologiques, Université des Sciences et de la Technologie « Houari Boumédiène » (USTHB), El Alia BP 32, 16111 Bab Ezzouar, Alger, Algérie ;  
Laboratoire de Recherche et de Développement sur les Venins, Institut Pasteur d'Algérie, Alger, Algérie

\* Corresponding author ; Tel : +213 21917427 ; Fax : +213 21917221 ; E-mail : [flaraba@hotmail.com](mailto:flaraba@hotmail.com)

---

### **Abstract**

The use of the rat air pouch model of inflammation indicates that *Androctonus australis hector* venom and its toxic fraction (FTox-G50) induce a local acute inflammatory response characterized by an increase in microvascular permeability which could facilitate the delivery of protein and neutrophil accumulation in the site of inflammation. This effect could be promoted by an increase in inflammatory mediator release such as tumor necrosis factor (TNF- $\alpha$ ), prostanoïds and nitric oxide.

### **Réponse inflammatoire locale provoquée par le venin d'*Androctonus australis hector* et ses toxines**

L'utilisation du modèle expérimental de la réaction inflammatoire de la poche d'air indique que le venin d'*Androctonus australis hector* et sa fraction toxique (Ftox-G50) provoquent une réponse inflammatoire aigüe locale, caractérisée par une augmentation de la perméabilité vasculaire qui pourrait faciliter l'extravasation des protéines et l'accumulation des neutrophiles au niveau du site inflammatoire. Cet effet pourrait être favorisé par une augmentation de la libération de médiateurs inflammatoires tels que le facteur de nécrose tumorale (TNF- $\alpha$ ), les prostanoïdes et le monoxyde d'azote (NO).

**Keywords :** Aah venom, air pouch, F(ab')<sub>2</sub> fragments, inflammation, inflammatory inhibitors, toxic fraction.

---

## **Introduction**

Scorpion venoms cause systemic effects characterized by an inflammatory reaction revealed by an accumulation of leukocytes and a release of endogenous mediators (Magalhaes *et al.*, 1999; Coelho *et al.*, 2007). In previous studies, we have found that the injection of *Aah* venom and its toxins were able to induce a systemic and local inflammatory reaction, which is revealed by high serum levels of IL-1, IL-6 and TNF- $\alpha$  and leucocyte infiltration in lung, heart tissues and peritoneal cavity (Adi-Bessalem *et al.*, 2008; Sami-Merah *et al.*, 2008). The observed edema in lung tissue and inflammatory cell accumulation seem to be related to the eicosanoid production (Sami-Merah *et al.*, 2009). The present study was undertaken to investigate the direct effects of *Aah* venom on protein leakage and leucocyte accumulation, as well as the involved inflammatory mediators.

## **Methods**

In this study, we used the rat air pouch assay, an *in vivo* model used to study local acute inflammation. This model is performed by a subcutaneous injection of sterile air of the back of rat. We injected into this air pouch a sublethal dose of *Aah* venom (0.5 mg/kg) or its whole toxic fraction: Ftox-G50 (0.4 mg/kg). The Ftox-G50 was isolated from the crude venom by gel filtration through Sephadex G50 as previously described by Laraba-Djebari and Hammoudi-Triki (Laraba-Djebari and Hammoudi-Triki., 1998). The animal controls received the same volume of saline solution. Some groups of animals received by i.p. route, antibodies constituted by F(ab')<sub>2</sub> anti-FTox-G50 (40 mg/kg), pentoxifylline (45 mg/kg), an inhibitor of synthesis of tumor necrosis factor (TNF) or dexamethasone (5 mg/kg), an inhibitor of prostanoid formation 30 min before envenomation. Animals were anaesthetized at different times after envenomation with or without pretreatment and the pouches were washed with 2 mL of saline solution. The washed fluids were used in the different test.

Activation of local inflammatory response was explored by assessment of (i) protein leakage, (ii) myeloperoxidase activity (MPO) as an index of polymorphonuclear neutrophil recruitment and (iii) NO release, in the obtained exudates from the air pouch at 3 and 24 h post envenomation.

## **Results**

The protein content of obtained exudates from the air pouch increased significantly after local administration of

*Aah* venom and its toxic fraction at 3 and 24h post envenomation when compared with the control (Figure 1A).

*Aah* venom and Ftox-G50 injected into the air pouch affected also MPO activity and NO release. High levels of MPO and NO in the air pouch exudates were obtained at 3 and 24 h after envenomation when compared to the control group (Figure 1B and C). Increase in MPO activity indicates a local marked neutrophil accumulation compared to the animal controls. The most important effects were obtained with the FTox-G50.

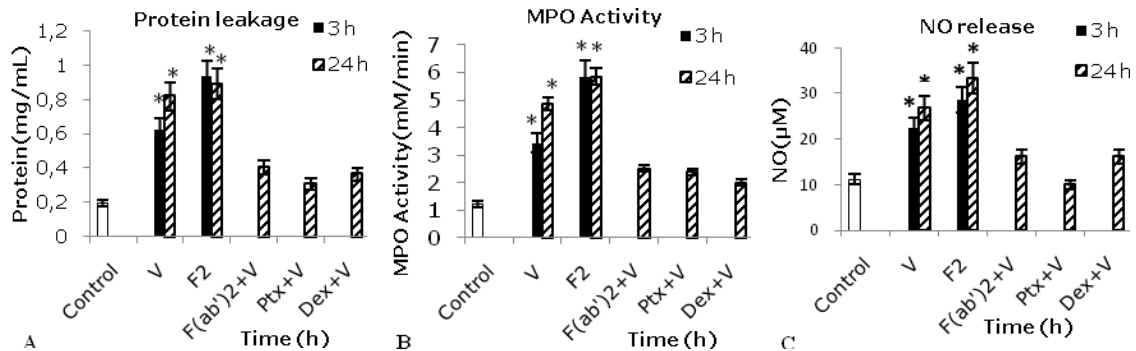

**Figure 1.** Effect of *Aah* venom or its toxic fraction Ftox-G50 on (A) the protein leakage, (B) MPO activity and (C) NO release in the air pouch exudates. Results are expressed as mean  $\pm$  SD. \*P < 0.05 when compared with animal controls. V: venom, F2: Ftox-G50, Ptx: pentoxifylline, Dex: dexamethasone.

**Figure 1.** Effet du venin *Aah* ou de sa fraction toxique Ftox-G50 sur l'extravasation des protéines, l'activité MPO et la libération du NO au niveau des exsudats dans la poche d'air. Les résultats sont exprimés par la moyenne  $\pm$  SD. \*P < 0.05 par comparaison avec le contrôle. V: venin, F2: Ftox-G50, Ptx: pentoxifylline, Dex: dexaméthasone.

The effects of different treatments on the local inflammatory response were evidenced by the administration of antibodies as anti-Ftox-G50 F(ab')<sub>2</sub> fragments, and the inflammatory inhibitors, dexamethasone or pentoxifylline, reduced significantly the local inflammatory response induced by the venom. A decrease of protein leakage, MPO level and NO release in air pouch exudates, were observed (Figure 1).

## Conclusion

The increase in microvascular permeability is hallmark of inflammatory process; which facilitates the delivery of proteins and cells from the vascular space to the extravascular compartment. NO plays a key role in the regulation of microvascular permeability in acute inflammation (Di Lorenzo *et al.*, 2009). This study indicates that *Aah* venom is able to induce local inflammatory reaction characterized by a marked neutrophil infiltration, protein extravasation subsequent to the increase in vascular permeability. This could be promoted by inflammatory mediators such as TNF- $\alpha$ , prostanoids and NO, into local area. The local pretreatment with antibodies raised against the major toxic fraction of the venom (Ftox-G50) reduces the observed inflammatory effects, suggesting they could be due to the neurotoxic components of the venom. The recruitment of neutrophils, protein extravasation and NO production were reduced after use of dexamethasone and pentoxifylline respectively inhibitors of prostanoids and TNF- $\alpha$  effects.

## References

- Adi-Bessalem S, Hammoudi-Triki D, Laraba-Djebari F (2008) Pathophysiological effects of *Androctonus australis hector* scorpion venom: Tissue damages and inflammatory response. *Exp Toxicol Pathol* **60**: 373-380
- Coelho MF, Pessini AC, Coelho AM, Pinho VS, Souza DG, Arantes EC, Teixeira MM, Teixeira A (2007) Platelet activating factor receptors drive CXC chemokine production, neutrophil influx and edema formation in the lungs of mice injected with *Tityus serrulatus* venom. *Toxicon* **50**: 420-427
- Di Lorenzo A, Fernández-Hernando C, Cirino G, Sessa WC (2009) Akt1 is critical for acute inflammation and histamine-mediated vascular leakage. *Proc Natl Acad Sci USA* **106**: 14552-14557
- Magalhaes MM, Pereira ME, Amral CF, Rezend NA, Campolina D, Bucarety F, Gazzinelli RT, Cunha-Melo JR (1999) Serum levels of cytokines in patients envenomed by *Tityus serrulatus* scorpion sting. *Toxicon* **37**: 1155-1164
- Laraba-Djebari F, Hammoudi-Triki D (1998) Utilisation de la fraction toxique majoritaire isolée à partir du venin *Androctonus australis hector* dans la valorisation du sérum anti scorpionique. *Arch Inst Pasteur d'Algérie* **62**: 254-266
- Sami-Merah S, Hammoudi-Triki D, Martin-Eauclaire MF, Laraba-Djebari F (2007) La toxine *Aah* II d'*Androctonus australis hector*: effets inflammatoire et histopathologique. In *Toxines émergentes: nouveaux risques*, Collection Rencontres en Toxinologie. Goudey-Perrière F, Benoit E, Marchot P, Popoff MR (eds) pp 203-204. Cachan: Librairie Lavoisier
- Sami-Merah S, Hammoudi-Triki D, Martin-Eauclaire MF, Laraba-Djebari F (2008) Combination of two antibody fragments F(ab')<sub>2</sub>/Fab: An alternative for scorpion envenoming treatment. *Intern Immuno Pharmacol* **8**: 1386-1394
- Sami-Merah S, Hammoudi-Triki D, Adi-bessalem S, Mendil A, Martin-Eauclaire MF, Laraba-Djebari F (2009) L'augmentation de la perméabilité vasculaire serait-elle un facteur déclenchant de l'œdème pulmonaire induit par le venin du scorpion *Androctonus australis hector*? In *Toxines et signalisation*. Benoit E, Goudey-Perrière F, Marchot P et Servent D (eds) pp 161-163. Publications de la SFET, Châtenay-Malabry, France, Epub on <http://www.sfet.asso.fr> (ISSN 1760-6004)

## **Pharmacological assessment of inflammatory mediators after *Androctonus australis hector* envenomation : involvement of histamine H1 receptor**

Sonia ADI-BESSALEM, Sassia SAMI-MERAH, Amina MENDIL, Djelila HAMMOUDI-TRIKI, Fatima LARABA-DJEBARI\*

Laboratoire de Biologie Cellulaire et Moléculaire, Faculté des Sciences Biologiques, Université des Sciences et de la Technologie « Houari Boumédiène » (USTHB), El Alia BP 32, 16111 Bab Ezzouar, Alger, Algérie ; Laboratoire de Recherche et de Développement sur les Venins, Institut Pasteur d'Algérie, Alger, Algérie

\* Corresponding author ; Tel : +213 21917427 ; Fax : +213 21917221 ; E-mail : flaraba@hotmail.com

---

### **Abstract**

The promethazine pretreatment reduces the vascular permeability and infiltration of polymorphonuclear cells in lungs induced by *Androctonus australis hector* (Aah) venom in mice, which suggests participation of histaminergic receptors. The decrease of accumulation fluid assessed as wet-to-dry lung weight ratio and the inhibition of the cellular peroxidase activities (EPO and MPO) in lungs confirm these results. The tested H1 antagonists showed also a marked anti-inflammatory effect on eosinophil and neutrophil recruitment in the pulmonary parenchyma.

### **Implication des récepteurs histamine H1 dans la réponse inflammatoire après une envenimation scorpionique expérimentale**

Les souris ont été prétraitées 30 minutes avant leur envenimation par le venin d'*Androctonus australis hector* (Aah) par la prométhazine, un antagoniste histaminique (H1). 24 heures après l'envenimation, ce traitement a induit une réduction de l'œdème pulmonaire et de la perméabilité vasculaire en comparaison avec les animaux envenimés et non traités. Les valeurs des activités peroxydases (EPO et MPO) semblent se rapprocher de celles du témoin.

**Keywords :** Histamine, histamine H1 receptor, inflammation, lung edema, scorpion venom.

---

## **Introduction**

Histamine is a well studied endogenous molecule as an autacoid and neurotransmitter with multiple physiological and pathological effects in different organ systems (Hill *et al.*, 1997). Histamine is stored in mast cells and basophils. The pharmacological interaction of histamine with the H1, H2, H3 and H4 cell surface receptors (H1R–H4R) promotes change in vascular permeability, levels of cyclic nucleotides, neutrophil and eosinophil chemotaxy, gastrointestinal secretion and smooth muscle contraction (Marquardt, 1983; Hill *et al.*, 1997). The H1R and H4R play an important role in inflammatory responses. In the lungs, H1Rs mediate functions such as bronchoconstriction, vasoconstriction and edema formation (Parsons and Ganellin, 2006).

Several studies on scorpion envenomation have shown the involvement of vasoactive substances such as histamine, platelet activation factor, leukotrienes, prostaglandins in the biological changes and tissue damage (Freire-Maia and De Matos, 1993; Nascimento *et al.*, 2005; Coelho *et al.*, 2007; Pessini *et al.*, 2008). In the most severe cases of envenomation, the clinical findings are congestive heart failure, pulmonary edema, respiratory failure and cardiac arrest. These cardio-respiratory disturbances are attributed to different pathways of activation and to interaction between inflammatory cells and humoral factors (De Matos *et al.*, 2001; Coelho *et al.*, 2007).

The aim of this study is based on the assessment of the involvement of histamine H1 receptors in the onset of pulmonary manifestations during a scorpion envenomation.

## **Methods**

To explore implication of some inflammatory mediators in the genesis of pulmonary edema after envenomation by *Androctonus australis hector* (Aah) venom [0.5 mg/kg; subcutaneous (s.c.) route], promethazine, a selective H1 receptor inhibitor (5 mg/kg), was administrated 30 min prior envenomation into 4 mice. Lung injury was assessed by (i) measuring vascular permeability *via* Evans blue dye, (ii) determining lung-to-body weight ratio (pulmonary index) and (iii) histological analysis. The activities of myeloperoxidase (MPO) and eosinophil peroxidase (EPO) (markers of tissue neutrophil and eosinophil accumulation, respectively) were

measured spectrophotometrically using the peroxidase substrate tetramethylbenzidine and ophenylenediamine, respectively. Results are expressed as units (U) per 100 mg tissue.

## Results

*Aah* venom induced leukocytosis (Adi-Bessalem *et al.*, 2008), increase in vascular permeability, accumulation of fluid in the lungs and severe lung edema (Figure 1A and Figure 2). The obtained results showed also that *Aah* venom induces rapid infiltration of polynuclear cells in lungs that was confirmed by increased levels of myeloperoxidase and eosinophil peroxidase activities (Figure 1B and Figure 2). Compared to control animals, high seric concentration of histamine was also evidenced after envenomation (from  $3 \pm 0.5$  to  $19 \pm 0.98$  ng/ml). Plasma extravasation and edema-forming in response to *Aah* venom suggested the involvement of vasoactive mediators such as histamine derived probably from mast cell granules.

Administration of promethazine induces a significant decrease of lung edema induced by *Aah* venom when compared to no treated mice. As shown in Figure 1A, the vascular permeability and pulmonary index are significantly reduced. The MPO and EPO activities decreased from  $0.313 \pm 0.061$  to  $0.191 \pm 0.06$  U/100 mg tissue and from  $0.65 \pm 0.034$  to  $0.304 \pm 0.039$  U/100 mg tissue, respectively. Histological analysis confirmed the inhibition of edema forming and inflammatory cell recruitment in pulmonary parenchyma compared to envenomed mice (Figure 2).

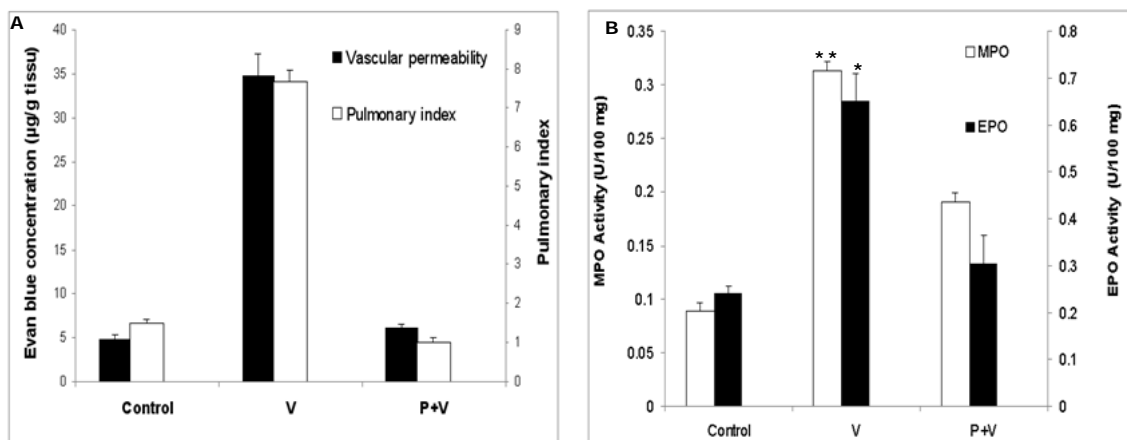

**Figure 1.** Assessment of pulmonary edema (A) and recruitment of neutrophil and eosinophils in lungs by measuring MPO and EPO activities (B) after envenomation (V, 0.5 mg/kg, s.c.) with and without promethazine (P, 5 mg/kg), the H1 receptor antagonist (n=4, \* p<0.05, \*\* p<0.01).

**Figure 1.** Effet de la prométhazine (P, 5 mg/kg) administrée 30 min avant le venin (V, 0,5 mg/kg) sur (A) l'œdème pulmonaire et (B) la valeur des activités myéloperoxydase (MPO) et peroxydase éosinophile (EPO; n=4, \* p<0,05, \*\* p<0,01).

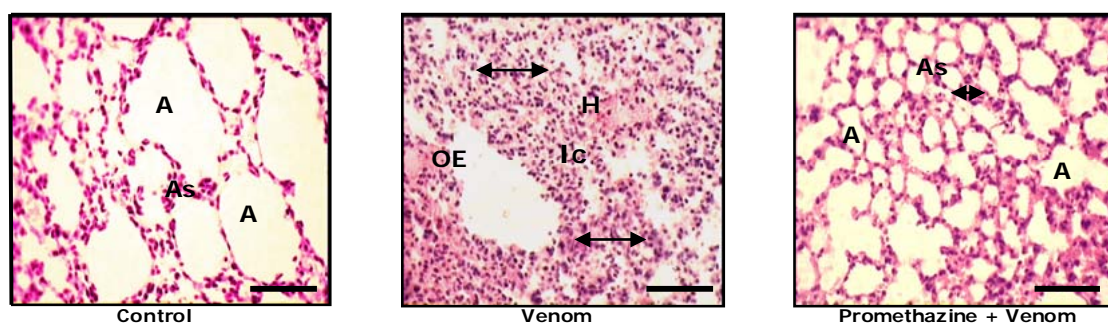

**Figure 2.** Lung light micrographs from pretreated mice 24 h after scorpion venom injection (0.5 mg/kg, s.c.) with promethazine. Staining: haematoxylin and eosin. Bar: 33 µm. Alveolar (A), Alveolar septa (As), Pulmonary edema (OE), hemorrhage (H), inflammatory cell infiltrates (Ic). The arrows indicate the alveolar septa thickening.

**Figure 2.** Micrographies des poumons de souris prétraitées avec la prométhazine, 24 h après envenimation (0,5 mg/kg, s.c.). Coloration: Hématoxyline et éosine. Barre: 33 µm. Les flèches indiquent l'épaississement des parois inter-alvéolaires.

## Conclusion

It seems that the recruitment of inflammatory cells (neutrophils and eosinophils) in lungs was significantly reduced after inhibition of the histamine effects on vascular permeability and leukocyte chemotaxis. The H1 receptor antagonist inhibits the action of histamine on tissues containing H1 receptors and prevents the access of histamine to its receptors by competitive antagonism. H1R stimulation leads to generation of arachidonic acid by PLA2 enzymatic action leading to the production of powerful vasoactive mediator like prostacycline and

thromboxane A2. The involvement of prostaglandins and leukotrienes in *Aah* venom-induced edema has already confirmed by treatment of animals with the corticosteroid dexamethasone, which markedly reduced vascular permeability (Sami-Merah et al., 2009).

It would be interesting to well characterized function of histamine H1 receptors and the others receptor such as H2-H4R in modulation of inflammatory response after scorpion envenomation.

## References

- Adi-Bessalem S, Hammoudi-Triki D, Laraba-Djebari F (2008) Pathophysiological effects of *Androctonus australis hector* scorpion venom: Tissue damages and inflammatory response. *Exp Toxicol Pathol* **60**: 373-380
- Coelho F, Pessini AC, Coelho AM, Pinho VS, Souza DG, Arantes EC, Teixeira MM, Teixeira AL (2007) Platelet activating factor receptors drive CXC chemokine production, neutrophil influx and edema formation in the lungs of mice injected with *Tityus serrulatus* venom. *Toxicon* **50**: 420-427
- De-Matos IM, Talvani A, Rocha OO, Freire-Maia L, Teixeira MM (2001) Evidence for a role of mast cells in the lung edema induced by *Tityus serrulatus* venom in rats. *Toxicon* **39**: 863-867
- D'Suze G, Salazar V, Díaz P, Sevcik C, Azpurua H, Bracho N. (2004). Histopathological changes and inflammatory response induced by *Tityus discrepans* scorpion venom in rams. *Toxicon* **44**: 851-860
- Freire-Maia L, De Matos IM (1993) Heparin or a PAF antagonist (BN-52021) prevents the acute pulmonary edema induced by *Tityus serrulatus* scorpion venom in the rat. *Toxicon* **31**: 1207-1210
- Hill SJ, Ganellin CR, Timmerman H, Schwartz JC, Shankley NP, Young JM, Schunack W, Levi R, Haas HL (1997) International Union of Pharmacology. XIII. Classification of histamine receptors. *Pharmacol Rev* **49**: 253-278
- Marquardt DL (1983) Histamine. *Clin Rev Allergy* **1**: 343-351
- Nascimento EB Jr, Costa KA, Bertollo CM, Oliveira ACP, Rocha LTS, Souza ALS, Glória MBA, Moraes-Santos T, Coelho MM (2005) Pharmacological investigation of the nociceptive response and edema induced by venom of the scorpion *Tityus serrulatus*. *Toxicon* **45**: 585-593
- Parsons ME, Ganellin CR (2006) Histamine and its receptors. *Br J Pharmacol* **147**: 127-135
- Pessini AC, Kanashiro A, Malvar DDC, Machado RR, Soares DM, Figueiredo MJ, Kalapothakis E, Souza GEP (2008) Inflammatory mediators involved in the nociceptive and oedematogenic responses induced by *Tityus serrulatus* scorpion venom injected into rat paws. *Toxicon* **52**: 729-736
- Sami-Merah S, Hammoudi-Triki D, Adi-bessalem S, Mendil A, Martin-Eauclaire MF, Laraba-Djebari F (2009) L'augmentation de la perméabilité vasculaire serait-elle un facteur déclenchant de l'oedème pulmonaire induit par le venin du scorpion *Androctonus australis hector*? In *Toxines et signalisation*. Benoit E, Goudey-Perrière F, Marchot P et Servent D (eds) pp 161-163. Publications de la SFET, Châtenay-Malabry, France, Epub on <http://www.sfet.asso.fr> (ISSN 1760-6004)
-







## Avancées et nouvelles technologies en Toxinologie

Ce troisième volume de la nouvelle série de livres électroniques directement édités par la SFET, après sept ouvrages imprimés et distribués par Elsevier puis la Librairie Lavoisier depuis 2001, rassemble trente-et-un chapitres organisés en quatre sections illustrant, respectivement, des approches de « Génomique, transcriptomique et protéomique » (cinq chapitres), « Détection et neutralisation » (onze chapitres), « Structure et interaction » (six chapitres) et « Toxines bactériennes et diverses » (neuf chapitres). Le libre accès des livres électroniques par Internet ainsi que le nombre croissant de chapitres en anglais (vingt-cinq en 2010, contre quinze en 2009 et huit en 2008) témoignent de la volonté de la SFET de s'ouvrir largement à la communauté scientifique internationale attachée à la recherche en Toxinologie. La majorité de ces chapitres illustre parfaitement le thème retenu par le Conseil Scientifique de la SFET pour les 18<sup>èmes</sup> Rencontres en Toxinologie (RT18, 2010), lesquelles auront rassemblé conférenciers réputés et jeunes chercheurs, conformément aux objectifs de la SFET, et se seront comme en 2009 déroulées sur le site prestigieux de l'Institut Pasteur au cœur de Paris. Ce thème, également titre du présent ouvrage, témoigne de l'évolution permanente et de la transversalité d'une discipline scientifique toujours d'actualité et d'avenir, et du désir de l'ensemble des membres de la SFET de continuer à développer et promouvoir la recherche en Toxinologie.

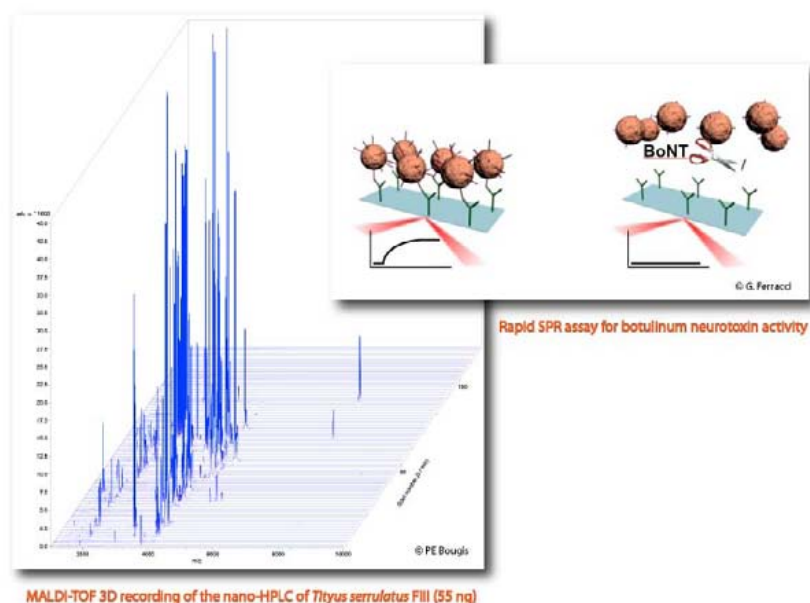

## Advances and new technologies in Toxinology

*This third issue of the new series of e-books directly edited by the SFET, after seven books printed and distributed by publishers Elsevier then Librairie Lavoisier since 2001. It gathers thirty-one chapters organized in four sections offering alternative approaches to the study of Toxinology and entitled « Genomic, transcriptomic and proteomic » (five chapters), « Detection and neutralisation » (eleven chapters), « Structure and interaction » (six chapters), and « Bacterial toxins and miscellaneous » (nine chapters), respectively. The increasing number of chapters in English (twenty-five in 2010, for fifteen in 2009 and eight in 2008) warrants the SFET willing to open to the international scientific community devoted to the research in Toxinology. A majority of these chapters closely reflect the theme retained by the Scientific Board of the SFET for the 18<sup>th</sup> Meeting on Toxinology (RT18, 2010), which will gather well-known speakers and young researchers, accordingly to the SFET objectives and, as in 2009, will be held at the prestigious Pasteur Institute in the heart of Paris. The focus of the meeting, also the title of this e-book, show the evolution and versatility of a scientific discipline that is always up to date, as well as the willingness of the SFET members to keep developing and promoting research in Toxinology.*

Pascale Marchot,  
Centre National de la Recherche Scientifique – Université d'Aix-Marseille