



HAL
open science

Guidance of Unmanned Surface Vehicles: Experiments in Vehicle Following

Marco Bibuli, Massimo Caccia, Lionel Lapierre, Bruzzone Gabriele

► **To cite this version:**

Marco Bibuli, Massimo Caccia, Lionel Lapierre, Bruzzone Gabriele. Guidance of Unmanned Surface Vehicles: Experiments in Vehicle Following. IEEE Robotics and Automation Magazine, 2012, 19 (3), pp.92-102. 10.1109/MRA.2011.2181784 . hal-00733773

HAL Id: hal-00733773

<https://hal.science/hal-00733773v1>

Submitted on 19 Sep 2012

HAL is a multi-disciplinary open access archive for the deposit and dissemination of scientific research documents, whether they are published or not. The documents may come from teaching and research institutions in France or abroad, or from public or private research centers.

L'archive ouverte pluridisciplinaire **HAL**, est destinée au dépôt et à la diffusion de documents scientifiques de niveau recherche, publiés ou non, émanant des établissements d'enseignement et de recherche français ou étrangers, des laboratoires publics ou privés.

Control of Unmanned Surface Vehicles

Experiments in Vehicle Following

By Marco Bibuli, Massimo Caccia, Lionel Lapierre, and Gabriele Bruzzone

Virtual target-based path-following techniques are extended to execute the task of vehicle following in the case of unmanned surface vehicles (USVs). Indeed, vehicle following is reduced to the problem of tracking a virtual target moving at a desired range from a master vessel, while separating the spatial and temporal constraints, giving priority to the former one. The proposed approach is validated experimentally in a harbor area with the help of the prototype USVs ALANIS and Charlie, developed by Consiglio Nazionale delle Ricerche-Istituto di Studi sui Sistemi Intelligenti per l'Automazione (CNR-ISSIA) **<AU: Please check whether the expanded form of "CNR-ISSIA" is correct.>**

Digital Object Identifier 10.1109/MRA.2011.942995
Date of publication:

The 21st century's scenarios of marine operations, regarding environmental monitoring, border surveillance, warfare, and defense applications, foresee the cooperation of networked heterogeneous manned/unmanned air, ground, and marine platforms. Examples are given by the autonomous ocean sampling network, integrating robotic vehicle and ocean models to increase the capacity of observing and predicting the ocean behavior and the Barents 2020 vision, optimizing marine resources; thanks to historical and real-time information collected by a large network of cooperating vehicles.

In this framework, USVs, given their position at the air-sea interface, can play a key role both in relaying radio-frequency transmissions in air and acoustic transmissions undersea, as proposed, for instance, in the European Commission (EC)-funded **<AU: Please check**

whether the spell out form of EC is correct.> ASIMOV project [1], and monitoring ocean and atmosphere dynamics as well as surface and underwater intrusions. As a consequence of their networking capabilities, USVs are naturally seen as a part of flotillas of heterogeneous vehicles executing large-scale surveys and supporting rapid environmental assessment (REA). The result is that an increasing number of prototype vehicles have been developed for science, bathymetric mapping, defense, and general robotics research. For an overview of the developed prototype vessels and basic design and research trends and issues, the reader can refer to [2].

In this context, the research presented in the following deals with aspects related to cooperative motion control of unmanned marine vehicles (UMVs), focusing on the theoretical and experimental study of the problem of a slave USV following a master vessel at a predefined range. This simple formation configuration, with its natural extension to a fleet of slaves vehicles following a master vessel, is the base for a number of different applications. An example is given by the execution of morphobathymetric surveys in very shallow water, such as coastal lagoons, combining the use of vertical incidence echosounders and subbottom chirp devices [3]. In this case, a flotilla of USVs can constitute a force multiplier in executing multiple surveys with the same sensor, installed aboard the master and slave vessels, respectively, or using different sensors in the same place at the same time with respect to the spatiotemporal resolution of the phenomena under investigation, as in the case of acoustic devices that cannot work when mounted below the same hull. A team of heterogeneous USVs able to tackle this problem is currently under development at the National Research Council of Italy. Other interesting operational scenarios include surveys, i.e., periodic bathymetries for evaluating the distribution of sediments and classifying their quality, of harbor areas for driving dredging, coastal landslides and sand distribution for beach maintenance, and artificial lakes, including dam inspection.

The main contribution of this article relies in the experimental validation of guidance techniques, i.e., virtual target-based path following and their extension to handle multivehicle cooperation as well as in identifying the major sources of performance limitations. Successful experimental demonstrations, contributing to bridge the gap between theory and practice, push the development of operational marine robots for marine monitoring, surveillance, exploration, and exploitation.

In particular, experiments have been carried out in a harbor area using the Charlie USV [4] as a slave vehicle and the dual-mode ALANIS vessel [5], in this case piloted by a human operator, as a master vehicle. As discussed in the following, the proposed guidance law privileges the spatial constraint of driving the slave vehicle over the reference path with respect to the temporal requirement of maintaining a desired range from the master vessel. The target path, defined by the motion of the master vessel, is

followed by adopting a conventional nonlinear path-following algorithm of the type discussed in [6].

Problem Definition and State-of-the-Art

In the literature, motion control scenarios of USVs are usually classified into three main categories (point stabilization, trajectory tracking, and path following), along with the concept of path maneuvering (see, for instance, [7]).

- *Point stabilization*: The goal is to stabilize the vehicle zeroing the position and orientation error with respect to a given target point with a desired orientation (in the absence of currents). The goal cannot be achieved with smooth or continuous state-feedback control laws when the vehicle has nonholonomic constraints. In the presence of currents, the desired orientation is not specified.
- *Trajectory tracking*: The vehicle is required to track a time-parameterized reference. For a fully actuated system, the problem can be solved with advanced nonlinear control laws; in the case of underactuated vehicles, i.e., the vehicle has less degrees of freedom than state variables to be tracked, the problem is still a very active topic of research.
- *Path following*: The vehicle is required to converge to and follow a path without any temporal specification. The assumption made in this case is that the vehicle's forward speed tracks a desired speed profile, while the controller acts on the vehicle orientation to drive it to the path. This typically allows a smoother convergence to the desired path with respect to the trajectory tracking controllers, less likely pushing to saturation the control signals.
- *Path maneuvering*: The knowledge about the vehicle's maneuverability constraints enables the design of speed and steering laws that allow for feasible path negotiation.

In recent years <AU: Please check whether "last years" can be changed to "recent years">, the above-mentioned scenarios have been extended to the case of coordinated and/or cooperative guidance of multiple vessels, basically introducing the concept of formation, i.e., geometric disposition of a set of vehicles.

As discussed in [8], a fleet of vessels can be required to track a set of predefined spatial paths while holding a desired formation pattern and speed (cooperative path following) to follow (in space) or track (in space and time) a moving target (cooperative target following and tracking, respectively). It is worth noting that these problems can be solved by converting them into an equivalent virtual target-based path-following problem. In particular, the so-called path-tracking scenario, in which the vehicle is required to track a target that moves along a predefined path, is the basic component of cooperative target-following/tracking systems. Indeed, with respect to trajectory tracking, path tracking separates the spatial and temporal constraints, giving priority to the former one, i.e., the vehicle tries to move along the path and then to zero the range from the target, as, for instance, in the case of a virtual

target moving at a desired range from a master vessel (vehicle-following scenario).

In this context, a number of preliminary experiments on multiple vehicle cooperative guidance were performed using combinations of USVs, autonomous underwater vehicles (AUVs), and manned vessels. Indeed, after first demonstrations carried out with autonomous kayaks SCOUT <AU: Please spell out "SCOUT."> in the United States to validate COLREGS <AU: Please spell out "COLREGS.">-based anticollision for UUVs [9], research focused on vehicle following, cooperative path following and target tracking, as well as mission coordination of multiple vehicles in the case of poor communication.

In particular, the need of collecting bathymetric data in an REA framework is strongly pushing research in vehicle following to support an operating scenario where a master vessel is followed on its sides by a flotilla of small USVs. The first full-scale experiment in a civilian setting worldwide, involving as USV a retrofitted leisure boat of length 8.5 with a maximum speed of 18 knots and as manned vehicle a research vessel of length 30 with an upper speed of 13 knots, was performed in Trondheimsfjord, Norway, on September 2008 [10]. In the following year, the experiment was replicated with a couple of slave vehicles following the master vessel [11] (a video describing the experiment can be found at http://www.youtube.com/watch?v=i_NrA5DwIcc).

Very interesting preliminary demonstrations of cooperative control of multiple UUVs, supported by a large theoretical work, were performed in the framework of the EC-funded project GREX [Instituto Superior Tecnico (IST)-Project No. 035223] about coordination and control of cooperating heterogeneous unmanned systems in uncertain environments. In particular, experiments oriented to evaluate the possibility of coordinating the operations of multiple AUVs in the presence of very limited underwater acoustic communications were carried out with the IFREMER's <AU: Please spell out "IFREMER."> AUVs Asterx and AUVortex in the Toulon area, France, on November 2008 [12]. During these trials, Asterx, the faster AUV, when measuring an excessive coordination error, sent the coordinates of a target point that the slower AUV, AUVortex, had to reach, while Asterx was circling around the waiting location.

Preliminary experiments, aiming at validating the execution of vehicle primitives, such as path following and target following, were carried out with the DELFIMx ASV <AU: Please spell out "DELFIM" and "ASV."> following the human-piloted boat Aguas Vivas by the researchers of the IST of Lisbon in Azores in May 2008 [8].

On November 2009, coordinated path-following experiments involving the USVs DELFIM and DELFIMx by the IST of Lisbon, the AUV SEABEE <AU: Please spell out "SEABEE."> by Atlas Elektronik, and the AUVortex by IFREMER were carried out in Sesimbra, Portugal [13].

The vehicles that operated on the surface communicating through a radio link had to follow paths composed by a segment of line, followed by an arc, and then finalized by a segment of line, while keeping an in-line formation, i.e., aligning themselves along a straight line perpendicular to the paths.

In the meantime, the autonomous kayaks SCOUT were exploited for evaluating the capacities of autonomous cooperation of AUVs and USVs in executing search tasks at sea, e.g., mine countermeasures [14], as well as for adaptive collection of oceanographic data, e.g., characterization of the sound speed profile with multiple USVs [15]. Very interesting experiments on the cooperative maneuvering of a couple of USVs for capturing a floating object and shepherding it to a designated position were carried out by the University of Southern California [16].

Vehicle Following

The problem of cooperative path following, where a slave vehicle follows a master maintaining a predefined position configuration, is addressed in this section. In particular, the proposed approach assumes that the slave vehicle doesn't a priori know the path to be followed: the master executes its motion, i.e., automatically following a path or being driven by a human operator and sends basic navigation information to the slave. From this reduced set of information (for instance, master's position, actual velocity, and orientation), the slave vehicle online reconstructs the path to be followed. This means that the only constraints on the master vessel are given by the fact that it has to be equipped with simple sensors and a communication system to send the navigation data to the slave vehicle.

The goal is to have a slave USV following the path of a master vessel at a fixed range, measured in terms of curvilinear abscissa of the desired path or linear distance in a specific direction in a suitable reference frame (typically, rigidly fixed to the master). Indeed, the problem consists of tracking an online-defined path, giving priority to the spatial constraints with respect to the temporal ones. Thus, since the main objective is that the two vehicles follow the same path, the proposed approach consists of three steps (executed at each control cycle):

- reconstructing the master path on the basis of continuously collected navigation data
- guiding the vehicle over the reference path according to a conventional path-following algorithm
- adapting the vehicle surge speed according to the error from the desired distance from the master.

It is worth noting that, according to research results presented in [6], the vehicle-following controller is designed at the guidance level generating reference yaw rate and surge, that, in the case of the Charlie USV, are tracked by suitable PI <AU: Please spell out PI.> gain-scheduling velocity controllers. In the operative framework used for validating the proposed approach, a slave vehicle is in charge of following exactly the shape of the path

executed by a human-driven master vessel, maintaining a desired position configuration with respect to it. For instance, the slave has to follow the master's path keeping a desired distance from its stern or (path-based) curvilinear distance between the two vehicles. While moving, the master transmits basic navigation information to the slave, i.e., horizontal position provided by GPS **<AU: Please spell out GPS.>**, when working with surface vessels, or acoustic positioning systems when underwater vehicles are involved. This basic information set can be augmented for instance adding when the master follows a predefined path, actual tangent and curvature values. Collecting the data provided by the master, the slave online generates a reference path that is followed using a Lyapunov-based guidance law improved with the virtual target approach, as presented in [6] and summarized in the following subsection. To maintain the desired range from the master, the slave's surge velocity is adapted according to a saturated proportional integral function of the desired distance, linear or curvilinear, between the two vehicles.

Virtual Target-Based Path Following

A brief description of the adopted path-following guidance algorithm for a single vehicle system follows. All the details of the proposed technique can be found in [6]. With reference to Figure 1, a Serret-Frenet frame $\langle f \rangle$ is attached to a virtual target VT moving along the path. The error vector connecting the virtual target VT to the vehicle V, expressed in $\langle f \rangle$, is $\underline{d} = [s_1 \ y_1]^T$ **<PE: As variables "d and x" were underlined in the author pdf, we have followed the same. Please check.>**. Thus, after straightforward computations, on the horizontal plane the error dynamics is given by the following equation system:

$$\begin{cases} \dot{s}_1 = -\dot{s}(1 - c_c y_1) + U \cos \beta, \\ \dot{y}_1 = -c_c \dot{s} s_1 + U \sin \beta, \\ \dot{\beta} = r_e - c_c \dot{s}, \end{cases} \quad (1)$$

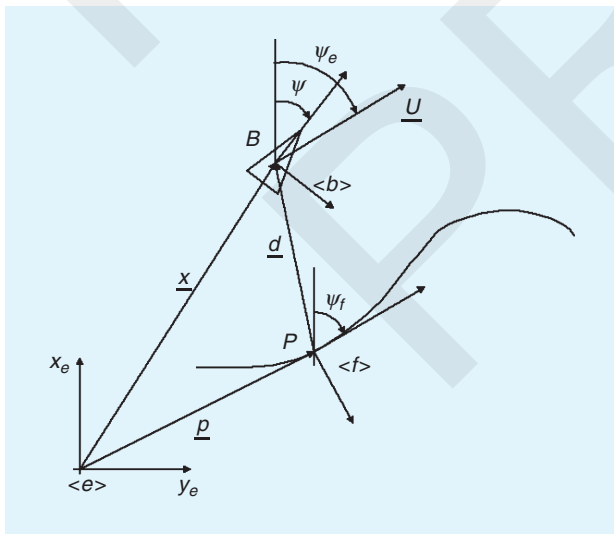

Figure 1. Vehicle's parameters and frames definition.

where $\beta = \psi_e - \psi_f$ is the angle of approach to the path, r^* and r_e are, respectively, the rotation rates of the vehicle and its velocity vector, which has an absolute value U , s represents the position of the virtual target VT over the path (i.e., curvilinear abscissa), and $c_c = c_c(s)$ is the signed curvature of the path. Defining the Lyapunov function $V = \frac{1}{2}(\beta - \varphi)^2$, the following control law for the yaw-rate input signal is obtained:

$$r^* = \frac{1}{\eta(t)} [\dot{\varphi} - k_1(\beta - \varphi) + c_c \dot{s}], \quad (2)$$

where $\eta(t)$ embeds the ratio between the angular speed of the vehicle's velocity vector and the vehicle's yaw rate, k_1 is a controller parameter, and φ is an odd function defining the actual angle approach, as a function of the distance y_1 from the path. A typical choice of $\varphi(y_1)$ is

$$\varphi(y_1) = -\psi_a \tanh(k_\varphi y_1), \quad (3)$$

where ψ_a is the maximum approach angle value and k_φ is a tunable function parameter. Moreover, it is worth noting that the speed \dot{s} of the target Serret-Frenet frame $\langle f \rangle$ constitutes an additional degree of freedom that can be controlled to guarantee the convergence of the vehicle at the desired path avoiding possible singularities. Indeed, the motion of the feedback control system restricted to the set E , where $\dot{V} = 0$, i.e., $\beta = \varphi(y_1)$, can be studied defining the Lyapunov function $V_E = (1/2)(s_1^2 + y_1^2)$. Considering that in the set E $y_1 \sin \varphi(y_1) \leq 0$ for the choice of $\varphi(y_1)$ in (3), the regulation law for the *virtual target* speed is computed as follows:

$$\dot{s}^* = U \cos \beta + k_2 s_1. \quad (4)$$

Vehicle Range Tracking

As introduced previously, the vehicle-following approach proposed in this work is based on the single-vehicle path-following guidance technique (2), combined with the continuous adaptation of the surge speed of the slave vehicle, with the aim of forcing the intervehicle distance to converge to and be maintained at a desired value.

The intervehicle distance D can be defined in different ways according to the mission requirements: the most common establishes the linear range between the vehicles, i.e., $D = \|\underline{x}_{\text{master}} - \underline{x}_{\text{slave}}\|$ **<PE: Please specify whether underline should be removed.>**, or the curvilinear distance between the *master* and *slave*, i.e., the difference between the respective curvilinear abscissas $D = \Delta s = s_{\text{master}} - s_{\text{slave}}$. Thus, the range tracking task consists of designing a control law to reach a desired distance D^* . Defining the distance error $e_s = D - D^*$, the simplest implemented solution to make $e_s \rightarrow 0$ is a PI control law that generates a surge speed reference signal u^* . This basic

solution can be easily improved by introducing a continuous saturation function to constrain the computed surge-speed reference within a minimum and maximum value, generating a feasible reference signal u_{sat}^* for the lower order surge speed controller:

$$\begin{cases} u^* = u_{ff} + K_p e_s + K_i \int e_s dt, \\ u_{\text{sat}}^* = C + \frac{u_{\text{max}} - u_{\text{min}}}{2} \tanh(\lambda u^* - C), \end{cases} \quad (5)$$

where K_p and K_i are, respectively, the proportional and integral gains of the controller, λ is a gain factor, and $C = u_{\text{min}} + ((u_{\text{max}} - u_{\text{min}})/2)$. The feed forward of the velocity of the master vehicle u_{ff} can be transmitted directly from the vessel itself or computed by the slave using, for instance, classic numerical derivation or some sort of filter. A minimum surge speed limit u_{min} , usually greater than zero, is needed to guarantee maneuverability, whereas the maximum speed limit u_{max} takes into account the physical constraints of the thrust actuation.

Sensing Issues

As introduced previously, the motion of the master and slave vehicles is estimated online on the basis of the measurements of aboard GPS and compass. Depending on the quality of the sensor measurements, issues in the smoothness of the estimated path or in the ground truthing of the estimated positions of the vehicles can turn up.

- *Estimation of the target path:* The steering control action, which is a function of the master path tangent and curvature as in (2), can be affected by the noise in their estimates. Indeed, a direct computation of the path tangent and curvature amplifies the noise of the GPS position measurements. Anyway, when the slave vehicle can be assumed to keep a certain distance from the master, a local smoothing for estimating the reference path is possible, thus reducing the impact of disturbance in position measurements. On the other hand, where the vehicles are required to maintain a parallel formation, only causal filtering techniques can be used for estimating the master's path.
- *Consistency of position measurements:* Although advanced guidance techniques usually guarantee that a vehicle follows a path with a desired precision, this is true for the estimated position of the vehicle that, as a consequence of disturbance on GPS measurements, could differ from the actual one also of some meters. Indeed, when a slave vehicle is required to follow the path of a master vehicle to collect data in the same places, the precision in executing this task is not only a function of the performance of the guidance and control modules but also of the consistency of the position measurements collected aboard the two vehicles. Thus, special attention to ground-truth verification of the followed path has to be paid when performing field trials.

Experimental Setup

Experiments have been carried out with the Charlie USV and ALANIS dual-mode vessel in a rowing regatta field inside the Genova Prà harbor, Italy, on July 2009. According to the requirements specified by the Hydrographic Institute of the Italian Navy, the experiments focused on the high-precision vehicle following to provide, although in a protected environment, a preliminary feasibility demonstration of the proposed technology and to validate the basic architecture requirements in terms of control, communication, and sensing systems. In the following, after a short introduction of the basic characteristics of the vehicles involved in the demonstration, a detailed presentation of their adaptation, required to support the experiments, will be given together with a description of the adopted navigation sensors.

Charlie USV

The Charlie USV [4] is a small autonomous catamaran prototype that is 2.40 m long, 1.70 m wide, and weighs about 300 kg in air (see Figure 2). The vessel, originally designed and developed by CNR-ISSIA, Genova, for sampling sea surface microlayer and collecting data on the air-sea interface in Antarctica, is propelled by two dc thrusters whose revolution rate is controlled by a couple of servo amplifiers, closing a hardware speed control loop with time constant negligible with respect to the system. With respect to the original version, where steering was guaranteed by the differential revolution rate of the propellers, the vehicle has been upgraded with a rudder-based steering system constituted by two rigidly connected rudders, positioned behind the propellers, and actuated by a brushless motor. The standard vessel navigation package is constituted by a GPS Ashtech GG24C integrated with a KVH <AU: Please spell out KVH.> Azimuth Gyrotrac providing the true north. The electrical power supply is provided by four 12 V at 40 Ah lead batteries integrated with four 32 W triple junction, flexible solar panels.



Figure 2. A view of the Charlie USV in the Genova Prà harbor. <AU: Please confirm that permission has been granted by the copyright owner to print this photo and please provide proper credit line.>



Figure 3. ALANIS USV. <AU: Please confirm that permission has been granted by the copyright owner to print this photo and please provide proper credit line.>

Communications with the remote control and supervision station are guaranteed by a radio wireless LAN at 2.4 GHz with a maximum data transfer rate of 3 Mb/s, supporting robot telemetry, operator commands, and video image transmission. Owing to poor performance, mainly in terms of reliability, offered by commercial, relatively low cost, wireless line-of-sight links, the communication system has been upgraded with a radio modem working at 169 MHz with a transfer rate of 2,400 b/s, guaranteeing a safe transfer of commands and basic telemetry. Indeed, the radio modem link acts as a backup channel, due to the frequent and unpredictable main wireless link disconnections, allowing to send a basic command set to drive or recover the vehicle.

The human operator station is formed by a laptop computer, running a human computer interface, implemented originally in C++ and then in Java, and the power supply system, which integrates a couple of solar panels (32 W at 12 V) and one lead battery (100 Ah at 12 V), thus, guaranteeing its full autonomy and portability.

ALANIS Dual-Mode USV

The ALANIS USV [5] is a 4.50-long, 2.20-m wide rubber dinghy-shaped aluminum vessel with a 40 HP Honda outboard motor (see Figure 3). It weighs 600 kg and has an autonomy of about 12 h guaranteed by a fuel capacity of 65 L <AU: Please check whether “65 L” is given correctly.>. A motorized winch can be mounted on board for automatic deployment and recovery of scientific instrumentation through a stern hole of 0.20 m diameter. The basic navigation package is formed by a Garmin GPS 152 with 12 parallel channels, a navicontrol smart compass SC1G, and a dual-axis applied geomechanics IRIS MD900-TW <AU: Please spell out “IRIS MD900-TW”.> wide-angle clinometer providing accurate pitch and roll measurements. A manually (dis-)connectible electromechanical system for servoactuating the vessel steering and throttle allows the dual use of the vehicle as a manned and an unmanned platform. Indeed, the possibility of having a crew onboard and fast switching control to a human pilot has been motivated by the lack of rules for operating unmanned vehicles at sea. For these reasons, when working in the automatic mode, the human–computer interface, which has the same architecture as the operator station of the Charlie USV, is kept aboard the vessel itself. The basic navigation, guidance, and control system implemented on a single-board computer-based architecture running GNU/Linux OS <AU: Please spell out “GNU.”> consists of PD <AU: Please spell out “PD.”> auto heading and LOS <AU: Please spell out “LOS.”> way-point guidance.

Charlie and ALANIS Adaptation

To implement a master–slave vehicle-following scheme of the class discussed in the “Vehicle Following” section, the master vessel has to communicate its basic navigation information to the slave vehicle. This implies the installation of a radio link supporting the transmission of ALANIS navigation data to the Charlie USV. This additional link, a radio modem channel working at 436 MHz with a transfer rate of 2,400 b/s, is seen by the slave control system as an additional sensor providing the measurements required by the vehicle-following guidance module, i.e., GPS position, course, and speed. The resulting communication scheme is depicted in Figure 4.

It is worth noting that due to safety reasons, i.e., to have both the vehicles under strict visual control by the human supervisor when executing automatic coordinated maneuvers in an area with recreational traffic, the basic operator station of the Charlie USV, consisting of a laptop and a wireless communication

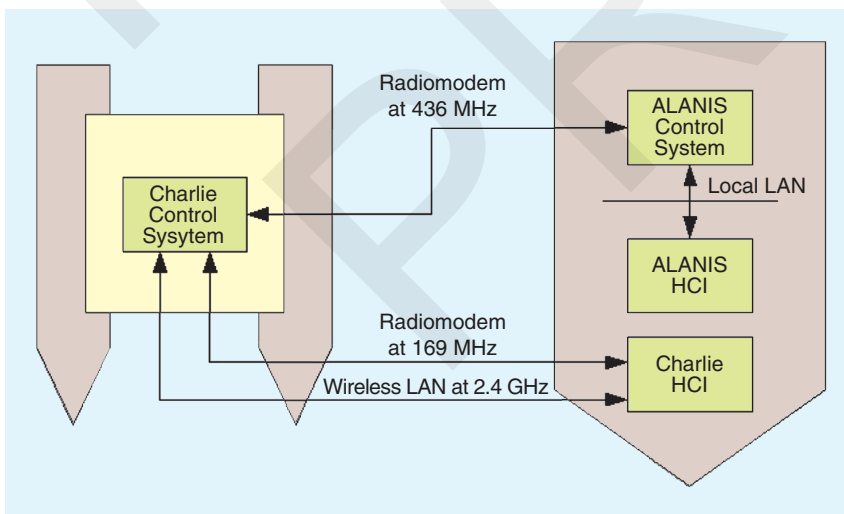

Figure 4. Charlie–ALANIS network configuration.

link, has been mounted onboard the ALANIS vessel to perform the experiments. Moreover, to improve the localization performance and navigation accuracy, according to the issues discussed in the “Sensing Issues” section, the two vehicles have been equipped with a couple of Omnistar HP-8300 high-positioning GPS receivers with a 95% accuracy, supplied by the Hydrographic Institute of the Italian Navy.

Test Site

Experimental tests have been carried out in the Genova Prà harbor, a calm water channel devoted to rowing races (44°25'32" N, 8°46'48" E), at the end of July 2009, in a day with no significant wind disturbance. As shown in the following, the presence of white buoys delimiting the lines of the regatta field has been very useful for visual ground-truth evaluation of the system performance.

Experimental Results

Field trials, aiming at validating the proposed approach, have been carried out with the slave Charlie USV following the master ALANIS vessel piloted by a human operator. As discussed previously, the master vessel sends to the slave vehicle its fundamental navigation data (position, course, and speed). The result is that the slave follows the actual path of the master at less errors than in the intercalibration of the GPS receivers mounted on the two vehicles. To experimentally evaluate the amount of this intercalibration error using GPS devices of different classes, dedicated preliminary tests have been performed.

GPS Performance

To evaluate the GPS performance, in terms of measurement noise and time-variable offset between two different devices, the measured range between a couple of GPS antennas positioned at a constant distance has been evaluated. Indeed, since the main goal of the guidance task is to force the two vehicles to navigate along the same path, a constant bias in measurements carried out by different devices is required. Preliminary tests, performed in the framework of the ALANIS project, demonstrated that, using different conventional low-cost devices the difference between simultaneous measurements of position could be of the order of some meters. During the experiments, three devices, i.e. a Garmin GPS 152, a GPS Ashtech GG24C, and a Trimble GPS Pathfinder Pro XRS <AU: Please spell out XRS.>, made available by the Hydrographic Institute of the Italian Navy, were mounted on the ALANIS USV maneuvering inside the harbor.

As shown in Figure 5, their measured distances were not constant, varying up to 5 m in the case of Garmin and Ashtech devices. Further tests, carried out with a couple of identical Omnistar HP-8300 high-positioning GPS, supplied by the Hydrographic Institute of the Italian Navy, revealed a dramatic performance improvement, obtaining,

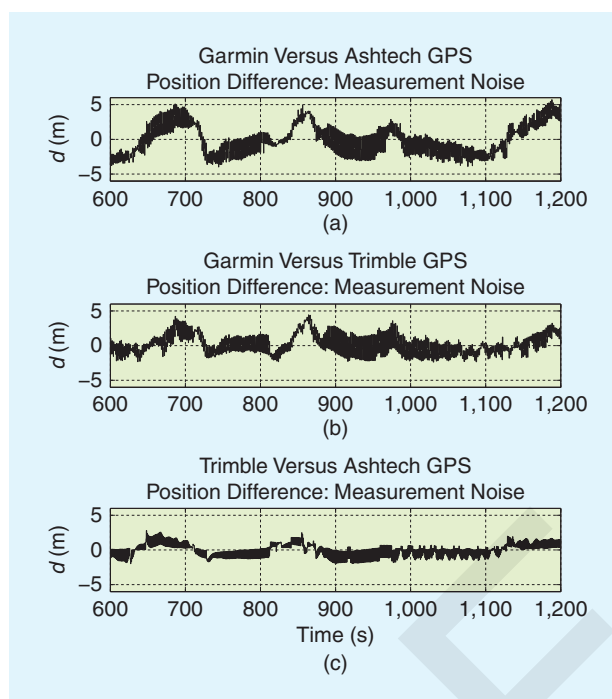

Figure 5. The measured distance error between different GPS receivers. (a)–(c): Garmin versus Ashtech, Garmin versus Trimble, and Trimble versus Ashtech.

as depicted in Figure 6(b), the measured range error between the devices that was always lower than 0.1 m.

Vehicle Following

As previously discussed, experimental tests were manually performed driving the ALANIS vessel in the Genova Prà harbor at an advance speed of about 1 m/s. It is worth

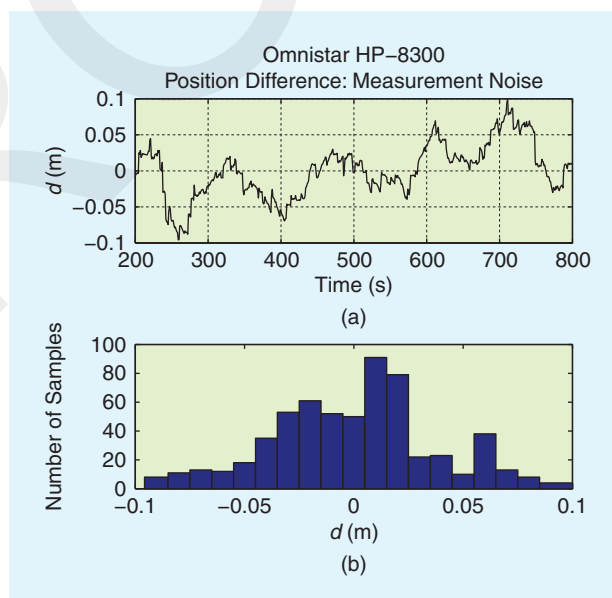

Figure 6. The measured distance error between two identical Omnistar HP-8300 high-positioning GPS receivers. (a) Measurement record in time and (b) range histogram.

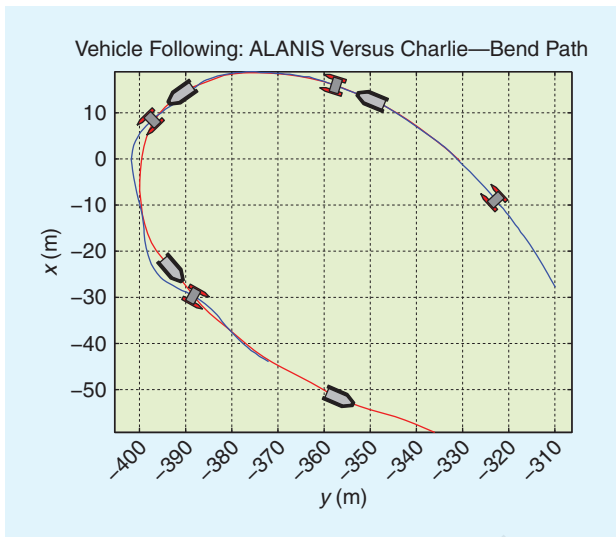

Figure 7. The vehicle-following experimental results: Path of the master vessel ALANIS and the slave USV Charlie while executing a large radius U-turn.

noting that the human pilot had to be very careful in executing a path as free as possible of high curvature stretches. Indeed, since the slave Charlie USV has a slower steering dynamics than the master ALANIS vessel, narrow or tricky maneuvers could lead to a divergence from the reference

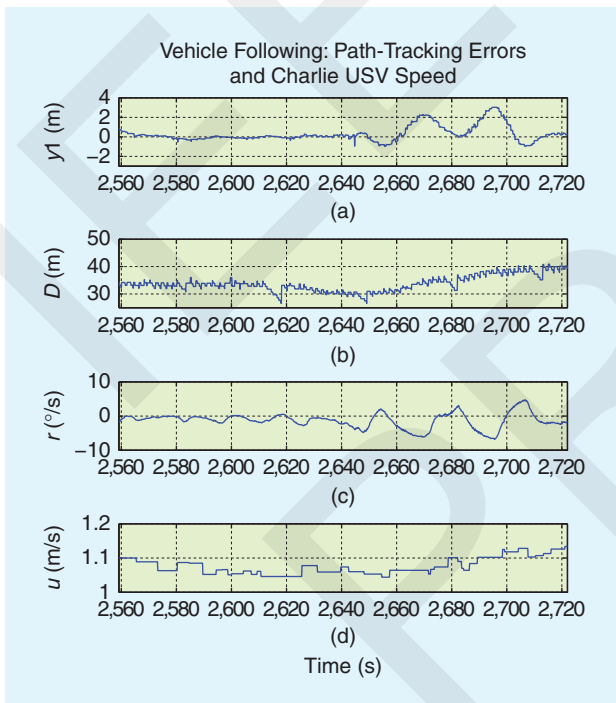

Figure 8. The vehicle-following experimental results—large radius U-turn: path-tracking errors and the slave USV speed. (a) Lateral range error, (b) master–slave distance, (c) Charlie USV yaw-rate, and (d) Charlie USV surge. **<PE: As in the input file “top to bottom,” was given, we have used the labels as (a)-(d). Please check.>** **<AU: Please check if the subcaptions are correct. Please provide the complete subcaptions, if needed.>**

target causing oscillating motions of the slave to recover the desired path. Oscillations of the vehicle motion around the reference path, originated by a significant overshoot when converging to a path at a high speed with respect to the steering dynamics [6], could be very dangerous when working in restricted areas in the presence of fixed obstacles (e.g., rocks, parked boats, and quays) and recreational traffic.

To evaluate the performance of the proposed algorithm, different path shapes have been considered focusing attention on bending maneuvers and the possibility of executing repetitive tests in similar operating conditions. For instance, Figure 7 shows the path followed by the master vessel ALANIS and the slave USV Charlie while executing a U-turn maneuver presenting a reduction in the curvature radius toward the end of the bend. This induced a slight sliding of the Charlie USV toward outside, clearly visible in the log of the lateral range y_1 from the target path [see Figure 8(a) in the time interval between 2,650 and 2,720 s].

The trend of the range between the master and slave vehicles, plotted in Figure 8(b), reveals the difficulties in accomplishing the secondary task of the path-tracking problem, i.e., satisfying the time constraints, while guaranteeing high precision by following the desired curvilinear path. Indeed, to remain on the desired track, the slave vessel reduced its speed while bending to accelerate when curvature decreases. The precision of the proposed system in tracking the master path was evaluated performing a kind of slalom between a sequence of buoys delimiting the regatta field lanes. Repetitive tests were performed, where the presence of the buoys allowed a visual ground-truth verification of the performance of the proposed vehicle-following system, including the validation of the consistency of the position measurements supplied by the GPS devices aboard the two vehicles.

An example is reported in Figure 9 where the passage of the master and slave vehicles between a couple of white buoys is shown. (A video documentation of the trials with simultaneous views of the vehicles and their estimated path is available on the Web at http://www.umv.ge.issia.cnr.it/video/vessel_following.html.) As far as the repeatability of system performance in similar conditions is concerned, the master vessel was guided by the human pilot through the buoys approximately along the same path in different passages. As shown in Figure 10, where a couple of passages are shown, the ALANIS pilot (Mr. Edoardo Spirandelli by CNR-ISSIA) was able to execute very precise maneuvers; thanks to the visual help provided by buoys. As shown in Figure 11, the lateral shift in following the path of the master vessel, during these maneuvers, was higher than 1 m (often higher than 0.5 m).

In particular, the mean precision \bar{A}_{ss} of the guidance system in the steady state has been defined as the area A_{ss} between the actual and the desired path normalized with respect to the length Δs_{ss} of the reference path (see [6] for more details). The computed values for the paths

1 and 2, represented in Figure 10, in the interval $y \in [-240\text{m}, -140\text{m}]$ are reported in Table 1. It is worth noting that the computed values of \bar{A}_{ss} are similar to the ones computed in the path-following experiments reported in [6] where a mean value of 0.74 was computed.

At the end of the maneuver shown in Figures 7 and 8, the increasing range between the vessels is visible when the master accelerates to go along a low curvature line while the slave is still turning. The higher lateral shift at the beginning of path 2 [time between 3,150 and 3,180 s in Figure 11(c)] shows the behavior of the Charlie USV during a transient phase when coming from a narrow-range U-turn that is visible in Figure 12. The different capabilities in low surge turning of the Charlie and ALANIS vessels are clearly visible.

The research and experiments described in this article present significant analogies with the work carried out in the GREX project with the DELFIMx ASV following the human-piloted boat Aguas Vivas [8]. In the case discussed here, no vehicle primitives, e.g., straight lines and arcs,

were defined, representing any generic path as a simple sequence of points, close to each other, with the associated local tangent and curvature. Anyway, the differences in the performance with respect to the result presented in [8] are evaluable in a difficult way due to different experimental conditions: the higher precision in path following of the

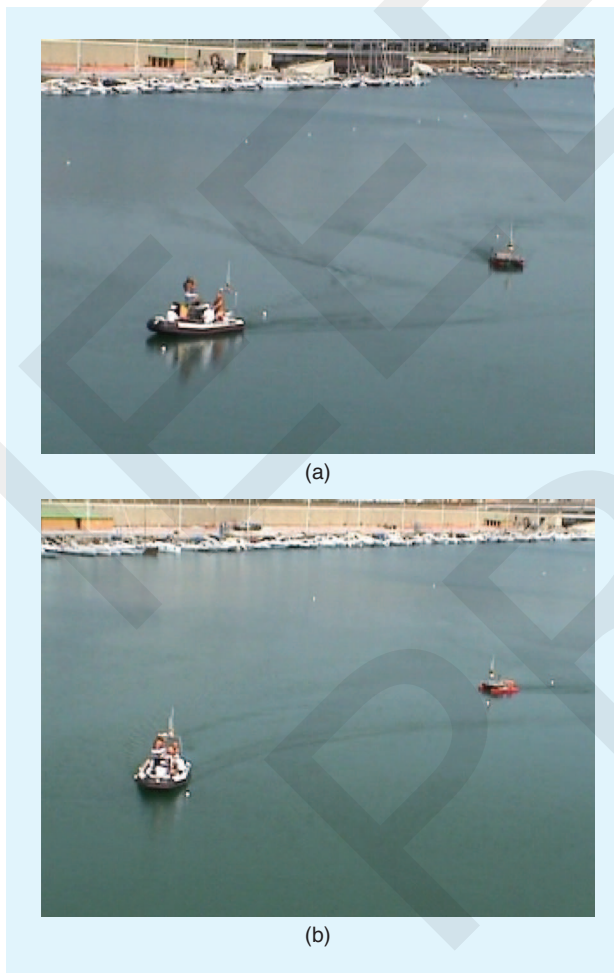

Figure 9. The vehicle-following ground truthing: (a) Passage of the master vessel ALANIS and (b) the slave USV Charlie between the same couple of white buoys. <AU: Please confirm that permission has been granted by the copyright owner to print these photos and please provide proper credit line.>

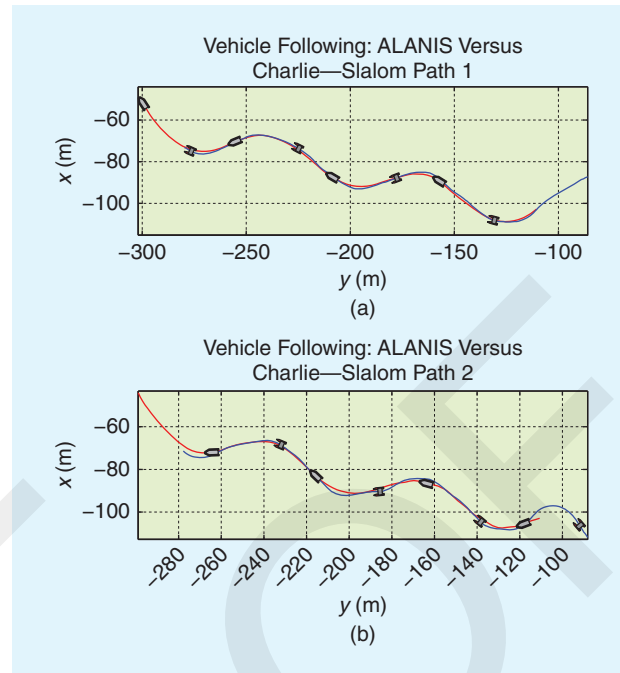

Figure 10. The vehicle-following experimental results—An example of the path followed in two similar (repetitive) experiments. Red and blue lines denote the ALANIS and Charlie paths, respectively.

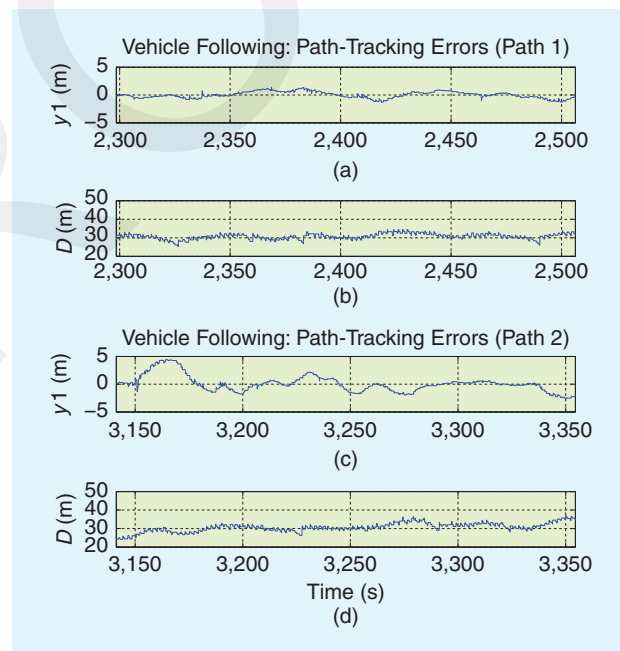

Figure 11. The vehicle-following experimental results—(a)–(d) Path tracking errors (lateral shift) and the vessel range in two similar (repetitive) experiments.

Table 1. A path-following performance index—Slalom paths.

	A_{ss}	Δs_{ss}	\bar{A}_{ss}
Path 1	68.48	113.52	0.60
Path 2	83.10	113.84	0.72

experiments presented here can be likely due to the smoother sea state inside the harbor than along the Azores coastline, besides the different dynamics of the vessels involved.

Lessons Learned

The above-presented research with the theoretical and experimental results, independently achieved by the Norwegian University of Science and Technology and the company Maritime Robotics and the Instituto Superior Tecnico of Lisbon, Portugal, demonstrates that the basic issues concerning the task of USV following have been solved. In particular, this research as well as the results obtained in the GREX project and the examples reported in [17] demonstrate how the virtual target-based guidance, originally formulated for wheeled ground robots in [18], is very effective and practical for handling multivehicle cooperation in marine environment.

As discussed in the “Experimental Results” section, although the performance is mainly limited by the quality of the sensor data, the last-generation high-positioning GPS devices guarantee a satisfactorily accuracy in the measured position for many applications without requiring the installation of a base station for a differential system. Further research efforts are required for improving the speed control of the slave vehicle, i.e., the weak aspect pointed out by the experiments presented in this article,

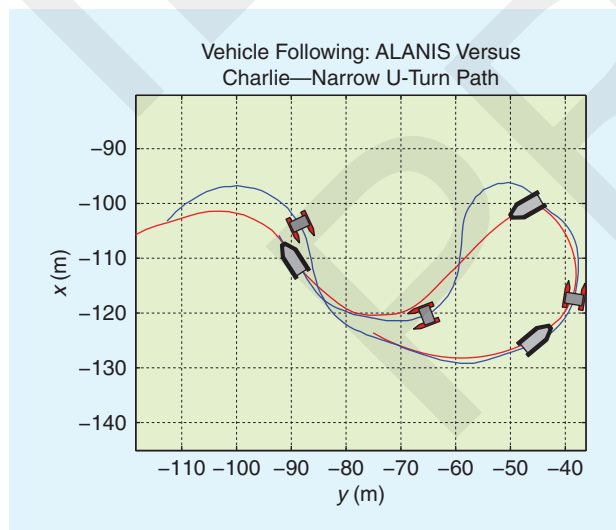

Figure 12. The vehicle-following experimental results—Example of narrow U-turn of the master vessel. Red and blue lines denote the ALANIS and Charlie paths, respectively.

introducing, if necessary, some heuristics to increase the system performance in executing the secondary task of the path-tracking problem, i.e., satisfying the time constraints and minimizing the effects of oscillations around the desired path <AU: Please check whether “and” is inserted at the right place.>. Moreover, accurate studies for adapting the proposed guidance algorithms to the presence of significant wind disturbance, including the definition of enough accurate models of the vehicle behavior in those conditions, should be carried out.

In-field experimental activity revealed the fundamental role played by the availability of reliable robotic platforms and communication infrastructure as well as the large amount of human resources devoted to their development, adaptation, and integration. In addition, critical issues were encountered when trying to execute good experiments in terms of defining practical procedures, metrics, and experimental conditions and performing repeatable trials:

- *Ground truthing:* The availability of fixed buoys, as well as the synchronization of the vehicle telemetries with the recorded videos through the use of the USV siren, logged in the USV telemetry and clearly audible in the video audio track, allowed an immediate, at first glance, evaluation of the system accuracy when executing trials in restricted waters, e.g., harbor area. In any case, the performance of suitable GPS devices is such that an instrumental validation of system accuracy can be sufficient, although less impressive to an external evaluator.
- *Performance metrics:* Metrics, defined in [6] for evaluating the path-following performance, i.e., satisfying the spatial constraints, are reasonable and easy to be applied. Further metrics for evaluating the performance in satisfying the time constraints have to be defined and their computation has to be implemented.
- *Test repeatability:* As shown in Figure 10, with the help of visual landmarks such as fixed buoys, the human pilot could approximately drive the master vessel along the same path during different experiments. Anyway, since the effectiveness of the communication infrastructure and GPS measurement consistency have been demonstrated, further experiments, mainly devoted to improve performance in terms of satisfaction of the time constraints, could be executed providing as input to the slave USV previously recorded trajectories of the master vessel. For this aim, the trajectory of the ALANIS vessel during the experiments reported in this article is made available at http://www.umv.ge.issia.cnr.it/video/vessel_following.html, thus providing a small contribution to the diffusion of data sets about marine robotics applications.

Conclusions

Preliminary experimental results demonstrating the effectiveness of a vehicle-following guidance system for USVs based on the concept of virtual target have been presented and discussed, after a brief presentation of the proposed approach. The above-presented research as well as a few

other similar demonstrations cited in the text contribute to bridge the gap between theory and practice in the field of UMVs encouraging the application of this emerging technology not only in military scenarios but also in civilian applications.

Acknowledgments

This research has been partially funded by the CNR-CNRS <AU: Please spell out "CNR."> bilateral agreement *Coordinated mission control for autonomous marine vehicles* and Parco Scientifico e Tecnologico della Liguria s.c.p.a.

The authors thank the Hydrographic Institute of the Italian Navy for supplying high-positioning GPS devices and participating in the definition of the multivehicle maneuvers. Moreover, the authors also thank Giorgio Bruzzone and Edoardo Spirandelli for their activity in the development and operation of the ALANIS and Charlie USVs, Riccardo Mantovani for the video documentation of the experiments, and the personnel of A.S.D.P.S. Prà Sapello for their kind support to the execution of sea trials.

References

- [1] A. Pascoal, C. Silvestre, L. Sebastiao, M. Rufino, V. Barroso, J. Gomes, G. Ayela, P. Coince, M. Cardew, A. Ryan, H. Braithwaite, N. Cardew, J. Trepte, N. Seube, J. Champeau, P. Dhaussy, V. Sauce, R. Moiti, R. Santos, F. Cardigos, M. Brussieux, and P. Dando, "Robotic ocean vehicles for marine science applications: The European ASIMOV project," in *Proc. Oceans*, Providence, RI, Sept. 2000, <AU: Please provide the complete page range.>.
- [2] J. Manley, "Unmanned surface vehicles, 15 years of development," in *Proc. MTS/IEEE Oceans'08*, Quebec City, Canada, Sept. 2008 <AU: Please provide the complete page range.>.
- [3] L. Gasperini, "Extremely shallow-water morphobathymetric surveys: The Valle Fattibello (Comacchio, Italy) test case," *Marine Geophys. Res.*, vol. 26, pp. 97–107, 2005 <AU: Please provide the issue number.>.
- [4] M. Caccia, M. Bibuli, R. Bono, G. Bruzzone, G. Bruzzone, and E. Spirandelli, "Unmanned surface vehicle for coastal and protected water applications: The Charlie project," *Marine Technol. Soc. J.*, vol. 41, no. 2, pp. 62–71, 2007.
- [5] M. Caccia, M. Bibuli, and G. Bruzzone, "Aluminim autonomous navigator for intelligent sampling: The ALANIS project," *Sea Technol.*, 2009 <AU: Please provide the volume and issue number(s) and page range.>.
- [6] M. Bibuli, G. Bruzzone, M. Caccia, and L. Lapiere, "Path-following algorithms and experiments for an unmanned surface vehicle," *J. Field Robot.*, vol. 26, no. 8, pp. 669–688, 2009.
- [7] M. Breivik and T. Fossen, "Guidance laws for planar motion control," in *Proc. 47th IEEE Conf. Decision and Control*, Cancun, Mexico, Dec. 2008, pp. 570–577.
- [8] A. Aguiar, J. Almeida, M. Bayat, B. Cardeira, R. Cunha, A. Häusler, P. Maurya, P. Oliveira, A. Pascoal, A. Pereira, M. Rufino, L. Sebastião, C. Silvestre, and F. Vanni, "Cooperative control of multiple marine vehicles," in *Proc. 8th IFAC Int. Conf. Manoeuvring and Control of Marine Craft*, Guarujá, Brasil, Sept. 16–18, 2009, <AU: Please provide the complete page range.>.

- [9] M. Benjamin, J. Curcio, and P. Newman, "Navigation of unmanned marine vehicles in accordance with the rules of the road," in *IEEE Proc. Int. Conf. Robotics and Automation*, 2006, pp. 3581–3587.
- [10] M. Breivik. (2009). *Formation control with unmanned surface vehicles*. Centre for Ships and Ocean Structures, Norwegian Univ. Sci. Technol., Tech. Rep. [Online]. Available: http://www.ivt.ntnu.no/imt/courses/tmr4240/literature/formation_control_usvs.pdf.
- [11] M. Breivik, "Topics in guided motion control of marine vehicles," Ph.D. dissertation, Dept. Eng. Cybern., Norwegian Univ. Sci. Technol. 2010.
- [12] T. Alves, L. Brignone, M. Schneider, and J. Kalwa, "Communication infrastructure for fleets of autonomous marine vehicles: concepts and first results," in *Proc. 8th IFAC Conf. Manoeuvring and Control of Marine Craft*, 2009 <AU: Please provide the complete page range.>.
- [13] J. Kalwa, "Final results of the European Project GREX: Coordination and control of cooperating marine robots," in *Proc. 7th IFAC Symp. Intelligent Autonomous Vehicles*, 2010 <AU: Please provide the complete page range.>.
- [14] A. Shafer, M. Benjamin, J. Leonard, and J. Curcio, "Autonomous cooperation of heterogeneous platforms for sea-based search tasks," in *Proc. Oceans*, 2008 <AU: Please provide the complete page range.>.
- [15] J. Curcio, T. Schneider, M. Benjamin, and A. Patrikalakis, "Autonomous surface craft provide flexibility to remote adaptive oceanographic sampling and modeling," in *Proc. Oceans*, 2008 <AU: Please provide the complete page range.>.
- [16] F. Arrichiello, H. Heidarsson, S. Chiaverini, and G. Sukhatme, "Cooperative caging using autonomous aquatic surface vehicles," in *Proc. IEEE Int. Conf. Robotics and Automation*, 2010 <AU: Please provide the complete page range.>.
- [17] M. Bibuli, L. Lapiere, and M. Caccia, "Virtual target based coordinated path-following for multi-vehicle systems," in *Proc. 8th IFAC Conf. Control Applications in Marine Systems*, 2010 <AU: Please provide the complete page range.>.
- [18] L. Lapiere, D. Soetanto, and A. Pascoal, "Adaptive, non-singular path-following of dynamic wheeled robots," in *Proc. 42nd IEEE Conf. Decision and Control*, Maui, HI, Dec. 2003 <AU: Please provide the complete page range.>.

Marco Bibuli, Istituto di Studi sui Sistemi Intelligenti per l'Automazione, Consiglio Nazionale delle Ricerche, Genova, Italy. E-mail: marco.bibuli@ge.issia.cnr.it.

Massimo Caccia, Istituto di Studi sui Sistemi Intelligenti per l'Automazione, Consiglio Nazionale delle Ricerche, Genova, Italy. E-mail: max@ge.issia.cnr.it.

Lionel Lapiere, Laboratoire d'Informatique, Robotique et Micro-électronique de Montpellier of CNRS, Montpellier, France. E-mail: lapiere@lirmm.fr.

Gabriele Bruzzone, Istituto di Studi sui Sistemi Intelligenti per l'Automazione, Consiglio Nazionale delle Ricerche, Genova, Italy. E-mail: gabry@ian.ge.cnr.it.

BR

USVs, given their position at the air–sea interface, can play a key role both in relaying radio-frequency transmissions in air and acoustic transmissions undersea.

USVs are seen as a part of flotillas of heterogeneous vehicles executing large-scale surveys and supporting REA.

Charlie USV is propelled by two dc thrusters whose revolution rate is controlled by a couple of servo amplifiers.

Field trials, aiming at validating the proposed approach, have been carried out with the slave Charlie USV following the master ALANIS vessel piloted by a human operator.

In-field experimental activity revealed the fundamental role played by the availability of reliable robotic platforms and communication infrastructure as well as the large amount of human resources devoted to their development, adaptation, and integration
