



HAL
open science

Greedy algorithms for time-frequency allocation in a SDMA satellite communication system

Kata Kiatmanaroj, Christian Artigues, Laurent Houssin, Erwan Corbel

► **To cite this version:**

Kata Kiatmanaroj, Christian Artigues, Laurent Houssin, Erwan Corbel. Greedy algorithms for time-frequency allocation in a SDMA satellite communication system. 9th International Conference on Modeling, Optimization & SIMulation, Jun 2012, Bordeaux, France. hal-00728645

HAL Id: hal-00728645

<https://hal.science/hal-00728645>

Submitted on 30 Aug 2012

HAL is a multi-disciplinary open access archive for the deposit and dissemination of scientific research documents, whether they are published or not. The documents may come from teaching and research institutions in France or abroad, or from public or private research centers.

L'archive ouverte pluridisciplinaire **HAL**, est destinée au dépôt et à la diffusion de documents scientifiques de niveau recherche, publiés ou non, émanant des établissements d'enseignement et de recherche français ou étrangers, des laboratoires publics ou privés.

Greedy algorithms for time-frequency allocation in a SDMA satellite communication system

K. KIATMANAROJ, C. ARTIGUES, L. HOUSSIN

CNRS; LAAS; 7 av. du Colonel Roche, F-31077, Toulouse, France
Université de Toulouse; UPS, INSA, INP, ISAE; UT1, UTM, LAAS
F-31077 Toulouse, Cedex 4, France
kkiatman@laas.fr, artigues@laas.fr, houssin@laas.fr

E. CORBEL

Thales Alenia Space
26 av. J.F. Champollion
31037 Toulouse, France
erwan.corbel@thalesalieniaspace.com

ABSTRACT: *In satellite communication, Spatial Division Multiple Access (SDMA) has become one of the most promising techniques that can accommodate continuing increase in the number of users and traffic demands. The technology is based on radio resource sharing that separates communication channels in space. It relies on adaptive and dynamic beam-forming technology and well-designed algorithms for resource allocation. This paper presents greedy algorithms to handle 2-dimensional resource allocation (time \times frequency) in a highly complex SDMA satellite communication system. The objective is to maximize the number of users that the system can serve while maintaining the signal to interference plus noise ratio of each user under a predefined threshold. Traditionally, interference is treated as binary and fixed. In this paper, the interference is cumulative and variable.*

KEYWORDS: *Greedy algorithm, SDMA, Satellite*

1 INTRODUCTION

Satellite communications have revolutionized the world we live in. Fixed and mobile telephone services, television broadcast, internet access, and a large number of applications have changed the way people all over the globe interact. With the continuing increase in traffic demand, satellite communication technology continuously evolves and move towards greater capacity, higher flexibility, and better services. Spatial Division Multiple Access (SDMA) appears to be an alternative to achieve these requirements simultaneously (Liberti & Rappaport 1999). The technology employs antenna arrays and multi-dimensional non-linear signal processing techniques to provide significant increases in capacity and quality of many wireless communication systems (Roy 1998). The technology is not restricted to any particular modulation format or air-interface protocol, and is compatible with all currently deployed air-interfaces (Roy 1997).

An SDMA satellite equips with multi-spot-beam antenna (Giambene 2007) that transmit signals to numerous zones on the Earth's surface. The antennas are highly directional, allowing the same frequency to be reused in other surface zones where the frequency separation is sufficiently large. To support a large number of users, frequency selection should be performed carefully. The frequency assignment strategy thus plays an important role in the system

performance. This class of problem is well-known as Frequency Assignment Problem (FAP) (Hale 1980), (Leese & Hurley 2002). A survey on frequency assignment is provided in (Aardal, van Hoesel, Koster, Mannino & Sassano 2003).

The satellite communication system that we study in this paper aims at establishing bi-directional communication links to user terminals located in a service area. Each user demands can be accommodated by allocating a portion of time and a number of frequencies while the system provides fixed amount of these resources. Users can share time or frequency or both while the latter case creates interference. The interference is cumulative. The goal is to assign as many users as possible while keeping the interference level under a certain threshold for the communication link to remain functioning. This time and frequency resource allocation problem could resemble 2D bin packing problem (Lodi, Martello & Monaci 2002), nonetheless, with additional cumulative interference constraints and is rare in the literature.

Moreover, the system incorporates actual requirements and constraints provided by the industry. These factors give rise to a highly complex problem. Another requirement is to accommodate mobility function; thus, low calculation time is needed as allocation plans must be recomputed frequently. With these requirements, exact methods such as In-

teger Linear Programming (ILP) method are impractical. Instead, we propose greedy algorithms.

The paper is organized as follows: Section 2 provides the description of the telecommunication system; in Section 3, we describe the proposed greedy algorithms. Section 4 presents the experimental results while conclusions are given in Section 5.

2 SYSTEM DESCRIPTIONS

In general, a satellite communications system consists of a satellite, a gateway, and a number of users within a service area. The satellite provides bi-directional communication links towards users and acts as a relay point between them and the gateway, the node that connects the satellite system to the terrestrial network. In this study, we consider only the satellite, the users, and communication links between them, see figure 1.

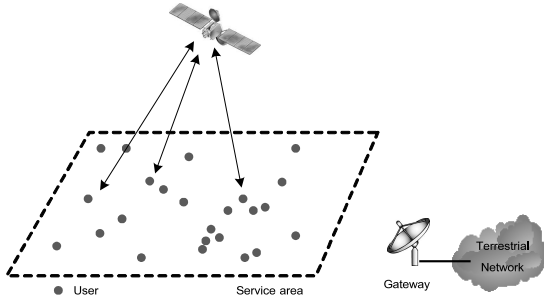

Figure 1: A satellite communications system.

Users are randomly generated inside the service area. Actual communication link parameters are used in order to determine the user's signal and noise levels. The satellite antenna utilizes SDMA technology to form energy beams and center them over the required positions. The perceived antenna gain for a specific user's position is determined by the radiation pattern of the antenna, the beam's position, and the user's position (Houssin, Artigues & Corbel 2011) *i.e.* $G_{Sat}(u, v, u_0, v_0) = G_1 \cdot G_2(u, v, u_0, v_0) \cdot G_3(u, v)$ where $G_1 = \eta \left(\frac{\pi D}{\lambda}\right)^2$, $G_2(u, v, u_0, v_0) = \left(\frac{2J_1\left(\frac{\pi D}{\lambda} \sqrt{(u-u_0)^2 + (v-v_0)^2}\right)}{\frac{\pi D}{\lambda} \sqrt{(u-u_0)^2 + (v-v_0)^2}}\right)^2$, and $G_3(u, v) = \left(\frac{2J_1\left(\frac{\pi d}{\lambda} \sqrt{u^2 + v^2}\right)}{\frac{\pi d}{\lambda} \sqrt{u^2 + v^2}}\right)^2$.

$J_1(x)$ represents the Bessel function of the first kind while u, v and u_0, v_0 are Cartesian coordinates of the user and the beam positions. η, D, d and λ are the antenna efficiency, the antenna diameter, the diameter of the antenna's primary source and the carrier wavelength, respectively. The corresponding antenna diagram is shown in figure 2 (z-axis in log scale).

The objective of the study is to serve as many users as

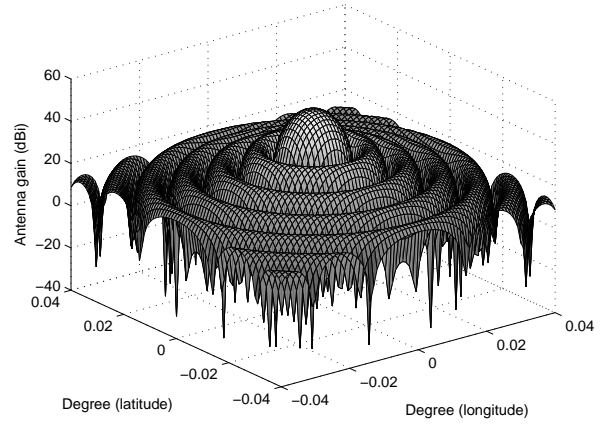

Figure 2: Example of antenna diagram.

possible. A user is considered served if it is allocated with a resource in time and frequency satisfying the technical constraints and link budget constraint. The link budget constraint is giving by that the user's signal (C) to interference (I) plus noise (N) ratio (SINR) is no less than the required signal to noise ratio, as $\frac{C}{N+I} \geq \left(\frac{C}{N}\right)_{Required}$.

Figure 3 shows cross sections ($Y = 0$) of three satellite beams associated to and centered at users i, j, k located at three different positions. Let's assume uniform receivers, transmitter output power and propagation loss, we can consider the received signal power from the perceived antenna gain. G_i denotes the corresponding perceived antenna gain from $Beam_i$ at position $(0, 0)$. It can be seen that, at this position, there exist also G_j and G_k from $Beam_j$ and $Beam_k$. Interference occurs if these users share the same frequency (*i.e.* co-channel interference). The interference is cumulative in that the total interference at user i is the sum of the interferences from user j and k .

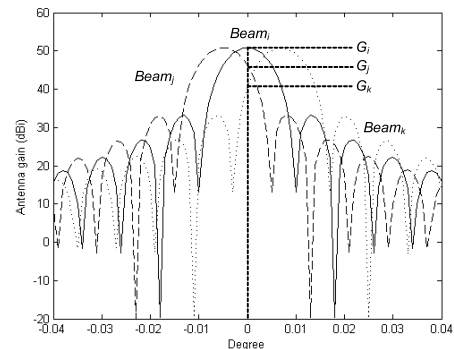

Figure 3: Cross sections of three satellite beams.

The SINR of a user i considers both interference and noise and is defined by $\left(\frac{C}{N+I}\right)_i^{-1} = A + \left(\frac{C}{N}\right)_i^{-1} +$

$(\frac{C}{T})_i^{-1}$ where A is a system constant,

$$\begin{aligned} (\frac{C}{N})_i &= \frac{(EiRP_{Term})_i / (RS)_i}{L_{Atmo} \cdot L_{DepTerm} \cdot L_{FSL}} \cdot \frac{G_{Sat(Beam_i \rightarrow i)}}{(T_A + T_{Rep}) \cdot k} \\ &= (K_1)_i \cdot \frac{G_{Sat(Beam_i \rightarrow i)}}{K_2} \end{aligned} \quad (1)$$

and

$$(\frac{C}{I})_i = \frac{(K_1)_i \cdot G_{Sat(Beam_i \rightarrow i)}}{\sum_{j \in Interf} (K_1)_j \cdot G_{Sat(Beam_j \rightarrow i)}}. \quad (2)$$

The terms K_1 and K_2 represent technical parameters which are the terminal's effective isotropic radiated power (EiRP_{Term}), the symbol rate (RS), the atmospheric loss (L_{Atmo}), the free space loss (L_{FSL}), the antenna equivalent temperature ($T_A + T_{Rep}$), and the Boltzmann constant (k).

$G_{Sat(Beam_i \rightarrow i)}$ and $G_{Sat(Beam_j \rightarrow i)}$ are user i 's antenna gain (regarding to its beam and position) and the interferer j 's antenna gain at user i 's position.

Let $B = (\frac{C}{N})_i^{-1}$ and $D = (\frac{C}{N})_{Required}$. The cumulative interference constraint for user i can be written in a linear form as

$$\sum_{j \in Interf} \delta_{ij} \leq \alpha_i \quad (3)$$

where $\delta_{ij} = D \cdot (K_1)_j \cdot G_{Sat(Beam_j \rightarrow i)}$ and $\alpha_i = (K_1)_i \cdot G_{Sat(Beam_i \rightarrow i)} \cdot (1 - AD - BD)$.

The term α_i can be perceived as an acceptable interference threshold for the user i while δ_{ij} as an interference coefficient from user j towards user i .

The technical constraints (Corbel 2010) involve superframe, frame and slot, frame structure constraints, beam positioning method, user priority, and modulation and coding scheme.

2.1 Superframe, frame and slot

A superframe is a logical structure composed of time in x-axis and frequency in y-axis. Its size is fixed by *FrameDuration* and *BWAvail*. The *BWAvail* represents the system bandwidth which consists of a number of equally spaced frequency channels (or frequency in short). A superframe houses a number of frames. All frames have the same time duration, equates *FrameDuration*, but can differ in frequency size. The frame size is fixed at any instant of *FrameDuration* but can be varied at a different instant. A frame is associated with a satellite beam and can be shared by a number of users. That frame can be varied in size both inside a superframe and over instant of *FrameDuration* allow it to accommodate different

user demands and mobility (start or stop services, add or remove users).

A user is allocated a slot inside a frame. Slots can be varied in both time and frequency in order to account for different user demands. A superframe thus accommodates a group of users that occupy segmentation of time and frequency. There is no overlapping of time-frequency resources among these users. More than one superframe can be created in order to accommodate more than one groups of users. In this sense, the frequency resource is reused. This frequency reuse could create interference among users sharing the same frequency at the same time.

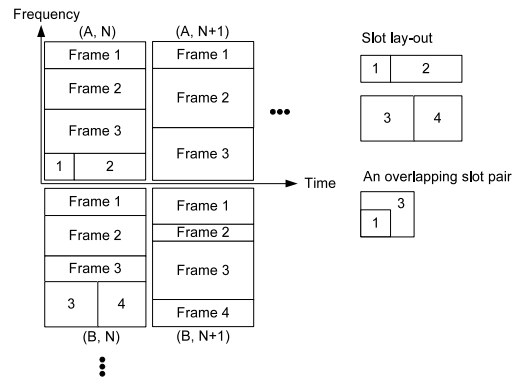

Figure 4: Superframe, frame, and slot.

Figure 4 shows an example of two superframes A and B at time instant N and $N + 1$. Frame 4 of superframe A consists of two slots: 1, 2; while Frame 4 of superframe B consists of two slots: 3, 4. There is no interference between Slot 1 and 2 and between Slot 3 and 4. But, as can be seen from the slot lay-out, interference occurs between the following slot pairs: 1-3, 2-3, 2-4. The pairs 1-3 and 2-3 contribute to cumulative interference in Slot 1.

The interference between a slot pair (or between a couple of users) can be either partial or full. Slot 1 is fully interfered by Slot 3 while Slot 3 is partially interfered by Slot 1. To represent this, we define another parameter r_{ij} as percentage of interference of user j to user i , ranging from 0 to 1, to the equation 3 as following:

$$\sum_{j \in Interf} r_{ij} \delta_{ij} \leq \alpha_i \quad (4)$$

2.2 Frame structure constraints

There are limitations on slot positioning inside the frame. A slot can have a number of consecutive frequencies and this consecutive frequency allocation should be conserved over the frame length, otherwise another slot that is allocated next to this slot should also use the same consecutive frequency allocation. In

other words, slicing the already allocated frequency chunk is not allowed within the same frame. A slot cannot be distributed among two frequency carriers inside the frame and the allocation should be continuous, see figure 5 for more information.

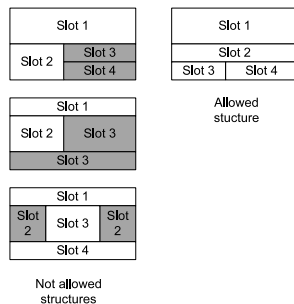

Figure 5: Frame structure constraints.

2.3 Beam positioning method

SDMA technology enables the satellite to generate a number of beams and position them at will. Refer to figure 2, a beam is circular and can be modeled as a circle or, as known as, a spot. Several spots can be positioned next to each other forming a regular 2-dimensional pattern covering the service area. This beam positioning method is called fixed beam.

The beams can be adaptive and centered at the users to provide each of them the maximum antenna gain. This beam positioning method is called centered beam.

As stated previously that a frame is associated with a beam; thus, a beam can accommodate one or more users.

2.4 User terminal type, user priority, and user guarantee

User's demand is treated in form of bitrate (Mbps). A user can requested for any bitrate demand but with a limitation based on the terminal type. Two terminal types are employed: Terminal Type 1 and Terminal Type 2. Type 1 supports up to 24 Mbps of data transfer (i.e. demand) while Type 2 supports up to 12 Mbps.

A user is also associated with a priority type. Four different priority levels are provided, from 0 (the highest) to 3 (the lowest). These priority levels should be considered during the resource allocation in that the user with higher priority should be taken care before the one with lower priority. To avoid the case that the lowest priority users are left unattended, the Weighted Round-Robin algorithm is applied. The algorithm first selects 4 users of Priority 0, then 3 users of Priority 1, 2 users of Priority 2, and 1 user of Priority 3. After this, the selection starts again from

Priority 0.

User guarantee provide options to the algorithm whether to allocate resource to the user or not in case that the bitrate demand requested by the user cannot be satisfied, and that a lower bitrate is considered. If case of guarantee, lower bitrate is not considered.

2.5 Modulation and coding scheme (RsMod-Cod)

To establish a communication link, not only does the user allocated time and frequency but also modulation and coding scheme. In fact, it is this modulation and coding scheme that determine the bandwidth requirement in MHz in which the allocation algorithm should assign time and frequency resources to match. For each Terminal Type, 64 combinations of modulation and coding scheme are provided, of which the selection is based on the user bitrate request and the estimated connection quality, the $\left(\frac{C}{N+I}\right)_{Estimated}$.

2.6 Power control

Power control feature is employed in order to reduce the overall interference in the system. At the connection setup, the user terminal contacts the system using its maximum output power, after the user allocation, the user terminal's transmitted power is evaluated if it can be reduced without impact to the communication link. This reduction is done in conjunction with a predefined power margin.

3 GREEDY ALGORITHMS

The greedy algorithm is proposed as of its simplicity, can be tailored according to the given specifications and is fast. The drawback of the algorithm lies on no-look-back concept in that the already allocated users or rejected users will not be re-allocated again. In this study, we are trying to allocate each user to a slot, a frame, and a superframe. Slot, frame, and superframe are defined by an allocation of time and frequency.

Two greedy algorithms are proposed i.e. Minimum Interference (MI) and Minimum Bandwidth (MB). Both share the same core but differ in the priority of the search for available slots in that MB provides more possibility of utilizing lower bandwidth.

Input to the algorithm is a user profile consisting of a number of users with randomly generated demand, priority, terminal type, traffic type, and coordinates. These users are ranked first by their priority levels. From this ranked list, a user is then selected based on Weighted Round-Robin algorithm.

Before entering the allocation phase, each of the se-

lected users will be assigned with an RsModCod. An RsModCod is a combination of symbol rate, modulation and coding scheme and is determined based on the user terminal type (1 or 2), bitrate demand, and the given estimated signal to noise plus interference ratio. Note that a user might not get an RsModCod if there is no valid RsModCod corresponding to the demand. In this case, no further allocation is done.

For an RsModCod, the corresponding required signal to noise ratio and the required user bandwidth are provided. The former will be used for calculating the user's acceptable interference threshold (α) and interference coefficients towards other users (δ). The latter will determine a set of valid combinations of slot size ($time \times frequency$) for the allocation.

Of all the user's valid combinations of slot size, the one with lower bandwidth requirement is chosen first for the allocation. A slot is tested in available positions (x_1, y_1 and x_2, y_2) of a superframe in which the X-axis represents time and Y-axis frequency. If there is no space left in a given superframe, a new superframe is created and tested.

No overlapping both in time and frequency between slots is allowed within the same superframe; nonetheless, overlapping either in time or frequency or both could exist between users from different superframes. In this case, an interference between overlapping slots (or users) present. Interference between two users is mutual and the level of interference is depended on how large the overlapping area is. A user can get interference from more than one user and interference level adds up. This cumulative interference should not exceed the user's acceptable interference threshold.

Not all of the available positions are tested. Five controlling variables are introduced to limit the search space. *SpecificS* provides the number of the one and only superframe used for the test and is applied for users served by the same satellite beams. *CapacityS* checks for the remaining capacity of a tested superframe if it can support the user with such a demand. *YLevel* acts like a water level in that the test starts from this level, no need to begin from the bottom of the superframe. *OverlapOwnS* determines if there is an overlapping between the test position and the already allocated position in the superframe. *LastS* provides the updated of the lastly used superframe and the test is performed at up to $LastS + 1$.

Two allocation policies are possible: Minimum Interference and Minimum Bandwidth. In Minimum Interference, for each user, the slot combination and slot position that yields lowest interference is selected. Minimum Bandwidth also utilizes minimum interference concepts but instead of moving up in frequency, it searches first for an unallocated area in another

superframe at the same frequency.

Algorithm flow charts are provided in figure 6 to 8 at the end of the paper.

3.1 Allocation cases

Three possible allocation cases are provided. The first case concerns user allocation to 40 grid-like fixed and uniformly distributed satellite beams. In this case, the users are assigned to the closest beam. Depending on the user's position, none, one or more users could be assigned to a beam. Users within the same beam will only be allocated to the same superframe, to the same or different frames while one or more beams could be allocated to a superframe. There is no interference among users within the same superframe.

The allocation is performed one-by-one following an order based on Weighted Round-Robin (WRR) algorithm. For each user allocation, both RsModCod selection and α and δ calculation are performed.

For each of the allocation success, the bandwidth check is performed. This will ensure that the overall allocated bandwidth will not exceed the maximum system bandwidth ($BWMax$).

The second case concerns user allocation with a satellite beam centered at each user and hence yielding maximum antenna gain. Since each user has its own beam, users cannot share the same frame; nonetheless they can still share the same superframe. The allocation handling is similar to that in the first case.

In the third case, beam-centered is used but with limited number of satellite beams ($NbBeams < NbUsers$). A beam will be assigned to a user at the start of the allocation. If the allocation fails, the beam assignment will be purged and reassigned to the next user. The first $NbBeams$ assignment complete users will get different beams. The following users will be assigned to the beam which is the closest.

3.2 RsModCod selection

After a user is chosen for an allocation, an RsModCod should be selected. The selection is based on the terminal type and the demand. Upon the selection, the corresponding symbol rate, required C/N and bandwidth will be used for α and δ calculation and the allocation.

The RsModCod that requires the lowest symbol rate and lowest required C/N and has the estimated value of $C/(N + I)$ not less than the required C/N while providing bitrate greater than the demand is chosen.

If there is no RsModCod available and the user is of

type non-guaranteed; another valid RsModCod which supports lower demand than the requested one will be selected. And if there is no other lower demand RsModCod, the user will not get the RsModCod and no allocation will be performed.

For the user with guaranteed traffic, if the user cannot get the RsModCod that supports its demand, no allocation will be performed.

4 COMPUTATIONAL EXPERIMENTS

Greedy algorithms are coded in Matlab (MATLAB 2008). Simulations are performed using with four different test environments, each with 50 test instances. These four environments are Env. 1 (high demand), Env. 2 (low demand), Env. 3 (low bandwidth with fixed demand), Env. 4 (high bandwidth with fixed demand). The instances are shown in table 1 and 2 below.

Instance	User	Min	Max	Avg	BW
Env. 1	30	1	24	12.5	60
Env. 2	30	1	12	6.5	60
Env. 3	30	10	10	10	60
Env. 4	30	10	10	10	100

Table 1: Test instance characteristics for Terminal Type 1

Instance	User	Min	Max	Avg	BW
Env. 1	30	1	10	5.5	60
Env. 2	30	1	5	3	60
Env. 3	30	10	10	10	60
Env. 4	30	10	10	10	100

Table 2: Test instance characteristics for Terminal Type 2

The simulations are performed on an Intel Pentium4 3GHz machine with 1 GB RAM. Four indicators i.e. Allocation Time, Number of Rejected Users, Total Slack, and Frequency Utilization are compared and presented in the subsections below. The following abbreviations are used.

- MI: Minimum Interference algorithm
- MB: Minimum Bandwidth algorithm
- FB: Fixed Beams
- BCxx: Beam-centered with xx number of beams

4.1 Allocation time

The allocation time is the average runtime in seconds. The results are shown in table 3.

Beam-centered requires longer allocation time than fixed-beams configuration for both MI and MB. Low number of beams requires less allocation time.

With normal demand, MI takes about the same allocation time as MB. Nonetheless, with low demand, the former takes much longer. This indicates that the user demand impacts a lot on the algorithm performances.

High bandwidth requires longer time since there is more search space in each superframe.

Algorithm	Env. 1	Env. 2	Env. 3	Env. 4
MIFB	7.86	6.79	5.36	12.83
MIBC30	11.26	10.49	7.63	18.36
MIBC25	10.82	9.02	7.67	17.74
MBFB	8.07	2.73	6.67	11.61
MBBC30	10.97	4.70	8.52	17.66
MBBC25	10.45	3.36	8.29	18.03

Table 3: Average allocation time (seconds)

4.2 Number of rejected users

Rejected users are users that the algorithm fails to assign the resource. Results are shown in table 4.

It is not surprising that the number of rejected users depends largely on the demand or resource (bandwidth).

For Env. 2 (low demand), the results are highly satisfactory as only few users are rejected. The best method, for which less than 3 users are rejected in average, is the MI with beam centering and 30 beams (thus fully exploiting the SDMA technology). Surprisingly, the MB becomes the best choice for beam centering allocation when the number of beams reduces to 25. MB shows also a much better performance than MI when the beams are fixed. When demand is high (Env. 1) the MI algorithm uniformly performs better than the MB. However the number of rejected users dramatically increases to more than 35%. Comparison between Env. 3 and Env. 4 shows the high impact of the bandwidth availability when the demand is fixed to a high value. For these highly constrained scenarios the MI always performs better than the MB.

Algorithm	Env. 1	Env. 2	Env. 3	Env. 4
MIFB	13.48	6.64	18.08	12.36
MIBC30	12.42	2.56	17.30	10.94
MIBC25	12.42	4.68	17.30	10.94
MBFB	14.96	3.28	19.34	13.64
MBBC30	14.44	2.78	18.94	13.26
MBBC25	14.44	3.36	18.94	13.26

Table 4: Number of rejected users

4.3 Total interference gap

Interference gap for a user is initialized by its interference threshold (α). This gap is reduced when there

is interference from other users. Higher interference gap means lower interference. Total interference gap is the summation of interference gap of all allocated users. Results are shown in table 5.

MI gives higher total slack than MB; nonetheless the gap is wider in the low demand case. The fixed beam gives slightly better total slack than that of the beam-centered. Note that for beam-centered case, the allocation within the same frame is not possible.

Algorithm	Env. 1	Env. 2	Env. 3	Env. 4
MIFB	2.14	3.73	1.77	1.79
MIBC30	2.14	3.52	1.77	1.78
MIBC25	2.14	3.67	1.77	1.78
MBFB	1.94	2.46	1.53	1.41
MBBC30	1.96	2.37	1.51	1.37
MBBC25	1.96	2.41	1.51	1.37

Table 5: Total interference gap

4.4 Frequency utilization

A frequency is considered utilized if all or part of it is allocated to users. Total number of utilized frequency are counted and average over 50 instances. Results are shown in table 6.

In most cases, the MB requires lower number of frequency than MI. A contradicting result was found in a low demand case (MIFB vs. MBFB). This would come from frame and slot allocation constraints.

Algorithm	Env. 1	Env. 2	Env. 3	Env. 4
MIFB	165.10	140.90	160.00	244.80
MIBC30	179.70	166.10	173.60	264.60
MIBC25	179.70	154.20	173.60	264.60
MBFB	154.20	157.20	144.40	231.00
MBBC30	155.90	159.80	147.90	239.80
MBBC25	155.90	156.90	147.90	239.80

Table 6: Number of used frequency

5 CONCLUSION

Specifications and constraints provided by the industry render the resource allocation problem highly complex. This complexity and the fact that, in practice, allocation plans must be recomputed frequently to cope for user mobility yield classic optimization tool such as Integer Linear Programming impractical. Greedy algorithms have to be proposed for this problem. Two greedy algorithms are devised and tested.

When the user demand is reasonable, the proposed greedy algorithms obtain a user acceptance rate that has been judged as satisfactory by the industrial partner. However when the problem becomes highly constrained, especially when the demand increases and

when the available bandwidth is limited the performance dramatically decrease. Future work will focus on computing upper bounds on the number of accepted user to be able to estimate the possible performance gain for highly constrained environment. Then local search heuristics should be proposed to improve the greedy algorithm.

References

- Aardal, K. I., van Hoesel, C. P. M., Koster, A. M. C. A., Mannino, C. & Sassano, A. (2003). Models and solution techniques for the frequency assignment problem, *4OR: Quarterly Journal of the Belgian, French and Italian Operations Research Societies* **1**(4): 261–317.
- Corbel, E. (2010). Gestion de la ressources radio dans un système utilisant le sdma, *Technical report*, Thales Alenia Space.
- Giambene, G. (2007). *Resource management in satellite networks: optimization and cross-layer design*, Springer.
- Hale, W. K. (1980). Frequency assignment: Theory and applications, *Proceedings of the IEEE* **68**: 1497–1514.
- Houssin, L., Artigues, C. & Corbel, E. (2011). Frequency allocation problem in a sdma satellite communication system, *Computers and Industrial Engineering* **61**(2): 346–351.
- Leese, R. & Hurley, S. (2002). *Methods and algorithms for radio channel assignment*, Oxford lecture series in mathematics and its applications, Oxford University Press.
- Liberti, J. C. & Rappaport, T. S. (1999). *Smart Antennas for Wireless Communications: IS-95 and Third Generation CDMA Applications*, Prentice Hall PTR, Upper Saddle River, NJ, USA.
- Lodi, A., Martello, S. & Monaci, M. (2002). Two-dimensional packing problems: A survey, *European Journal of Operational Research* **141**(2): 241–252.
- MATLAB (2008). *version 7.7.0 (R2008b)*, The MathWorks Inc., Natick, Massachusetts.
- Roy, R. (1997). Spatial division multiple access technology and its application to wireless communication systems, *Vehicular Technology Conference, 1997 IEEE 47th*, Vol. 2, pp. 730–734 vol.2.
- Roy, R. (1998). An overview of smart antenna technology: the next wave in wireless communications, *Aerospace Conference, 1998. Proceedings., IEEE*, Vol. 3, pp. 339–345 vol.3.

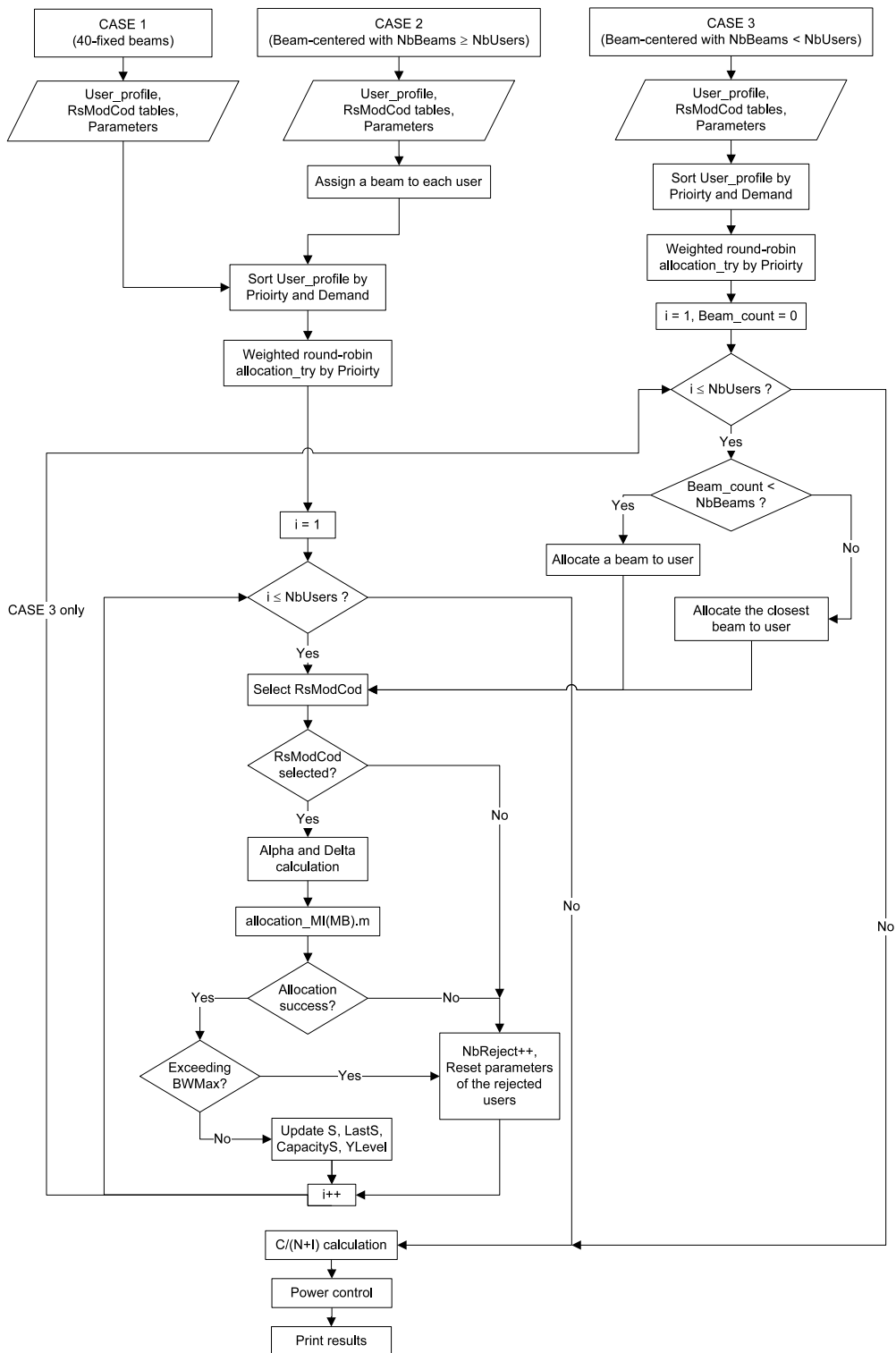
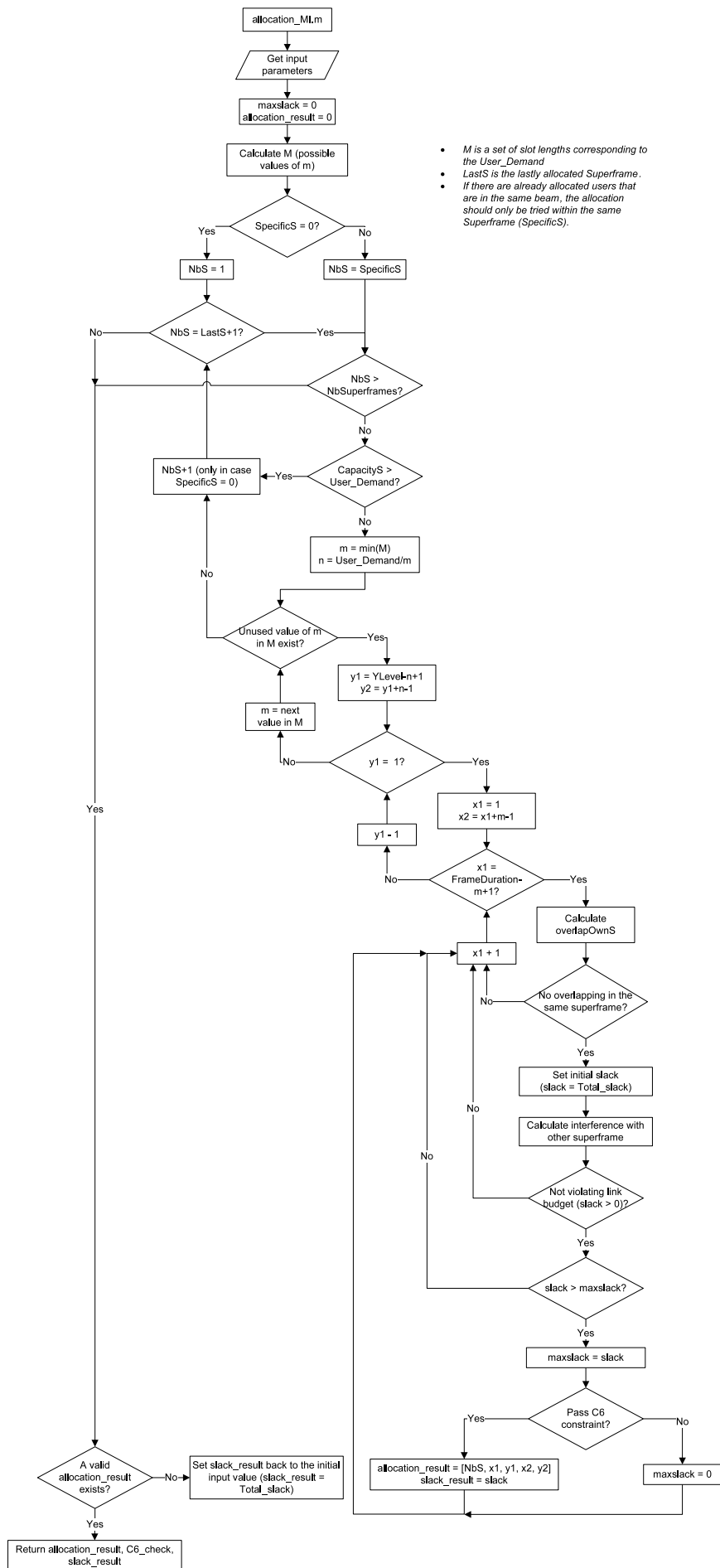

Figure 6: Greedy algorithm flow chart - allocation cases.



- M is a set of slot lengths corresponding to the $User_Demand$
- $LastS$ is the lastly allocated Superframe.
- If there are already allocated users that are in the same beam, the allocation should only be tried within the same Superframe (SpecificS).

Figure 7: Greedy algorithm flow chart - Minimum Interference.

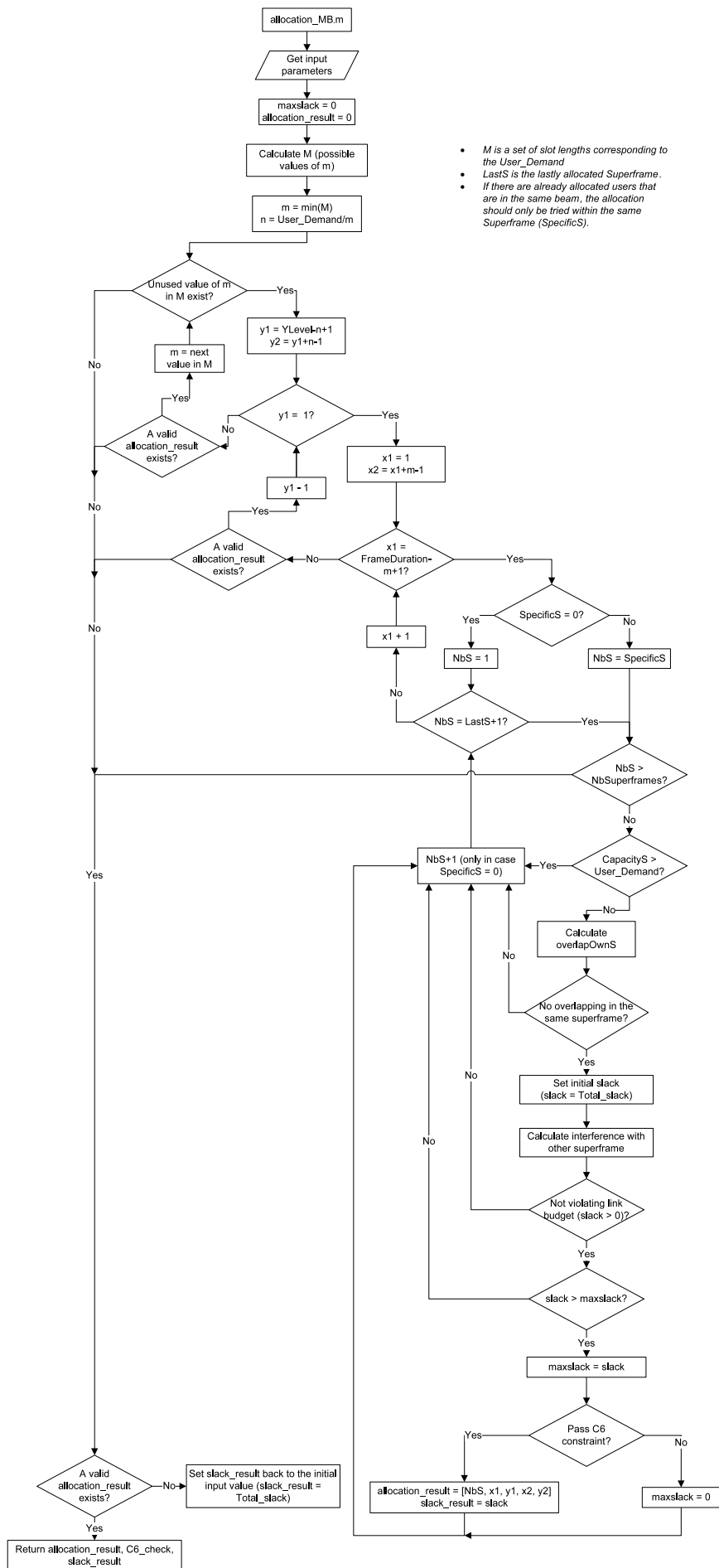

Figure 8: Greedy algorithm flow chart - Minimum Bandwidth.