



**HAL**  
open science

## Motorcycle Riding Simulator: How to Estimate Robustly the Rider's Action?

Lamri Nehaoua, Hichem Arioui, Said Mammar

► **To cite this version:**

Lamri Nehaoua, Hichem Arioui, Said Mammar. Motorcycle Riding Simulator: How to Estimate Robustly the Rider's Action?. IEEE Transactions on Vehicular Technology, 2013, pp.80-88. 10.1109/TVT.2012.2215052 . hal-00725426

**HAL Id: hal-00725426**

**<https://hal.science/hal-00725426>**

Submitted on 26 Aug 2012

**HAL** is a multi-disciplinary open access archive for the deposit and dissemination of scientific research documents, whether they are published or not. The documents may come from teaching and research institutions in France or abroad, or from public or private research centers.

L'archive ouverte pluridisciplinaire **HAL**, est destinée au dépôt et à la diffusion de documents scientifiques de niveau recherche, publiés ou non, émanant des établissements d'enseignement et de recherche français ou étrangers, des laboratoires publics ou privés.

# Motorcycle Riding Simulator: How to Estimate Robustly the Rider's Action?

Lamri Nehaoua, Hichem Arioui and Said Mammar

## Abstract

This paper deals with a motorcycle riding simulator and addresses two key issues: 1) reconstruction of rider's action, considered as the main input to the simulation system and 2) design an appropriate force feedback, on the handlebar, emulating a tire-road contact.

To answer the first challenge, a Walcott-Zak based sliding-mode observer is designed for the rider torque estimation. The reconstructed torque is used as the main control of the virtual motorcycle dynamic model, in order to actuate the simulator's platform. The steering system is modeled as a haptic display subjected to a couple of action-reaction torques: rider and tire-road dynamics.

Besides, a torque feedback is implemented to compensate the lack of the real tire-road contact. The control approach is based on a robust tracking problem of a reference steering angle by using  $\mathcal{H}_\infty$  optimization technique.

## I. INTRODUCTION

Motorcycle riders are considered as the most vulnerable and risky road users. Indeed, the incidence of motorcycle fatalities is still increasing, during last decades. In spite of the preventive measurements, as well as, recently repressive installations (radar enforcement of speed limit) and laws, the number of motorcyclists killed did not drop whereas considerable progresses in term of security (passive and active one) system were observed for the others car categories.

Passive and active security systems, such as ABS, ESP, safety belts and airbags, represent a major advance in term of driver safety. Most new cars are endowed with these safety systems that begin to emerge on two-wheeled vehicles. If it is clear that these security systems have a

L. Nehaoua, H. Arioui, and S. Mammar are with the IBISC Laboratory (EA-4526) of Evry Val d'Essonne University, 40, Rue du Pelvoux, 91020 Evry, France

proven efficiency, no information or studies exist about their real exploitation by the road users (riders and drivers). Consequently, the well control of assistance systems necessarily passes by users' knowledge and training. Moreover, number of accidents is a direct consequence of the lack of knowledge about risks incurred in some riding situations. Thus, it appears leading to develop a training/simulation tool.

Nowadays, driving simulators seem to be a perfect tool to answer crucial challenges such as: training of new drivers, risk awareness, road safety, etc. Their use becomes fundamental thanks to the possibility of carrying out representative experiments under reconfigurable conditions and scenarios (weather, infrastructure: urban/highway, etc.) Nevertheless, designing a simulator requires to make compromises between the quality of the reproduced motions and the overall cost of the mechatronics architecture. If designing a vehicle simulator is a very active research field since several years [1], [2], [3], the simulation of motorcycle riding remains stammering with few prototypes in the world [4], [5], [6]. The question of the immersion (the quality of the reproduced motions) is even more complex for a two-wheeled vehicle as well as of the balance (lean motion).

Generally, a driving simulator is built-up around two main components: a mechanical architecture and simulation software. This later consists of several computer units including the visual and the traffic environment generator, the control of mechanical platform and the virtual vehicle represented by its dynamic model. The vehicle dynamic model allows the computation of the vehicle states according to the simulator's user actions to update the visual environment and to actuate the mechanical platform. Consequently, the vehicle dynamic model is one of the most important components of a driving simulator.

To simulate a dynamic model, the vehicle steering angle is commonly used in automotive analysis and control. This fact makes possible to simulate the vehicle dynamics without any knowledge of the driver torque applied on the steering-wheel. Indeed, the driver's torque and the corresponding steering angle can be modeled by a minimal phase transfer function even by a simple proportional factor [7] because of the vehicle chassis and the steering system dynamics are completely decoupled. However, this assumption cannot be transcribed for two-wheeled vehicles for many reasons such: counter-steer phenomena, direct link between steering system and the front wheel and the effect of the roll motion. Hence, the motorcycle is primarily controlled by the applied rider's steering torque. Consequently, if the torque sensor is not available (cost

reason), an estimation procedure must be carried out to reconstruct this input. To the author's knowledge, contributions of this work have never been addressed before.

The problem of designing observers for linear systems with unknown inputs has been extensively studied in the literature [8], [9]. Among them, the sliding mode observers have been used for their robustness, insensitivity to the matched unknown inputs and finite/exact time convergence [10]. To construct such observer, two necessary and sufficient conditions should be satisfied: 1) the plant model must be a minimal phase system and 2) the so-called observer matching condition must be satisfied. However, the second condition is not guaranteed for a large range of mechanical systems. In this way, a great effort is invested to deal with the observer matching condition limitation and sliding mode observers have been extended to a large wide of physical systems [11]. In [12], additional output signals are generated from the measured outputs by using sliding mode differentiator, and the resulting augmented system satisfies well the observer matching condition.

In this paper, we discuss the possibility of using unknown input sliding mode observer for the estimation of the rider's torque applied on the simulator's handlebar. Since the system does not satisfy the observer matching condition, additional outputs are generated using high order sliding mode exact differentiator.

This paper is organized as follows: section II is dedicated to the simulator and the torque feedback system description. Also, in this section the identification process of the steering system used as the new interface between the rider and the virtual vehicle is presented. Section III highlights the design procedure of the rider's torque estimation. Section (IV) deals with the torque feedback control approach. Finally, results, conclusion and appendixes complete the paper.

## II. RIDING SIMULATOR AND TORQUE FEEDBACK SYSTEM

### A. *Motorcycle riding simulator*

Within the framework of the French SIMACOM research project (2005-2009), a riding motorcycle simulator is the result of a collaboration between the INRETS<sup>1</sup> and IBISC<sup>2</sup>-UEVE<sup>3</sup> laboratories in France.

<sup>1</sup>Institut National de la Recherche sur les Transports et leurs Sécurité

<sup>2</sup>Laboratoire d'Informatique, Biologie Intégrative et Systèmes Complexes

<sup>3</sup>Université d'Evry-Val d'Essonne



Fig. 1. SIMACOM's Riding Simulator Platform (INRETS-UEVE)

Despite its simplicity, this simulator is intended to reproduce, as possible as, inertial effects close to real riding cases. The SIMACOM simulator has been developed for two purposes (other possible changes are expected):

- as a training tool for new riders with different scenarios: normal traffic environment, dangerous riding situations (avoidance, emergency braking, nearly failing or slipping situations, etc.)
- to carry out riders behaviors studies in such situations.

First investigations have led to 5 degrees of freedom (DoF) mechanical platform including a double haptic feedback on the handlebar and three basic motions which consist of pitch, roll and yaw rotations.

Figure (1) presents a picture of the achieved riding simulator. More details concerning the mechatronics aspects can be found in [13], [6].

## B. Two-wheeled vehicle dynamics

In order to actuate the simulator's platform a vehicle dynamic model must be introduced. This model aims to predict the behavior of a virtual motorcycle according to rider's actions on the platform.

Many works have been addressed the modeling of single track vehicles. The first study, reported by Whipple, goes back to 1899 and relates to the bicycle's stability and balance [14]. In 1971, a reference study was undertaken by Sharp [15]. It examined the motorcycle's stability and its sensitivity to the variations of the geometrical and tire's parameters. More recently, the team of Cossalter at the University of Padova (Italy) has been invested for a several years on the development and the experimental validation of dynamic models intended for competition motorbike. The FastBike project presents a nonlinear model of the two-wheeled vehicle described as a set of 6 bodies, allowing the simulation of 11 DoF [16].

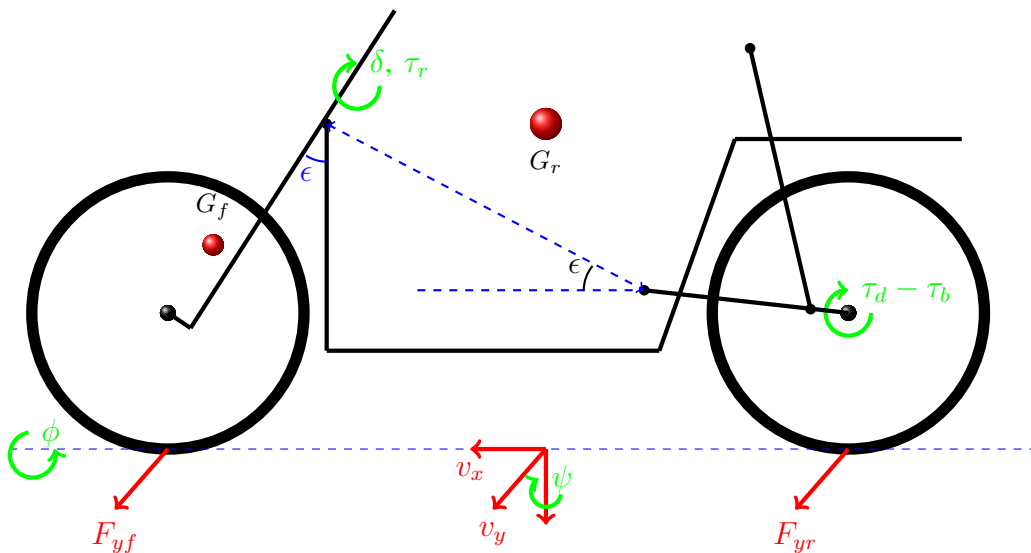

Fig. 2. Geometrical representation of the Sharp's motorcycle model

In general, two dynamical characteristics are considered: in-plane and out-of-plane modes. In-plane mode includes longitudinal, vertical and pitch motions whereas the out-of-plane mode represents lateral, yaw, roll and steer motions.

In the present paper, the out-of-plane dynamics is described by Sharp's 1971 model. The motorcycle is represented as a set of two rigid bodies linked through a steering mechanism

(Figure 2). The first body  $G_f$  is the front solid composed by the front wheel, the fork and the handlebar display. The second body  $G_r$  is the rear solid including the rear wheel, the engine, the tank and the seat. Here, the rider is supposed to be rigidly attached to the rear body frame and his relative motion is not taken into account. Equations of motion are expressed by the following state-space representation:

$$\dot{x}_v = \mathcal{A}_v x_v + \mathcal{B}_v \tau_r \quad (1)$$

where  $x_v = [v_y, \dot{\psi}, \dot{\varphi}, \dot{\delta}, \varphi, \delta, F_{yr}, F_{yf}]^T$  is the state vector and  $\tau_r$  is the rider torque applied on the handlebar. Matrices  $\mathcal{A}_v$  and  $\mathcal{B}_v$  are variables and function of the longitudinal velocity  $v_x$ , which is governed by :

$$\dot{v}_x = \frac{1}{m_e} \frac{\tau_d - \tau_b}{r_D} + m \dot{\psi} v_y + F_{wx} \quad (2)$$

*Remark 2.1:* See the appendix for states and variables definitions.

### C. Steering system description and modeling

For this platform, the motorcycle front body dynamics, including the wheel and the fork system, is substituted by a DC motor. The new resulting configuration, handlebar and motor, is considered as a new “connection” between the rider and the “virtual” motorcycle (i.e. dynamic model). Then, the DC motor ensures efforts feedback resulting from the road-tire interaction to the rider. At the same time, this device performs a significant role in estimating the action of the rider.

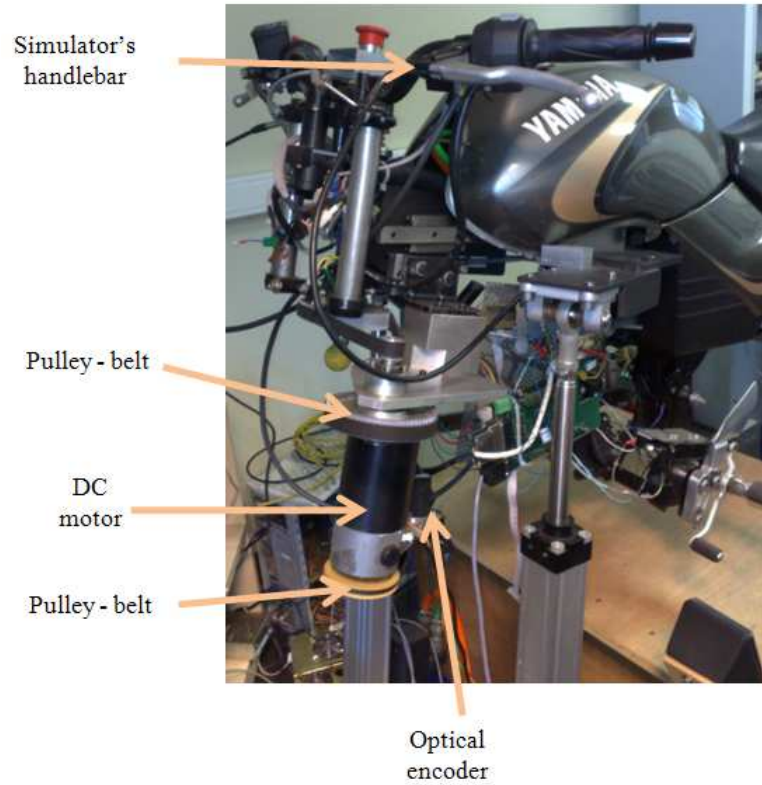

Fig. 3. Steering system of the riding simulator

The implemented new display includes several parts (Figure 3), described as:

- an original handlebar of a Yamaha 125 cm<sup>3</sup> motorcycle.
- the handlebar is attached to the DC motor axis through a double pulley-belt to increase the produced torque.
- an optical encoder for the measurement of the steer angle. This sensor is mounted in parallel axes through a pulley-belt system with respect to the DC motor shaft axis to improve the resolution of the rotation measure.

Since the electrical dynamics of the DC motor is very fast comparing to the mechanical one, it will be not considered below. Then, the equation describing the mechanical behavior of the DC motor is given by:

$$J_m \ddot{\theta}_m + \beta_{v,m} \dot{\theta}_m = \tau_m - \tau_{cm} \quad (3)$$

where,  $\theta_m$  is the rotor axis rotation,  $\tau_m$  is the delivered motor torque and  $\tau_{cm}$  is the load



torque. Moreover, the dynamics of the handlebar system can be expressed by:

$$J_h \ddot{\theta}_h + \beta_{v,h} \dot{\theta}_h + \beta_s \text{sign}(\dot{\theta}_h) = \tau_r + N \tau_{cm} \quad (4)$$

Where  $\theta_h$  is the handlebar steer angle and  $\tau_r$  is the rider's torque applied on the handlebar. Knowing that  $\theta_m = N \theta_h$  and  $\tau_m = k_t i$ , it results that:

$$J_{eq} \ddot{\theta}_h + \beta_{eq} \dot{\theta}_h + \beta_s \text{sign}(\dot{\theta}_h) = \tau_r + N k_t i \quad (5)$$

with:

$$\begin{aligned} J_{eq} &= J_h + N^2 J_m \\ \beta_{eq} &= \beta_{v,h} + N^2 \beta_{v,m} \end{aligned}$$

Equation (5) describes the dynamic behavior of the new rider-motorcycle interface.  $J_m$ ,  $\beta_{v,m}$ ,  $k_t$  and  $N$  are known parameters.

*Remark 2.2:* When modeling a DC motor, the electrical dynamics is considered as follows:

$$L \frac{di}{dt} + R i = u - k_e \dot{\theta}_h \quad (6)$$

where  $L$  and  $R$  are the motor's armature induction and resistance,  $k_e$  is the motor's voltage constant. Nevertheless, since the motor's armature induction is very low, the current dynamics  $di/dt$  is neglected, and it is supposed that the motor is driven by the current signal  $i$ . So, the transformation of current signal to an equivalent voltage signal is given by:

$$u = R i + k_e \dot{\theta}_h \quad (7)$$

#### D. Parametric Identification

Identification of the simulator's handlebar parameters is of crucial importance. In fact, misidentification of inertial parameters leads to a lack in state observation and control laws with degraded performances. In this section, we aim to estimate the handlebar's inertia  $J_h$  and friction parameters  $\beta_{v,h}$  and  $\beta_s$ . In the considered identification process, the DC motor is driven by a voltage signal in open-loop (without state feedback) and the rider torque is set to zero ( $\tau_r=0$ ). In

this case, only the motor current  $i$  and position angle  $\theta_h$  are measured while the angular velocity  $\dot{\theta}_h$  is obtained by differentiation.

First, equation (5) must be rewritten in a linear form with respect to parameters to be estimated such as:

$$\Phi\bar{p} = Nk_t i \quad (8)$$

where  $\bar{p} = [J_{eq}, \beta_{eq}, \beta_s]^T$  is the vector containing all parameters to be identified and  $\Phi = [\ddot{\theta}_h, \dot{\theta}_h, \text{sign}(\dot{\theta}_h)]$ .

Several methods were developed in the literature for the parametric identification [17], [18]. We choose the adaptive gradient method because of its simplicity in off-line or on-line implementation [19]. This method consists of optimizing a quadratic cost function  $C_f = \frac{1}{2}(\tau_{ref} - \tau)^2$ , where  $\tau_{ref} = Nk_t i$  and  $\tau = \Phi\bar{p}$ . Adaptation law is governed by:

$$\dot{\bar{p}} = -\mathcal{K}\Phi^T (Nk_t i - \Phi\bar{p}) \quad (9)$$

where  $\mathcal{K}$  is the adaptation matrix coefficients adjusted to ensure rapid convergence and also tied to the different excitation trajectories (slow or rapid reference trajectories). Finally, the different parameters are obtained by integrating  $\dot{\bar{p}}$  (equation 9).

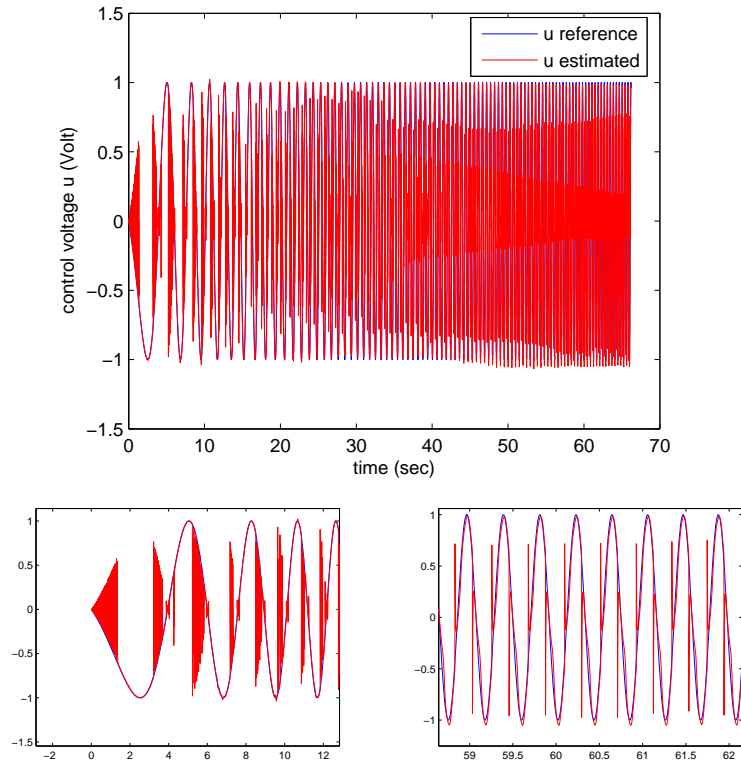

Fig. 4. Applied control voltage (a chirp sine 0.1-4Hz)

Experimental identification is carried out in open-loop using a voltage input signal of chirp sine type with a frequency interval of [0.1Hz-2Hz] and amplitude of 3 Volt. The angular position is recovered by CAN bus at a sampling rate of 100Hz. Identified parameters are summarized in table I.

inertia $J_h$	dry friction $\beta_s$	viscous friction $\beta_{v,h}$
(kg.m <sup>2</sup> )	(N.m)	(N.s/m)
0.0415	1.734	13.956

TABLE I

FRICTION AND INERTIAL ESTIMATED PARAMETERS

In figures (4) and (5), a validation of the handlebar's model is performed based on the identified parameters (table I). A voltage signal inputs, type chirp sine with a frequency interval of [0.1Hz-

4Hz] and a bipolar rectangular signal, are used to actuate the handlebar torque feedback system. The resulting handlebar position  $\theta_h$  is then differentiated to get  $\dot{\theta}_h$ , the motor current is measured and with equation (7), the voltage signal  $u$  is reconstructed.

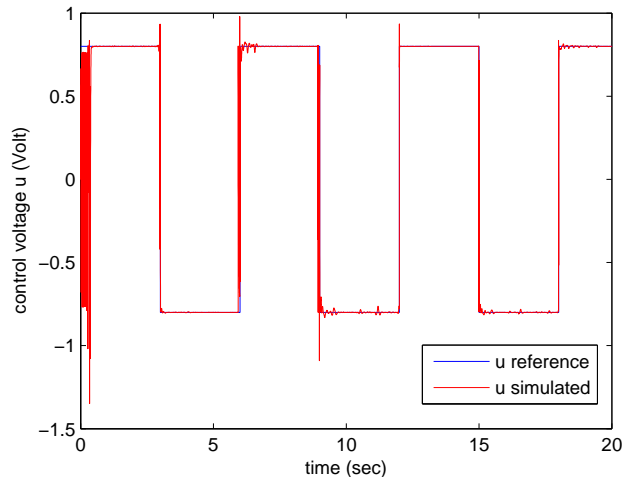

Fig. 5. Validation with a bipolar rectangular control voltage

### III. SLIDING MODE OBSERVER DESIGN FOR THE RIDER'S TORQUE ESTIMATION

In this section, we present the reconstruction of the rider's action based on sliding mode observer approach ([20]).

The state-space representation of the simulator's handlebar system is derived from equation (5) and can be expressed by:

$$\begin{aligned} \dot{x} &= \mathcal{A}x + \mathcal{B}u + \mathcal{D}(\tau_r + \tau_p) \\ y &= \theta_h = \mathcal{C}x \end{aligned} \quad (10)$$

where,  $x = [\dot{\theta}_h, \theta_h]^T$  is the state vector,  $u = k_t Ni$  is the control input,  $\tau_r$  is the unknown driver's torque to be estimated and  $\tau_p = -\beta_s \text{sign}(\dot{\theta}_h)$  is a known external bounded perturbation induced by the dry friction of the handlebar axis. In equation (10),  $\mathcal{D}$  is of full column rank and  $\mathcal{C}$  is of full row rank. The unknown input  $\tau_r$ , is obviously bounded, hence,  $\|\tau_r\| \leq \rho$  where  $\rho > 0$ .

Application of the sliding mode observer [20] to the system (10) yields to:

$$\dot{\hat{x}} = \mathcal{A}\hat{x} + \mathcal{B}u + \mathcal{L}(y - \hat{y}) - \mathcal{D}E(\hat{y}, y, \eta) \quad (11)$$

with  $\hat{y} = \mathcal{C}\hat{x}$  is the estimated output and:

$$E(\hat{y}, y, \eta) = \eta \frac{F(y - \hat{y})}{\|F(y - \hat{y})\|_2 + \epsilon} \quad (12)$$

is a nonlinear injection term where  $\epsilon$  is a small parameter used to reduce chattering and  $\eta$  is a design parameter.

The term  $\mathcal{L}(y - \hat{y})$  is used to improve the convergence of the observer. The existence of the observer gain  $\mathcal{L}$  is ensured by the observability/detectability of  $(\mathcal{A}, \mathcal{C})$  where  $\mathcal{L}$  is defined such that the matrix  $(\mathcal{A} - \mathcal{L}\mathcal{C})$  is Hurwitz and has a prescribed eigenvalues in the open left-half plane. In this case, for any  $\mathcal{Q}$  symmetric definite positive, there is a unique solution  $\mathcal{P}$  symmetric definite positive, such that:

$$(\mathcal{A} - \mathcal{L}\mathcal{C})^T \mathcal{P} + \mathcal{P}(\mathcal{A} - \mathcal{L}\mathcal{C}) + \mathcal{Q} = 0 \quad (13)$$

and  $\mathcal{P}$  satisfies, for some matrix  $\mathcal{F}$ , the following condition:

$$\mathcal{P}\mathcal{D} = \mathcal{C}^T \mathcal{F}^T \quad (14)$$

The previous observer is insensitive to the external perturbation if and only if the well-known matching condition  $\text{rank}(\mathcal{D}) = \text{rank}(\mathcal{C}\mathcal{D})$  is satisfied. However, for system (10), it is easy to check that  $\text{rank}(\mathcal{D}) \neq \text{rank}(\mathcal{C}\mathcal{D})$ , which means that the observer matching condition is not fulfilled. Nevertheless, according to [12], the sliding mode observer method can be extended for systems where the matching condition is not satisfied by generating additional output signals. For the present system, this means that we need the information of the motor's position rate (Figure 6). Consequently, the sliding mode observer (11) is re-defined as following:

$$\dot{\hat{x}} = \mathcal{A}\hat{x} + \mathcal{B}u + \mathcal{L}(y_a - \hat{y}_a) - \mathcal{D}E(\hat{y}_a, y_a, \eta) \quad (15)$$

where  $y_a = [\theta_h, \dot{\theta}_h]^T$  and  $\hat{y}_a = \mathcal{C}_a \hat{x}$ . The generated additional output  $\dot{\theta}_h$  is obtained by differentiating the measured position using a robust super-twisting exact differentiator [21].

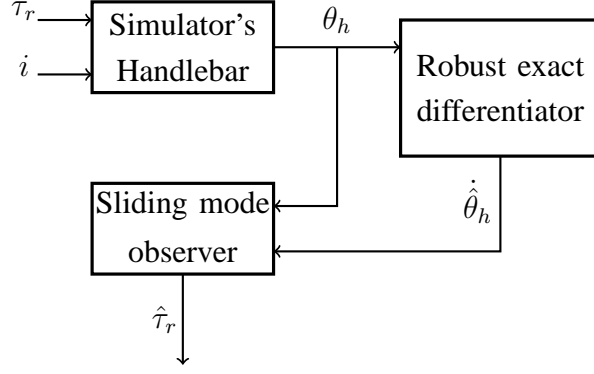

Fig. 6. Diagram of the unknown input sliding mode observer

As reported by Walcott and Zak, the error's dynamics of the observer is asymptotically stable for  $\eta \geq \rho$ . This means that after a finite time convergence of the differentiator, we have  $y_a = \mathcal{C}_a x$ . Thus, the observer's error can be defined by:

$$\dot{e} = (\mathcal{A} - \mathcal{L}\mathcal{C}_a)e + \mathcal{D}\tau_r + \mathcal{D}E(\hat{y}_a, y_a, \eta) \quad (16)$$

and after a finite time, the state estimation error  $e = x - \hat{x}$  converge to the sliding surface  $\{S : \mathcal{F}\mathcal{C}_a e = 0\}$ . According to equations 14 and 15, the unknown input is estimated by:

$$\mathcal{D}^T \mathcal{P} \mathcal{D} \{\tau_r + E(\hat{y}_a, y_a, \eta)\} = 0 \rightarrow \tau_r = -E(\hat{y}_a, y_a, \eta) \quad (17)$$

*Remark 3.1:* The main advantage of Walcott-Zak observer is its simplicity of use and well suited implementation especially for low order systems.

*Remark 3.2:* The main disadvantage of Walcott-Zak observer is the difficulty of finding a solution  $\mathcal{P}$  which satisfies simultaneously equations (13) and (14). For a low order system, the problem of finding the matrix  $\mathcal{P}$  can be done by hand calculation. Otherwise, a method proposed in [22] can be applied.

*Remark 3.3:* The driver's torque is, by definition, a bounded input. Here, we consider a torque's peak value about  $70N.m$ . Furthermore, a smooth approximation of  $\text{sign}(\cdot)$  by  $\tanh(\cdot)$  is assumed [23].

#### IV. TORQUE FEEDBACK CONTROL

The tire-road interaction and the gyroscopic effect generate a torque along the steering system. So, when driving a real motorcycle, a rider action is applied on the vehicle handlebar to counter the generated torque and hence drive the motorcycle toward an equilibrium trajectory.

On a riding simulator, the lack of tire-road interaction and gyroscopic effect makes the simulation of a given maneuver impossible. The visual environment information alone is not sufficient for a simulator's user to drive a virtual motorcycle, so, it is essential to implement a torque feedback (figure 7).

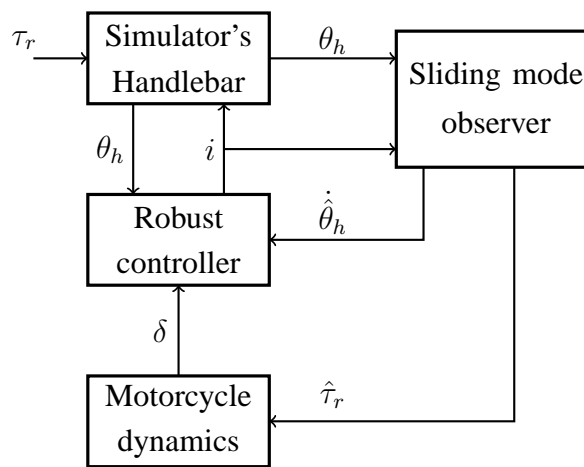

Fig. 7. Bloc diagram of the virtual motorcycle and the handlebar system

In this paper, the torque feedback is implemented as a robust tracking problem in order to follow a reference steering angle  $\delta$  generated by the motorcycle dynamic model. As shown in the figure 7, when a driver torque  $\tau_r$  is applied on the simulator's handlebar, it is immediately reconstructed by the unknown input observer. Afterward, the estimated torque  $\hat{\tau}_r$  is used as control input to the virtual motorcycle dynamic model. The robust controller is designed to bring the simulator's handlebar position  $\theta_h$  as closely as to its reference value  $\delta$  despite the driver action. Consequently, one can deduce that this control scheme is equivalent to a rider's torque rejection and from the motorcycle equilibrium it can be deduced that the torque delivered by the motor is the same as that generated by tire-road interaction, gyroscopic effects and other dynamic phenomenon.

This control approach is more efficient since it avoids recompiling the resulted torque (requiring rate and acceleration information) and also avoiding algebraic loops which may cause instabilities. Furthermore, high performances (in term of tracking) are not required since the objective is to reconstitute admissible torque and the rider adjusts his trajectory, according to the visual rendering, by applying more or less effort.

Reconsider the state-space representation of the simulator's handlebar system described by equation (10) as following:

$$\begin{aligned} \dot{x} &= \mathcal{A}x + \mathcal{B}i + \mathcal{D}w \\ y &= \theta_h = \mathcal{C}x \end{aligned} \quad (18)$$

where  $w = \tau_r + \tau_p$ . In transfer function representation, the system output is given by:

$$y = \theta_h = G_h i + G_w w \quad (19)$$

Under parameter uncertainties, the previous output are rewritten as following:

$$\theta_h = G_{h,\Delta} i + G_{w,\Delta} w \quad (20)$$

where,  $G_{h,\Delta}$ ,  $G_{w,\Delta}$  are the perturbed transfer functions. In the following, a feedback loop-shaping design procedure is adopted (Figure 8). In this procedure, the parameter uncertainties are represented as a perturbation on the normalized left coprime factor of the system model [24], [25]. Consequently, the perturbed plant  $G_{h,\Delta}$  is given by:

$$G_{h,\Delta} = (M - \Delta_M)^{-1} (N_h + \Delta_{N_h}) \quad (21)$$

$$G_{w,\Delta} = (M - \Delta_M)^{-1} N_w$$

where  $[M, N_h] \in \mathcal{H}_\infty$  are the left coprime factors,  $\Delta_M, \Delta_{N_h} \in \mathcal{H}_\infty$  are unknown modeling perturbations. By replacing (21) in (20), we obtain:

$$M\theta_h = N_h i + N_w w + \phi \quad (22)$$



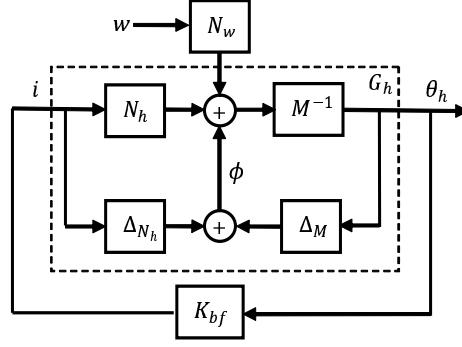

Fig. 8. Closed-loop system for the normalized coprime factor model

in which  $\phi = \Delta_{N_h} i + \Delta_M \theta_h$ . The aim here is to design a controller  $i = K \theta_h$  that stabilizes the closed-loop system against the external perturbation  $w$  and unstructured parameter uncertainties  $\phi$ . This is achieved by minimizing  $\mathcal{H}_\infty$  norm of the transfer  $T_{[\phi, w]^T \rightarrow [\theta, i]^T}$  such that:

$$\|T_{[\phi, w]^T \rightarrow [\theta, i]^T}\| < \gamma \quad (23)$$

where  $T_{[\phi, w] \rightarrow [\theta, i]}$  is given by:

$$T_{[\phi, w] \rightarrow [\theta, i]} = \begin{bmatrix} I \\ K \end{bmatrix} (I - G_h K)^{-1} \begin{bmatrix} M^{-1} & G_w \end{bmatrix} \quad (24)$$

Finally, finding  $K$  which minimizes  $\gamma$  such that  $\|T_{[\phi, w] \rightarrow [\theta, i]}\|_\infty < \gamma$  is equivalent to the problem of minimizing the four blocs  $\mathcal{H}_\infty$  one [26] given by:

$$T_{[\phi, w] \rightarrow [\theta, i]} = \begin{bmatrix} I \\ K \end{bmatrix} (I - G_s K)^{-1} \begin{bmatrix} I & G_s & G_w \end{bmatrix} \quad (25)$$

where,  $G_s = W_2 G_h W_1$  is the shaped version of  $G_h$ . By using Hifoo toolbox [27], an optimal  $\mathcal{H}_\infty$  reduced-order controller with performance level  $\gamma^* = 2.5587$  is obtained as the following:

$$K(s) = \frac{-2.355s - 613.7}{s + 1445} \quad (26)$$

## V. SIMULATION RESULTS AND EXPERIMENTAL TESTS

This part aims to point-out the effectiveness of the overall architecture of figure (7), including Walcott-Zak unknown input observer, exact differentiator and the robust torque feedback. We discuss the reconstruction of the applied rider's torque results and the disturbance rejection for the steering angle tracking.

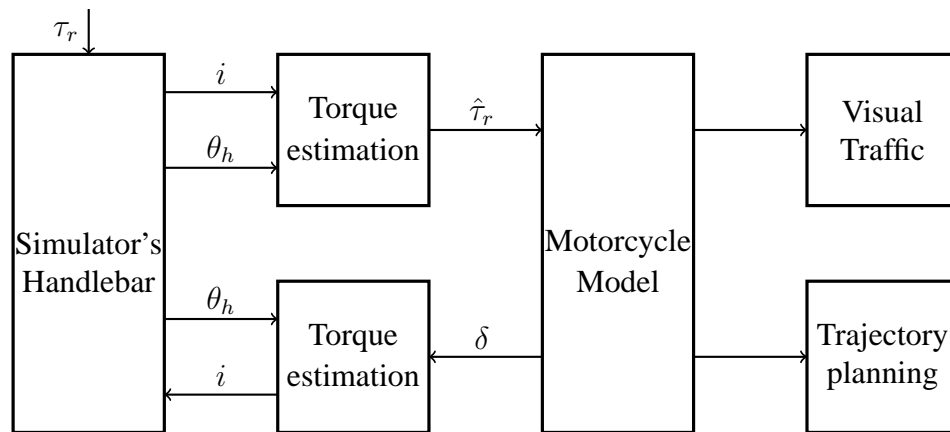

Fig. 9. Open-loop architecture of the riding simulator

### A. Simulation results

We consider here a square torque signal as depicted in (figure 10). This signal will be referred as the reference steering torque.

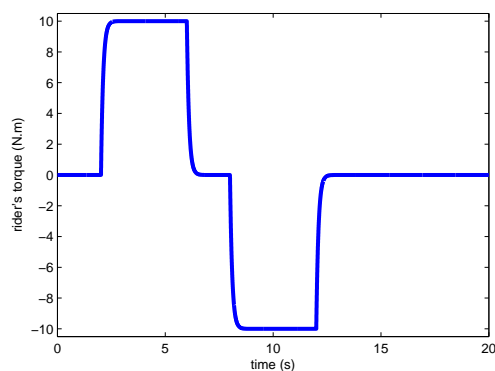

Fig. 10. Applied Rider's torque  $\tau_r$

In the first simulation, the dry friction effect is neglected. Moreover, the simulation is carried out for the nominal system and for an uncertainty of 50% on motor's parameters (inertia and viscous damping). Figure (11) illustrates the reference steering torque versus the estimated one by using the Walcott-Zak observer. One can conclude that the observer ensures an exact convergence, in a finite time, under noiseless signals existence for the nominal system and an asymptotic convergence for the perturbed plant.

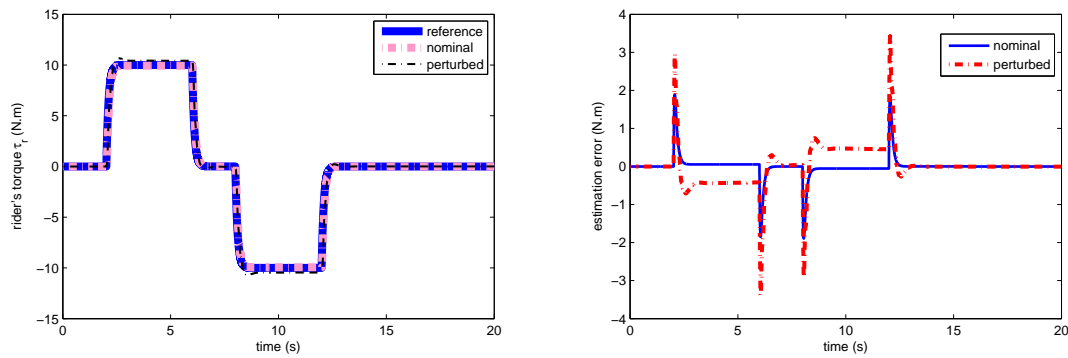

Fig. 11. Rider's torque estimation for the nominal and perturbed systems

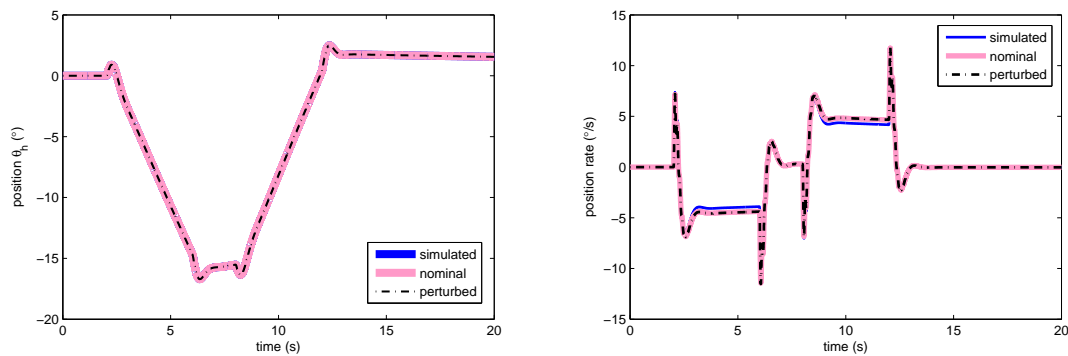

Fig. 12. Performance of Walcott-Zak observer for state estimation: (left) position and (right) velocity

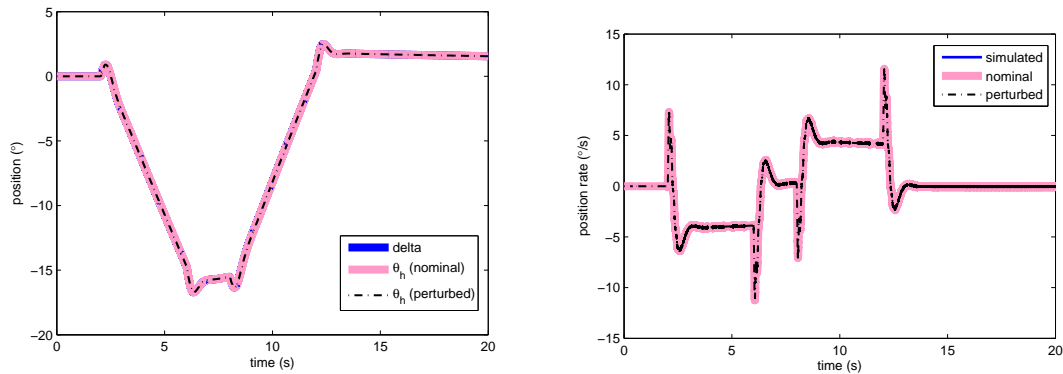

Fig. 13. (left) Performance of the robust controller, (right) Performance of the robust differentiator

Besides the unknown input estimation, the present observer can also estimate all system states (position and velocity). Figure (12) represents the simulated steering position and its rate using the handlebar model of equation (10) and the estimated ones. It can be shown that for state estimation, the used observer is robust against parameter uncertainties and ensures exact convergence in finite time but for noiseless signals.

Finally, figure (13) shows both performances of the robust controller and the robust differentiator. The proposed controller allows a robust tracking of a reference handlebar position  $\delta$  even in the presence of parameter uncertainties. The same remark can be stated for the differentiator, used to generate additional outputs in order to satisfy matching condition.

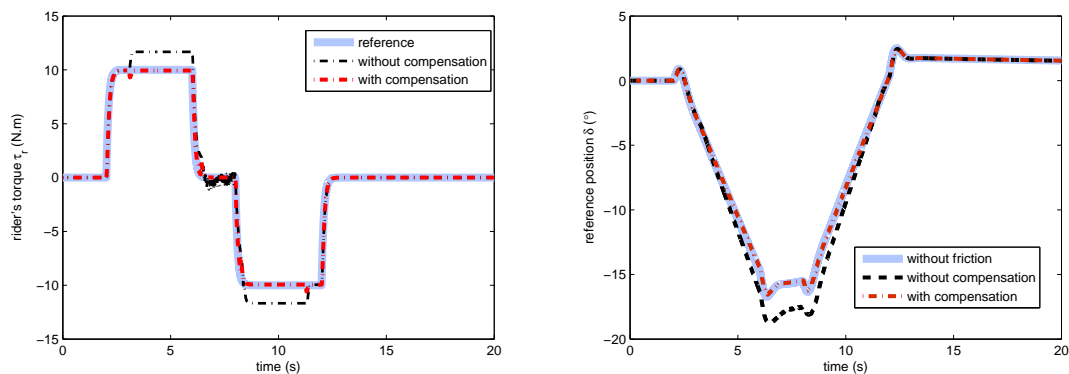

Fig. 14. Compensation of dry friction: (left) impact on rider's torque estimation, (right) impact on reference position generation

In the following simulation, the effect of dry friction is included. Figure (14) represents the

estimated rider's torque and the reference handlebar position as generated by the motorcycle model. In this figure, and according to equation 10, it can be shown that the estimated unknown input is the sum of the rider's torque  $\tau_r$  and the perturbation torque  $\tau_p$  induced by dry friction. Hence, a compensation of  $\tau_p$  is necessary to extract the torque information which will be used by the motorcycle model. Without compensation, the effect of dry friction may be undesirable especially under low motorcycle speed where the rider's torque to be applied is reduced.

*Remark 5.1:* It should be mentioned that the robust differentiator convergence is ensured for noiseless input signal. In the case of stochastic noisy signals, a filter must be introduced. Nevertheless, in experimentation, the measured position noise is very limited since this measurement is obtained from a digital encoder and acquired using CAN bus interface.

*Remark 5.2:* In experimentation, an undesirable rider's hand motion can be occurred even if the rider has no attention to manipulate the simulator's handlebar. This motion can generate a chattering induced by the  $\text{sign}(\dot{\theta}_h)$  function. To avoid this situation, a dead zone of a small width is introduced on the handlebar's velocity.

### B. Experimental tests

In this section, we present experiments carried out on the motorcycle riding simulator. According to the visual environment, the rider applies a torque to follow a defined trajectory. Only the handlebar position  $\theta_h$  and the motor current  $i$  are measured.

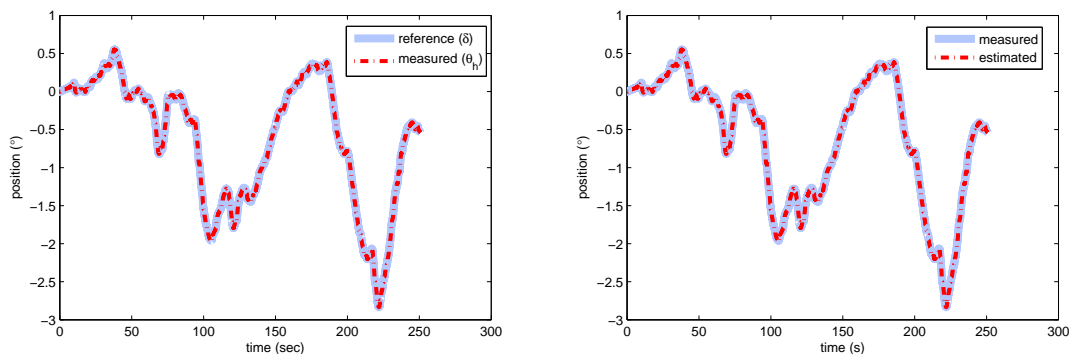

Fig. 15. Performances of the robust controller and state estimation

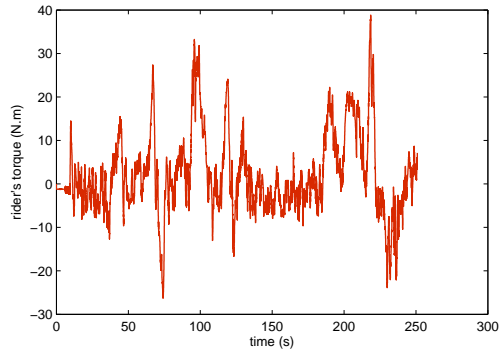

Fig. 16. Rider's torque estimation using Walcott-Zak observer

In figures (15,16), one can notice an exact estimation of the system states and an asymptotic convergence of the driver torque with compensation. It is also shown that the robust controller satisfies requirements on the position reference tracking. In figure (17), the position rate as obtained by the robust differentiator is reported. Finally, the effectiveness of the proposed torque feedback method is shown in figure (18) where the estimated rider's torque is compared to motor delivered torque computed from the measured current ( $\tau_m = k_t Ni$ ). The effectiveness of the proposed torque feedback method is shown in figure (18) where the estimated rider's torque is compared to motor delivered torque computed from the measured current ( $\tau_m = k_t Ni$ ).

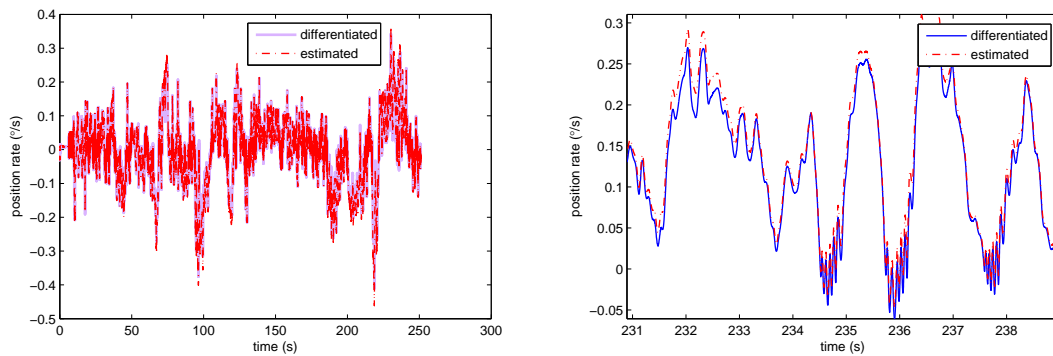

Fig. 17. Angular velocity  $\dot{\theta}_h$ : differentiated using exact robust differentiator and estimated using Walcott-Zak observer

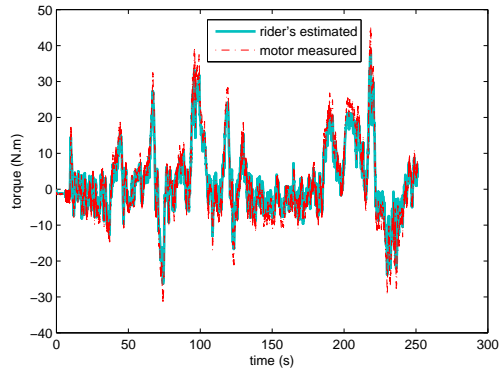

Fig. 18. Rider's torque estimation and the motor induced torque computed from the current measurement

## VI. CONCLUSION

The rider's actions on a driving simulator are considered to be the only physical inputs. The remaining inputs are reconstructed from the dynamic model of the bike. Some rider actions are measurable by through sensors, others are not (at least in our version of the simulator). One of these inputs is the rider's torque, essential to excite the dynamic model for operating at best platform.

The objective of this paper is precisely the reconstruction of unknown inputs, whose rider's torque. To this end, we implement a sliding-mode unknown input observer of Walcott-Zak type. This choice is motivated by the fact that this observer is quite simpler to use and achieves comparable results to other approaches in terms of robustness and convergence.

In this way, a new rider-simulator interface is designed. A DC motor is implemented on the handlebar torque feedback. The different mechanical parameters are identified and a robust approach, based on an optimal  $\mathcal{H}_\infty$  reduced-order controller, is developed for the feedback torque restitution.

Since, the handlebar plant does not satisfy the matching observer condition, additional outputs are generated by using a robust exact differentiator. It may be noted that, the use of a CAN bus is very useful to limit the influence of noises especially the current measurement one. The performance of the overall architecture is simulated and tested. For our current application (riding simulation), obtained results are very satisfactory especially when the dry friction is compensated.

## VII. APPENDIX

Motorcycle	(numerical values are well documented in reference [15])
$x, y, z$	longitudinal, lateral and vertical dynamics
$v_x, v_y$	longitudinal and lateral velocities
$\varphi, \theta, \psi$	roll, pitch and yaw rotations
$\delta$	steer angle
$m$	motorcycle mass
$J_R, r_D$	wheel spin inertia and dynamic radius
$m_e$	equivalent mass, $m_e = \left(m + \frac{J_R}{r_D^2}\right)^{-1}$
$\tau_r$	rider's torque
$\tau_d, \tau_b$	driving and braking forces
$F_{wx}$	wind gust
$F_{yr}, F_{yf}$	rear and front side slip force
$\mathcal{A}_v$	state matrix $\mathcal{A}_v = \mathcal{M}^{-1}\mathcal{E}$
$\mathcal{B}_v$	input matrix $\mathcal{B}_v = \mathcal{M}^{-1}[0, 0, 0, 1, 0, 0, 0]^T$
$\mathcal{M}$	motorcycle mass matrix
$\mathcal{E}$	motorcycle generalized effort vector
Handlebar system	
$\theta_m, \theta_h$	motor and handlebar rotations
$J_m, \beta_{v,m}$	inertia and damping of motor's rotor
$J_h, \beta_{v,h}, \beta_s$	inertia, damping and dry friction of handlebar
$N$	pulley transmission ratio
$\tau_m, i, k_t$	induced torque, current and torque factor of motor
$\mathcal{A}, \mathcal{B}, \mathcal{D}$	are respectively $\begin{bmatrix} -\frac{\beta_{eq}}{J_{eq}} & 0 \\ 1 & 0 \end{bmatrix}$ , $\begin{bmatrix} \frac{Nk_t}{J_{eq}} \\ 0 \end{bmatrix}$ , $\begin{bmatrix} \frac{1}{J_{eq}} \\ 0 \end{bmatrix}$
Notations	
$\dot{x}, \ddot{x}$	first and second derivative of a variable $x$ w.r.t time
$\hat{x}$	estimate of a variable $x$
$x^T$	transpose of vector or matrix $x$



$$\mathcal{M} = \begin{bmatrix} a_{11} & a_{12} & a_{13} & a_{14} & 0 & 0 & 0 & 0 \\ & a_{22} & a_{23} & a_{24} & 0 & 0 & 0 & 0 \\ & & a_{33} & a_{34} & 0 & 0 & 0 & 0 \\ & & & a_{44} & 0 & 0 & 0 & 0 \\ & \star & & & -1 & 0 & 0 & 0 \\ & & & & & -1 & 0 & 0 \\ & & & & & & 0 & \sigma_r \\ & & & & & & & \sigma_f \end{bmatrix}$$

$$\mathcal{E} = \begin{bmatrix} 0 & b_{12} & 0 & 0 & 0 & 0 & -1 & -1 \\ 0 & b_{22} & b_{23} & b_{24} & 0 & 0 & -b & -l \\ 0 & b_{32} & 0 & b_{34} & b_{35} & b_{36} & 0 & 0 \\ 0 & b_{42} & b_{43} & C_\delta & b_{45} & b_{46} & 0 & \eta \\ 0 & 0 & 1 & 0 & 0 & 0 & 0 & 0 \\ 0 & 0 & 0 & 1 & 0 & 0 & 0 & 0 \\ 0 & 0 & 0 & 0 & 0 & 0 & 0 & 0 \\ 0 & 0 & 0 & 0 & 0 & 0 & 0 & 0 \end{bmatrix}$$

---

Parameters  $a_{ij}$  (mass matrix  $\mathcal{M}$  is symmetric positive definite matrix)

---

$$a_{11} = m_f + m_r \quad a_{12} = m_f k \quad a_{13} = m_r h + m_f j \quad a_{14} = m_f e$$

$$a_{22} = m_f k^2 + I_{rz} + I_{fz} \cos^2 \epsilon + I_{fx} \sin^2 \epsilon$$

$$a_{23} = m_f k j - C_{rxz} + (I_{fz} - I_{fx}) \cos \epsilon \sin \epsilon$$

$$a_{24} = m_f e k + I_{fz} \cos \epsilon$$

$$a_{33} = m_r h^2 + m_f j^2 + I_{rx} + I_{fx} \cos^2 \epsilon + I_{fz} \sin^2 \epsilon$$

$$a_{34} = m_f e j + I_{fz} \sin \epsilon \quad a_{44} = m_f e^2 + I_{fz}$$

---

Parameters  $b_{ij}$

---

$$b_{12} = (m_f + m_r)v_x \quad b_{22} = m_f k v_x \quad b_{23} = -(i_{fy}/R_f + i_{Ry}/R_r)v_x$$

$$b_{24} = -i_{fy}/R_f \sin \epsilon v_x \quad b_{32} = (m_f j + m_r h + i_{fy}/R_f + i_{Ry}/R_r)v_x$$

$$b_{34} = i_{fy}/R_f \cos \epsilon v_x \quad b_{35} = -(m_f j + m_r h)g \quad b_{36} = Z_f \eta - m_f e g$$

$$b_{42} = (m_f e + i_{fy}/R_f \sin \epsilon)v_x \quad b_{43} = -i_{fy}/R_f \cos \epsilon v_x$$

$$b_{45} = Z_f \eta - m_f e g \quad b_{46} = (Z_f \eta - m_f e g) \sin \epsilon$$

---

## REFERENCES

- [1] L. Chen, Y. Papelis, G. Waston, and D. Solis, "NADS at the University of Iowa: A tool for driving safety research," in *Proceedings of 1st Human Centered Transportation Simulation Conference*, Iowa, USA, 2001.
- [2] L. Nehaoua, H. Mohellebi, A. Amouri, H. Arioui, S. Espié, and A. Kheddar, "Design and control of a small-clearance driving simulator," *IEEE Transactions on Vehicular Technology*, vol. 57, no. 1, pp. 736–746, 2008.
- [3] H. Arioui, S. Hima, L. Nehaoua, R. Bertin, and S. Espié, "From design to experiments of a 2-dof vehicle driving simulator," *IEEE Transactions on Vehicular Technology*, vol. 60, pp. 357–368, 2011.
- [4] Y. Miyamaru, G. Yamasaky, and K. Aoky, "Development of motorcycle riding simulator," *JSAE Review*, vol. 23, pp. 121–126, 2002.
- [5] V. Cossalter, A. Doria, and R. Lot, "Development and validation of a motorcycle riding simulator," in *World Automotive Congress FISITA*, Barcelona, Spain, 2004.
- [6] H. Arioui, L. Nehaoua, S. Hima, N. Ségué, and S. Espié, "Mechatronics, design, and modeling of a motorcycle riding simulator," *IEEE/ASME Transactions on Mechatronics*, vol. 15, no. 5, pp. 805–818, 2010.
- [7] C. Sentouh, P. Chevrel, F. Mars, and F. Claveau, "A human-centred approach of steering control modelling," in *21st IAVSD Symposium on Dynamics of Vehicles on Roads and Tracks*, Sweden, 2009.
- [8] M. Darouach, "On the novel approach to the design of unknown input observers," *IEEE Transactions on Automatic Control*, vol. 39, pp. 606–609, 1994.
- [9] D. Luenberger, "An introduction to observers," *IEEE Transactions on Automatic Control*, vol. 16, pp. 596–602, 1971.
- [10] K. Kalsi, J. Lian, S. Hui, and S. Zak, "sliding mode observers for systems with unknown inputs: a high-gain approach," *Automatica*, vol. 46, pp. 347–353, 2010.
- [11] T. Floquet and J. Barbot, "A canonical form for the design of unknown input sliding mode observers," *Advances in Variable Structure and Sliding Mode Control*, vol. 334, 2006.
- [12] T. Floquet, C. Edwards, and S. Spurgeon, "on sliding mode observers for systems with unknown inputs," *International Journal of Adaptive Control and Signal Processing*, vol. 21, pp. 638–656, 2007.
- [13] L. Nehaoua, H. Aroui, N. Ségué, and S. Espié, "Design and modeling of a new motorcycle riding simulator," *American Control Conference (ACC'07)*, pp. 176–181, 2007.
- [14] F. Whipple, "Stability of the motion of a bicycle," *Quarterly Journal of Pure and Applied Mathematics*, vol. 30, 1899.
- [15] R. Sharp, "The stability and control of motorcycles," *Journal of Mechanical Engineering Science*, vol. 13, pp. 316–329, 1971.
- [16] V. Cossalter and R. Lot, "A motorcycle multibody model for real time simulation based on the natural coordinates approach," *Vehicle System Dynamics*, vol. 37, no. 6, pp. 423–447, 2002.
- [17] I. Landau, *Identification et commande des systèmes*. Hermès-Science, 1993, ISBN-2-86601-365-4.
- [18] K. Aström and B. Wittenmark, *Adaptive control*. Dover Publications, 2008, ISBN-978-0201558661.
- [19] J. Craig, *Adaptive Control of Mechanical Manipulators*. Addison-Wesley Publishing Company, 1988, ISBN 0-201-10490-3.
- [20] B. Walcott and S. Zak, "Combined observer-controller synthesis for uncertain dynamical systems with applications," *IEEE Transactions on Systems, Man and Cybernetics*, vol. 18, pp. 88–104, 1988.
- [21] A. Levant, "Robust exact differentiation via sliding mode technique," *Automatica*, vol. 43, no. 3, pp. 379–384, 1998.
- [22] S. Hui and S. Zak, "Observer design for systems with unknown inputs," *International Journal of Applied Mathematics and Computer Science*, vol. 15, no. 4, pp. 431–446, 2005.

- [23] B. Yao and M. Tomizuka, "Robust adaptive nonlinear control with guaranteed transient performance," *Proceedings of the American Control Conference*, vol. 4, pp. 2500–2504, 1995.
- [24] K. Glover and D. McFarlane, "Robust stabilization of normalized coprime factor plant descriptions with  $\mathcal{H}_\infty$  bounded uncertainty," *IEEE Transactions on Automatic Control*, vol. 34, no. 8, pp. 821–830, 1989.
- [25] D. McFarlane and K. Glover, "A loop-shaping design procedure using  $\mathcal{H}_\infty$  synthesis," *IEEE Transactions on Automatic Control*, vol. 37, no. 6, pp. 759–769, 1992.
- [26] M. Green and D. Limebeer, *Linear Robust Control*. Prentice Hall, 1995, iISBN-13-978-0131022782.
- [27] S. Gumussoy, D. Henrion, M. Millstone, and M. Overton, "Multiobjective robust control with hifoo 2.0," *In Proceedings of 6th IFAC Symposium on Robust Control Design*, 2009.