



HAL
open science

**Cell biology of HO generation in the thyroid:
Investigation of the control of dual oxidases (DUOX)
activity in intact ex vivo thyroid tissue and cell lines.**

C. Massart, C. Hoste, A. Virion, J. Ruf, J.E. Dumont, J. van Sande

► **To cite this version:**

C. Massart, C. Hoste, A. Virion, J. Ruf, J.E. Dumont, et al.. Cell biology of HO generation in the thyroid: Investigation of the control of dual oxidases (DUOX) activity in intact ex vivo thyroid tissue and cell lines.. *Molecular and Cellular Endocrinology*, 2011, 343 (1-2), pp.32. 10.1016/j.mce.2011.05.047 . hal-00723609

HAL Id: hal-00723609

<https://hal.science/hal-00723609>

Submitted on 11 Aug 2012

HAL is a multi-disciplinary open access archive for the deposit and dissemination of scientific research documents, whether they are published or not. The documents may come from teaching and research institutions in France or abroad, or from public or private research centers.

L'archive ouverte pluridisciplinaire **HAL**, est destinée au dépôt et à la diffusion de documents scientifiques de niveau recherche, publiés ou non, émanant des établissements d'enseignement et de recherche français ou étrangers, des laboratoires publics ou privés.

Accepted Manuscript

Cell biology of H₂O₂ generation in the thyroid: Investigation of the control of dual oxidases (DUOX) activity in intact ex vivo thyroid tissue and cell lines.

C. Massart, C. Hoste, A. Virion, J. Ruf, J.E. Dumont, J. Van Sande

PII: S0303-7207(11)00308-X

DOI: [10.1016/j.mce.2011.05.047](https://doi.org/10.1016/j.mce.2011.05.047)

Reference: MCE 7885

To appear in: *Molecular and Cellular Endocrinology Molecular and Cellular Endocrinology*

Received Date: 8 March 2011

Revised Date: 6 May 2011

Accepted Date: 31 May 2011

Please cite this article as: Massart, C., Hoste, C., Virion, A., Ruf, J., Dumont, J.E., Van Sande, J., Cell biology of H₂O₂ generation in the thyroid: Investigation of the control of dual oxidases (DUOX) activity in intact ex vivo thyroid tissue and cell lines., *Molecular and Cellular Endocrinology Molecular and Cellular Endocrinology* (2011), doi: [10.1016/j.mce.2011.05.047](https://doi.org/10.1016/j.mce.2011.05.047)

This is a PDF file of an unedited manuscript that has been accepted for publication. As a service to our customers we are providing this early version of the manuscript. The manuscript will undergo copyediting, typesetting, and review of the resulting proof before it is published in its final form. Please note that during the production process errors may be discovered which could affect the content, and all legal disclaimers that apply to the journal pertain.



1

2

3

4 **Cell biology of H₂O₂ generation in the thyroid: Investigation of the control of dual**
5 **oxidases (DUOX) activity in intact ex vivo thyroid tissue and cell lines.**

6

7

8 C. Massart⁺, C. Hoste⁺, A. Virion[°], J. Ruf^{*}, J.E. Dumont, J. Van Sande

9 Institute of Interdisciplinary Research (IRIBHM), University of Brussels,

10 Campus Erasme, Route de Lennik 808, B 1070 Brussels, Belgium ; * UMR MD2 P2COE,

11 Faculté de Médecine Timone, F-13385 Marseille Cedex 5, France ; ° FRE 2939 CNRS Institut

12 Gustave Roussy Pavillon de recherche 2, 39 rue Camille Desmoulins, 94805 Villejuif.

13

14 ⁺equal first authors

15

16 Running head: Regulation of thyroid H₂O₂ generation in intact cells.

17 **ABSTRACT**

18

19 H₂O₂ generation by dual oxidase (DUOX) at the apex of thyroid cells is the limiting factor in
20 the oxidation of iodide and the synthesis of thyroid hormones. Its characteristics have been
21 investigated using different in vitro models, from the most physiological thyroid slices to the
22 particulate fraction isolated from transfected DUOX expressing CHO cells. Comparison of
23 the models shows that some positive controls are thyroid specific (TSH) or require the
24 substructure of the in vivo cells (MβCD). Other controls apply to all intact cell models such
25 as the stimulation of the PIP₃ phospholipase C pathway by ATP acting on purinergic
26 receptors, the activation of the Gq protein downstream (NaF), or surrogates of the intracellular
27 signals generated by this cascade (phorbol esters for protein kinase C, Ca⁺⁺ ionophore for
28 Ca⁺⁺). Still, other controls, exerted by intracellular Ca⁺⁺ or its substitute Mn⁺⁺, the
29 intracellular pH, or arachidonate bear directly on the enzyme. Iodide acts at the apical
30 membrane of the cell through an oxidized form, presumably iodoheptadecanal. Cooling of the
31 cells to 22°C blocks the activation of the PIP₃ phospholipase C cascade. All these effects are
32 reversible. Their kinetics and concentration-effect characteristics have been defined in the
33 four models. A general scheme of the thyroid signalling pathways regulating this metabolism
34 is proposed. The probes characterized could be applied to other H₂O₂ producing cells and to
35 pathological material.

36

37 Keywords: - Thyroid hormone synthesis,

38 - Iodide oxidation,

39 - Regulatory pathways,

40 - Physiological and pharmacological probes,

41 - In vitro quasi physiological model

42 **INTRODUCTION**

43

44 The thyroid gland is composed of follicles with thyrocytes surrounding a lumen. To
45 synthesize thyroid hormones, thyrocytes take up iodide at their basal side and concentrate it
46 into the lumen. They also secrete in this lumen the specialized protein thyroglobulin which
47 serves as a store for the hormones. The first step in the synthesis of thyroid hormones is the
48 oxidation of iodide by thyroperoxidase (TPO) and H_2O_2 and its binding to thyroglobulin
49 tyrosines, to form iodotyrosines. The second step is the oxidative coupling of these
50 iodotyrosines into iodothyronines, thyroxine and triiodothyronine, within thyroglobulin. The
51 thyroid protein iodination and thyroid hormone synthesis system is constituted of H_2O_2
52 generating enzymes, the dual oxidases 1 and 2 (DUOXes) and an iodide and iodotyrosine
53 oxidation enzyme, TPO. The essential role of the DUOXes is demonstrated by the inhibition
54 of H_2O_2 generation by DUOX1 siRNAs in the rat PCC13 thyroid cell line (Rigutto et al.,
55 2007). While DUOXes are essentially controlled acutely with little effect of TSH on their
56 expression (Milenkovic et al., 2007), TPO is mostly controlled at this level (Song et al.,
57 2007). DUOX expression in human thyroid pathological samples shows no relation with the
58 level of thyroid stimulation (Caillou et al., 2001). Iodide oxidation and iodination of
59 thyroglobulin by thyrocytes, thus presumably also H_2O_2 generation, has been demonstrated to
60 occur at the apical microvillar membrane (Ekholm and Bjorkman, 1984) where the TPO and
61 the DUOXes are located (Song et al., 2007). This architecture, concentrating all the elements
62 for this synthesis at the apical interface and the thyroglobulin substrate in the lumen, is crucial
63 as shown by the fact that isolated thyroid cells or a polarized rat thyroid cell line do not
64 organify iodide or synthesize thyroid hormones. Under normal conditions (iodide
65 concentration lower than $10 \mu M$) the iodination process is not limited by H_2O_2 generation but
66 by the iodide supply through the transporter NIS. This is illustrated by the hyperthyroidism of

67 autonomous adenomas which take up more iodide but generate less H_2O_2 than normal tissue
68 (Deleu et al., 2000). H_2O_2 is however necessary, as shown by the congenital hypothyroidism
69 of patients with DUOX2 defects (Hoste et al., 2010; Moreno et al., 2002).

70 The thyroid cell generates as much H_2O_2 as an activated leucocyte (Song et al., 2007)
71 and must protect itself against it. Increasing H_2O_2 generation by thyroid stimulation and
72 decreased protection against this H_2O_2 by selenium deficiency cause thyroid destruction and
73 in human, myxoedematous cretinism (Contempre et al., 1995).

74 The synthesis of H_2O_2 is catalyzed by the dual oxidases, DUOX1 and DUOX2, two
75 thyrocyte apical transmembrane enzymes, using NADPH_2 as coenzyme. Among the NADPH
76 oxidases (NOXes), DUOX1 and DUOX2 are the only ones directly generating H_2O_2 at the
77 outside of the cell instead of producing O_2^- , mostly inside the cell, as the other NOXes do.
78 The DUOXes are composed of an extracellular NH_2 terminal, a first intracellular domain with
79 two EF hand motifs which bind calcium, six transmembrane segments and a C terminal
80 intracellular tail containing an heme and the FAD and NADPH_2 binding domains (De Deken
81 et al., 2000). Whereas the DUOXes, contrary to the other NOXes, do not seem to need
82 associated cytosolic factors to be active, they require two transmembrane maturation factors
83 (DUOXA1 for DUOX1, DUOXA2 for DUOX2) to reach the apical membrane, to acquire
84 their active conformation and achieve their final glycosylation status (Grasberger and
85 Refetoff, 2006).

86 In all species, H_2O_2 generation is stimulated by the two intracellular signals of the Gq-
87 phospholipase C cascade, Ca^{++} and diacylglycerol. In human and pigs, it is not stimulated by
88 cyclic AMP. In these species, the TSH receptor-Gq-phospholipase C cascade is therefore the
89 main regulatory control exerted (Song et al., 2010a). Iodide, through an iodinated derivative,
90 presumably iodoheptadecanal (IHDA), both stimulates in a first stage, and then inhibits H_2O_2

91 generation (Corvilain et al., 1988; Corvilain et al., 2000) in these species with increasing
92 iodide concentrations.

93 Our group has studied the control of the two DUOXes at the biochemical level
94 (Rigutto et al., 2009). While human DUOX1 is activated by cAMP through protein kinase A,
95 DUOX2, as human and pig thyrocytes H_2O_2 generation, is not. DUOX2 is extremely
96 sensitive to the activation by phorbol ester (TPA). Strangely, while congenital
97 hypothyroidism due to DUOX2 inactivation has been observed several times, no such defect
98 has been found for DUOX1 although both mRNAs are expressed in the human thyroid (albeit
99 with a lower expression of DUOX1) (Pachucki et al., 2004). In other organs (eg. aerial and
100 digestive mucosae), DUOX1 or DUOX2 function similarly as defense mechanisms (Fischer,
101 2009).

102 In this work we study the regulation of H_2O_2 generation in the thyroid in a near
103 physiological ex vivo model of thyroid slices with direct access to the H_2O_2 producing apical
104 pole of the cell. To distinguish the characteristics conferred to these enzymes by the
105 specialized structure and cell specific properties of the thyrocyte, we have compared this
106 regulation in ex vivo pig and sheep thyroid slices, in a rat thyroid cell line PCC13, and in CHO
107 cells stably expressing each DUOX enzyme. We also define the experimental systems, the
108 kinetic characteristics of the physiological and pharmacologic probes of the system and the
109 metabolic requirements of H_2O_2 generation and disposal. For clarity and as they are closer to
110 the physiological situation, figures mostly present data on slices.

111

112 MATERIALS AND METHODS

113 1) Reagents.

114 Phorbol myristate ester (TPA), homovanilic acid (HVA), horse radish peroxidase type
115 II (HRP), ionomycin, forskolin, TSH, Methyl- β -cyclodextrine, arachidonic acid and

116 superoxide dismutase were purchased from Sigma-Aldrich (Bornem, Belgium). Amplex
117 Ultra Red and H_2O_2 were purchased from Invitrogen (Merelbeke, Belgium).
118 Myeloperoxidase from human polymorphonuclear leukocyte was from Calbiochem
119 (Nottingham, UK). Human TPO was purified from Graves' thyroid tissue by monoclonal
120 antibody-assisted chromatography as previously reported (Czarnocka et al., 1985).

121

122 **2) Cell Culture.**

123 PCC13 cells, a rat thyroid cell line, were grown in Coon's modified Ham's F12
124 medium supplemented with 5% decompemented fetal bovine serum, bovine TSH (1 mU/ml),
125 transferrin (5 μ g/ml), insulin (1 μ g/ml), penicillin (100 IU/ml), streptomycin (100 μ g/ml), and
126 fungizone (2,5 μ g/ml).

127 CHO cells were stably transfected with either HA-DUOX1/DUOXA1-myc (CHOD1)
128 or HA-DUOX2/DUOXA2-myc (CHOD2) as described elsewhere (Botteaux et al., 2009).
129 These cells were cultured in Ham's F-12 medium supplemented with fetal bovine serum
130 (10%), penicillin (100 IU/ml) streptomycin (100 μ g/ml), fungizone (2.5 μ g/ml) and sodium
131 pyruvate (1mM). Cells (5×10^5 for PCC13 cells and 3×10^5 for CHOD1 or CHOD2 cells) were
132 plated in 3.5 cm diameter dishes or wells, 2 days before the experiment.

133 COS-NIS cells are COS-7 cells transfected with the wild type human sodium/iodide
134 symporter (NIS) cDNA. Stable cell lines were selected by resistance to geneticin, and one
135 clone, COS-NIS 6 with a large capacity to accumulate iodide was selected (Pohlenz et al.,
136 2000).

137 Pig and sheep thyroids were obtained at the local slaughterhouse. The fresh tissue was
138 sliced at room temperature with a Stadie-Riggs microtome (Arthur Thomas, Philadelphia,
139 PA). Slices (0.3 mm thick) of 50–100 mg wet weight were incubated in 2 ml incubation
140 medium (Corvilain et al., 2000).

141

142 **3) Generation of the cellular particulate fractions.**

143 Cells plated in 9 cm diameter dishes were rinsed twice with ice cold PBS and scraped
144 into the same solution supplemented with a cocktail of protease inhibitors (Roche Molecular
145 Biochemicals, Vilvoorde, Belgium). After centrifuging at 200 x g for 10 min at 4°C, the cell
146 pellet was homogenized using a motor driven glass Teflon homogenizer in 2 ml of sodium
147 phosphate buffer (50 mM) (pH 7.2) containing EGTA (1 mM), MgCl₂ (2 mM) and the
148 cocktail of protease inhibitors. After centrifuging at 200,000 x g for 30 min at 4°C, the pellet
149 was resuspended in 0,3 ml of sodium phosphate buffer (50 mM) (pH 7.2) containing MgCl₂
150 (2 mM), sucrose (250 mM) and the mixture of protease inhibitors. The suspension was
151 homogenized once again (Ameziane-El-Hassani et al., 2005).

152

153 **4) Measurement of the H₂O₂ production.**

154 4.a) Tissue :

155 Slices were preincubated 1 h in Krebs-Ringer HEPES (KRH) medium
156 supplemented with 8 mM glucose and 0.5 g/l BSA and then transferred to fresh medium
157 containing 0.1 mg/ml HRP, 440 μM HVA and the tested agonists. When H₂O₂ is produced
158 by the tissue, the HVA is oxidized into a fluorescent dimer by the peroxidase. The
159 fluorescence of the medium was measured at 315 and 425 nm excitation and emission
160 wavelengths respectively (Benard and Brault, 1971). Generation of H₂O₂ was expressed as ng
161 H₂O₂ produced by 100 mg of tissue during the length of the incubation (Corvilain et al.,
162 1991).

163

164 4.b) Cells :

165 The day of the experiment, the cells were rinsed and preincubated 30 min in KRH
166 medium. The medium was withdrawn and fresh medium containing HVA 440 μM , HRP 0.1
167 mg/ml, and the agent under study was added. H_2O_2 was measured as explained for tissues
168 (Botteaux et al., 2009).

169

170 4.c) Particulate fraction :

171 Measurements of H_2O_2 generation by the particulate fraction were carried out as
172 described by the group which has developed this subject. Samples of the fraction were
173 incubated at 30°C in 100 μl of sodium phosphate 200 mM, pH 7.2, containing EGTA (1 mM),
174 CaCl_2 (1.5 mM), MgCl_2 (200 μM), sucrose (25 mM), Superoxide Dismutase (40 U), HRP (25
175 mU) and Amplex Ultra Red (50 μM). The reaction was started by adding NADPH (100 μM).
176 The Ca^{++} dependence of H_2O_2 formation was assessed in parallel samples incubated without
177 Ca^{++} in the presence of 1 mM EGTA. The amount of H_2O_2 in each sample was measured by
178 monitoring the increase in resorufin fluorescence (excitation 544 nm; emission, 595 nm)
179 during 1 hour in a SpectraMax[®] M5 spectrofluorimeter from Molecular Devices. The activity
180 of DUOXes was calculated using a standard curve ranging from 0.1 to 1 μM H_2O_2
181 (Ameziane-El-Hassani et al., 2005).

182

183 The standard curves were always done in a medium similar to the experimental
184 incubation medium (pH, ionic composition, substrates, enzymes, pharmacologic agents, etc).

185

186 **5) Inositol phosphates measurements.**

187 5.a) Tissue :

188 Slices were preincubated for 4 h at 37°C in KRH medium containing 40 $\mu\text{Ci/ml}$ [³H]-
189 labeled inositol (specific activity 10–20 Ci/mmol, Amersham, Biosciences Benelux,

190 Rosendaal, The Netherlands). Then, the slices were lightly dried on paper and transferred
191 to fresh unlabeled incubation medium. After 15 min, the slices were transferred to a third
192 medium containing LiCl 10 mM. After an additional 5 min, the test agents were added. The
193 following 1 h incubation was stopped by rapid immersion of the slices in 3% ice cold
194 perchloric acid (PCA). After homogenization and centrifugation, the supernatant was
195 collected and prepared to isolate the [³H] inositol phosphates (IPs) by stepwise
196 chromatography on a AG-1-X8 resin (formate form, 100–200 mesh, Bio-rad, Watford, UK)
197 (Berridge, 1983). The incorporation of [³H] inositol into the total phosphatidylinositides (PI)
198 pool was estimated from the tissue pellet, dissolved in 1 M NaOH and counted as total PI.
199 The amount of [³H] IPs formed was expressed as a percentage of the PI plus IPs pool (Graff et
200 al., 1987).

201

202 5.b) Cells :

203 After 24 hours culture, the medium was replaced by fresh culture medium containing
204 25 µCi/ml [³H] inositol for 24h. The cells were rinsed twice with 1 ml KRH medium and
205 preincubated 30 min in KRH medium containing 10 mM LiCl. The medium was then
206 replaced by the same medium containing the agents under study. At the end of the test
207 incubation (15 min for CHO transfected cells and 30 min for PCC13 cells) the medium was
208 withdrawn and 1 ml 3% cold PCA was added to the cell dishes kept on ice for at least 15 min.
209 The PCA extract was removed carefully without scraping the cells, and processed for
210 stepwise chromatography as the tissues. After 1 rinse, the cells were dissolved in 1 M NaOH
211 and counted as total PI. Results are expressed as for tissue (Raspe et al., 1991).

212

213 **6) Iodide organification (PB¹³¹I).**

214 Thyroid slices were preincubated 1 h in KRH medium, with 8 mM glucose and 0.5
215 g/l BSA, then transferred to fresh medium supplemented with KI 10 μ M and 131 I (1
216 μ Ci/ml) for 30–90 min. Methimazole (0.1 mM) a blocker of iodide organification, added
217 during preincubation and incubation, was used to estimate the background of the method. The
218 slices were then homogenized in a methimazole solution (2×10^{-3} M). The proteins were
219 precipitated with 10% trichloroacetic acid (TCA) and counted. Results were expressed as the
220 ratio between trichloroacetic acid precipitable radioactivity and the total radioactivity in the
221 slices, in percentage.

222 Iodide uptake was evaluated in tissue, by dividing the radioactivity in 100 mg tissue
223 by the radioactivity in 100 μ l medium. NaClO_4 1mM, a blocker of iodide transport, was used
224 as a control. For cells, the iodide transport was estimated by dividing the radioactivity in the
225 cells by the radioactivity measured in similar dishes incubated with NaClO_4 . The uptake in the
226 presence of NaClO_4 is considered as the background of the method (Deleu et al., 2000). This
227 gives a ratio comparable for different preparations of cells independent of the number of cells.

228

229 RESULTS

230 1) Definition of the model

231 Thyroid slices have often been used for the study of H_2O_2 generation and iodide
232 binding to proteins. However histological examination of the slices shows two types of
233 structures: open follicles facing the incubation medium on both external faces of the slice and
234 closed intact follicles containing thyroglobulin inside the slice (Neve and Dumont, 1970).
235 The inside closed follicles, but not the open follicles, take up iodide and bind it to
236 thyroglobulin as normal follicles *in vivo*. On the other hand, given the fact that thyroid cells
237 are extremely well equipped to reduce H_2O_2 , we presume that H_2O_2 produced in the closed
238 follicles does not leak out. Thus thyroid slices contain one compartment in which the

239 generated H_2O_2 feeds the normal iodination process as in vivo, and another which generates
240 H_2O_2 in the incubation medium. Both compartments can be investigated separately in the
241 same system, iodination by I^{125} binding to proteins, and the H_2O_2 generation at the apex of the
242 cell by trapping this H_2O_2 as oxidized HVA in the presence of excess HRP (Fig. 1).

243 Consistent with this concept, H_2O_2 generation by the slices is suppressed by excess
244 medium catalase while iodide binding to thyroglobulin is not affected (Table 1). Similarly,
245 the amount of H_2O_2 produced by very thin or thick pig and sheep thyroid slices of roughly the
246 same size is identical and proportional to the surface but not to the weight of the slices, while
247 iodide binding to protein is grossly proportional to their weight. The percentage of iodide
248 taken up, which is incorporated into proteins, is the same in both types of slices (Table 2).
249 With regard to H_2O_2 generation, the slices model with open follicles is therefore similar to the
250 free open pig thyroid follicles studied by Bjorkman (Bjorkman and Ekholm, 1984) in which
251 the H_2O_2 generation was demonstrated by cerium perhydroxide precipitation at the apical
252 membrane.

253 Whereas 20 μM H_2O_2 is completely hydrolyzed by 10 IU/ml of catalase in 30 min in
254 the absence of HRP, in the presence of 100 $\mu g/ml$ HRP, 33 IU/ml of catalase only slightly
255 decreased the H_2O_2 oxidation of HVA. Thus at the concentration of HRP and HVA generally
256 used, H_2O_2 is more rapidly used in HVA oxidation reaction and thus trapped instead of being
257 reduced by catalase: the H_2O_2 measurement in the slices medium therefore represents the real
258 integral measure of H_2O_2 generation. Consistent with this, the measurement increases linearly
259 with time (Fig. 2).

260

261 2) Control of H_2O_2 generation

262 2.a) Effects of iodide on H_2O_2 generation.

263 We have shown previously (Corvilain et al., 2000) that iodide enhances, after a one
264 hour preincubation, the generation of H_2O_2 in pig, dog and human thyroids. This effect
265 makes physiological sense in conditions of highly variable iodide supply, as it activates the
266 iodide oxidation system when iodide is present. At higher concentrations iodide inhibits H_2O_2
267 generation, which is known as the Wolf-Chaikoff effect (Corvilain et al., 1988). The effects
268 of iodide in the intact dog thyroids are inhibited by perchlorate which blocks iodide uptake
269 and methimazole which blocks its oxidation (Van Sande and Dumont, 1973). This led to the
270 conclusion that iodide acts through an intrafollicular iodinated derivative (XI) (Van Sande et
271 al., 1975), which is believed to be iodoheptadecanal (IHDA) (Ohayon et al., 1994; Panneels et
272 al., 1994a).

273 If XI is generated at the apical membrane of the cell, where both DUOX and TPO are
274 located facing the lumen, and if in closed follicles the iodide taken up is located in the
275 follicular lumen, then in open follicles iodide would have a direct access to the system. In this
276 case, iodide transport would no longer be necessary for XI generation, and perchlorate would
277 no longer inhibit XI effect. Indeed in pig thyroid slices, the delayed stimulatory effect of
278 iodide (10 μ M) was inhibited by methimazole but not by perchlorate (Fig. 3). Such result also
279 suggests that the presumed XI is not diluted in the medium but remains in the membrane to
280 interact directly with DUOX.

281

282 2.b) Effect of physiological and pharmacological stimulants

283 In the thyroid of all the investigated species, H_2O_2 generation is stimulated by the Gq-
284 phospholipase C cascade. It is also stimulated by the cAMP-PKA cascade in dog, rat and
285 mouse but not in the other species including humans and pigs (Song et al., 2010a). TSH
286 activates the Gq-PLC cascade in all species studied except dog (Song et al., 2010a). The
287 activation of H_2O_2 generation involves both arms of the Gq cascade, the diacylglycerol-PKC,

288 and the IP_3 - Ca^{++} pathways, as phorbol ester (TPA) and calcium ionophore (ionomycin)
289 reproduce it. Since the ubiquitous purinergic receptors (P_2Y) activate the cascade in most cell
290 types including human thyrocytes (Raspe et al., 1989), ATP γ s was also used to probe the
291 system. TPA, ionomycin and ATP γ s did not enhance cAMP accumulation. Finally NaF had
292 been proposed as a stimulator of H_2O_2 generation because it also activates the pentose
293 phosphate pathway which feeds the NADPH $_2$ substrate of DUOX (Dumont, 1971) and was
294 shown to be active in this regard in human thyroid slices (Corvilain et al., 1994).

295 In the four experimental systems and for TSH in the two thyroid models (pig thyroid
296 slices and the PCCI3 rat thyroid cell line), all these physiological and pharmacological agents
297 enhanced H_2O_2 production. Table 3 gives a general summary of effects of physiological and
298 pharmacological probes in the various models. TSH activated H_2O_2 generation in pig thyroid
299 slices and PCCI3 cell line with an EC50 of 3 mU/ml for pig slices and 5 mU/ml for the less
300 responsive PCCI3 cells. The concentration-effect relations were similar for H_2O_2 and IP_3
301 generation but higher than for cAMP accumulation, for which they plateaued at 0.3 mU/ml.
302 Forskolin (0.5 to 5 μ M), a direct probe of Gs-adenylyl cyclase, did not activate H_2O_2
303 generation in pig and human thyroid slices, nor in PCCI3 or CHOD2 cells but it did activate it
304 in CHOD1 cells (Rigutto et al., 2007) and at 10 μ M in PCCI3 cells.

305 ATP γ s activated H_2O_2 production in pig slices with an EC50 of 10 μ M, in PCCI3 cells
306 with an EC50 of 20 μ M, in CHOD1 cells with an EC50 of 2 μ M, and in CHOD2 cells with a
307 EC50 of 0.3 μ M. In the latter cells, the much higher DUOX expression does not allow the
308 cells to reach the real V_{max} of the enzyme. It also stimulates the whole cascade in human
309 thyroid primary cultures (Raspe et al., 1989; Raspe et al., 1991) and FRTL5 cells (Bjorkman
310 and Ekholm, 1992).

311 TPA enhanced H_2O_2 generation in pig slices with an EC50 of 0.1 μ M, in PCCI3 cells
312 with an EC50 of 10 μ M, and in CHOD1 and CHOD2 cells with EC50 of 2 μ M and 10 nM

313 respectively. Similar effects have been observed in pig thyroid cells in culture and in FRTL5
314 cells (Bjorkman and Ekholm, 1992). As expected, the effect of TPA 5 μM but not that of
315 ionomycin was 90% inhibited by the PKC inhibitor RO 318220 (5 μM) (not shown).

316 Ionomycin activated H_2O_2 production in pig slices with an EC_{50} of 0.1 μM , in PCCl3
317 cells with an EC_{50} of 0.08 μM and in CHOD1 and CHOD2 cells with EC_{50} of 0.5 μM and
318 0.08 μM respectively.

319 NaF enhanced H_2O_2 generation in pig slices with an EC_{50} of 4 mM, in PCCl3 cells
320 with an EC_{50} of 5 mM, and in CHOD1 and CHOD2 cells with EC_{50} of 6 mM. This effect
321 was minimal at 2 mM and maximal at 10 mM. The effects of ionomycin and NaF were
322 qualitatively similar in pig and human thyroid slices (not shown).

323 Similarly, TSH, ATP, ionomycin, TPA and increased pH=8 enhanced protein
324 iodination in pig and human thyroid slices (not shown) as TSH, ionomycin and TPA do in
325 other species (Song et al., 2010a).

326 Thus only the TSH response required thyroid cell specificity. The other probes, which
327 test the activation of the Gq PLC cascade and the direct effects of PKC and Ca^{++} on the
328 DUOXes (Rigutto et al., 2009), act in all models.

329 Interestingly, EGF (100 ng/ml) and calf serum (10%) enhanced H_2O_2 generation by
330 pig thyroid slices by 16% ($P<0.05$) and 36% ($P<0.05$) respectively, while insulin 10 $\mu\text{g}/\text{ml}$
331 had no effect (not shown). Such effects might reflect a spillover of H_2O_2 generated
332 intracellularly by an activated NOX4 (Weyemi et al., 2010).

333 In pig thyroid slices, the kinetics of basal H_2O_2 generation were quasi linear for 2
334 hours and the effects of ionomycin (1 μM), TPA (5 μM) and TSH (10 mU/ml) were constant
335 from 30 to 120 min. The effect of NaF 10 mM reached its steady state only after 30 min (Fig.
336 2). Similar kinetics were obtained in PCCl3 and in CHOD1 cells in which the effects of

337 ionomycin, TSH and ATP γ s were constant for two hours while the full effect of NaF was
338 delayed.

339 On the other hand when slices incubated with the stimulatory agent for one hour were
340 reincubated without stimulant for various times up to two hours, the rate of H₂O₂ generation
341 remained steady for one hour for NaF 10 mM, decreased over one hour for TPA 5 μ M,
342 disappeared rapidly for ionomycin 1 μ M and immediately for ATP γ s and TSH. Similar
343 results were obtained in PCC13 cells. However in CHOD1 cells the TPA effect persisted for
344 30 min, and that of NaF for 15 min, while the effects of both ATP γ s and ionomycin
345 disappeared after cell washing. These results are compatible with an intracellular action of
346 NaF and TPA, and the known extracellular action on receptors of TSH and ATP γ s (Table 4).
347 For comparison the half-life of cAMP after the cutoff of TSH stimulation by trypsin treatment
348 is less than 10 min in dog thyroid slices (Van Sande et al., 1977).

349

350 2.c) Mechanism of NaF action

351 NaF has been used as an activator of the H₂O₂ generating system on the basis of its
352 stimulatory effect of the pentose phosphate pathway (Dumont, 1971). Indeed it greatly
353 activates this generation in the four experimental models used. However, its mechanism of
354 action was unknown.

355 One hypothesis is that NaF could act directly or indirectly on the H₂O₂ generating
356 system by inhibiting serine-threonine protein phosphatases. However inhibition of these
357 phosphatases by okadaic acid 1 μ M barely stimulated the generation of H₂O₂ in pig thyroid
358 slices and inhibited it in CHOD1, CHOD2 and PCC13 cells (not shown). A direct effect of
359 NaF on DUOX in particulate preparations was not observed (0.1 to 10 mM) (not shown).

360 NaF also inhibits glycolysis and some depending functional variables of thyroid cells
361 such as secretion (Willems et al., 1972). The transport of iodide, which also depends on
362 glycolysis, was barely reduced at 4 mM and reduced by 50 % at 10 mM (not shown).

363 NaF has often been used as a stimulant of the protein Gs (Gilman, 1987). The anion
364 would fill the space of the 3rd phosphate of GTP in GDP and convert the inactive GDP into an
365 active GDP-F form. It could play a similar role in Gq. Indeed in all four experimental
366 models, pig slices, PCC13, CHOD1 and CHOD2, NaF enhanced H₂O₂ and IP generation with
367 similar concentration action relations. The first effective NaF concentration is 4 mM and a
368 larger, often maximal, effect is obtained at 10 mM. Fluoride indeed raises steadily
369 intracellular Ca⁺⁺ levels as well as inositol phosphates in dog thyroid cells (Graff et al., 1987;
370 Raspe et al., 1986). Thus NaF is a good probe of the Gq-PLC pathway, presumably at the
371 level of Gq.

372

373 3) Metabolic properties of the system.

374 In thyroid acellular systems, DUOX, as a NADPH₂ dependent thyroid oxidase, uses
375 NADPH₂ as a substrate, the resulting NADP⁺ being reduced by the pentose phosphate
376 pathway. Similarly, it has been assumed that extracellular H₂O₂ leaking into the cell would be
377 reduced by glutathione peroxidase, the oxidized GSSG being reduced by NADPH₂ and
378 glutathione reductase, and the NADP⁺ by the pentose phosphate pathway. These two
379 mechanisms could explain the important activation of the pathway by TSH (Dumont, 1971).

380

381 3.a) Generation of H₂O₂

382 The generation of H₂O₂ by pig thyroid slices was measured in the presence and
383 absence of glucose, after a preincubation of 1h, during an incubation of 30 to 60 min.
384 Without glucose, the spontaneous release of H₂O₂ was depressed by 50 to 80% while the

385 activation by TSH, TPA, ionomycin and NaF was almost suppressed (Fig. 4). Similar effects,
386 albeit weaker, were obtained with human thyroid slices (not shown). In both human and pig
387 slices 1 mM glucose was sufficient for maximal H₂O₂ generation. In CHOD1 and CHOD2
388 cells basal H₂O₂ was increased from no glucose to glucose 0.4 mM, but little increased over
389 0.4 mM. However, the stimulatory effects of TPA, ionomycin, NaF and ATP γ s were reduced
390 without glucose. Clearly higher levels of stimulation required higher glucose concentrations
391 to achieve a maximal effect. Glucose depletion did not reduce basal or ATP γ s stimulated
392 H₂O₂ generation by PCC13 cells which raises the question of the source of NADPH₂ in these
393 cells (not shown). Thus the reliance on extracellular glucose for H₂O₂ generation is important
394 for physiological but less so, for model systems.

395

396 3.b) O₂ requirements of DUOX

397 The two substrates of the DUOXes are NADPH₂ and O₂. All the experiments carried
398 out on H₂O₂ generation are carried out in an atmosphere of air, i.e. at 20% oxygen. However
399 the O₂ partial pressure in which the system operates in vivo may vary much. While in most
400 tissues, including the thyroid, the partial pressure of O₂ would be between 4% and 10% of the
401 atmosphere, DUOX1 in the airway is exposed to an atmosphere of air i.e. 20% O₂, while
402 DUOX2 in the anaerobic colon mucosa probably encounters much lower O₂ levels. It was
403 therefore of interest to test the O₂ requirements of both isoenzymes. We tested H₂O₂ steady
404 state generation under condition of 2% vs 20% O₂, adding HRP and HVA after an incubation
405 period of 30 or 45 min, i.e. at a time when we could expect that the media were fully
406 equilibrated with the atmosphere. Under these conditions, basal steady state H₂O₂
407 concentration in the medium was 22 ± 1 ng/dish in 2% O₂ and 43 ± 1 ng/dish in 20% O₂ for
408 CHOD1 cells and 400 ± 5 vs 470 ± 20 ng/dish for CHOD2 cells. Interestingly the cells
409 stimulated with TPA 5 μM, gave identical results at both O₂ concentrations: 104 ± 2 and 111

410 ± 3 ng/dish for CHOD1 cells, 1480 ± 25 and 1343 ± 30 ng/dish for CHOD2 cells. Similar
411 results were obtained in six experiments while in 2 experiments there was no decrease in
412 H_2O_2 generation for either CHOD1 or CHOD2 at 2% O_2 . The effects of 2% O_2 were not
413 observed at 4% O_2 . Thus DUOX1 which is exposed in the trachea to high O_2 has a higher
414 K_m and lower affinity for O_2 than DUOX2 which is expressed in the colon while the V_{\max} of
415 the enzymes are similar at both O_2 concentrations.

416

417 3.c) Disposal of H_2O_2

418 When stimulated, the thyrocyte generates as much H_2O_2 per cell as an activated
419 polynuclear leukocyte (Song et al., 2007). However whereas an activated leukocyte survives
420 a few hours, the adult human thyrocyte lives around seven years (Coclet et al., 1989). The
421 thyrocyte must therefore be well equipped to detoxify H_2O_2 .

422 A first defense is certainly the consumption of H_2O_2 during the TPO oxidation of
423 iodide. However we showed previously (Corvilain et al., 1991) that H_2O_2 is generated at
424 almost two orders of magnitude higher levels than the amounts used for iodide oxidation. A
425 first hypothesis was therefore that TPO could, even in the absence of iodide substrate, degrade
426 H_2O_2 . Horse radish peroxidase has both peroxidase and catalase activities but while the first
427 was maximal at $30 \mu\text{M}$ H_2O_2 , the EC_{50} of the other was $600 \mu\text{M}$ (not shown). Purified
428 human TPO ($40 \mu\text{g/ml}$) has a very slight catalase effect in the absence of iodide (25% H_2O_2
429 degraded in 90 min for a concentration of $10 \mu\text{M}$ H_2O_2). Human myeloperoxidase, in the
430 same conditions, degraded 95% of the H_2O_2 . The effect of TPO on H_2O_2 degradation is
431 negligible when compared with the degradation in the presence of iodide (99%). A high
432 degradation of H_2O_2 by pig TPO in the presence of iodide has been previously demonstrated
433 (Magnusson and Taurog, 1983). Thus purified TPO has a negligible catalase like activity.

434 In short incubations and even in the presence of low concentrations of HRP (to
435 minimize the sequestering effect of HRP-HVA), methimazole 0.1 mM, a potent peroxidase
436 inhibitor, did not increase the generation of H_2O_2 by pig thyroid slices. This suggests that in
437 open follicles, when not functioning as a peroxidase, TPO had no significant catalase like
438 effect. Consumption of H_2O_2 by TPO in the presence of iodide or KSCN could be expected
439 to decrease net H_2O_2 generation. However, acute decreasing effect (30 min) of KI 10 and 100
440 μ M, or SCN^- 100 μ M, as substrates of TPO in the presence of 10 μ g/ml HRP (i.e. a non
441 sequestering level of the enzyme) on H_2O_2 generation by pig thyroid slices were not
442 significant (not shown). Their effect was obviously masked by the rapid free diffusion of
443 H_2O_2 from the open follicles out of membrane TPO's reach.

444 Peroxisomes, the repository of catalase, have been demonstrated in thyroid cells (Tice,
445 1974). NaN_3 is the most used inhibitor of catalase. It does not inhibit H_2O_2 generation by pig
446 thyroid slices, CHOD1 and CHOD2 cells until a concentration of 1 mM. Its EC_{50} for
447 catalase is 33 μ M. The half life of H_2O_2 added to pig thyroid slices is of 8 min in the
448 presence of NaN_3 33 μ M and 2.5 min without it, i.e. an inhibition of 70%.

449 H_2O_2 degradation by pig or human thyroid slices was partially (20 to 30 %) increased
450 by the presence of glucose (8 mM) in the medium (Fig. 5). For pig thyroid slices a
451 preincubation of 4 hours in the presence of BSO 200 μ M, which depletes intracellular GSH
452 (Driessens et al., 2009), did not enhance H_2O_2 generation. Thus at high concentrations of
453 H_2O_2 a large part of the H_2O_2 degradation by pig thyroid slices is carried out by cell catalase
454 rather than by glutathione and the pentose phosphate pathway.

455 Degradation of added H_2O_2 by PCCI3 cells was slow ($t_{1/2} = 7$ min) and was only
456 marginally slowed down by NaN_3 33 μ M. With CHOD1 and CHOD2 cells, the half life was
457 12 min, marginally increased by glucose depletion but extended to 18 min by NaN_3 100 μ M.

458 Thus in all models, the major degradation pathway of a rather high concentration of
459 exogenous H_2O_2 is catalase.

460

461 4) Physicochemical conditions of H_2O_2 generation

462 4.a) Temperature and membrane fluidity

463 The DUOX enzymes are thyroid apical membrane proteins. They are incompletely
464 glycosylated and inactive until they have reached this location. There are indications that the
465 whole protein iodination apparatus, including DUOXes and TPO are located in the membrane
466 of microvillae and that these membranes contain rafts and caveolae. One might therefore
467 wonder about the role of membrane structure on DUOX activity (Song et al., 2007). In a
468 previous publication, we had shown in intact cells, that some apical membrane functions such
469 as macropinocytosis and protein iodination as well as activation of adenylate cyclase at the
470 basal membrane by cholera toxin, which requires prior endocytosis, were obliterated at 22°C
471 while other functions such as iodide transport or TSH activation of adenylate cyclase via its
472 receptor were not (Van Sande et al., 1979).

473 In COS-NIS and PCCI3 cells iodide transport is not decreased at 21°C (not shown). In
474 acellular systems the shift from 37°C to 22°C decreases H_2O_2 generation by 10% (not
475 significant). Measurements of H_2O_2 generation by thyroid particulate fractions are routinely
476 made at 20°C (Michot et al., 1985) which bears against the hypothesis of an important direct
477 effect of lower temperature on DUOXes themselves. In pig and dog thyroid slices, basal
478 H_2O_2 generation on the whole was not greatly affected by the decrease in temperature
479 (sometimes moderately increased or decreased). On the other hand, the stimulatory effects of
480 TSH and TPA were greatly decreased and those of NaF were almost suppressed while the
481 effects of ionomycin were decreased (Fig. 6). Similar results were obtained for iodination. In
482 pig slices the TSH effect on cAMP accumulation was not modified (not shown). In PCCI3,

483 CHOD1 and CHOD2 cells the basal generation of H_2O_2 was decreased by 50%. As in the
484 slices, the effect of NaF was suppressed while those of ionomycin and TPA were decreased.
485 In PCCl3 cells the effect of TSH and $ATP\gamma_s$ were decreased while the effect of NaF was
486 suppressed (not shown). Thus lowering the temperature in thyroid cells did not greatly modify
487 the basal activity of the H_2O_2 generating system but it greatly influenced its control. Indeed,
488 IP generation in response to NaF was obliterated at 22°C in PCCl3 cells. Consonant with this,
489 in pig thyroid slices, the effects of TSH and $ATP\gamma_s$ on H_2O_2 generation shut down
490 immediately when the slices were brought to 22°C (not shown). This suggests that
491 stimulation of H_2O_2 generation requires the constant activation of the Gq PLC cascade.

492

493 4.b) Effects of membrane structure

494 Human and dog thyrocytes plasma membrane have been shown to contain lipid rafts
495 or detergent resistant membrane fragments (Costa et al., 2004). Such rafts are rich in
496 cholesterol and dissociate when deprived of cholesterol. There is indirect evidence that apical
497 membranes are richer in cholesterol i.e. presumably in rafts. We have proposed that apical
498 membrane DUOXes and TPO might be sequestered in such structures (Song et al., 2007). If
499 true, cholesterol deprivation could lead either to an activation or inactivation of H_2O_2
500 generation, depending on the role of raft in the sequestration.

501 Methyl- β -cyclodextrin ($M\beta CD$) is generally used to deplete cells or membranes of
502 cholesterol. Such a treatment by $M\beta CD$ in vitro has been shown previously to deplete the
503 thyroid cells of cholesterol, to disrupt rafts, but not to interfere with TSH action on cAMP
504 (Costa et al., 2004). $M\beta CD$ 10 mM pretreatment of slices for 30 min greatly increased H_2O_2
505 generation in a subsequent incubation in pig and sheep thyroid slices (Fig. 7). This effect was
506 greatly decreased at 22°C. A maximal effect was obtained at 10 mM. The effect of $M\beta CD$
507 was not increased if the drug was also present in the second incubation but it was lower when

508 M β CD was present during the measuring incubation only. Thus better results are obtained
509 with cells pretreated with M β CD and already deprived of cholesterol. M β CD had no such
510 effect on PCCl₃, CHOD1 or CHOD2 cells (0.1 to 10 mM). This effect of M β CD on thyroid
511 cells is not a direct effect on the enzyme, as in particulate of CHOD1 and CHOD2 cells,
512 M β CD rather inhibits H₂O₂ generation (not shown).

513

514 4.c) Ionic requirements: Calcium

515 DUOX enzymes contain two intracellular EF hands. In acellular particulate systems
516 their activity is strictly dependent on the presence of Ca⁺⁺ (Deme et al., 1985). In the four
517 experimental systems used, prolonged incubation (2 hours) in the absence of Ca⁺⁺ and in the
518 presence of EGTA 0.1 mM completely suppressed basal H₂O₂ generation, and H₂O₂
519 generation stimulated by TSH, fluoride, ionomycin and increased pH=8 (not shown). In pig
520 thyroid slices, a preincubation and a incubation without Ca⁺⁺ are required to observe an
521 almost complete inhibition (Fig. 8). This delay is compatible with the accepted model
522 according to which the effect of Ca⁺⁺ bears on the intracellular EF hands of DUOX rather than
523 on the extracellular part of the enzymes. A smaller but similar effect is observed in slices
524 incubated 45 min in the absence of Ca⁺⁺ (Fig. 9). Thus in intact cells also, DUOX activity is
525 strictly dependent on intracellular calcium. Interestingly, in CHOD1 and CHOD2 cells, Mn⁺⁺
526 (1.45 mM) alone, in the absence of Ca⁺⁺, had a stronger stimulatory effect than Ca⁺⁺ 1.45 mM
527 on H₂O₂ generation, suggesting a direct effect on the enzyme (CHOD1 : no Ca⁺⁺ 85 \pm 10,
528 Ca⁺⁺ 297 \pm 10, Mn⁺⁺ 351 \pm 8) (CHOD2 : no Ca⁺⁺ 366 \pm 7, Ca⁺⁺ 1277 \pm 30, Mn⁺⁺ 1910 \pm 14)
529 (ng per dish).

530

531 4.d) Effect of CO₂ and pH

532 According to the accepted schemes of NOX-DUOX functioning, the generation of $O_2^{\cdot-}$
533 at the outside of the membrane is linked to the oxidation of $NADPH_2$ and the release of one
534 H^+ inside the cell (Fischer, 2009). For DUOX, this would imply that the reaction should be
535 decreased by intracellular acidification and enhanced by alcalinization. Indeed, raising the pH
536 of the Hepes buffer in the incubation medium or incubation with bicarbonate buffer without
537 CO_2 atmosphere, increases H_2O_2 generation in pig and sheep thyroid slices, in PCC13,
538 CHOD1 and CHOD2 cells.

539 While CO_2 diffuses easily across membranes, HCO_3^- has to be pumped out (Cordat
540 and Casey, 2009). In a 5% CO_2 atmosphere, always used with the $NaHCO_3$ buffer at pH 7.4,
541 CO_2 which freely diffuses in the cell would acidify the intracellular pH contrary to
542 extracellular $NaHCO_3$. It greatly decreases H_2O_2 generation whereas $NaHCO_3$ or Hepes at
543 pH 8 enhance it (Fig. 10). For a similar extracellular pH, with $NaHCO_3$ buffer and 5% CO_2
544 atmosphere, the internal cell pH is markedly lower than with a Hepes buffer and air
545 atmosphere (Kimelberg and Walz, 1988).

546 NH_4Cl , with NH_3 as the diffusing molecule, has a transient stimulatory effect on H_2O_2
547 generation by pig slices (156 ± 6 vs 112 ± 7 ng/100mg). A similar enhancement by NH_4Cl of
548 iodide binding to proteins in dog thyroid slices had been observed (Unger et al., 1985). In all
549 the models, the effects of NaF, TPA and ionomycin and in thyroid cells (pig, PCC13), the
550 effects of TSH, were qualitatively conserved at pH 8 (not shown).

551

552 4.e) Effect of hyperosmolarity.

553 Hyperosmolarity, whether caused by addition of sucrose (150, 250 mM) or NaCl (50
554 to 150 mM), maximally stimulated H_2O_2 generation in PCC13 cells and pig slices (Fig. 11).
555 No supplementary effect of the usual stimulants (TSH, TPA, ionomycin, ...) was observed
556 (not shown). The effect was abolished in a medium deprived of Ca^{++} with EGTA 0.1 mM.

557 No effect on IP generation was observed (not shown). The effect was reversible. Indeed,
558 after a 45 min incubation in normal medium, basal H₂O₂ level was back to normal.

559

560 4.f) Effect of arachidonate.

561 It has been reported that arachidonate directly stimulates some NOX enzymes (Seifert
562 and Schultz, 1987). When tested on our models, arachidonate enhanced H₂O₂ generation in
563 pig thyroid slices, PCCI3, CHOD1 but not CHOD2 cells (Fig. 6). This stimulatory effect was
564 not inhibited by EGTA nor by cooling at 22°C (Fig. 6 and Fig. 9). It therefore does not result
565 from an activation of either the Gq-PLC cascade or a Ca⁺⁺ channel. This is compatible with a
566 direct effect on the enzymes. Indeed arachidonate greatly stimulates the generation of H₂O₂
567 by the particulate fraction of CHOD1 cells while that of CHOD2 cells is slightly inhibited
568 (Fig. 12).

569

570 **DISCUSSION**

571

572 Specialized functional systems are studied in a variety of experimental models: from
573 the more physiological to the purest and more simplified: in vivo in intact humans or animals,
574 in vitro in organ slices, in cultured cells, in enzyme expressing cell lines and in subcellular or
575 enzyme preparations (Dumont et al., 2002). The slice model has been defined operationally
576 (Fig. 1) with open follicles providing a direct access to intact thyrocyte apical border and
577 iodination taking place in the closed follicles, which at 20 µM iodide in the medium is limited
578 by H₂O₂ generation. A perfect parallelism in kinetics and concentration effect curves of
579 various stimulants on H₂O₂ generation, iodide organification and pentose phosphate pathway
580 activity had been previously observed in dog thyroid slices (Corvilain et al., 1991).

581 Thyroid cell primary cultures on filters are an alternative model. The cells are
582 polarized and have been used for the study of iodide transport (Nilsson et al., 1990) and
583 thyroglobulin endocytosis (van den Hove et al., 2007). They are simpler and also close to the
584 physiological *in vivo* model but they are reconstituted *in vitro* rather than kept in their original
585 structure and they lack the internal more physiological control of iodination in closed follicles
586 that the slices offer.

587 The mechanisms of the control of H_2O_2 generation have been studied using various *in*
588 *vitro* experimental models. We shall discuss the implications of the results first for thyroid
589 cell biology, then for the DUOX system itself. The results are synthesized in a general model
590 (Fig. 13).

591 The properties of the slices have allowed to answer a first question: the location in the
592 cell of the iodine derivative which exerts direct effects on the thyroid cells, such as the
593 inhibition of TSH signal transduction pathways and in some species a direct activation of
594 H_2O_2 generation. The latter effect links the generation of H_2O_2 to the supply of the substrate
595 of the system, iodide. Most of the effects of iodide are inhibited by drugs that block its uptake
596 (eg perchlorate) and by drugs that inhibit its oxidation by TPO (eg methimazole) which led to
597 the concept that these effects are mediated by an intrafollicular oxidized derivative of iodide
598 XI (Van Sande et al., 1975). A search for XI has demonstrated two iodinated lipids:
599 iodoheptadecanal and iodolactone (Panneels et al., 2009). The former regulates H_2O_2
600 generation and iodide oxidation in particulate preparations (Ohayon et al., 1994). The cellular
601 location of XI is unknown. The demonstration here that one effect of XI, i.e. the activation of
602 H_2O_2 generation in open follicles is inhibited by a thyroperoxidase inhibitor (methimazole)
603 but not by perchlorate shows that in an open system, iodide does not need any more to
604 penetrate the thyroid cell to generate XI, thus suggests that this generation takes place at the
605 apical border of the cell. The persistence of the effect shows that the intermediate HDA is not

606 diluted in the medium, i.e., that consonant with its lipid character (Panneels et al., 1994a;
607 Panneels et al., 1994b), it remains in the membrane as suggested before (Van Sande et al.,
608 1985). Indeed, no effect of the medium of slices incubated with iodide had been previously
609 observed on fresh dog thyroid slices incubated in that medium + methimazole (Van Sande et
610 al., 1985).

611 The presence and role of two DUOXes in the human thyroid remains mysterious as
612 the only congenital defect of the system leading to hypothyroidism involves DUOX2 (Ris-
613 Stalpers, 2006) and while DUOX1 but not DUOX2 is activated by the cAMP-PKA pathway
614 (Rigutto et al., 2009), H₂O₂ generation by human and pig thyroid slices is not. This suggests
615 a silencing of DUOX1 in pig as in human thyroid (Rigutto et al., 2009). Different tissues
616 localizations of DUOX1 and DUOX2 could reflect different operational conditions and roles.
617 While DUOX1 in tracheal mucosa is exposed to 20% O₂, DUOX2 in the intestinal mucosa
618 must be exposed to much lower O₂ concentrations. This fits well with the lower efficiency of
619 DUOX1 but not DUOX2 at 2% O₂. Certainly the expression of DUOX2 in the relatively
620 poorly oxygenated fetal thyroid would make sense.

621 TSH, and other thyroid activating agents, have been shown long ago to activate the
622 pentose phosphate pathway in the thyroid. As the activity of this pathway is regulated by the
623 oxidation of its product NADPH and as the coenzyme of DUOXes is NADPH, it had been
624 postulated that glucose metabolism through the pentose phosphate pathway is regulated by the
625 rate of NADPH oxidation by the DUOXes (Dumont, 1971). If this hypothesis is correct,
626 H₂O₂ generation should be dependent on the supply of glucose. Indeed, in pig and human
627 thyroid slices H₂O₂ is decreased by 80% in the absence of glucose in the medium. This effect
628 is lower in CHO and absent in PCCl3 cells i.e. in non physiological models.

629 Protection of the cell and its DNA against H₂O₂ is crucial for the long term survival of
630 the thyrocyte (7 years) (Coclet et al., 1989). Insufficiency of this protection has been

631 proposed as the cause for the high prevalence of thyroid nodules (Krohn et al., 2007; Ledent
632 et al., 1997; Song et al., 2007). Intracellular H_2O_2 is reduced both by catalase and glutathione
633 peroxidase. The latter pathway involves the oxidation of glutathione, itself reduced by the
634 NADPH generated by the pentose phosphate pathway. We had hypothesized (Dumont, 1971)
635 that the latter pathway was predominant. High concentrations of H_2O_2 (0.2 mM) increase
636 glucose oxidation by the pentose phosphate pathway in dog thyroid slices (Corvilain et al.,
637 1991). However, at rather high levels of added H_2O_2 in pig and human slices, deprivation of
638 glucose interfered much less with H_2O_2 disposal than the addition of NaN_3 a catalase
639 inhibitor. The slow disposal of added H_2O_2 in cell lines is also mostly accounted for by
640 catalase. Thus catalase represents the most efficient protector of the thyroid cell in the
641 presence of high level of H_2O_2 . Peroxisomes, which contain catalase, have indeed been
642 demonstrated in thyroid cells (Tice, 1974). Previous work on pig thyroid cells in culture,
643 arrived at the same conclusion but showed that at low levels of H_2O_2 the GSH peroxidase
644 system plays the major role (Bjorkman and Ekholm, 1995). Defective GSH peroxidase
645 explains the role of selenium deficiency in the thyroid destruction of endemic cretins
646 (Contempre et al., 1995). Thus glucose metabolism may be important for defense against
647 H_2O_2 , but the fraction of this metabolism accounted for by disposal of H_2O_2 is much lower
648 than the fraction used for its generation.

649 As in the absence of iodide, H_2O_2 has deleterious effects on cells, we postulated that
650 TPO, which we know is associated to active DUOXes in the plasma membrane (Song et al.,
651 2010b), might consume H_2O_2 even in the absence of iodide, i.e. have a catalase like effect.
652 However purified TPO, contrary to myeloperoxidase, has no such effect. On the other hand,
653 as expected, in the presence of iodide, TPO indeed consumed H_2O_2 . Contrary to the NOX
654 systems, the DUOX system in thyroid cells, as in transfected cells, generates H_2O_2 in the
655 absence of any stimulating agent. While such a constitutive H_2O_2 generation might make

656 physiological sense for mucosae keeping bacteria at bay (Botteaux et al., 2009), its role in
657 thyroid follicles deprived of iodide is less evident. Of course the stimulation of the system by
658 iodide in some species offers a partial response to that question. Contrary to our expectations
659 we found no evidence that the system is protected by a catalase like activity of TPO, which
660 only consumes H_2O_2 in the presence of iodide. Of course, in vivo, even in the absence of
661 iodide in the diet, there is always supply of iodide from the recirculation of the iodide derived
662 in the thyrocytes from deiodinated iodotyrosines released by thyroglobulin hydrolysis, and,
663 from the recirculation of iodide released by thyroid hormone deiodination in other organs
664 which is not lost in the urine.

665 The effects of extracellular signals on target cells reflect their mechanism of action
666 and the differentiation characteristics of the target cells. In this work, we have compared the
667 thyroid H_2O_2 generation in thyroid slices, in PCC13 cells, the available thyroid cell line closest
668 to physiology (Kimura et al., 2001), in DUOX1 and DUOX2 expressing CHO cells and in
669 particulates prepared from thyroid tissue or CHO stably transfected cells. The first model
670 conserves the tissue structure of the in vivo thyroid, the second has lost this structure but
671 conserves to a large extent its thyrocyte differentiation, and the third has no thyroid character
672 besides the expression of DUOX1 or DUOX2 at its plasma membrane. The comparison
673 should allow to distinguish intrinsic properties of the enzyme vs properties conferred by
674 thyroid differentiation and/or structure (Table 5). It defines 1) properties linked to the
675 structure and polarity of the cells such as the mechanism of action of iodide and the raft
676 dissolving effects of β MCD, 2) effects linked to cell differentiation such as the effect of TSH,
677 3) general effects on signal transduction such as those of ATP γ s, fluoride, hyperosmolarity
678 and cooling at 22°C, and 4) presumably direct effects on the H_2O_2 generating system, the
679 “thyroxisome”, such as the effects of pH, calcium, manganese and arachidonate (Table 3).
680 The direct ubiquitous targets of the Gq-PLC cascade and its Ca^{++} and diacylglycerol

681 intracellular signals, are activated in all cell types by their respective agonists ATP, TPA and
682 Ca^{++} ionophore. In conclusion, with regard to the thyroid, the only specific properties of the
683 physiologically structured thyrocytes in slices are the activation of H_2O_2 generation by M β CD
684 and by iodide at the level of the apical membrane. The former suggests that DUOXes
685 sequestered in the lipid rafts of this highly structured membrane, are inactive.

686 The pharmacological stimulants act with no significant delay and continuously over
687 two hours in all models. As shown before for TSH (Van Sande et al., 1977), after washing of
688 the cells, the effect of extracellular stimulants, TSH and ATP, disappeared rapidly
689 demonstrating immediate on/off signaling. On the other hand, the effect of TPA or
690 ionomycin persisted for some time, consistent with their intracellular action (Table 4).

691 NaF activated H_2O_2 generation in all models. The effect was delayed and prolonged
692 after washing of the cells, which suggests an intracellular action. In fact, NaF activated the Gq
693 phospholipase C cascade in all models and the concentration effect relations for intracellular
694 IP and extracellular H_2O_2 generation were parallel. The effect is not a direct effect on
695 DUOXes as it is not observed on the particulate enzyme. Thus fluoride is a useful
696 intracellular activator of the whole Gq-PLC cascade. This ion has been used extensively in
697 acellular systems to activate Gs and consequently adenylate cyclase (Gilman, 1987). Its effect
698 has been ascribed to the filling in Gs-GDP of the hole of the third phosphate group of Gs-
699 GTP. Presumably the same mechanism applies to Gq. NaF can therefore be a useful general
700 extracellular activator of the Gq PLC cascade.

701 Both DUOXes contain EF hands in their first intracellular loop. Moreover Ca^{++} is
702 required for the activity of the particulate enzyme (Deme et al., 1985). Similarly, in the four
703 models, Ca^{++} was shown to be absolutely required for enzyme activity and to modulate it up
704 to maximal levels, whatever the stimulus applied. The length of time required to achieve
705 maximal inhibition of H_2O_2 generation after Ca^{++} suppression, was longer for slices, showing

706 that intracellular and not extracellular Ca^{++} was required. This delay probably depends on the
707 level of intracellular Ca^{++} stores in the different models. This general modulation by
708 intracellular Ca^{++} is therefore a general property of the DUOX system itself.

709 DUOXes are membrane enzymes and as such their activity might be dependent on
710 membrane structure. We had previously shown that incubation at 22°C inhibits several
711 membrane parameters in thyroid cells such as TSH induced endocytosis of thyroglobulin
712 which was ascribed to membrane phase transition (Van Sande et al., 1978). In fact neither
713 basal H_2O_2 generation in the four model cell models used, nor enzyme activity of the
714 particulate enzymes were inhibited at 22°C . On the other hand, cooling to 22°C immediately
715 and completely abolished stimulated H_2O_2 and IP generation in the four models and for all the
716 extracellular stimuli used. The suppression of PLC cascade activation by NaF or hormones at
717 22°C would rather bear on phospholipase C than on G protein activation as adenylate cyclase
718 activation by TSH, cholera toxin and NaF in thyroid homogenate is not suppressed at 20°C
719 (Van Sande et al., 1979). Thus cooling at 22°C is a useful and innocuous experimental tool to
720 shut off the activation of the Gq-PLC cascade.

721 Methyl- β -cyclodextrin which traps membrane cholesterol and disrupts lipid rafts had a
722 strong stimulatory effect on H_2O_2 generation by the structured normal thyrocytes of slices but
723 not in the PCCI3, CHOD1 and CHOD2 cells. It has no stimulatory effect on IP generation.
724 In caveolin KO mice disruption of caveolae in the thyrocyte apical membrane, also leads to
725 higher H_2O_2 generation (Senou et al., 2009). This suggests that, as previously proposed, part
726 of the apical membrane DUOXes in the thyrocyte are sequestered and inactivated in lipid
727 rafts (Song et al., 2007).

728 The present concept of H_2O_2 generation by NOXes, whether inside secondary
729 lysosome or out of the cell, involves the prior generation of $\text{O}_2^{\cdot-}$ which is then converted to
730 H_2O_2 . This implies that the 2 hydrogens of NADPH_2 generate H^+ inside the cells (and

731 therefore acidification) and $O_2^{\cdot-}$ outside (Segal, 2008). The DUOXes on the contrary directly
732 generate H_2O_2 . In fact only immature forms of DUOXes, either inside the cells (Ameziane-
733 El-Hassani et al., 2005) or after reaching the plasma membrane with the wrong chaperone (eg.
734 DUOXA1 for DUOX2) generate $O_2^{\cdot-}$ (Morand et al., 2009; Zamproni et al., 2008). There is
735 therefore a question mark whether the electrical gradient generated by the NOXes also exist
736 for the DUOXes. Indeed acidification of the intracellular medium, through CO_2 diffusion, or
737 through extracellular pH, nearly abolishes H_2O_2 generation while alcalinization enhances it.
738 This suggests that DUOXes indeed generate exterior $O_2^{\cdot-}$ as an intermediate stage but
739 immediately reduce it. This would explain why superoxide dismutase barely inhibits H_2O_2
740 generation in particulate systems or in slices (Virion et al., 1984). The extracellular NH_2
741 terminal of DUOXes, homologous to thyroperoxidase could play this dismutase role.

742 The action of intracellular H^+ explains the effect of NH_4Cl , of high extracellular pH
743 and the lower H_2O_2 generation in cells incubated with bicarbonate buffer and 5% CO_2 versus
744 Hepes buffer at the same extracellular pH. This suggests that the thyroid cells, as leukocytes
745 and macrophages, require a mechanism to neutralize the effect of DUOX activity on
746 intracellular pH and that defects in this neutralization could give rise to iodination defects
747 (Fischer, 2009). The effect of intracellular pH and of H^+ generation in the cell, as in the case
748 of the NOX systems, is exhibited in the four experimental models and would therefore be a
749 property of the DUOXes themselves.

750 Arachidonate activates H_2O_2 generation in the 4 models. As it is not inhibited by
751 EGTA, the effect does not result from activation of the Gq-PLC cascade. Arachidonate
752 stimulates DUOX1 in particulates of CHOD1 cells. It could therefore be a direct probe of the
753 DUOX1 enzyme itself, in models in which the enzyme is exposed, such as slices open
754 follicles and cells in culture. This suggests that DUOX1, even if not necessary, is capable to
755 contribute to thyroid H_2O_2 generation.

756 On the basis of the results presented in this article we propose a mechanistic scheme of
757 the control of H_2O_2 generation and thyroid hormone synthesis by the thyrocyte that could be
758 useful in interpreting the physiopathology of the organ and provide tools for the investigation,
759 in near physiological conditions, of the thyroid hormone synthesizing machinery (Fig. 13).

760 With regard to H_2O_2 generation, interesting pharmacological, not cell specific, tools
761 allowing to reversibly modulate the signal transduction cascade controlling H_2O_2 generation
762 have been demonstrated: some activating the Gq-PLC cascade directly (NaF) or through an
763 ubiquitous receptor (ATP), one inhibiting it (cooling), some mimicking the downstream
764 effects of this cascade (ionomycin, phorbol esters), some acting on the intracellular pH
765 (alkaline pH, hyperosmolarity) and some acting presumably on the apical membrane (M β CD)
766 or directly on the enzymes (arachidonate). It would be interesting to apply these tools and
767 concepts to other tissues such as the aerial and digestive mucosae where the DUOXes operate,
768 and even to other NOXes.

Reference List

- 769
770
771 Ameziane-El-Hassani, R., S. Morand, J. L. Boucher, Y. M. Frapart, D. Apostolou, D.
772 Agnandji, S. Gnidehou, R. Ohayon, M. S. Noel-Hudson, J. Francon, K. Lalaoui, A.
773 Virion, and C. Dupuy. 2005. Dual oxidase-2 has an intrinsic Ca²⁺-dependent H₂O₂-
774 generating activity. *J. Biol. Chem* 280:30046-30054.
- 775 Benard, B. and J. Brault. 1971. [Production of peroxide in the thyroid]. *Union Med. Can.*
776 100:701-705.
- 777 Berridge, M. J. 1983. Rapid accumulation of inositol trisphosphate reveals that agonists
778 hydrolyse polyphosphoinositides instead of phosphatidylinositol. *Biochem. J.*
779 212:849-858.
- 780 Bjorkman, U. and R. Ekholm. 1984. Generation of H₂O₂ in isolated porcine thyroid follicles.
781 *Endocrinology* 115:392-398.
- 782 Bjorkman, U. and R. Ekholm. 1992. Hydrogen peroxide generation and its regulation in
783 FRTL-5 and porcine thyroid cells. *Endocrinology* 130:393-399.
- 784 Bjorkman, U. and R. Ekholm. 1995. Hydrogen peroxide degradation and glutathione
785 peroxidase activity in cultures of thyroid cells. *Mol. Cell Endocrinol.* 111:99-107.
- 786 Botteaux, A., C. Hoste, J. E. Dumont, Van Sande J., and A. Allaoui. 2009. Potential role of
787 Noxes in the protection of mucosae: H₂O₂ as a bacterial repellent. *Microbes.*
788 *Infect.* 11:537-544.
- 789 Caillou, B., C. Dupuy, L. Lacroix, M. Nocera, M. Talbot, R. Ohayon, D. Deme, J. M. Bidart,
790 M. Schlumberger, and A. Virion. 2001. Expression of reduced nicotinamide adenine
791 dinucleotide phosphate oxidase (ThoX, LNOX, Duox) genes and proteins in human
792 thyroid tissues. *J. Clin. Endocrinol. Metab* 86:3351-3358.
- 793 Coclet, J., F. Foureau, P. Ketelbant, P. Galand, and J. E. Dumont. 1989. Cell population
794 kinetics in dog and human adult thyroid. *Clin. Endocrinol. (Oxf)* 31:655-665.
- 795 Contempre, B., J. E. Dumont, J. F. Denef, and M. C. Many. 1995. Effects of selenium
796 deficiency on thyroid necrosis, fibrosis and proliferation: a possible role in
797 myxoedematous cretinism. *Eur. J. Endocrinol.* 133:99-109.
- 798 Cordat, E. and J. R. Casey. 2009. Bicarbonate transport in cell physiology and disease.
799 *Biochem. J.* 417:423-439.
- 800 Corvilain, B., L. Collyn, J. Van Sande, and J. E. Dumont. 2000. Stimulation by iodide of
801 H₂O₂ generation in thyroid slices from several species. *Am. J. Physiol Endocrinol.*
802 *Metab* 278:E692-E699.
- 803 Corvilain, B., E. Laurent, M. Lecomte, J. Van Sande, and J. E. Dumont. 1994. Role of the
804 cyclic adenosine 3',5'-monophosphate and the phosphatidylinositol-Ca²⁺ cascades in
805 mediating the effects of thyrotropin and iodide on hormone synthesis and secretion in
806 human thyroid slices. *J. Clin. Endocrinol. Metab* 79:152-159.

- 807 Corvilain, B., J. Van Sande, and J. E. Dumont. 1988. Inhibition by iodide of iodide binding to
808 proteins: the "Wolff-Chaikoff" effect is caused by inhibition of H₂O₂ generation.
809 *Biochem. Biophys. Res. Commun.* 154:1287-1292.
- 810 Corvilain, B., J. Van Sande, E. Laurent, and J. E. Dumont. 1991. The H₂O₂-generating
811 system modulates protein iodination and the activity of the pentose phosphate pathway
812 in dog thyroid. *Endocrinology* 128:779-785.
- 813 Costa, M. J., Y. Song, P. Macours, C. Massart, M. C. Many, S. Costagliola, J. E. Dumont,
814 Van Sande J., and V. Vanvooren. 2004. Sphingolipid-cholesterol domains (lipid rafts)
815 in normal human and dog thyroid follicular cells are not involved in thyrotropin
816 receptor signaling. *Endocrinology* 145:1464-1472.
- 817 Czarnocka, B., J. Ruf, M. Ferrand, P. Carayon, and S. Lissitzky. 1985. Purification of the
818 human thyroid peroxidase and its identification as the microsomal antigen involved in
819 autoimmune thyroid diseases. *FEBS Lett.* 190:147-152.
- 820 De Deken, X., D. Wang, M. C. Many, S. Costagliola, F. Libert, G. Vassart, J. E. Dumont, and
821 F. Miot. 2000. Cloning of two human thyroid cDNAs encoding new members of the
822 NADPH oxidase family. *J. Biol. Chem* 275:23227-23233.
- 823 Deleu, S., Y. Allory, A. Radulescu, I. Pirson, N. Carrasco, B. Corvilain, I. Salmon, B. Franc,
824 J. E. Dumont, J. Van Sande, and C. Maenhaut. 2000. Characterization of autonomous
825 thyroid adenoma: metabolism, gene expression, and pathology. *Thyroid* 10:131-140.
- 826 Deme, D., A. Virion, N. A. Hammou, and J. Pommier. 1985. NADPH-dependent generation
827 of H₂O₂ in a thyroid particulate fraction requires Ca²⁺. *FEBS Lett.* 186:107-110.
- 828 Driessens, N., S. Versteheyhe, C. Ghaddhab, A. Burniat, X. De Deken, Van Sande J., J. E.
829 Dumont, F. Miot, and B. Corvilain. 2009. Hydrogen peroxide induces DNA single-
830 and double-strand breaks in thyroid cells and is therefore a potential mutagen for this
831 organ. *Endocr. Relat Cancer* 16:845-856.
- 832 Dumont, J. E. 1971. The action of thyrotropin on thyroid metabolism. *Vitam. Horm.* 29:287-
833 412.
- 834 Dumont, J. E., S. Dremier, I. Pirson, and C. Maenhaut. 2002. Cross signaling, cell specificity,
835 and physiology. *Am. J. Physiol Cell Physiol* 283:C2-28.
- 836 Ekholm, R. and U. Bjorkman. 1984. Localization of iodine binding in the thyroid gland in
837 vitro. *Endocrinology* 115:1558-1567.
- 838 Fischer, H. 2009. Mechanisms and function of DUOX in epithelia of the lung. *Antioxid.*
839 *Redox. Signal.* 11:2453-2465.
- 840 Gilman, A. G. 1987. G proteins: transducers of receptor-generated signals. *Annu. Rev.*
841 *Biochem.* 56:615-649.
- 842 Graff, I., J. Mockel, E. Laurent, C. Erneux, and J. E. Dumont. 1987. Carbachol and sodium
843 fluoride, but not TSH, stimulate the generation of inositol phosphates in the dog
844 thyroid. *FEBS Lett.* 210:204-210.

- 845 Grasberger, H. and S. Refetoff. 2006. Identification of the maturation factor for dual oxidase.
846 Evolution of an eukaryotic operon equivalent. *J. Biol. Chem* 281:18269-18272.
- 847 Hoste, C., S. Rigutto, Van Vliet G., F. Miot, and X. De Deken. 2010. Compound
848 heterozygosity for a novel hemizygous missense mutation and a partial deletion
849 affecting the catalytic core of the H₂O₂-generating enzyme DUOX2 associated with
850 transient congenital hypothyroidism. *Hum. Mutat.* 31:E1304-E1319.
- 851 Kimelberg, H. K. and W. Walz. 1988. Ion Transport and Volume Measurements in Cell
852 Cultures. Pages 441-492 in *Neuromethods; The Neuronal Microenvironment*. A. A.
853 Boulton, G. B. Baker, and W. Walz eds. The Humana Press.
- 854 Kimura, T., K. A. Van, J. Golstein, A. Fusco, J. E. Dumont, and P. P. Roger. 2001.
855 Regulation of thyroid cell proliferation by TSH and other factors: a critical evaluation
856 of in vitro models. *Endocr. Rev.* 22:631-656.
- 857 Krohn, K., J. Maier, and R. Paschke. 2007. Mechanisms of disease: hydrogen peroxide, DNA
858 damage and mutagenesis in the development of thyroid tumors. *Nat. Clin. Pract.*
859 *Endocrinol. Metab* 3:713-720.
- 860 Ledent, C., J. F. Deneff, S. Cottechia, R. Lefkowitz, J. Dumont, G. Vassart, and M.
861 Parmentier. 1997. Costimulation of adenylyl cyclase and phospholipase C by a mutant
862 alpha 1B-adrenergic receptor transgene promotes malignant transformation of thyroid
863 follicular cells. *Endocrinology* 138:369-378.
- 864 Magnusson, R. P. and A. Taurog. 1983. Iodide-dependent catalytic activity of thyroid
865 peroxidase and lactoperoxidase. *Biochem. Biophys. Res. Commun.* 112:475-481.
- 866 Michot, J. L., D. Deme, A. Virion, and J. Pommier. 1985. Relation between thyroid
867 peroxidase, H₂O₂ generating system and NADPH-dependent reductase activities in
868 thyroid particulate fractions. *Mol. Cell Endocrinol.* 41:211-221.
- 869 Milenkovic, M., X. De Deken, L. Jin, M. De Felice, R. Di Lauro, J. E. Dumont, B. Corvilain,
870 and F. Miot. 2007. Duox expression and related H₂O₂ measurement in mouse thyroid:
871 onset in embryonic development and regulation by TSH in adult. *J. Endocrinol.*
872 192:615-626.
- 873 Morand, S., T. Ueyama, S. Tsujibe, N. Saito, A. Korzeniowska, and T. L. Leto. 2009. Duox
874 maturation factors form cell surface complexes with Duox affecting the specificity of
875 reactive oxygen species generation. *FASEB J.* 23:1205-1218.
- 876 Moreno, J. C., H. Bikker, M. J. Kempers, A. S. van Trotsenburg, F. Baas, J. J. de Vijlder, T.
877 Vulsma, and C. Ris-Stalpers. 2002. Inactivating mutations in the gene for thyroid
878 oxidase 2 (THOX2) and congenital hypothyroidism. *N. Engl. J. Med.* 347:95-102.
- 879 Neve, P. and J. E. Dumont. 1970. Effects in vitro of thyrotropin, cyclic 3',5'-AMP, dibutyryl
880 cyclic 3',5'-AMP, and prostaglandin E1 on the ultrastructure of dog thyroid slices.
881 *Exp. Cell Res.* 63:285-292.
- 882 Nilsson, M., U. Bjorkman, R. Ekholm, and L. E. Ericson. 1990. Iodide transport in primary
883 cultured thyroid follicle cells: evidence of a TSH-regulated channel mediating iodide

- 884 efflux selectively across the apical domain of the plasma membrane. *Eur. J. Cell Biol.*
885 52:270-281.
- 886 Ohayon, R., J. M. Boeynaems, J. C. Braekman, H. Van den Bergen, Y. Gorin, and A. Virion.
887 1994. Inhibition of thyroid NADPH-oxidase by 2-iodohexadecanal in a cell-free
888 system. *Mol. Cell Endocrinol.* 99:133-141.
- 889 Pachucki, J., D. Wang, D. Christophe, and F. Miot. 2004. Structural and functional
890 characterization of the two human ThOX/Duox genes and their 5'-flanking regions.
891 *Mol. Cell Endocrinol.* 214:53-62.
- 892 Panneels, V., G. Juvenal, J. M. Boeynaems, J. E. Dumont, and J. Van Sande. 2009. Iodide
893 effects on the thyroid : Biochemical, physiological, pharmacological and clinical
894 effects of iodide in the thyroid. Pages 303-314 in *Comprehensive Handbook of iodine.*
895 Victor R.Preedy, Gerard N.Burrow, and Ronald Watson eds. Oxford Academic Press.
- 896 Panneels, V., H. Van den Bergen, C. Jacoby, J. C. Braekman, Van Sande J., J. E. Dumont,
897 and J. M. Boeynaems. 1994a. Inhibition of H₂O₂ production by iodoaldehydes in
898 cultured dog thyroid cells. *Mol. Cell Endocrinol.* 102:167-176.
- 899 Panneels, V., Van Sande J., H. Van den Bergen, C. Jacoby, J. C. Braekman, J. E. Dumont,
900 and J. M. Boeynaems. 1994b. Inhibition of human thyroid adenylyl cyclase by 2-
901 iodoaldehydes. *Mol. Cell Endocrinol.* 106:41-50.
- 902 Pohlenz, J., L. Duprez, R. E. Weiss, G. Vassart, S. Refetoff, and S. Costagliola. 2000. Failure
903 of membrane targeting causes the functional defect of two mutant sodium iodide
904 symporters. *J. Clin. Endocrinol. Metab* 85:2366-2369.
- 905 Raspe, E., G. Andry, and J. E. Dumont. 1989. Adenosine triphosphate, bradykinin, and
906 thyrotropin-releasing hormone regulate the intracellular Ca²⁺ concentration and the
907 45Ca²⁺ efflux of human thyrocytes in primary culture. *J. Cell Physiol* 140:608-614.
- 908 Raspe, E., E. Laurent, G. Andry, and J. E. Dumont. 1991. ATP, bradykinin, TRH and TSH
909 activate the Ca(2+)-phosphatidylinositol cascade of human thyrocytes in primary
910 culture. *Mol. Cell Endocrinol.* 81:175-183.
- 911 Raspe, E., P. P. Roger, and J. E. Dumont. 1986. Carbamylcholine, TRH, PGF₂ alpha and
912 fluoride enhance free intracellular Ca⁺⁺ and Ca⁺⁺ translocation in dog thyroid cells.
913 *Biochem. Biophys. Res. Commun.* 141:569-577.
- 914 Rigutto, S., C. Hoste, J. E. Dumont, B. Corvilain, F. Miot, and X. De Deken. 2007. Duox1 is
915 the main source of hydrogen peroxide in the rat thyroid cell line PCC13. *Exp. Cell Res.*
916 313:3892-3901.
- 917 Rigutto, S., C. Hoste, H. Grasberger, M. Milenkovic, D. Communi, J. E. Dumont, B.
918 Corvilain, F. Miot, and X. De Deken. 2009. Activation of dual oxidases Duox1 and
919 Duox2: differential regulation mediated by camp-dependent protein kinase and protein
920 kinase C-dependent phosphorylation. *J. Biol. Chem* 284:6725-6734.
- 921 Ris-Stalpers, C. 2006. Physiology and pathophysiology of the DUOXes. *Antioxid. Redox.*
922 *Signal.* 8:1563-1572.

- 923 Segal, A. W. 2008. The function of the NADPH oxidase of phagocytes and its relationship to
924 other NOXs in plants, invertebrates, and mammals. *Int. J. Biochem. Cell Biol.* 40:604-
925 618.
- 926 Seifert, R. and G. Schultz. 1987. Fatty-acid-induced activation of NADPH oxidase in plasma
927 membranes of human neutrophils depends on neutrophil cytosol and is potentiated by
928 stable guanine nucleotides. *Eur. J. Biochem.* 162:563-569.
- 929 Senou, M., M. J. Costa, C. Massart, M. Thimmesch, C. Khalifa, S. Poncin, M. Boucquey, A.
930 C. Gerard, J. N. Audinot, C. Dessy, J. Ruf, O. Feron, O. Devuyst, Y. Guiot, J. E.
931 Dumont, J. Van Sande, and M. C. Many. 2009. Role of caveolin-1 in thyroid
932 phenotype, cell homeostasis, and hormone synthesis: in vivo study of caveolin-1
933 knockout mice. *Am. J. Physiol Endocrinol. Metab* 297:E438-E451.
- 934 Song, Y., N. Driessens, M. Costa, X. De Deken, V. Detours, B. Corvilain, C. Maenhaut, F.
935 Miot, J. Van Sande, M. C. Many, and J. E. Dumont. 2007. Roles of hydrogen peroxide
936 in thyroid physiology and disease. *J. Clin. Endocrinol. Metab* 92:3764-3773.
- 937 Song, Y., C. Massart, V. Chico-Galdo, L. Jin, V. De Maertelaer, C. Decoster, J. E. Dumont,
938 and J. Van Sande. 2010a. Species specific thyroid signal transduction: conserved
939 physiology, divergent mechanisms. *Mol. Cell Endocrinol.* 319:56-62.
- 940 Song, Y., J. Ruf, P. Lothaire, D. Dequanter, G. Andry, E. Willemse, J. E. Dumont, Van Sande
941 J., and X. De Deken. 2010b. Association of duoxes with thyroid peroxidase and its
942 regulation in thyrocytes. *J. Clin. Endocrinol. Metab* 95:375-382.
- 943 Tice, L. W. 1974. Effects of hypophysectomy and TSH replacement on the ultrastructural
944 localization of thyroperoxidase. *Endocrinology* 95:421-433.
- 945 Unger, J., P. Ketelbant, and J. E. Dumont. 1985. Inhibition by lysosomotropic amines of dog
946 thyroid secretion in vitro. *Endocrinology* 116:958-965.
- 947 van den Hove, M. F., K. Croizet-Berger, D. Tyteca, C. Selvais, P. de Diesbach, and P. J.
948 Courtoy. 2007. Thyrotropin activates guanosine 5'-diphosphate/guanosine 5'-
949 triphosphate exchange on the rate-limiting endocytic catalyst, Rab5a, in human
950 thyrocytes in vivo and in vitro. *J. Clin. Endocrinol. Metab* 92:2803-2810.
- 951 Van Sande, J., P. Cochaux, and J. E. Dumont. 1985. Further characterization of the iodide
952 inhibitory effect on the cyclic AMP system in dog thyroid slices. *Mol. Cell*
953 *Endocrinol.* 40:181-192.
- 954 Van Sande, J. and J. E. Dumont. 1973. Effects of thyrotropin, prostaglandin E1 and iodide on
955 cyclic 3',5'-AMP concentration in dog thyroid slices. *Biochim. Biophys. Acta*
956 313:320-328.
- 957 Van Sande, J., G. Grenier, C. Willems, and J. E. Dumont. 1975. Inhibition by iodide of the
958 activation of the thyroid cyclic 3',5'-AMP system. *Endocrinology* 96:781-786.
- 959 Van Sande, J., P. Ketelbant-Balasse, G. Grenier, and J. E. Dumont. 1978. Uncoupling by
960 cooling of secretion and adenosine 3',5'-monophosphate accumulation in stimulated
961 dog thyroid slices. *Endocrinology* 102:576-581.

- 962 Van Sande, J., R. Pochet, and J. E. Dumont. 1979. Dissociation by cooling of hormone and
963 cholera toxin activation of adenylate cyclase in intact cells. *Biochim. Biophys. Acta*
964 585:282-292.
- 965 Van Sande, J., S. Swillens, and J. E. Dumont. 1977. Adenosine 3':5'-monophosphate
966 metabolism and turnover in dog thyroid slices. *Eur. J. Biochem.* 72:241-246.
- 967 Virion, A., J. L. Michot, D. Deme, J. Kaniewski, and J. Pommier. 1984. NADPH-dependent
968 H₂O₂ generation and peroxidase activity in thyroid particular fraction. *Mol. Cell*
969 *Endocrinol.* 36:95-105.
- 970 Weyemi, U., B. Caillou, M. Talbot, R. Ameziane-El-Hassani, L. Lacroix, O. Lagent-
971 Chevallier, A. Al Ghuzlan, D. Roos, J. M. Bidart, A. Virion, M. Schlumberger, and C.
972 Dupuy. 2010. Intracellular expression of reactive oxygen species-generating NADPH
973 oxidase NOX4 in normal and cancer thyroid tissues. *Endocr. Relat Cancer* 17:27-37.
- 974 Willems, C., J. Berberof-van Sande, and J. E. Dumont. 1972. Inhibition of thyroid secretion
975 by sodium fluoride in vitro. *Biochim. Biophys. Acta* 264:197-204.
- 976 Zamproni, I., H. Grasberger, F. Cortinovis, M. C. Vigone, G. Chiumello, S. Mora, K. Onigata,
977 L. Fugazzola, S. Refetoff, L. Persani, and G. Weber. 2008. Biallelic inactivation of the
978 dual oxidase maturation factor 2 (DUOXA2) gene as a novel cause of congenital
979 hypothyroidism. *J. Clin. Endocrinol. Metab* 93:605-610.
980
981

982 **FIGURE LEGENDS**

983 **Figure 1**

984 Schematic representation of a thyroid slice with its closed follicles inside, where the PBI
985 (Protein Bound Iodide) is formed thanks to the presence of I, H₂O₂ and thyroglobulin (TG) in
986 the lumen, and with its open follicles from which the H₂O₂ formed at the apical border is
987 immediately trapped by Homovanillic Acid (HVA) and Horse Radish Peroxidase (HRP)
988 reaction to form fluorescent HVA [(HVA)₂*].

989

990 **Figure 2**

991 Kinetics of TPA, ionomycin and NaF action on H₂O₂ production by pig thyroid slices.

992 ---●--- Control; ---◇--- TPA 5 μM; ---▲--- Ionomycin 1 μM; ---■--- NaF 10 mM

993 The preincubation lasted 60 min, the incubation with the various agents lasted from 5 to 120
994 min. TSH not tested in this experiment.

995

996 **Figure 3**

997 Effect of ClO₄⁻, a blocker of iodide transport by NIS or methimazole, a blocker of iodide
998 oxidation by TPO, on the stimulatory effect of iodide on H₂O₂ production by pig thyroid
999 slices. The preincubation in KRH medium lasted 1h. The incubation in KRH medium
1000 supplemented with KI 10⁻⁵ M, ± methimazole (Meth.) 10⁻⁴ M or ClO₄⁻ 10⁻⁴ M, lasted 90 min,
1001 in the presence of HVA and peroxidase.

1002

1003 **Figure 4**

1004 Effect of glucose deprived medium on H₂O₂ production by pig thyroid slices. The
1005 preincubation ± glucose lasted 1h. The incubation ± glucose and the test agents lasted 1h.

1006 Iono: Ionomycin. KRH α glucose : KRH without glucose

1007

1008 **Figure 5**

1009 Effect of glucose deprived medium on exogenously added H₂O₂ degradation by pig thyroid
1010 slices. The preincubation ± glucose lasted 1h. The incubation ± glucose, with H₂O₂ (2x10⁻⁵
1011 M), and NaN₃ (33 μM) lasted 5, 10 or 30 min. The slices were then pulled out of the medium
1012 and HVA + HRP were added to assay the amount of H₂O₂ left undegraded.

1013 □: Control; ■: NaN₃ 33 μM.

1014

1015 **Figure 6**

1016 Effect of cooling on H₂O₂ production by resting or stimulated pig thyroid slices. The slices
1017 were preincubated 1h at 37°C, then incubated for 45 min, at 37°C or 22°C with or without the
1018 various agonists.

1019 Arach.: Arachidonic acid; Iono.: Ionomycin

1020

1021 **Figure 7**

1022 Effect of cooling on MβCD stimulatory action on H₂O₂ production by pig thyroid slices. The
1023 preincubation ± 10 mM MβCD lasted 30 min at 37°C. The incubations, without MβCD,
1024 lasted 45 min, at 37°C or 22°C.

1025

1026 **Figure 8**

1027 Effect of Ca⁺⁺ depletion, in the preincubation medium, or the incubation medium, or both, on
1028 H₂O₂ production by resting or TSH stimulated pig thyroid slices. TSH: 10 mU/ml; normal:
1029 1,45 mM Ca⁺⁺; α Ca⁺⁺ EGTA: no added Ca⁺⁺ + EGTA 0,1 mM. The preincubation lasted 1h,
1030 the incubation lasted 30 min.

1031

1032 **Figure 9**

1033 Effect of Ca^{++} withdrawal on H_2O_2 production by resting or stimulated pig thyroid slices.
1034 After 1h preincubation in normal KRH medium (Ca^{++} : 1,45 mM), the slices were incubated
1035 45 min in a medium without added Ca^{++} , \pm an agonist (TSH: 10 mU/ml; TPA: 5 μM ; Arach:
1036 arachidonic acid 50 $\mu\text{g/ml}$). Effect of fluoride and pH8 studied in other experiments were
1037 also suppressed in the absence of Ca^{++} (not shown).

1038

1039 **Figure 10**

1040 Effect of pH and CO_2 on H_2O_2 production by pig thyroid slices. The various media used are:
1041 KRB medium at pH = 7.4 under an atmosphere of 95% O_2 – 5% CO_2 ; KRH medium at pH =
1042 7.4 air atmosphere; KRB medium pH = 8 air atmosphere and KRH medium pH = 8 air
1043 atmosphere. These media were present during the 30 min preincubation and the 1h incubation
1044 during which H_2O_2 produced was measured.

1045

1046 **Figure 11**

1047 Effect of Ca^{++} deprived medium on hyperosmolarity induced stimulation of H_2O_2 produced
1048 by pig thyroid slices. The preincubation in normal medium lasted 1h. The incubation, in the
1049 normal or hypertonic media, in the presence of 1,45 mM or deprived of Ca^{++} , lasted 30 min.

1050

1051 **Figure 12**

1052 Effect of arachidonic acid (AA) 50 $\mu\text{g/ml}$ on H_2O_2 production of particulate fractions of CHO
1053 D1 or CHO D2 cells (A.) and porcine thyroid slices (P Th) (B.). Particulate fractions were
1054 incubated with (\blacktriangle and \bullet) or without (\triangle and \circ) arachidonic acid (50 $\mu\text{g/ml}$) and H_2O_2
1055 production was recorded over 1 hour.

1056

1057 **Figure 13**

1058 Mechanistic scheme of the control of H₂O₂ generation and thyroid hormone synthesis. TG:
1059 thyroglobulin; I⁻: iodide; TPO: thyroperoxidase; MβCD: methyl-β-cyclodextrine; PMA:
1060 phorbol myristate acetate; PLC: phospholipase C; DAG: diacylglycerol; PKC: protein kinase
1061 C; IP₃: inositol 1,4,5 triphosphate; ClO₄⁻: sodium perchlorate; NIS: Na⁺-I symporter; P₂YR:
1062 Purinergic P₂Y receptor; TSHR: TSH receptor; Gq: Gαq protein; G6P: glucose-6-phosphate;
1063 P5P: pentose-5-phosphate; GSH: glutathione reduced; GSSG: glutathione oxidized; GSH-Px:
1064 glutathione peroxidase; GSSG-RED: glutathione reductase; XI: iodinated organic compound
1065 (iodohexadecanal); X: non-iodinated form;  raft.

1066

1067 **TABLE LEGENDS**

1068

1069 **Table 1**

1070 ¹: 900 ng H₂O₂ were incubated in 1 ml medium ± catalase but without HVA and HRP. After
1071 1h, HVA 4,4x10⁻⁴ M and HRP 100 μg/ml were added for 20 min. H₂O₂ is expressed in ng/ml.

1072 ²: Competition between catalase and HRP for H₂O₂ produced by pig thyroid tissue. After 1h
1073 preincubation in KRH medium, the slices were transferred to fresh medium + HVA 4,4x10⁻⁴
1074 M, ± catalase, ± HRP, for another hour. For the point without HRP, the tissue was removed at
1075 the end of incubation and HVA 4,4x10⁻⁴ M and HRP 100 μg/ml were added for 20 minutes
1076 incubation. H₂O₂ is expressed in ng/100 mg tissue.

1077 ³: After 1h preincubation, the slices were incubated with radioiodide 1h ± catalase. PBI
1078 (protein bound iodide) is expressed as a percentage of total (TCA precipitable radioactivity in
1079 % of total iodide radioactivity in the slices).

1080 n.d. : not done

1081

1082 **Table 2**

1083 After 1h preincubation, the slices were incubated 1h in their respective medium to measure

1084 H₂O₂ production and PBI formation.

1085 PBI: Protein bound iodide expressed as a percentage of total iodide uptake.

1086

1087 **Table 3**

1088 Ic: Intact cells

1089 Ic general property: observed in all intact cell models.

1090 n.d.: not done

1091

1092 **Table 4**

1093 n.d.: not done

1094 memb.: membrane

1095

1096 **Table 5**

1097 n.d.: not done

1098

1099

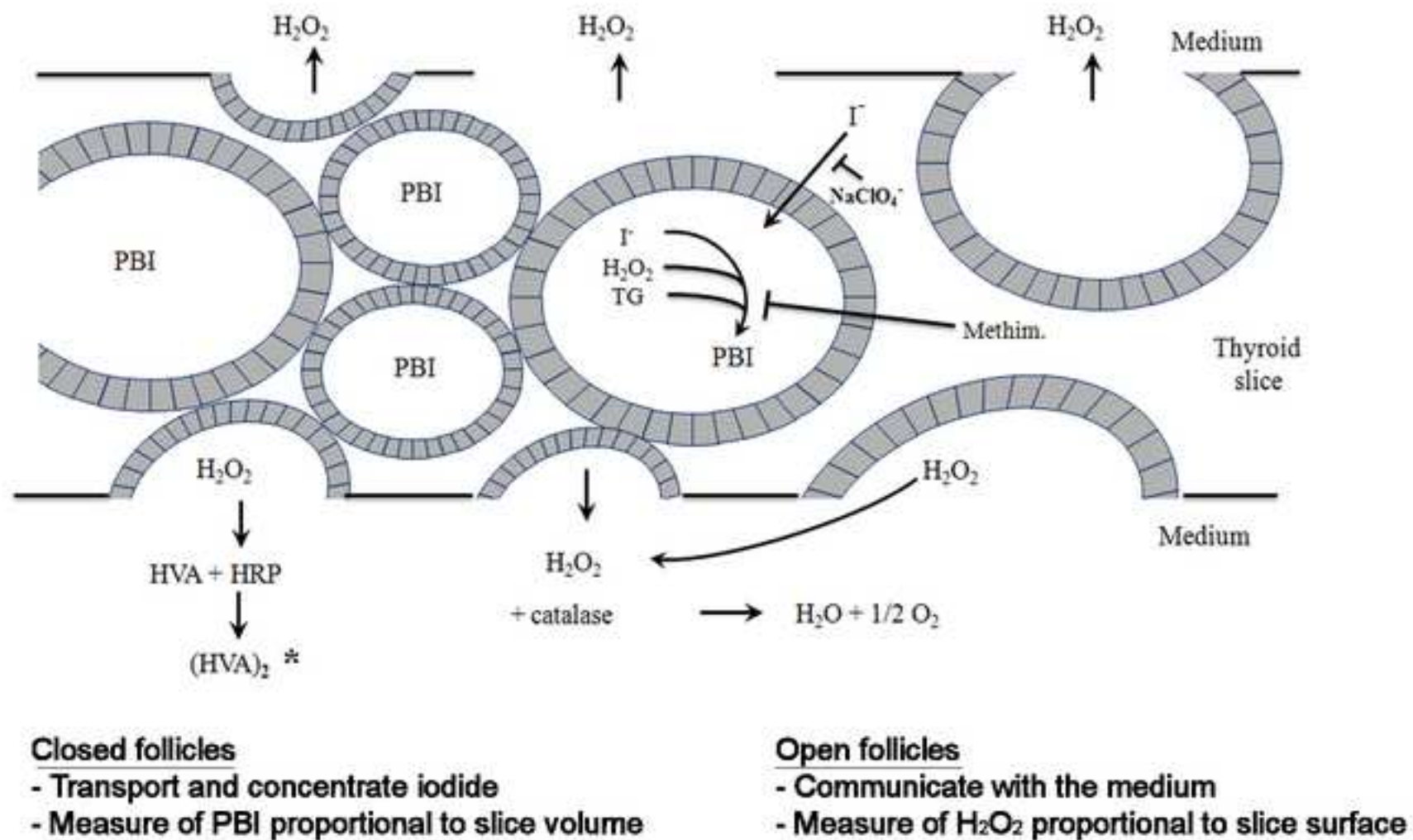

Figure 1

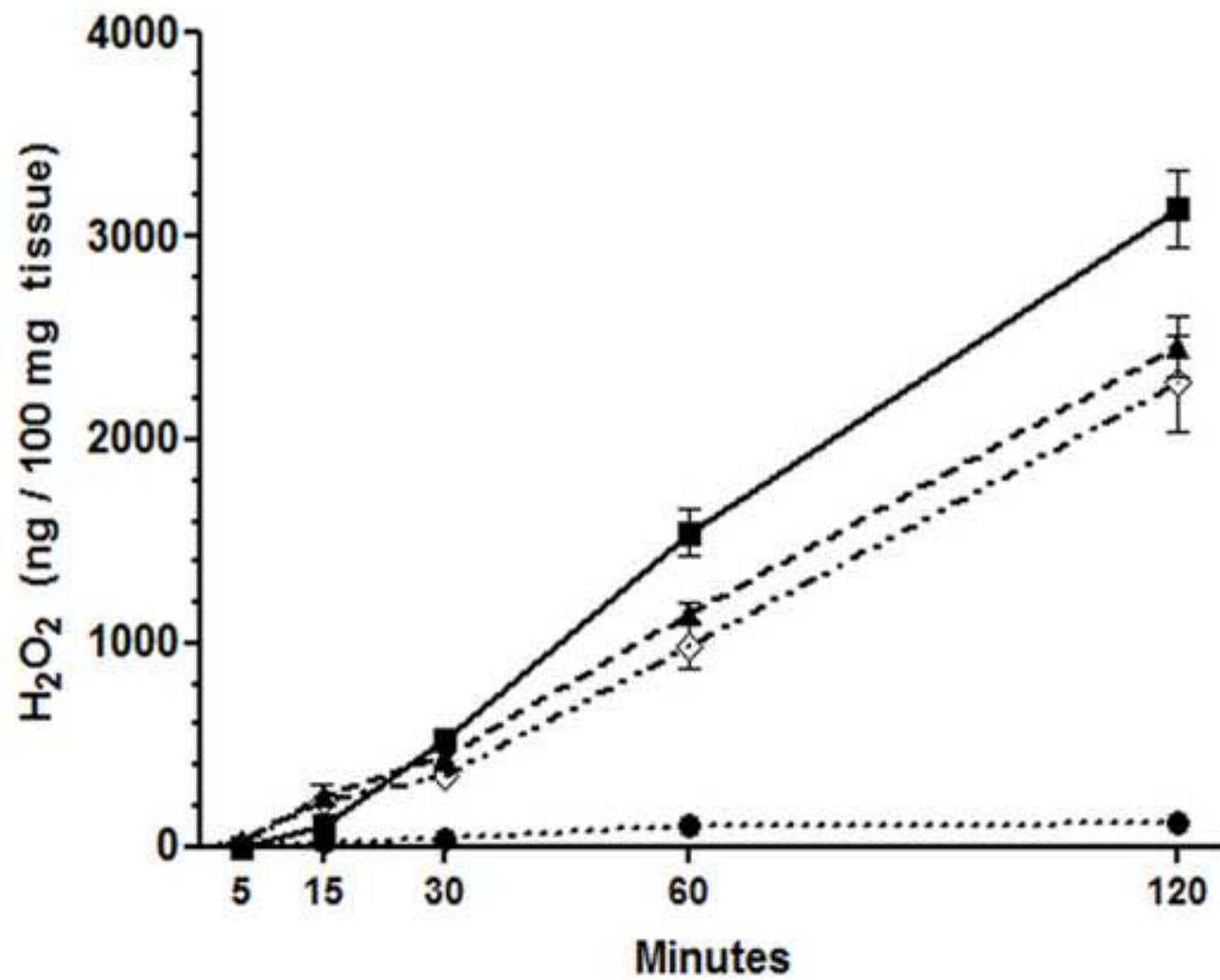

Figure 2

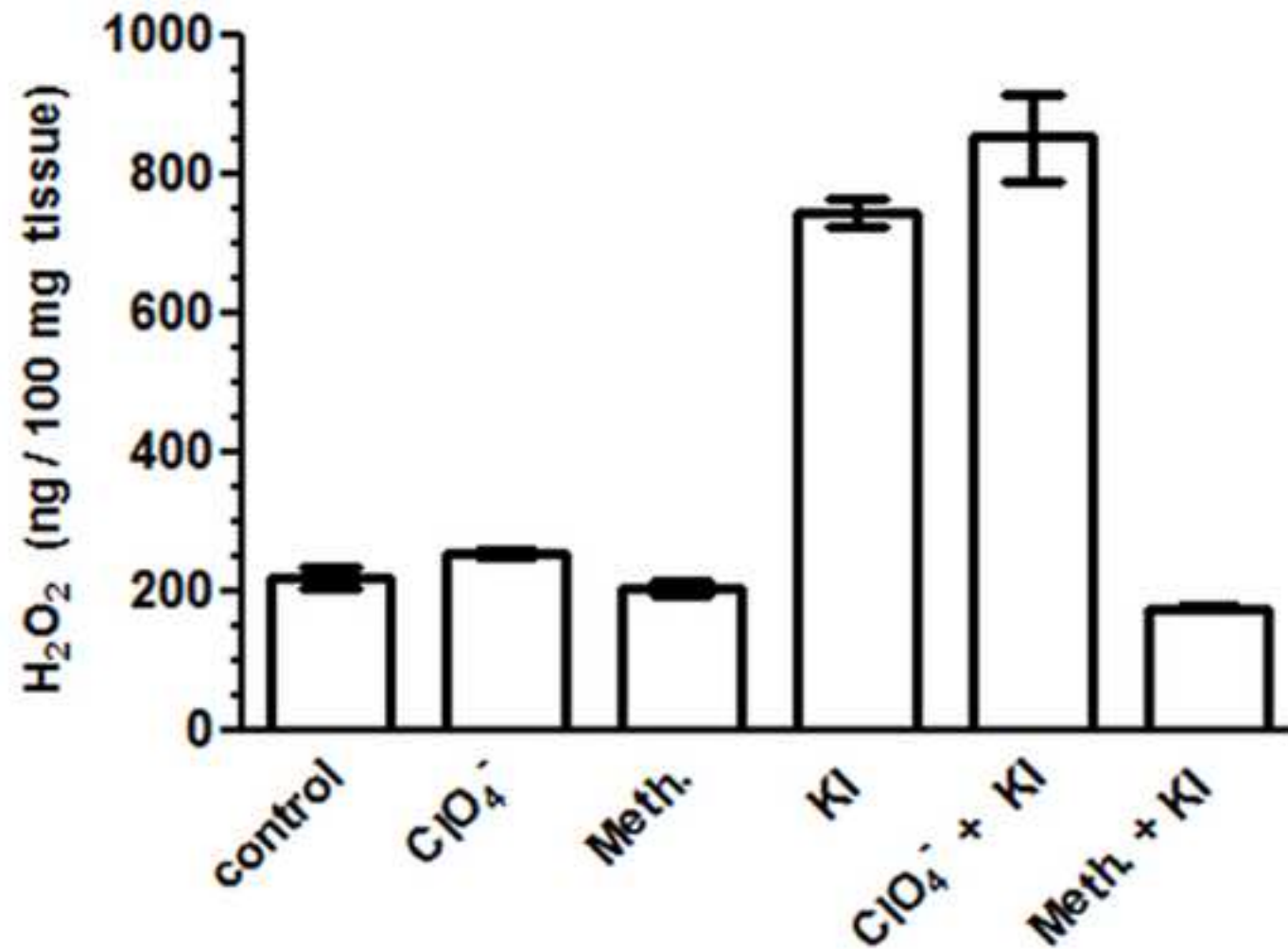

Figure 3

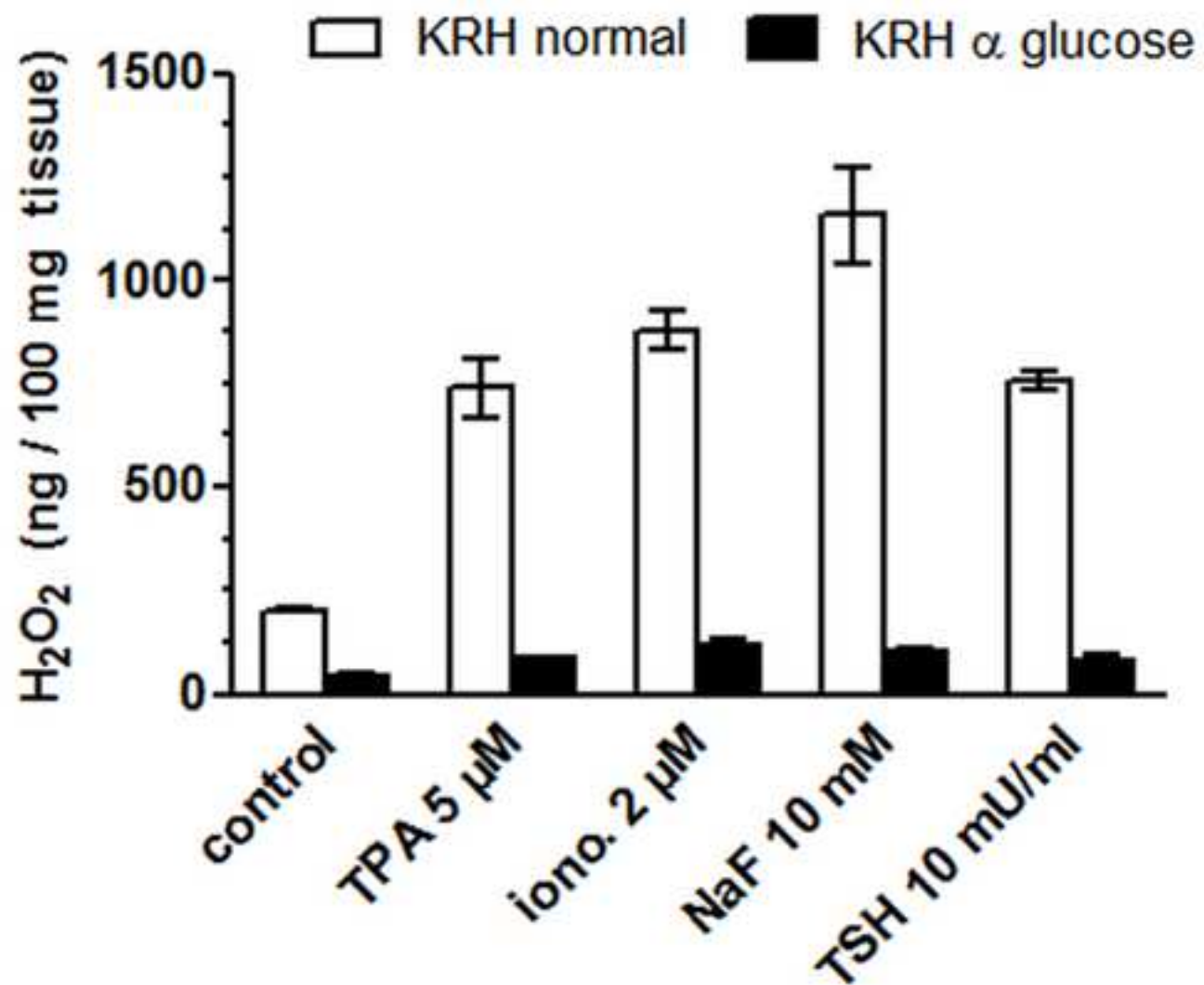

Figure 4

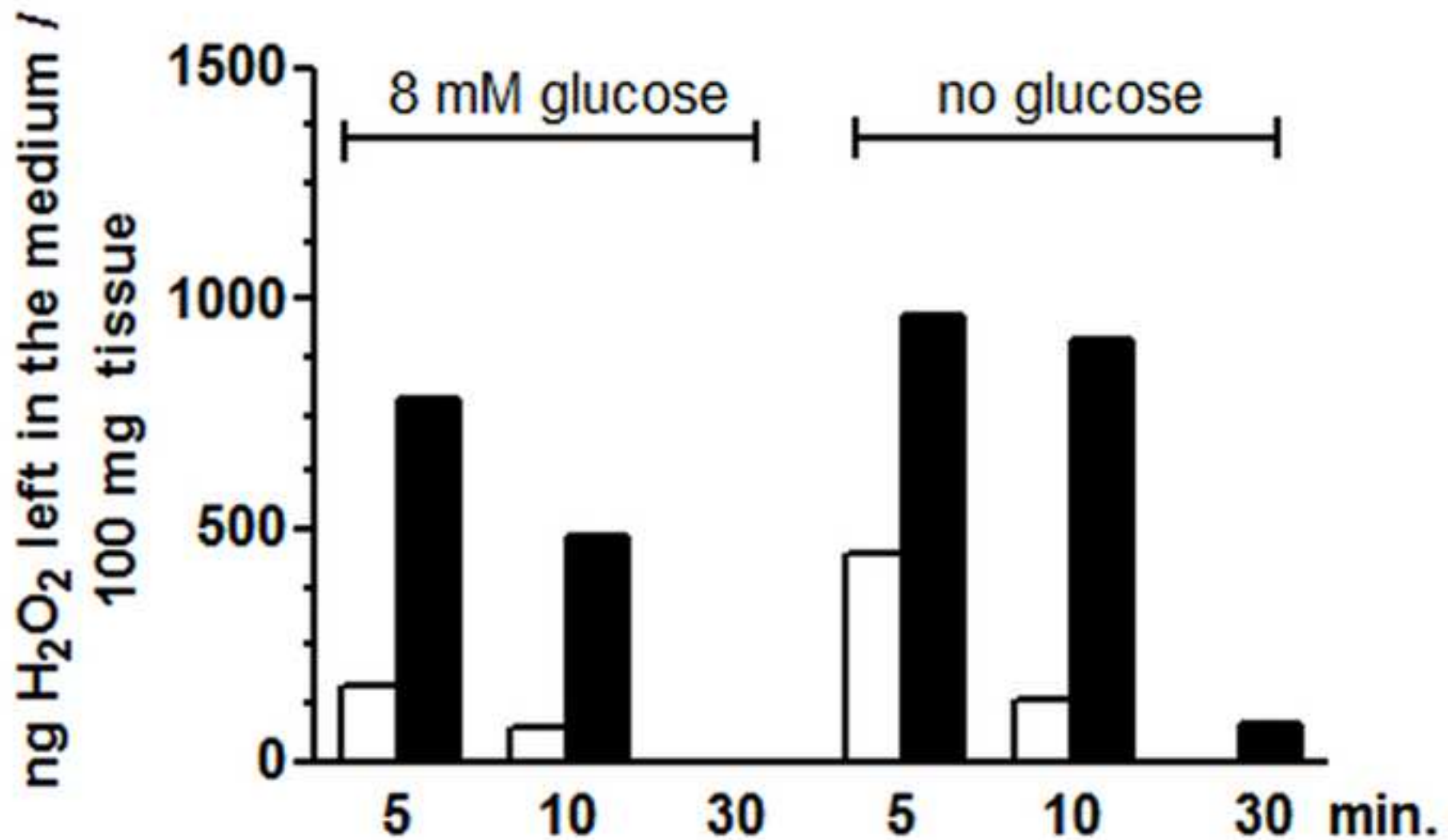

Figure 5

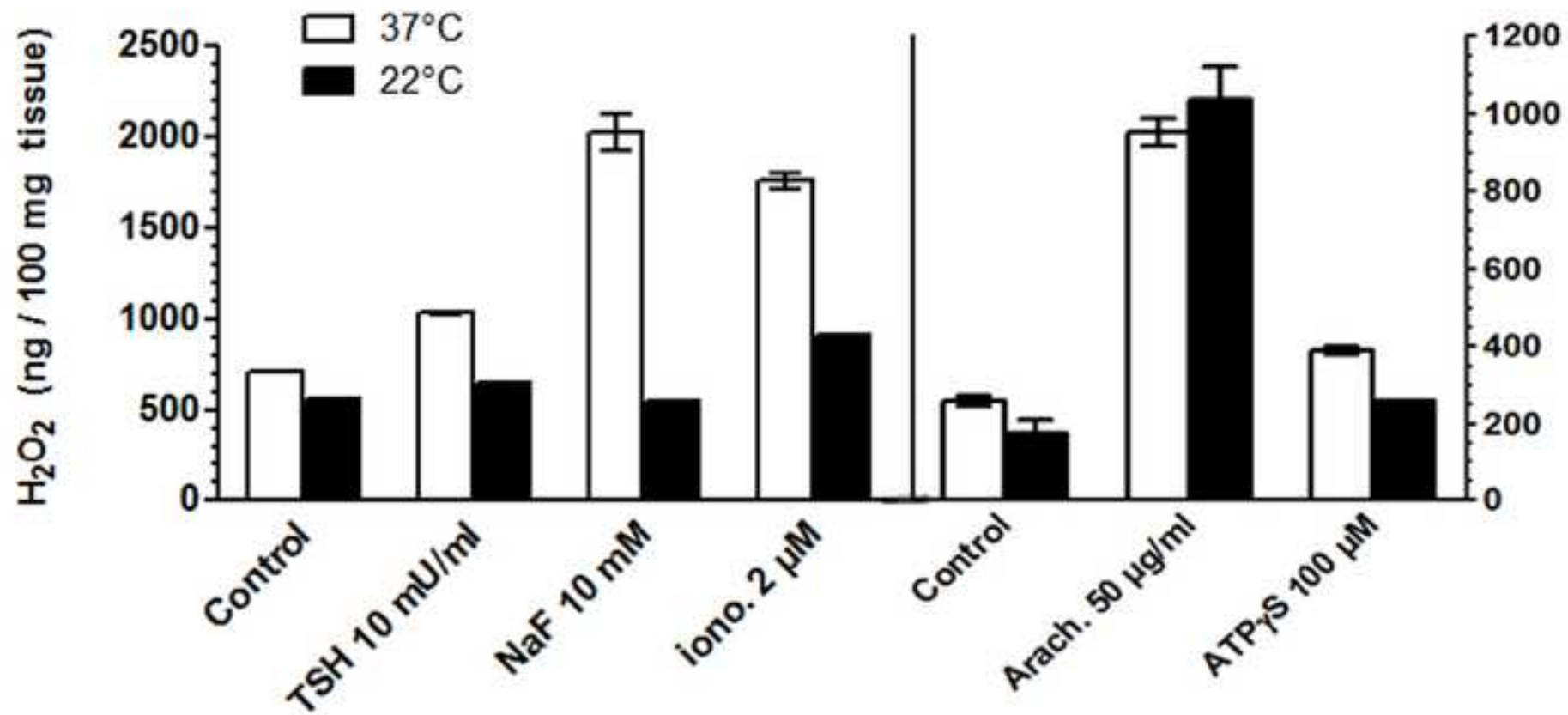

Figure 6

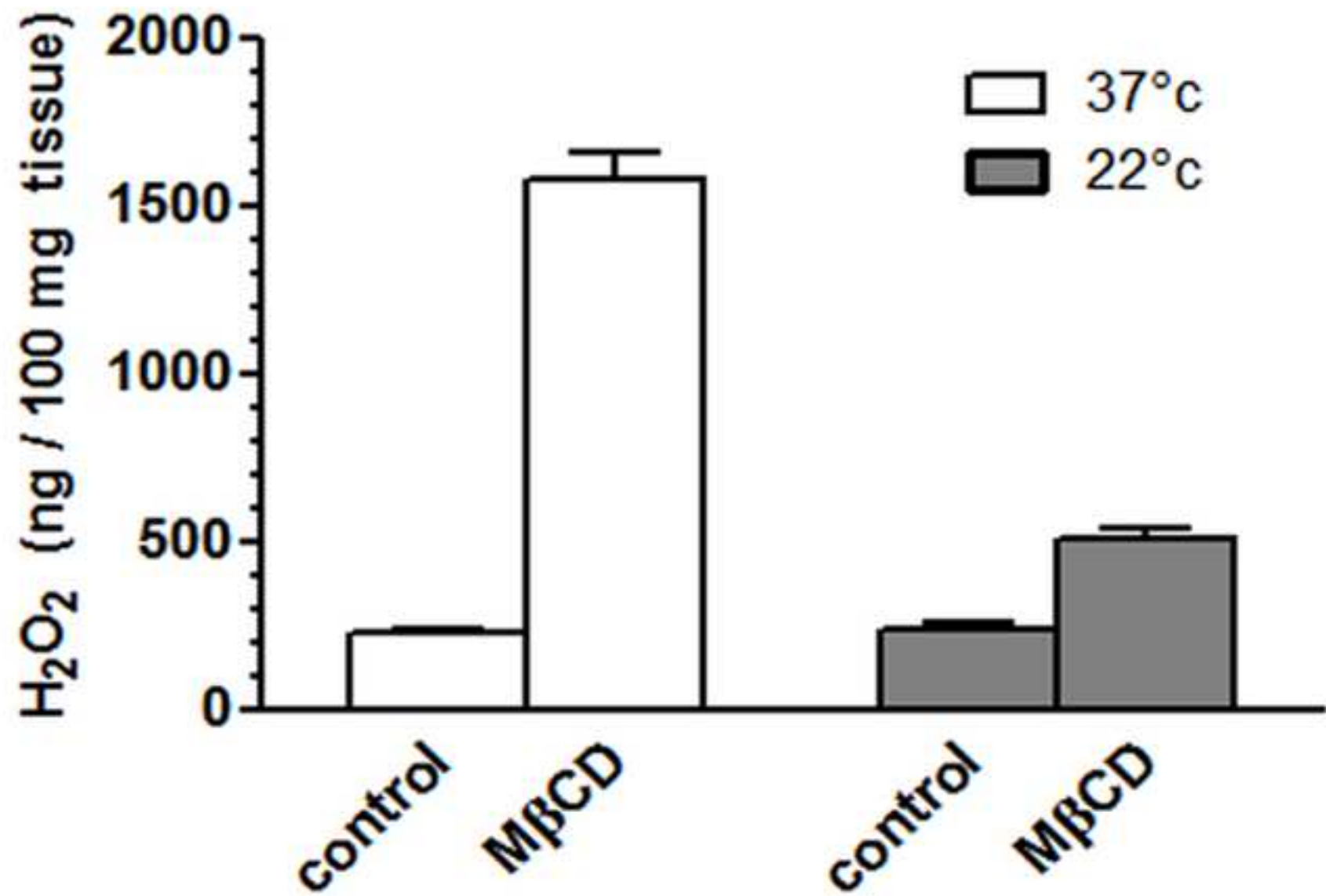

Figure 7

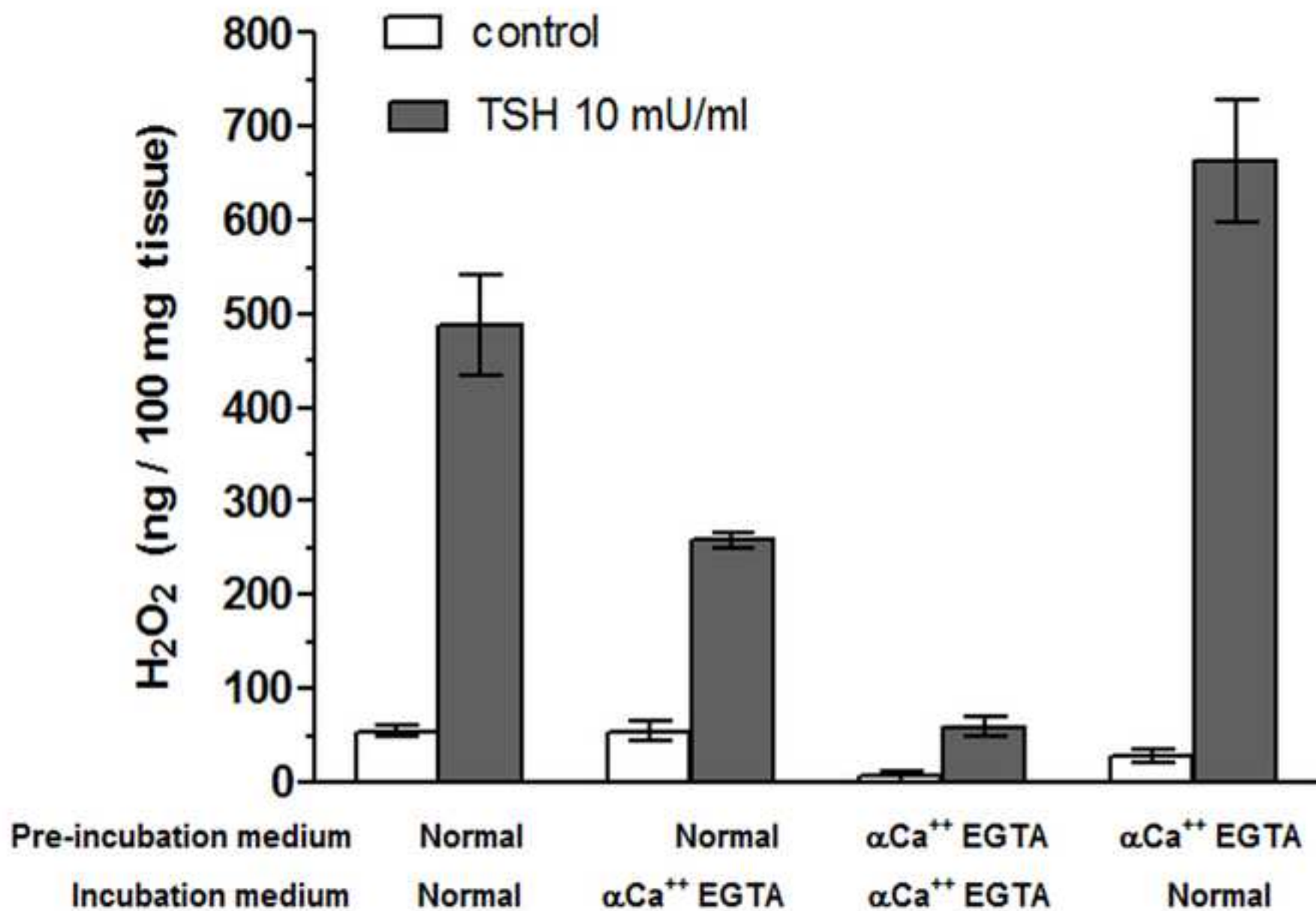

Figure 8

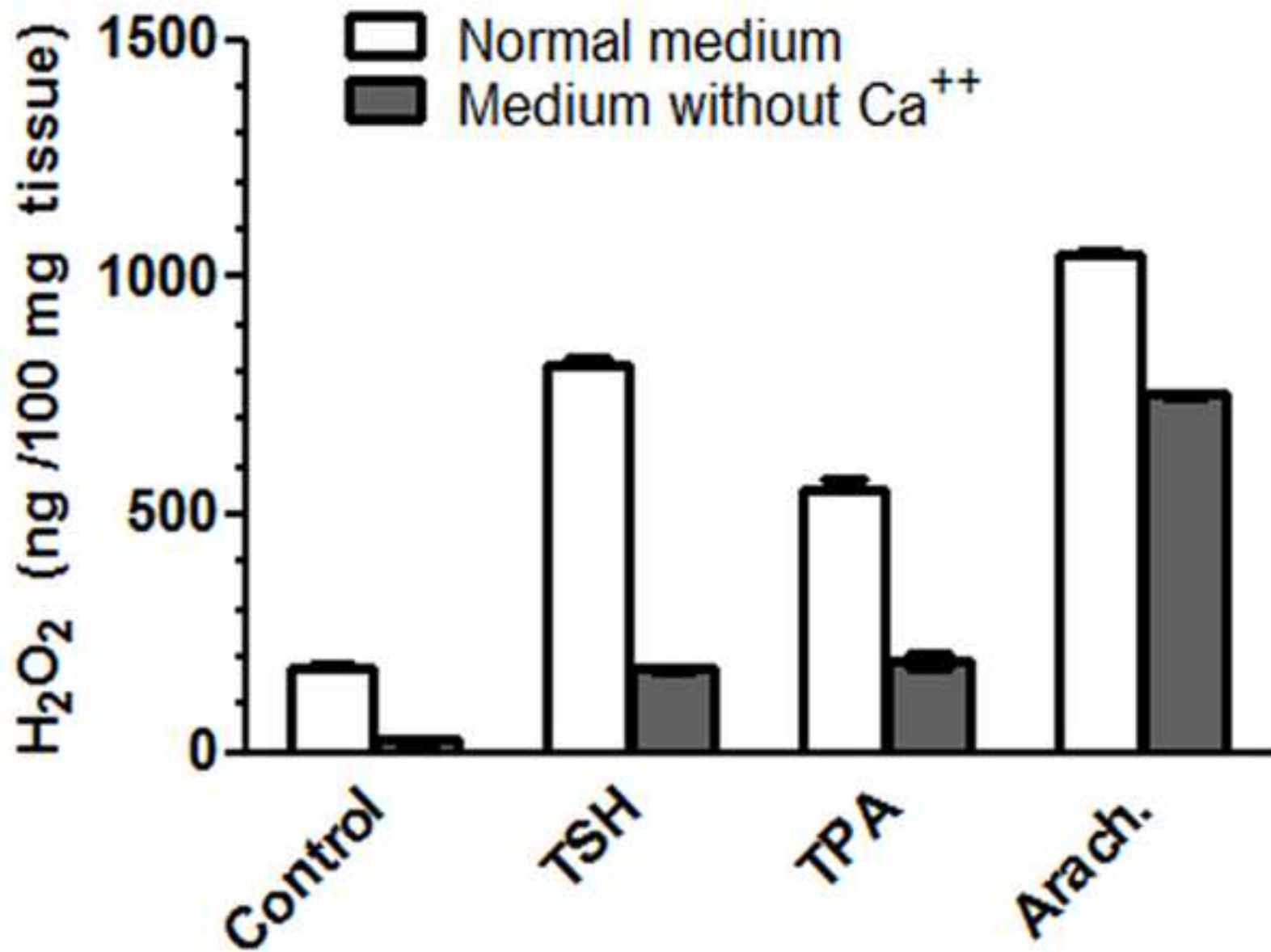

Figure 9

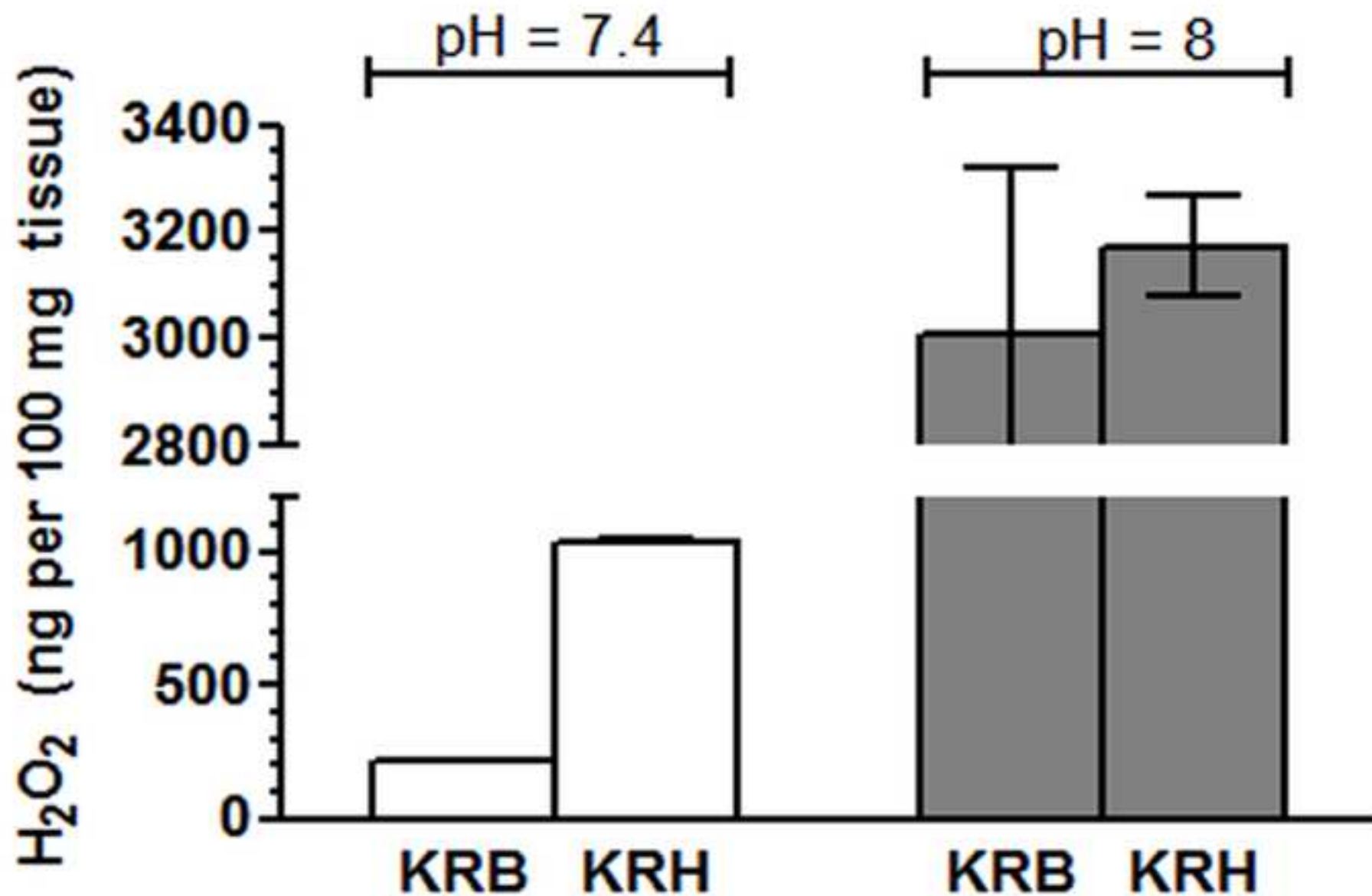

Figure 10

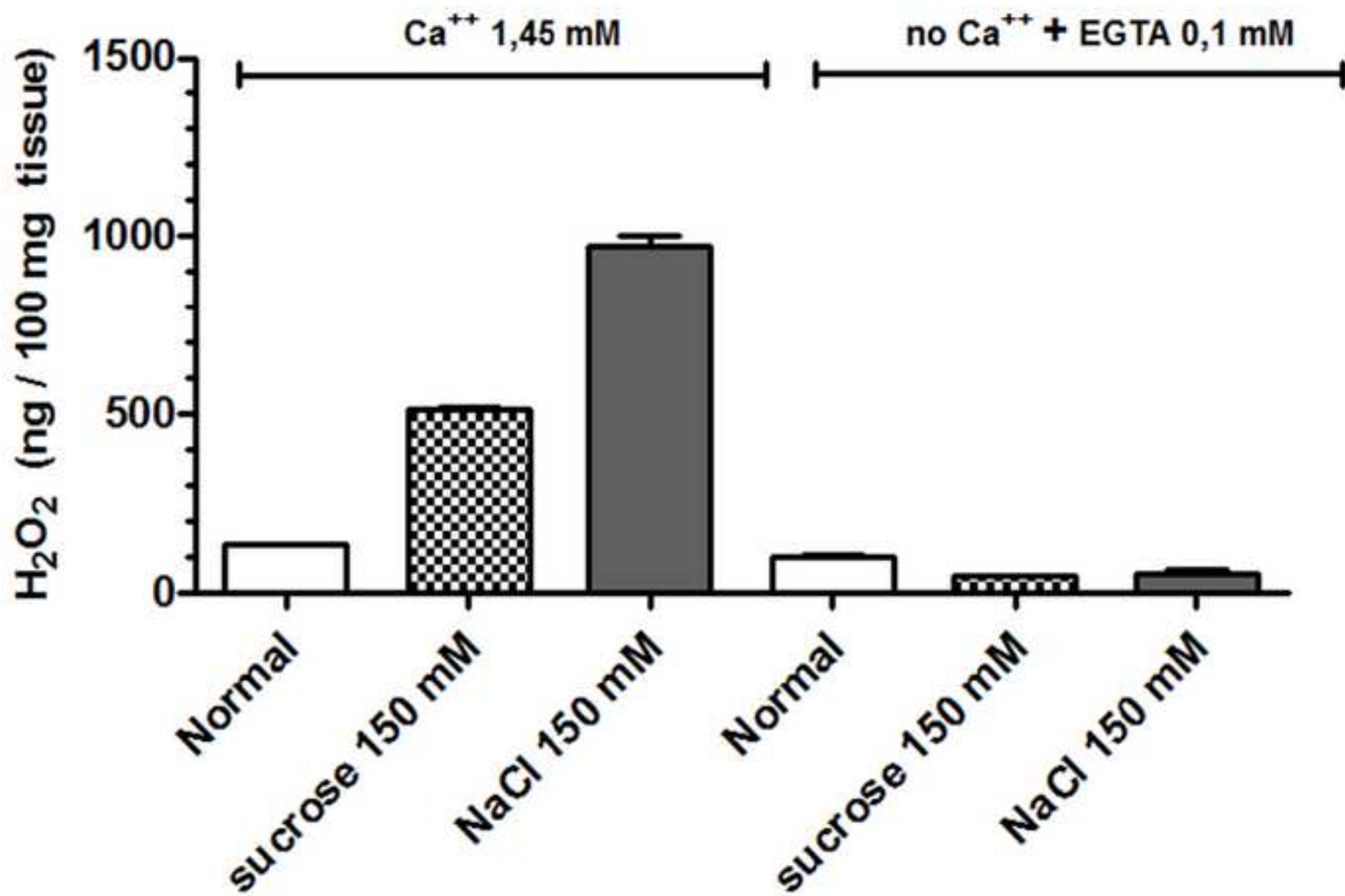
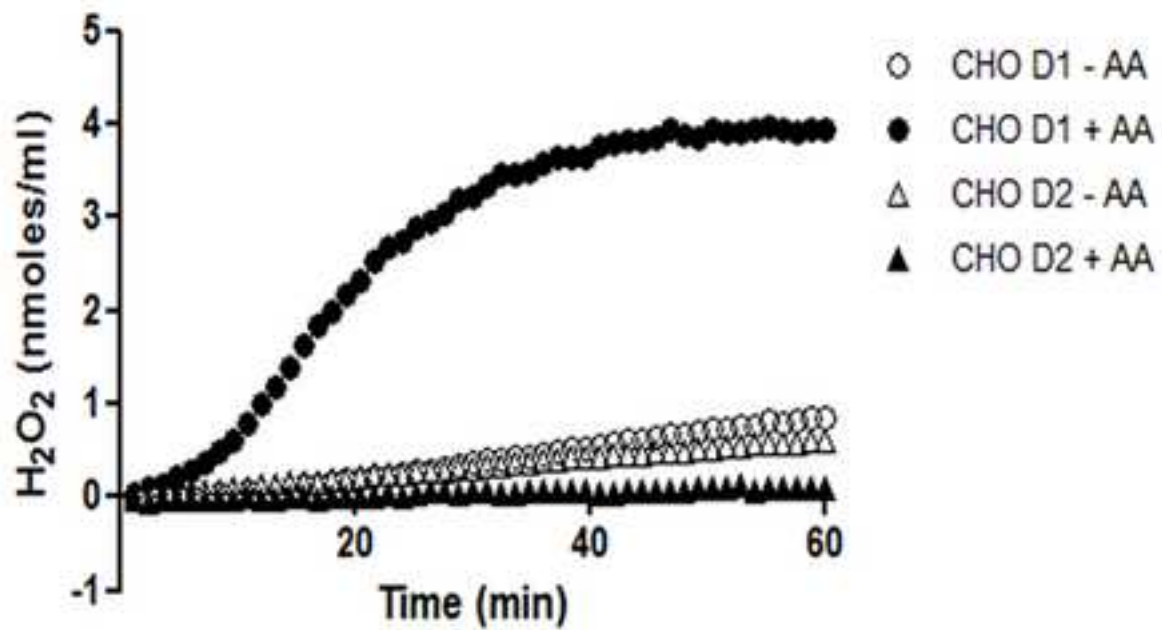

Figure 11

A.



B.

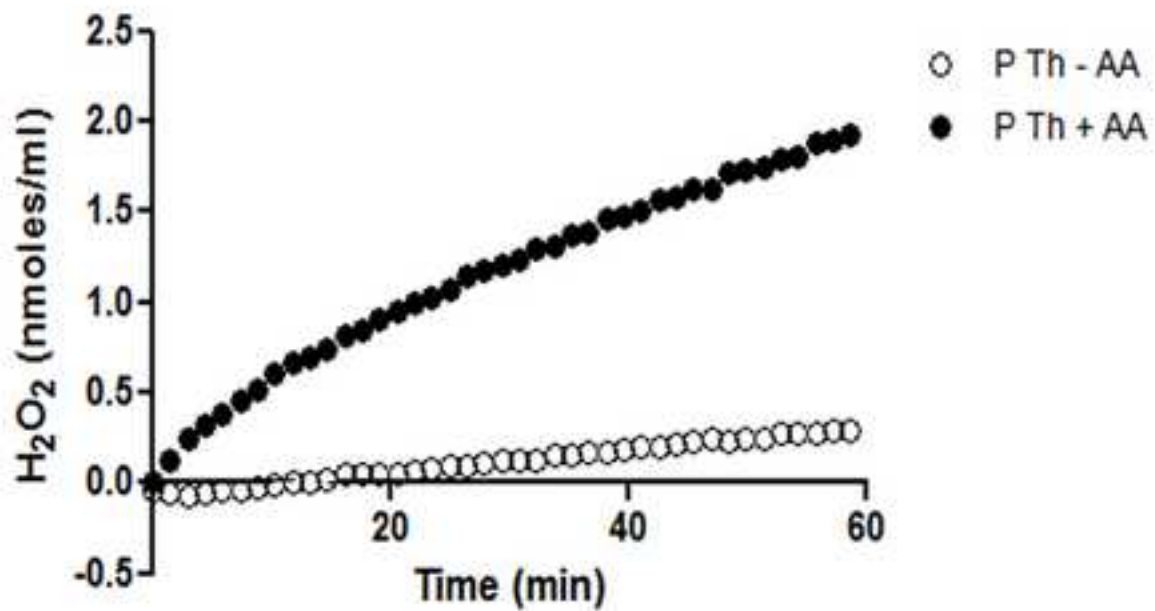

Figure 12

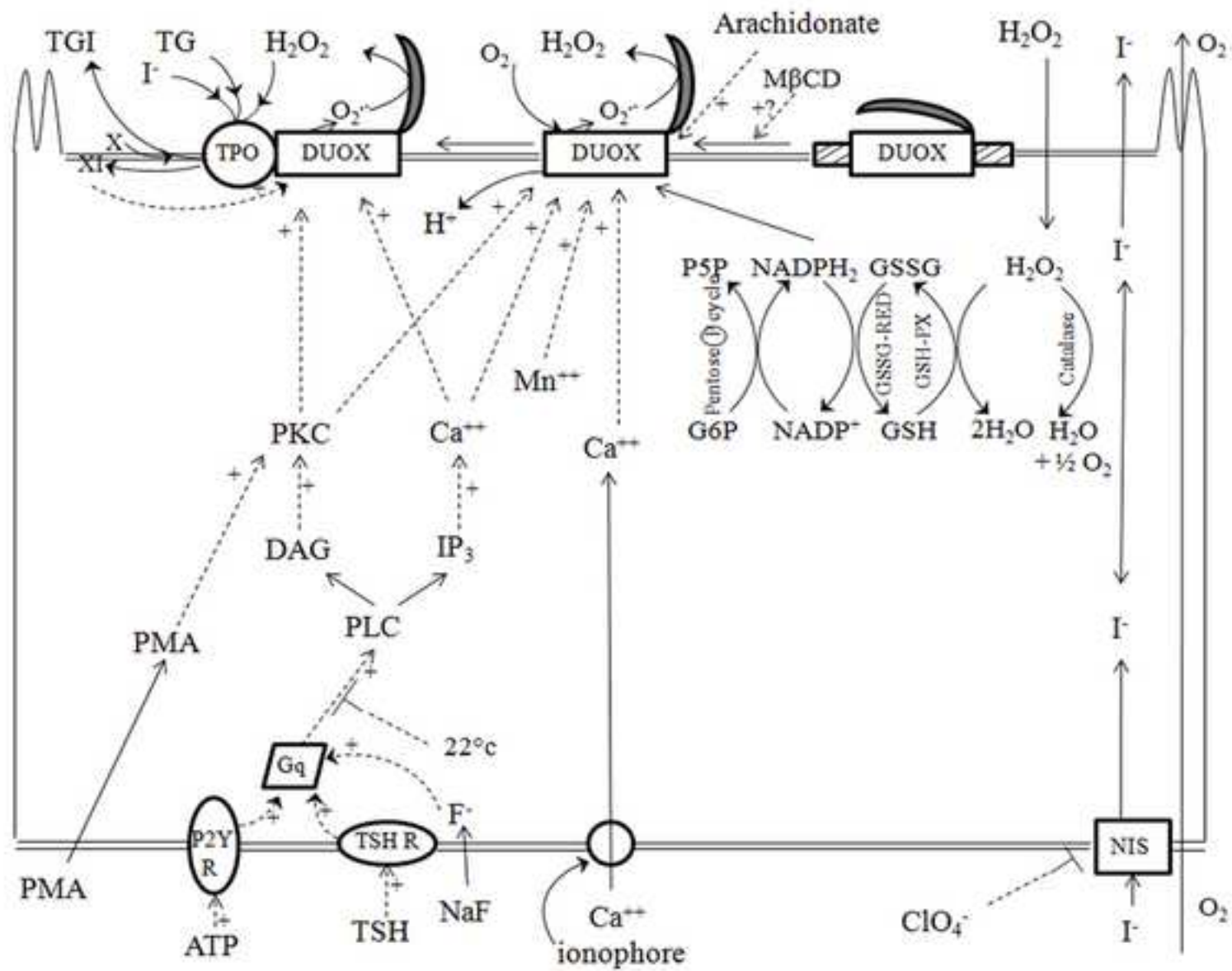

Figure 13

Table 1. Effect of catalase on measured H_2O_2 generation and iodide binding to proteins (PBI) in pig thyroid slices.

Catalase (U/ml)	Catalase activity test (no tissue) ¹	H_2O_2 measured during tissue incubation ²			PBI formed by tissue ³
		HRP (μ g/ml)			
		0	10	100	
0	818 \pm 20	24 \pm 5	293 \pm 21	635 \pm 30	44 \pm 7
100	0	0	268 \pm 15	585 \pm 11	43 \pm 3
10700	n.d.	0	39 \pm 2	233 \pm 7	n.d.

Table 2. Definition of the two compartments of pig thyroid slices.

	Slices thickness mm	H₂O₂ ng/100 mg tissue	H₂O₂ ng/mm² tissue	Iodide content cpm/mg tissue	PBI in %
Thin slices	0.26 ± 0.02	1021 ± 30	2.5 ± 0.05	5856 ± 70	9.1 ± 0.8
Thick slices	0.54 ± 0.06	470 ± 40	2.5 ± 0.2	4467 ± 170	9.7 ± 0.8

Table 3. *Effects on H₂O₂ observed in the various models.*

	Thyroid slices	PCCI3 cells	CHOD1 cells	CHOD2 cells	Particulate of CHO cells	Conclusion
Glucose requirement for H ₂ O ₂ disposal	±	n.d.	0	±	n.d.	Model specificity
NaN ₃ inhibition of H ₂ O ₂ disposal	++	±	+	+	n.d.	General property
Glucose requirement for H ₂ O ₂ generation	+	±	±	±	n.d.	Relative model specificity
Stimulation by MβCD	++	0	0	0	n.d.	Thyroid structure specificity
TSH	+	+	0	0	0	Model specificity
ATP _γ s	+	+	+	+	n.d.	Ic general property
TPA	+	+	+	+	n.d.	Ic general property
Ionomycin	+	+	+	+	n.d.	Ic general property
NaF	+	+	+	+	n.d.	Ic general property
Inhibition at 22°C of stimulation by extracellular signals	+	+	+	+	0	Ic general property
Stimulating effect of intracellular pH	+	+	+	+	0	Ic general property
Inhibitory effect of medium NaCl	+	+	+	+	n.d.	Ic general property
Stimulatory effect of hyperosmolarity	+	+	+	+	n.d.	Ic general property
Stimulatory effect of arachidonate	+	+	+	0	+	Direct effect on enzyme system
Requirements for Ca ⁺⁺	++	++	++	++	++	Enzyme property

Table 4. *Characteristics of the effects of stimulatory agents on cells.*

	Onset	Permanence after washing	Inhibition at 22°C	Site of action
TSH	Immediate	0	++	Memb. outside the cell
ATP_γs	Immediate	0	++	Memb. outside the cell
Ionomycin	Immediate	0	±	Memb.
NaF	Delayed	++	++	Inner memb.
TPA	Immediate	+	±	Inside the cell
Hyperosmolarity	Rapid	+	n.d.	Inside the cell

Table 5. *Characteristics of the four biological models used.*

	Slices	PCC13	CHO	Particulate
Tissue structure	+	n.d.	n.d.	n.d.
Thyroid cell differentiation	+	±	n.d.	n.d.
Signal transduction pathways	+	+	+	n.d.
Separate enzymatic complex	n.d.	n.d.	n.d.	+

1100

1101 **HIGHLIGHTS**

1102 - M β CD, depletor of cholesterol, activates DUOXes only in differentiated thyroid cells.

1103 - Reversible tools to activate (NaF) and inhibit (22°C) Gq PLC cascade in intact cells.

1104 - Arachidonate as a direct activator of DUOX1.

1105 - New models of thyroid cell biology of H₂O₂ generation.

1106

ACCEPTED MANUSCRIPT