



HAL
open science

Robust Control of a Pressure Swing Adsorption Process.

H. Peng, Françoise Couenne, Yann Le Gorrec

► **To cite this version:**

H. Peng, Françoise Couenne, Yann Le Gorrec. Robust Control of a Pressure Swing Adsorption Process.. 18th World Congress of the International federation of Automatic Control, IFAC'12., Aug 2011, Milan, Italy. pp.7310-7315. hal-00720345

HAL Id: hal-00720345

<https://hal.science/hal-00720345>

Submitted on 24 Jul 2012

HAL is a multi-disciplinary open access archive for the deposit and dissemination of scientific research documents, whether they are published or not. The documents may come from teaching and research institutions in France or abroad, or from public or private research centers.

L'archive ouverte pluridisciplinaire **HAL**, est destinée au dépôt et à la diffusion de documents scientifiques de niveau recherche, publiés ou non, émanant des établissements d'enseignement et de recherche français ou étrangers, des laboratoires publics ou privés.

Robust Control of a Pressure Swing Adsorption Process [★]

H. Peng ^{*} F. Couenne ^{*} Y. Le Gorrec ^{**}

^{*} *Université de Lyon, F-69622, Lyon, France;
Université Lyon 1, Villeurbanne, LAGEP, UMR 5007 CNRS, France.
(e-mail: author@lagep.univ-lyon1.fr).*

^{**} *FEMTO-ST/AS2M, National Engineering Institute in Mechanics
and Microtechnologies, 25 000 Besançon, France(e-mail:
yann.le.gorrec@ens2m.fr)*

Abstract:

This paper presents the H_∞ control of a pressure swing adsorption process. This separation process is characterized by periodic operations. The objective of the control is to assign the trajectory of the output system purity and to reject the perturbation on the inlet composition. The control design is synthesized from some Hammerstein model that approximates the cyclic process. The control scheme is designed using H_∞ optimization method. J -spectral factorization is applied to derive the controller. The controller is then validated both on the Hammerstein and complete models. Simulation results are given. Comparison with PI controller is provided.

Keywords: Pressure swing adsorption, Hammerstein model, H_∞ control, J -spectral factorization, Time-delay systems, Smith predictor

1. INTRODUCTION

Pressure Swing Adsorption (P.S.A) processes are used for separation operations. They are based on the adsorption phenomenon, that is to say, the property that have mixture. The P.S.A process consists of several fixed-bed adsorbers and is operated cyclically. Typically it is made up with two columns working in parallel, one being devoted to high pressure adsorption, the other to low pressure desorption. Each cycle of the basic P.S.A process contains four steps: pressurization, high-pressure adsorption, depressurization and low pressure desorption. The mathematical model of the P.S.A process is made of a set of partial differential equations (PDEs) associated with the packed reactor with periodic boundary conditions that link each step.

P.S.A process control has been studied in Kowler and Kadlec (1972); Matz and Knaebel (1987) and more recently in Grossmann et al. (2010); Bitzer (2004, 2005). In the latter, the authors proposed a model-based tracking control scheme. The cycle time was used as the control variable so it did not allow theoretical discrete time systems analysis.

In this paper, we use the Hammerstein model for control law synthesis. This model encompasses the cyclic nature of the P.S.A process. Moreover, the distributed behavior is taken into account as pure time-delay in the mean model. The objective of the control design is to track some optimal purity profile acting on the ratio characterizing the separation (adsorption time/desorption time) and to reject perturbations of inlet composition. This is the reason why

[★] This work was financially supported by French Research Agency (ANR) in the context of the the Young Researcher Program RE-CIPROC (ref code ANR-06-JCJC-0011)

static linearization and robust H_∞ control design have been applied.

The paper is organized as follows: in the section 2 and 3 are presented the complete P.S.A model and the simplified one respectively. The Hammerstein model-based control design is given in section 4. The feedforward control scheme is proposed by an inverse of nonlinear static gain of the Hammerstein model and the feedback control design is proposed by H_∞ optimization method in order to guarantee the tracking performance and the rejection of the disturbance in spite of time delay. Simulation results and discussion are given in the last section.

2. MATHEMATICAL MODEL OF P.S.A PROCESS

The main element of the process is the adsorption column. In order to develop a mathematical model of the P.S.A process, the following assumptions are introduced:

- (1) The pressure variations during the pressurization and depressurization steps are taken into account by considering that the pressure varies linearly with time (see Damien Leinekugel-Le-Cocq (2004) for details)
- (2) The process is operating at isothermal conditions.
- (3) Gas mixture is assumed to be ideal.
- (4) The pressure drop through the bed is negligible.
- (5) We assume axially dispersed plug flow model.
- (6) Linear driving force is used for mass transfer
- (7) The bed pressure is constant during the adsorption and desorption steps.
- (8) The adsorption equilibrium is linear ($q_i^* = K_i c_i$ where q_i and c_i are the concentrations in the pellet and in the fluid phase respectively).

Let us consider the flow of a gaseous mixture of n components in a fixed-bed filled with adsorbent particles. Subject to the above assumptions, the balances for the i^{th} component are as follow:

- (1) Component mass balance in fluid phase

$$\frac{\partial c_i}{\partial t} = D_{a_i} \frac{\partial^2 c_i}{\partial z^2} - \frac{\partial v c_i}{\partial z} - \frac{1 - \varepsilon}{\varepsilon} \frac{\partial q_i}{\partial t} \quad (1)$$

- (2) Component mass balance in solid phase

$$\frac{\partial q_i}{\partial t} = k_i (q_i^* - q_i) \quad (2)$$

where z is the spatial coordinate, c_i is the concentration in the gas phase, D_{a_i} is the axial dispersion coefficient, v is the velocity of gas flow, ε is the bed porosity, q_i is the concentration in the solid phase, q_i^* is the amount adsorbed at equilibrium, k_i is the effective mass transfer coefficient, and K_i is the adsorption equilibrium constant.

The Danckwerts' boundary conditions during the different steps are given as follows:

- (1) Pressurization

$$D_{a_i} \frac{\partial c_i}{\partial z} \Big|_{z=0} = -v_0 (c_i|_{z=0^-} - c_i|_{z=0}) \text{ and } \frac{\partial c_i}{\partial z} \Big|_{z=L} = 0 \quad (3)$$

- (2) Adsorption

$$D_{a_i} \frac{\partial c_i}{\partial z} \Big|_{z=0} = -v_H (c_i|_{z=0^-} - c_i|_{z=0}) \quad (4)$$

$$v|_{z=0} = v_H \text{ and } \frac{\partial c_i}{\partial z} \Big|_{z=L} = 0$$

- (3) depressurization

$$v|_{z=L} = 0, \quad \frac{\partial c_i}{\partial z} \Big|_{z=0} = 0 \text{ and } \frac{\partial c_i}{\partial z} \Big|_{z=L} = 0 \quad (5)$$

- (4) Desorption

$$D_{a_i} \frac{\partial c_i}{\partial z} \Big|_{z=L} = -v_L (c_i|_{z=L} - c_i|_{z=L^+}) \quad (v_L < 0)$$

$$v|_{z=L} = v_L \text{ and } \frac{\partial c_i}{\partial z} \Big|_{z=0} = 0 \quad (6)$$

where L is the length of adsorption column, v_0 is the inlet velocity and v_L , v_H signify respectively the flow velocity in the phase at low pressure and high pressure.

3. SIMPLIFICATION OF THE P.S.A MODEL

The cyclic nature of P.S.A process makes difficult the use of distributed parameter of the P.S.A model for the control design. So, we introduce the Hammerstein model to approximate the overall P.S.A model. For this purpose we assume that the gas velocity of the external gas source is constant, as well as the cycle time T_{cyc} . The advantage of this choice is that the linear part of Hammerstein model is time invariant.

The output variable is the purity of component P_r , defined in Bitzer (2004, 2005) as the ratio of the time averaged molar flow rate of the component over the total time averaged molar flow rate. The input variable is chosen as the ratio between the duration of adsorption and that of desorption: $\alpha := \frac{T_{ads}}{T_{des}}$. This choice of manipulated variable is quite new. The resulting Hammerstein model is depicted in Fig. 1. It should be noted that the purity of product P_r ,

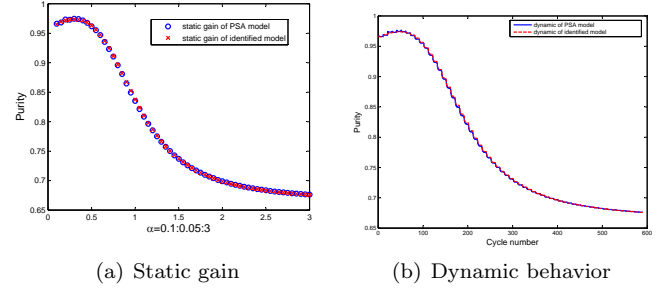

Fig. 2. Behavior of the P.S.A and Hammerstein models.

can only be obtained at the end of each cycle, so the linear dynamics includes the time delay T_{cyc} .

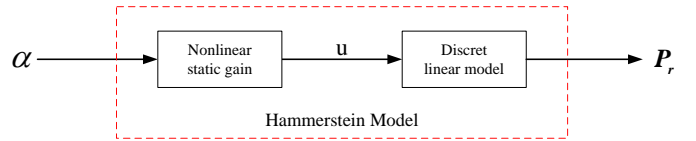

Fig. 1. Representation of the Hammerstein model

3.1 Model identification

The identification of the Hammerstein model consists of the identification of the nonlinear static gain (obtained by the curve fitting method) and the identification of the discrete linear model (obtained using the Matlab identification toolbox). With the choice of input and output variables as given above, the identified model is given by (7).

$$u = \sum_{i=0}^r c_i \alpha^i \quad (r = 11) \quad \text{nonlinear static gain} \quad (7)$$

$$H = \frac{P_r}{u} = \underbrace{\frac{0.3833z^{-1} + 0.3833z^{-2}}{1 - 0.1011z^{-1} - 0.1325z^{-2}}}_{G_r} q^{-1} \quad \text{discrete model} \quad (8)$$

where G_r is the rational part of the discrete linear model.

The coefficients of the polynomial approximation, stocked in a look up table (LUT) in order to be used for the feedforward control design, are given in Tab. 1.

c_0	0.005217867316353	c_6	27.919194533941987
c_1	-0.099623708560465	c_7	-21.333747560439217
c_2	0.829430245914190	c_8	9.487190132322487
c_3	-3.941066945370876	c_9	-2.530959095704418
c_4	11.732987224101695	c_{10}	0.407464813693482
c_5	-22.580552078146759	c_{11}	0.942236055943234

Table 1. Coefficients of the polynomial

Fig. 2(a) and Fig. 2(b) represent respectively the nonlinear static characteristics and the linear dynamic behavior of the identified models. The precision of the nonlinear static characteristic of the identified model guarantees the tracking performance.

3.2 Identification of the disturbance

We consider that the disturbance signal d comes from the change of concentration of one component to be adsorbed in the feed of gas mixture. The corresponding output is the variation of purity of this component at the output, noted by ΔP . The transfer function G_d between d and ΔP is obtained with the same identification method as above. We obtain :

$$G_d = \frac{0.296 + 0.296z^{-1}}{1 + 0.4308z^{-1} - 0.3534z^{-2}} \quad (9)$$

4. HAMMERSTEIN MODEL-BASED H_∞ TRACKING CONTROL

The objective of the control design is to assign the trajectory of the purity P_d and to reject the perturbation on the input composition acting on α as control variable. The control scheme proposed in this paper consists of feedforward tracking control and feedback control for regulation as shown in Fig. 3(a). The feedforward control uses the inverse of the nonlinear static gain, denoted NL^{-1} , in order to obtain the control value α . It should be noted that the inverse function of the nonlinear static gain may not formally exist and therefore the implementation using a look-up table (numerical inversion) is only an approximation. Due to the disturbance signal d and model uncertainty, the feedback controller K is necessary to adjust the real input α according to the error e . The block NL^{-1} is added after the feedback controller in order to wipe off the nonlinear effect, and the fine tuning value $\Delta\alpha$ around α is generated. The final control value is given by $\alpha_f = \alpha + \Delta\alpha$.

By replacing the P.S.A model(PDEs) with the Hammerstein model in the control scheme given in Fig. 3(a), we easily obtain the simplified control scheme given in Fig. 3(b).

4.1 H_∞ feedback controller design with time delay

The next task is to design H_∞ feedback controller. From Fig. 3(b), the control design scheme is derived through the weighting functions W_e and W_u as shown in Fig. 3(c).

The presence of the time delay in the Hammerstein model increases the difficulty to treat the H_∞ control problem. In this paper, we adopt the method proposed in Zhong (2006). The principle is to isolate the time delay from the control loop and then to obtain a new linear system without time delay usable for the H_∞ controller design. This conversion of the objective problem simplifies greatly the handling of the control problem.

Firstly, the control design scheme (Fig. 3(c)) can be transferred to the standard representation of robust control, with P the generalized plant, w the exogenous input, z the controlled output, y the measured output and u the output of controller, shown in (Fig. 4) with

$$\begin{pmatrix} \tilde{e} \\ \tilde{u} \\ e \end{pmatrix} = \underbrace{\begin{pmatrix} W_e & -W_e G_d & -W_e G_r \\ 0 & 0 & e^{\tau s} W_u \\ 1 & -G_d & -G_r \end{pmatrix}}_P \begin{pmatrix} P_d \\ d \\ u' \end{pmatrix} \quad (10)$$

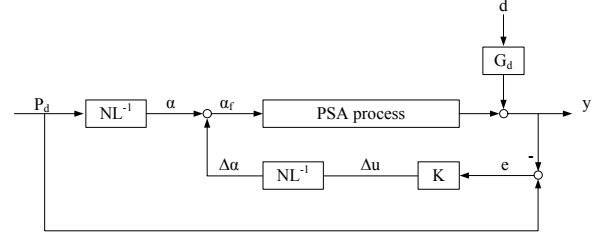

(a) Closed loop control scheme

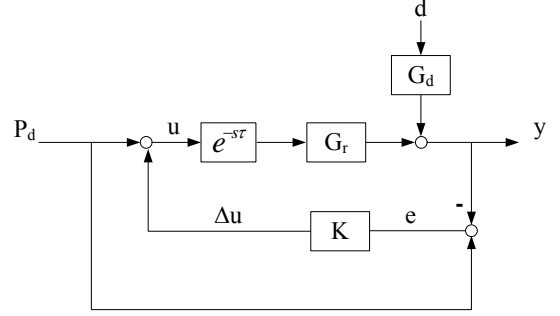

(b) Simplified scheme

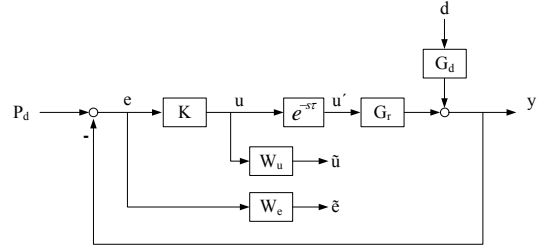

(c) H_∞ control design scheme

Fig. 3. Closed loop control schemes

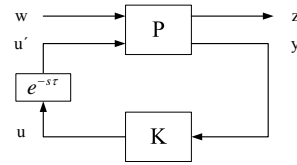

Fig. 4. Standard representation of H_∞ control scheme

According to the linear fractional transformation(LFT), the closed-loop transfer function between w and z is given by (11):

$$T_{zw} = P_{11} + e^{-\tau s} P_{12} K (I - e^{-\tau s} P_{22} K)^{-1} P_{21} \quad (11)$$

T_{zw} can be represented graphically by (Fig. 5)

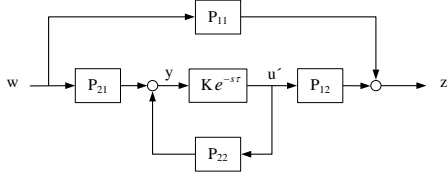

Fig. 5. Graphical representation of T_{zw}

From the existence of P_{11} , there exists an instantaneous response from w to z . During $[0, \tau]$, this response is not controllable. To deal with this problem, the idea is to isolate the uncontrollable element from P_{11} .

Let us define

$$Z_1(s) = P_{11} - \tilde{P}_{11}(s)e^{-\tau s} \quad (12)$$

where $\tilde{P}_{11}(s)$ is a rational transfer function.

The transfer function T_{zw} can be written

$$T_{zw}(s) = Z_1(s) + T_{z'w}(s) \quad (13)$$

with $T_{z'w} = e^{-\tau s} \{ \tilde{P}_{11} + P_{12}K(I - e^{-\tau s}P_{22}K)^{-1}P_{21} \}$

The transfer function $T_{z'w}$ is represented in Fig. 6.

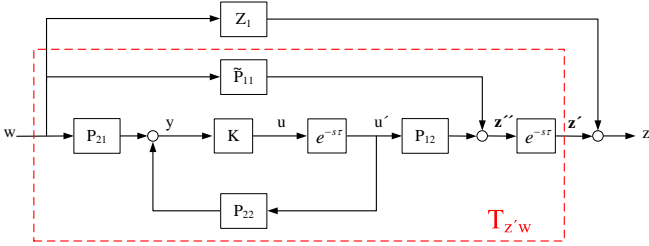

Fig. 6. Graphical representation of $T_{z'w}$

According to the following inequality, see Mirkin (2000)

$$\|Z_1(s)\|_\infty < \|T_{zw}(s)\|_\infty \leq \|Z_1(s)\|_\infty + \|T_{z'w}(s)\|_\infty \quad (14)$$

we obtain a new H_∞ optimization problem as follows:

$$\|T_{z'w}(s)\|_\infty < \gamma' \quad (15)$$

Naturally, we consider the controller K as the Smith predictor format, e.g:

$$K(s) = K_0(s)(I - Z_2(s)K_0(s))^{-1} \quad (16)$$

$$Z_2(s) = \tilde{P}_{22} - e^{-\tau s}P_{22} \quad (17)$$

Then, we obtain the following relations (Fig. 7)

$$T_{z'w}(s) = e^{-\tau s}T_{z''w}(s) \quad (18)$$

$$T_{z''w} = \tilde{P}_{11} + P_{12}K(I - e^{-\tau s}P_{22}K)^{-1}P_{21} \quad (19)$$

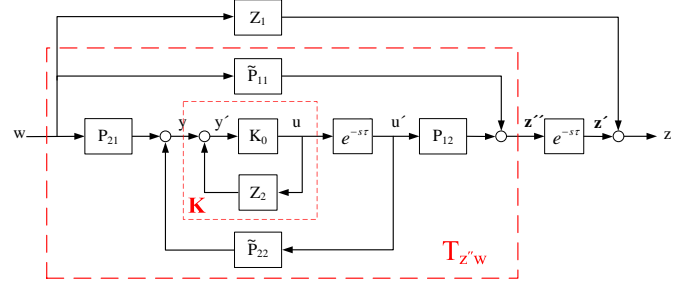

Fig. 7. Graphical representation of $T_{z''w}$

By replacing the K in eq. (19) with eq. (16), we obtain

$$T_{z''w} = \tilde{P}_{11} + P_{12}K_0(I - \tilde{P}_{22}K_0)^{-1}P_{21} \quad (20)$$

with

$$\begin{pmatrix} z'' \\ y' \end{pmatrix} = \tilde{P}(s) \begin{pmatrix} w \\ u \end{pmatrix} \quad (21)$$

where $u = K_0 y'$, $z' = e^{-\tau s} z''$, and

$$\tilde{P}(s) = \begin{pmatrix} \tilde{P}_{11}(s) & P_{12}(s) \\ P_{21}(s) & \tilde{P}_{22}(s) \end{pmatrix} \quad (22)$$

Till now, we obtain a new system, with a rational transfer matrix $\tilde{P}(s)$ without time delay. The original H_∞ control problem $\|T_{zw}(s)\|_\infty < \gamma$ is modified into $\|T_{z''w}(s)\|_\infty < \gamma'$.

We can note that the two functions (Z_1, Z_2) play an important role during this manipulation. The choice of these functions depends on the stability of P_{11} and P_{22} . If they are stable, one can choose:

$$Z_1(s) = P_{11}(s) - P_{11}(s)e^{-\tau s} \quad (23)$$

$$Z_2(s) = P_{22}(s) - P_{22}(s)e^{-\tau s} \quad (24)$$

Otherwise, one has to choose:

$$Z_1(s) = \begin{pmatrix} A_{11} & B_{11} \\ C_{11} & D_{11} \end{pmatrix} - e^{-\tau s} \begin{pmatrix} A_{11} & e^{A_{11}\tau} B_{11} \\ C_{11} & 0 \end{pmatrix} \quad (25)$$

$$Z_2(s) = \begin{pmatrix} A_{22} & B_{22} \\ C_{22} & D_{22} \end{pmatrix} - e^{-\tau s} \begin{pmatrix} A_{22} & B_{22} \\ C_{22} & D_{22} \end{pmatrix} \quad (26)$$

where $\begin{pmatrix} * & * \\ * & * \end{pmatrix}$ represents the state realization of the system.

4.2 Choice of weighting functions

The usual choice of the weighting functions W_e and W_u is presented in Zhou and Doyle (1997). W_e is selected to be a low-pass filter to reflect the desired performance characteristics :

$$W_e = \frac{s/M_s + \omega_b}{s + \omega_b e_\varepsilon} \quad (27)$$

where M_s is the peak gain of the sensitivity function, ω_b is the bandwidth frequency and e_ε is the steady-state error. In our case, we choose $e_\varepsilon = 0.001$, $M_s = 1.5$ et $\omega_b = 0.15$.

The control weighting function W_u is chosen to be a high-pass filter to penalize the control signal. In our case, we choose:

$$W_u = \frac{s + \omega_{bu}/M_u}{\varepsilon_u s + \omega_{bu}} \quad (28)$$

where M_u is the peak gain of the control sensitivity function, ω_{bu} is the controller bandwidth and ε_u is a small and positive number. In our case, we choose $\varepsilon_u = 0.001$, $M_u = 1.5$ et $\omega_{bu} = 0.5$.

4.3 H_∞ control problem via J -spectral factorization

We have demonstrated that the new H_∞ problem : $\|T_{z''w}(s)\|_\infty < \gamma'$ needs to be solved. The solution of this problem leads to the central controller K_0 . In this paper, the J -spectral factorization is applied for resolution of the H_∞ control problem. Although there are several methods regarding the solution of the H_∞ control problem via the J -spectral factorization, the method proposed by Meinsma and Zwart (2000) will be used where only one J -spectral factorization is needed with the help of the chain scattering representation, see Kimura (1997). Precisely, the new H_∞ control problem will be described firstly using chain scattering representation, as shown in (Fig. 8).

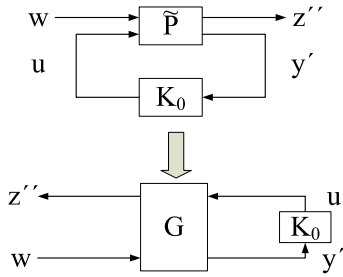

Fig. 8. Chain scattering representation of the H_∞ control problem

$$\begin{pmatrix} z'' \\ y' \end{pmatrix} = P \begin{pmatrix} w \\ u \end{pmatrix} \Leftrightarrow \begin{pmatrix} z'' \\ w \end{pmatrix} = G \begin{pmatrix} u \\ y' \end{pmatrix} \quad (29)$$

and the transfer function $T_{z''w}$ becomes

$$T_{z''w} = (G_{11}K_0 + G_{12})(G_{21}K_0 + G_{22})^{-1} \quad (30)$$

For the purpose of handling of the new system described by the chain scattering representation, we introduce two important theorems due to Meinsma and Zwart (2000):

Theorem 1. Suppose that a matrix $M \in H_\infty^{(n_z+n_w) \times (n_u+n_y)}$ satisfies $M \sim J(\gamma)M = \hat{J}$ almost everywhere on the imaginary axis with $J(\gamma) := \begin{pmatrix} I_{n_z} & 0 \\ 0 & -\gamma^2 I_{n_w} \end{pmatrix}$, $\hat{J} := \begin{pmatrix} I_{n_u} & 0 \\ 0 & -I_{n_y} \end{pmatrix}$ and $M \sim(s) = [M(-\bar{s})]^*$, * standing for conjugate transpose. Consider the following equation:

$$\begin{pmatrix} H_1 \\ H_2 \end{pmatrix} = M \begin{pmatrix} U_1 \\ U_2 \end{pmatrix} \quad (31)$$

with $H_1 \in H_\infty^{n_z \times n_y}$, $H_2 \in H_\infty^{n_w \times n_y}$, $U_1 \in H_\infty^{n_u \times n_y}$, $U_2 \in H_\infty^{n_y \times n_y}$ and $M = \begin{pmatrix} M_{11} & M_{12} \\ M_{21} & M_{22} \end{pmatrix}$. Then, the two following conditions are equivalent:

- (1) H_2 is bistable and $\|H_1 H_2^{-1}\|_{H_\infty} < \gamma$;
- (2) M_{22} and U_2 are bistable and $\|U_1 U_2^{-1}\|_{H_\infty} < 1$.

where H_∞ denotes the standard Hardy spaces defined on the open right-half plane and the elements of H_∞ are called stable. H_2 being bistable means $H_2, H_2^{-1} \in H_\infty$. I represents identity matrix and p, q, m, n are dimensions of corresponding matrices. γ is some positive number.

Theorem 2. Suppose that the matrix $G \in H_\infty^{(n_z+n_w) \times (n_u+n_y)}$ is proper and the columns are independent on the imaginary axis including infinity. For $\gamma > 0$ given, there exists a stabilizing controller $K \in F_\infty^{-1}$ such that $\|T_{zw}\|_{H_\infty} < \gamma$ if and only if the following conditions are satisfied:

- (1) The signature matrix

$$J_{n_z, n_w}(\gamma) = \begin{pmatrix} I_{n_z} & 0 \\ 0 & -\gamma^2 I_{n_w} \end{pmatrix}, \quad J_{n_u, n_y} = \begin{pmatrix} I_{n_u} & 0 \\ 0 & -I_{n_y} \end{pmatrix} \quad (32)$$

$G \sim J_{n_z, n_w}(\gamma)G$ and J_{n_u, n_y} have the same number of positive and negative eigenvalues on the imaginary axis.

- (2) There exists a bistable matrix W such that

$$G \sim J_{n_z, n_w}(\gamma)G = W \sim J_{n_u, n_y} W$$

and the low right block Q_{22} of the matrix $Q := GW^{-1}$ is bistable.

All stabilizing controller K which satisfies $\|T_{zw}\|_{H_\infty} < \gamma$ are parameterized by

$$K = K_1 K_2^{-1} \quad \text{with} \quad (33)$$

$$\begin{pmatrix} K_1 \\ K_2 \end{pmatrix} = W^{-1} \begin{pmatrix} U \\ I \end{pmatrix} \quad U \in H_\infty^{n_u \times n_y}, \quad \|U\|_{H_\infty} < 1 \quad (34)$$

where n_w, n_z, n_u, n_y are the dimensions of w, z, u, y respectively.

The choice of U is not unique. Generally, we choose $U = 0$ and obtain the so-called central controller.

Theorem 1 transforms the H_∞ problem $\|T_{z''w}(s)\|_\infty < \gamma'$ in $\|U_1 U_2^{-1}\|_{H_\infty} < 1$. Theorem 2 gives the controller parametrization for the last problem.

4.4 Validation of the controller

Since the identified models are discrete ones, we use firstly the bilinear transformation to get the continuous models. With respect to the obtention of J -spectral factor W in Theorem 2 and the construction of the stabilizing controller K according to (33) and (34), we modified the routine proposed by Meinsma and Zwart (2000) to satisfy our requirements.

Since P_{11} and P_{22} are stable, we take Z_1, Z_2 as defined in (23).

¹ Meinsma and Zwart (2000). $F_\infty^{n \times m} := \{H^{-1}G : G \in H_\infty^{n \times m}, H \in H_\infty^{n \times n}, \det H \neq 0\}$

In our case, the supremum of the norm is $\gamma' \approx 1.5$ and the main controller K_0 is derived from equation (35)

$$K_0 = \frac{78.3s^3 + 279.9s^2 + 157.6s + 8.47}{s^4 + 373.5s^3 + 558s^2 + 0.0561s + 2.995 \times 10^{-8}} \quad (35)$$

According to eq. (16), we obtain the controller K :

$$K = \frac{78.3(s + 2.892)(s + 0.6231)(s + 0.06004)}{(s + 1.5)(s + 0.0001)(s + 5.367 \times 10^{-7})} \quad (36)$$

Next we suppose that a gas mixture (N_2, O_2) has to be separated. The desired purity profile of O_2 varies from 70% to 86% in 50 cycles. The desired purity curve is generated by the aforementioned polynomial method. The open loop simulation of the P.S.A model in presence of the disturbance introduced at 20th cycle is shown in Fig. 9. Simulations are performed from the PDEs model.

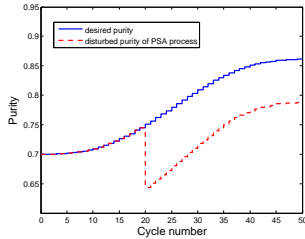

Fig. 9. Open loop simulation

The control objective is to assign the trajectory of the P.S.A output despite the disturbance. Fig. 10(a), Fig. 10(b) represent the Hammerstein based closed loop simulations with H_∞ control and PI control (designed through traditional method and heuristic adjustments), respectively. The control scheme is shown in Fig. 3(c). These results demonstrate that the tracking performances and convergence rapidity of H_∞ control with Hammerstein model are better than those with PI control.

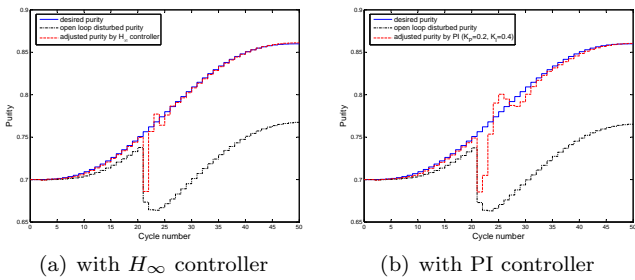

Fig. 10. Closed loop simulation with Hammerstein model.

The H_∞ controller works well with the Hammerstein model. So, this controller is applied to the P.S.A model (PDEs model) with the control scheme given by Fig. 3(a). Fig. 11(a) shows that the closed loop purity profile regulated by the H_∞ controller converges rapidly (about 5 cycles) towards the desired profile. On the contrary, the P.S.A process regulated by the PI controller shows that the tracking of the desired purity needs about 11 cycles, as shown in Fig. 11(b).

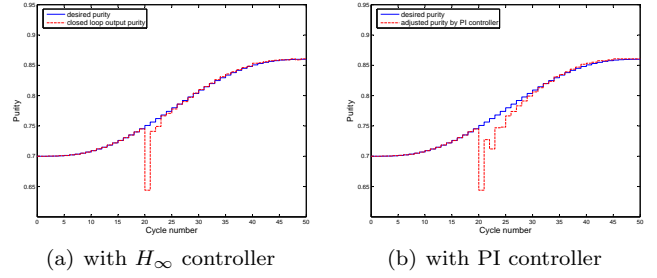

Fig. 11. Closed loop simulation with P.S.A model.

5. CONCLUSION

In this paper, the H_∞ tracking control law synthesis for a P.S.A process described by means of a Hammerstein model was investigated. The identification of Hammerstein model is carried out by way of simulation of P.S.A model. The feedforward controller is obtained by inverting the non-linear static gain and the feedback controller is designed using H_∞ optimization method. The results of simulation show that the control method is feasible and leads to better performances than the ones using traditional PI control. It should be noted that our results lacked the experimental validation and that we did not take into account the model uncertainty for the sake of P.S.A process property. In general, further research is required in order to validate the simulation results and improve the current control design.

REFERENCES

- M. Bitzer. Control of Periodically Operated Adsorption Processes. *Stuttgart university Phd thesis*, 2004.
- M. Bitzer. Model-based Nonlinear Tracking Control of Pressure Swing Adsorption Plants. *Lecture Notes in Control and Information Sciences, Springer*, 22:403-418, 2005.
- C. Grossmann, G. Ströhlein, M. Morari and M. Morbidelli. Optimizing model predictive control of the chromatographic multi-column solvent gradient purification (MC-SGP) process. *J. of Proc. Cont.*,20(5):618-629, 2010.
- D. Leinekugel-Le-Cocq. Contribution to the simplified dynamic modeling of a Pressure Swing Adsorption process (P.S.A). *Phd thesis of University Lyon 1*, 2004.
- G. Meinsma and H. Zwart. On H_∞ control for dead-time systems. *IEEE Trans. Aut. Control*, 45: 272-285, 2000.
- H. Kimura. Chain-scattering Approach to H_∞ Control. *Birkhuser Boston*, 1997.
- D.E. Kowler and R.H. Kadlec. The optimal control of a periodic adsorber *AIChE*, 18:1207-1219, 1972.
- M.J. Matz and K.S. Knaebel. Temperature front sensing for feed step control in pressure swing adsorption. *Ind. Eng. Chem. Res.*, 26:1638-1645, 1987.
- L. Mirkin. On the extraction of dead-time controllers from delay-free parametrizations. *In Pro. of 2nd IFAC Workshop on Linear Time Delay Systems*,p.157-162, 2000.
- D.M. Ruthven, S. Farooq and K.S. Knaebel. Pressure Swing Adsorption. *WILEY-VCH*, 1994.
- Q.C. Zhong. Robust Control of Time-delay Systems. *Springer*, 2006.
- K. Zhou and J.C. Doyle. Essentials of Robust Control. *Prentice Hall*, 1997.