



**HAL**  
open science

## Modeling and power regulation of horizontal variable speed wind turbines

Andreea Pinteaa, Haoping Wang, Nicolai Christov, Pierre Borne, Dumitru Popescu

► **To cite this version:**

Andreea Pinteaa, Haoping Wang, Nicolai Christov, Pierre Borne, Dumitru Popescu. Modeling and power regulation of horizontal variable speed wind turbines. *Studies in Informatics and Control*, 2011, 20 (3), pp.93. hal-00719475

**HAL Id: hal-00719475**

**<https://hal.science/hal-00719475>**

Submitted on 19 Jul 2012

**HAL** is a multi-disciplinary open access archive for the deposit and dissemination of scientific research documents, whether they are published or not. The documents may come from teaching and research institutions in France or abroad, or from public or private research centers.

L'archive ouverte pluridisciplinaire **HAL**, est destinée au dépôt et à la diffusion de documents scientifiques de niveau recherche, publiés ou non, émanant des établissements d'enseignement et de recherche français ou étrangers, des laboratoires publics ou privés.

# Modelling and power regulation of horizontal variable speed wind turbines

Andreea Pinte<sup>1</sup>, Haoping Wang<sup>2</sup>, Nicolai Christov<sup>3</sup>, Pierre Borne<sup>4</sup>, Dumitru Popescu<sup>1</sup>

<sup>1</sup> University "Politehnica" Bucharest, Splaiul Independentei 313, Bucharest, 60042, Romania, andreea.pinte@gmail.com, popescu\_upb@yahoo.com

<sup>2</sup> Nanjing University of Science and Technology, Automation School, Nanjing, China, haoping.wang@ieee.org

<sup>3</sup> Lille University of Science and Technology, Villeneuve d'Ascq, 59651, France, nicolai.christov@univ-lille1.fr

<sup>4</sup> Ecole Centrale de Lille, 59650, Villeneuve d'Ascq Cedex, France, pierre.borne@ec-lille.fr

**Abstract:** This paper deals with the development of a nonlinear model of a horizontal variable speed wind turbine, the obtaining of an appropriate linear model and the design and analysis of a linear quadratic controller with disturbance estimation. The optimisation criteria will have to define an acceptable compromise between the limitations of the power level in the above rated wind speeds and the maintenance of the aerodynamic properties of the rotor at high solicitations exerted by the wind. The main control objective is to provide an amount of energy that will not exceed the nominal parameters of the generator and thus avoid overheating.

**Keywords:** wind turbines, nonlinear systems, linear quadratic control.

## 1. Introduction

The last decades are characterized by an increase of the interest in the renewable energy sources and consequently in the need of finding control methods for optimizing the energy conversion. Among the renewable energy sources, the wind has become an attractive source of energy, determining in the same time the fastest growth of wind energy technology. Wind turbines are complex systems that function in a dynamic environment, where they risk being struck by lightning, or having ice deposited on the blades, stress, and even fire. But maybe the most important aspect is the variability of the wind. Different attempts to model this variation can be found in [1-3]. For our study though, we will consider the wind as constant in time and any change will be treated as a disturbance.

The studies done so far used either simplified either complex models of the wind turbine. But in most cases, the results concern only linear models [4-5], which are only approximations of the nonlinear models around a chosen functioning point [8]. This paper presents several preliminary results of a study aiming to provide a control solution for electric power limitation at high wind speeds

where solicitations are extremely important and can provoke damages of the turbine's structure. Because one needs prolonging the lifetime of the wind turbines components it becomes imperative in the control design to take into account the tower bending dynamics and the blade flexion modes. A disturbance observer based controller is proposed for estimating the external disturbances and then compensating them by using appropriate feedback. The controller performances are analyzed by numerical simulation for linear and nonlinear wind turbine models.

As it is well known there are many types of wind turbines configurations. From this variety, the ones operating at variable speed are currently the most used because of their numerous advantages. First of all, they are more flexible in terms of control and optimal operation [1], [9]. Secondly, the variable speed operation allows continuously adaptation of the rotational speed of the turbine in order to make the turbine operate constantly at its highest level of aerodynamic efficiency.

The performance of a wind turbine is characterized through its *power coefficient*  $C_p$  that depends in a nonlinear way of two parameters which are the *tip speed ratio*  $\lambda$ , and the *pitch angle* of the blades  $\beta$  [10-12]. The tip speed ratio represents the ratio between the tangential speed of the blade

extremity  $\omega_{rotor} \cdot R$  and the speed of the wind  $v$

$$\lambda = \frac{\omega_{rotor} \cdot R}{v} \quad (1)$$

In this paper,  $C_p$  is calculated as

$$C_p(\lambda, \beta) = c_1 \cdot \left( \frac{c_2}{\lambda_i} - c_3 \cdot \beta^2 - c_4 \right) \cdot e^{\frac{-c_5}{\lambda_i} + c_6} \quad (2)$$

with  $\frac{1}{\lambda_i} = \frac{1}{0.4 + 0.5 \cdot \lambda}$  and the coefficients

$c_1$  to  $c_6$  being:  $c_1 = 0.18$ ,  $c_2 = 90$ ,  $c_3 = 115$ ,  $c_4 = 6.8$ ,  $c_5 = 8$  and  $c_6 = 0.16$ . Its variation with respect to  $\lambda$  and  $\beta$  is given in Figure 1.

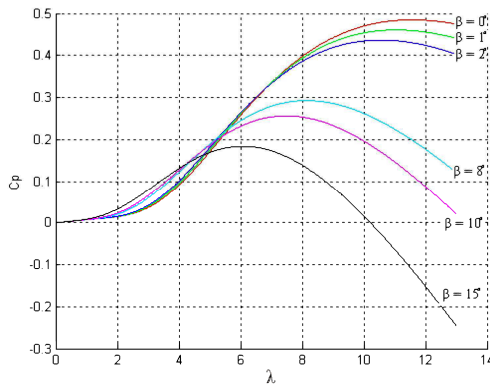

Figure 1 Power coefficient variation

The power coefficient,  $C_p$ , appears in the calculus of the aerodynamic torque  $C_{aero}$  and the extracted power  $P_{aero}$ :

$$C_{aero} = \frac{1}{2} \cdot \rho \cdot \pi \cdot R^2 \cdot C_p(\lambda, \beta) \cdot \frac{v^3}{\omega_R} \quad (3)$$

$$P_{aero} = \frac{1}{2} \cdot \rho \cdot \pi \cdot R^2 \cdot v^3 \cdot C_p(\lambda, \beta) \quad (4)$$

Another important coefficient of the turbine is the thrust coefficient  $C_a$  depending on the same two parameters, namely the tip speed ratio and the pitch angle, which define the thrust force  $F_{aero}$  exerted by the wind on the rotor of the turbine [4-5]:

$$F_{aero} = \frac{1}{2} \cdot \rho \cdot \pi \cdot R^2 \cdot C_T(\lambda, \beta) \cdot v^2 \quad (5)$$

The thrust coefficient is defined as

$$C_a(\lambda, \beta) = (0.0000188 \cdot \beta + 0.0000773) \cdot \lambda^3 + (-0.000821 \cdot \beta - 0.00521) \cdot \lambda^2 + (-0.00240 \cdot \beta + 0.1595) \cdot \lambda + 0.121 \cdot \beta - 0.25697 \quad (6)$$

and its variation with respect to  $\lambda$  and  $\beta$  is displayed in Figure 2.

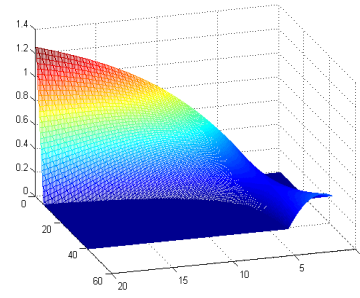

Figure 2 Thrust coefficient variation

A complex system can be easier studied if decomposed into subsystems, or its functioning regime is divided into several sub-regimes [6-7]. The wind turbine operation can be decomposed into three main operating zones depending on the speed of the wind. In Figure 3 one can find a typical power curve of a wind turbine.

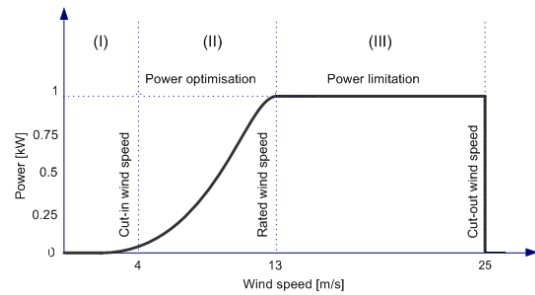

Figure 3 Wind turbine power curve

The functioning regimes are: a) *First Partial Load Area (I)*, b) *Second Partial Load Area (II)* and c) *Full Load Area (III)*.

The first zone comprises wind speeds that vary up to approximately  $4m/s$ . It is considered that below this value, the turbines consume much more energy that they manage to produce and in consequence they are not productive, therefore a turbine is started once wind surpasses this value of the wind speed.

In the second zone, ( $4-12m/s$ ), the turbine starts gradually to produce energy, and to become efficient. The focus falls on the maximization of the extracted power. One tries to determine the turbine to function at a maximal value of  $C_p$ . This value is also given by an optimal value of the tip-speed ratio  $\lambda_{opt}$  and of the pitch angle  $\beta_{opt}$ . The preferred control technique in this region is the torque method which varies the torque developed by the generator,  $C_{em}$ , based on measurements of the tip speed ratio with keeping the pitch angle constant at  $\beta_{opt}$ .

In the above rated wind speed (12-25m/s), also called high wind speeds area, the quantity of the electrical power delivered has to be limited to the nominal value of the generator in order to prevent its overheating. The most appealing control technique, called “pitch control” acts on the blades of the rotor, and it adjust them towards the feathered position, providing an effective control of the output power. The proposed control algorithm is designed for a wind turbine functioning in this regime.

## 2. Mathematical model of a wind turbine

The wind turbine structure can be represented as four interconnected subsystems: an aerodynamic, a mechanical, an electrical and a pitch subsystem. The wind turbine dynamics is described by the fundamental relation [5], [11]

$$M \cdot \ddot{q} + C \cdot \dot{q} + K \cdot q = Q(\dot{q}, q, t, u) \quad (7)$$

Here  $M$ ,  $C$  and  $K$  are the mass, damping and the stiffness matrices,  $Q$  is the vector of forces acting on the system, and  $q$  is the generalized coordinate vector. We have chosen  $q = (\omega_R, \omega_G, \zeta, y_T)$ , where  $\omega_R$ ,  $\omega_G$  stand for the angular speed of the rotor and generator respectively,  $\zeta$  models the bending of the blades and  $y_T$  represents the horizontal movement of the tower (Figure 4).

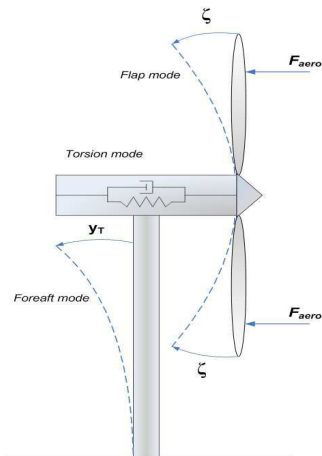

Figure 4 Oscillation modes of the turbine

The study was done under the supposition that the forces acting on both blades are equal; therefore their inclination under the wind pressure should be identical and equal to  $\zeta$ . The thrust force  $F_{aero}$ , applied to the

rotor produces the aerodynamic torque  $C_{aero}$  (3) that determines the rotational movement of the turbine. The vector of generalized forces becomes  $Q$  becomes:

$$Q = (C_{aero}, -C_{em}, F_{aero}, 2 \cdot F_{aero}) \quad (8)$$

where  $C_{em}$  is the electromagnetic torque developed by the generator [13]. The wind turbine model is obtained using the Lagrange equation [14]

$$\frac{d}{dt} \left( \frac{\delta E_c}{\delta \dot{q}_i} \right) - \frac{\delta E_c}{\delta q_i} + \frac{\delta E_d}{\delta \dot{q}_i} + \frac{\delta E_p}{\delta q_i} = Q \quad (9)$$

In the above equation,  $E_c$ ,  $E_d$ , and  $E_p$  denote the kinetic, dissipated and potential energies. The total kinetic energy accumulated by the system is given by

$$E_c = \frac{J_t}{2} \cdot \omega_k^2 + \frac{J_G}{2} \cdot \omega_G^2 + \frac{M_T}{2} \cdot \dot{y}_T^2 + M_p \cdot (\dot{y}_T + R \cdot \dot{\zeta})^2 \quad (10)$$

The total potential energy of the system is

$$E_p = \frac{k_A}{2} \cdot (\theta_R - \theta_G)^2 + k_p \cdot (R \cdot \zeta)^2 + \frac{k_T}{2} \cdot y_T^2 \quad (11)$$

and the dissipative energy is

$$E_d = \frac{d_A}{2} \cdot (\omega_R - \omega_G)^2 + d_p \cdot (R \cdot \dot{\zeta})^2 + \frac{d_T}{2} \cdot \dot{y}_T^2 \quad (12)$$

In (10)-(12),  $J_T$  and  $J_G$  represent the rotor and the generator moments of inertia,  $M_T$  and  $M_p$  are the masses of the tower and of the blade,  $d_p$ ,  $d_A$  and  $d_T$  represent the damping coefficients for the blade, drive shaft and tower. Similarly,  $k_p$ ,  $k_A$  and  $k_T$  stand for the spring coefficients of the blade, drive shaft and tower.  $\theta_R$  and  $\theta_G$  are the angular positions of the rotor and generator. The values of the turbine's parameters can be found in the Table given in the Annex. We will note the difference  $\theta_R - \theta_G$  with  $\theta_s$  which is the twist of the drive shaft.

The dynamics of the pitch actuator is modelled as a first order system [4, 5], [15]

$$\frac{\beta}{\beta_{ref}} = \frac{1}{1 + T_\beta \cdot s} \quad (13)$$

where  $\beta_{ref}$  is the desired pitch angle and  $\beta$  is the actual pitch angle of the blades. Every servomotor has some physical limitations, and we have modelled them by including saturations in position and in speed. For this study we assume that the saturation in

position varies between  $-45^\circ$  and  $45^\circ$ , and that the servomotor does not exceed the speed of  $10^\circ/\text{s}$  [16 -19]. The servomotor model used is given in Figure 5.

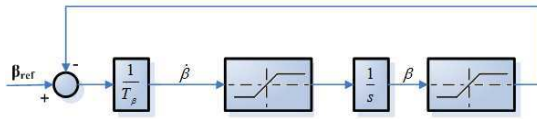

Figure 5 Pitch servomotor model

The nonlinearities of the aerodynamic torque and thrust force, together with the complexity of the different plant subsystems, give rise to a global highly non linear system. Applying the Lagrange equation for each component of  $q$  and  $Q$ , and taking into account (13), one obtains the wind turbine nonlinear model

$$\dot{x}(t) = f(x, t) + g(x, u, v, t) \quad (14)$$

where  $x = (\theta_s, \zeta, y_T, \omega_R, \omega_G, \dot{\zeta}, \dot{y}_T, \beta)^T$  is the system state vector and  $u = (\beta_{ref}, C_{em})$  is the control vector. The functions  $f$  and  $g$  are detailed in (15) and (16) where

$$M_f = \frac{(M_T + 2 \cdot M_P)}{M_P \cdot M_T}, \quad c_1 = \frac{1}{2} \cdot \rho \cdot \pi \cdot R^2.$$

$$f(x, t) = \begin{pmatrix} \dot{\theta}_s \\ \dot{\zeta} \\ \dot{y}_T \\ \frac{-d_A}{J_T} \cdot \dot{\theta}_s - \frac{k_A}{J_T} \cdot \theta_s \\ \frac{-d_A}{J_G} \cdot \dot{\zeta} + \frac{k_A}{J_G} \cdot \theta_s \\ -d_p \cdot M_f \cdot \dot{\zeta} - k_p \cdot M_f \cdot \zeta + \frac{d_T}{R \cdot M_T} \cdot \dot{y}_T + \frac{k_T}{R \cdot M_T} \cdot y_T \\ \frac{2 \cdot R \cdot d_p}{M_T} \cdot \dot{\zeta} + \frac{2 \cdot k_p \cdot R}{M_T} \cdot \zeta - \frac{d_T}{M_T} \cdot \dot{y}_T - \frac{k_T}{M_T} \cdot y_T \\ \frac{1}{T_\beta} \end{pmatrix} \quad (15)$$

$$g(x, u, v, t) = \begin{pmatrix} O_{3 \times 1} \\ \frac{1}{J_T} \cdot c_1 \cdot v^2 \cdot C_p(\lambda, \beta) \\ \frac{-C_{em}}{J_G} \\ \frac{(M_T - 2M_P)}{2 \cdot M_P \cdot M_T \cdot R} \cdot c_1 \cdot v^2 \cdot C_a(\lambda, \beta) \\ \frac{1}{M_T} \cdot c_1 \cdot v^2 \cdot C_a(\lambda, \beta) \\ \frac{1}{T_\beta} \cdot \beta_{ref} \end{pmatrix} \quad (16)$$

The system output vector  $y(t)$  includes the generated electrical power  $P_{el} = \omega_G \cdot C_{em}$  and

another three measured variables:  $\omega_R$ ,  $\zeta$  and  $y_T$ .

For control design purposes, the nonlinear model is linearized around the operating point  $S_{op} = (\omega_{R\ op}, \beta_{op}, v_{op}) = (8\text{rad/s}, 9^\circ, 17\text{m/s})$  and the following linear turbine model is obtained

$$\dot{x}(t) = A \cdot x(t) + B \cdot u(t) + E \cdot v(t) \quad (17)$$

$$y(t) = C \cdot x(t) + D \cdot u(t) \quad (18)$$

where the matrices  $A, B, E, C$  and  $D$  are given in the Annex.

### 3. Control system design and analysis

In this section a disturbance observer based linear quadratic controller is designed and analysed for the proposed horizontal variable speed wind turbine. The controller algorithm includes first an estimation of the system disturbances and then their rejection by an appropriately designed feedback. This control approach has the advantage of simplicity in design and enables obtaining information about the disturbances acting on the system [20, 21].

By modeling the wind speed variations through

$$\dot{v}(t) = \eta(t) \quad (19)$$

where  $\eta(t)$  is a zero-mean Gaussian white noise, and assuming the presence of output measurement white noise  $w(t)$ , one obtains the augmented system

$$\dot{x}_e(t) = A_e \cdot x_e(t) + B_e \cdot u(t) + E_e \cdot \eta(t) \quad (20)$$

$$y(t) = C_e \cdot x_e(t) + D \cdot u(t) + w(t) \quad (21)$$

with the state vector  $x_e(t) = [x(t) \ v(t)]^T$  and the corresponding augmented matrices  $A_e, B_e, E_e$  and  $C_e$ .

For the system (22), (23), an optimal controller is designed which minimizes the quadratic performance index

$$J = \lim_{T \rightarrow \infty} E \left\{ \frac{1}{T} \int_0^T (y^T \cdot Q \cdot y + u^T \cdot R \cdot u) \cdot dt \right\}$$

where  $Q$  and  $R$  are positive definite weighting matrices [22]. First, an optimal estimate  $\hat{x}_e$

of the state vector  $x_e$  is obtained using the Kalman-Bucy filter

$$\begin{cases} \dot{\hat{x}}_e = A_e \cdot \hat{x}_e + B_e \cdot u + L \cdot (y - C_e \cdot \hat{x}_e - D \cdot u) \\ L = P_f \cdot C_e^T \cdot W^{-1} \end{cases} \quad (22)$$

where  $P_f$  is the non-negative definite solution of the matrix Riccati equation

$$P_f \cdot A_e^T + A_e \cdot P_f - P_f \cdot C_e^T \cdot W^{-1} \cdot C_e \cdot P_f + E \cdot H \cdot E^T = 0$$

and  $W$  and  $H$  are the variances of the noises  $w(t)$  and  $\eta(t)$ . Then, the optimal control signal  $u^*(t)$  is computed by

$$u^*(t) = -K_e \cdot \hat{x}_e(t), \quad K_e = R^{-1} \cdot B^T \cdot P_c \quad (23)$$

where  $P_c$  is the non-negative definite solution of the Riccati equation

$$P_c \cdot A_e + A_e^T \cdot P_c - P_c \cdot B_e \cdot R^{-1} \cdot B_e^T \cdot P_c + C_e^T \cdot Q \cdot C_e = 0.$$

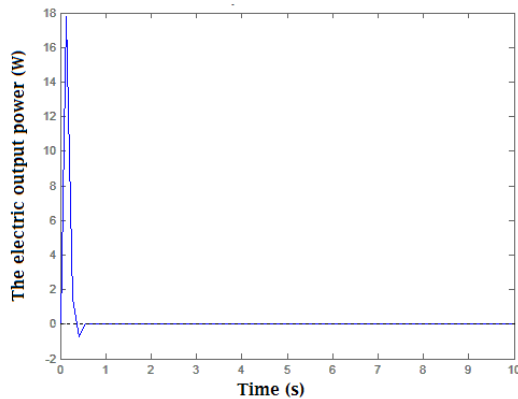

Figure 11 Response of the linear system

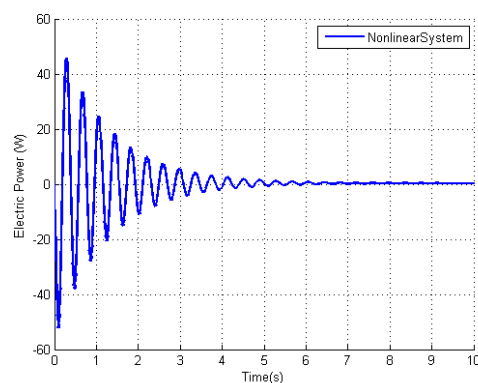

Figure 12 Response of the non linear system

The optimal controller design has been done for  $Q$ ,  $R$ ,  $W$  and  $H$  given in the Annex.

The performances of the optimal controller (22), (23) have been analysed by numerical simulations using Matlab/Simulink. For the linear and nonlinear turbine models, the results obtained for a wind speed of  $17m/s$  (disturbance of  $1m/s$ ) are given in Figure 11 and Figure 12, respectively.

To facilitate the comparison of the linear and nonlinear system responses, in Figure 12 the variation  $P_{el} - P_{el,nom}$  is shown. It can be seen that the nonlinear system response is more oscillatory than the linear system one, but in both cases the oscillation amplitude is insignificant with respect to the electrical power nominal value of  $400kW$ .

## 4. Conclusions

This paper presents the design and analysis of a disturbance observer based optimal linear quadratic controller for horizontal variable speed wind turbines. This controller is an alternative to the classical linear quadratic controller with integral action and has the advantage to give information about the system disturbances. A complex model of wind turbines has been considered, including the oscillating modes of the blades and tower. The simulations results obtained demonstrate the efficiency of the proposed controller in maintaining the output power level close to the nominal value of the generator.

## REFERENCES

1. NICHITA, C., D., Luca, B., Dakyo, E., Ceanga, **Large band simulation of the wind speed for real time wind turbine simulators**, IEEE Transactions on Energy Conversion, Vol.17, 2002.
2. NICHITA, C., D., Luca, B., Dakyo, E., Ceanga, N. A., Cutululis, **Modelling non stationary wind speed for renewable energy systems control**, The Annals of "Dunarea de Jos" University of Galati, Fascicle III, 2000.
3. LESCHER, F., P., Borne, **Robust gain scheduling controller for pitch regulated variable speed wind turbine**, Studies in Informatics and Control, Vol. 14, No. 4, 2005, pp 299-315.

4. LESCHER, F., J. Y., , Zhao, P., Borne, **Switching LPV controllers for a variable speed pitch regulated wind turbine**, International Journal of Computers Communications and Control, Vol. 1, No. 4, 2006, pp 75-86.
5. WAFI, J., N., Bouguila, A., Khendher, **State estimation via Observers with unknown inputs: application to a particular class of uncertain Takagi-Sugeno systems**, Studies in Informatics and Control, Vol. 19, issue 3, pp. 219-228, 2010.
6. MESAROVIC, M. D., D. Macko, Y., Takahara, **Theory of Hierarchical, Multilevel Systems**, Academic Press, New York, 1970.
7. FILIP, F. G., K., Leiviska, **Large scale complex systems**, Springer Handbook of Automation, (S.Y. Nof, Ed.), pp 619-638, Springer, Dordrecht, 2009.
8. KLEMPNER, G., I., Kerszenbaum, **Operation and maintenance of large turbo-generators**, Wiley Interscience, A John Wiley & Sons, Inc, Hoboken, New Jersey, USA, 2004.
9. BURTON, T., D., Sharpe, N., Jenkins, E., Bossanyi, **Wind energy handbook**, Wiley & Sons, Chichester, 2002.
10. HAU, E., **Wind turbines, fundamentals, technologies, and applications in economics**, 2<sup>nd</sup> edition, Springer-Verlag, Berlin, 2006, pp. 103.
11. MUNTEANU, I., A., I., Bratcu, N., A., Cutululis, E., Ceanga, **Optimal control of wind energy systems – Towards a global approach**, Springer-Verlag, London, 2008.
12. LIM, C.W., K. Y., Seo, **A comparative study on responses in the optimal region according to torque control methods for wind turbines**, Proceedings of the International Conference on Control Automation and Systems, Kintex, Gyeonggi-do, Korea, 2010, pp. 1066-1072.
13. KASPER, Z. O., **Robust gain scheduled control of wind turbines**, Phd Thesis, Automation and Control Department of Electronic Systems, Aalborg University, Denmark, 2008.
14. ARCZEWSKY, K., W., Blajer, J., Fraczek, M., Wojtyra, **Multi-body dynamics**, **Computational methods in applied sciences**, Springer Verlag, Dordrecht, 2010.
15. JAIN, P., **Wind energy engineering**, McGrawHill, New York, 2011.
16. SPERA, D., A., **Wind turbine technology, fundamental concepts of wind turbine engineering**, 2<sup>nd</sup> Edition, Asme Press, New York, 2009.
17. KUTZ, M., **Mechanical Engineers' Handbook, Materials and Mechanical design**, John Wiley & Sons, Inc., New York, 2006.
18. BIANCHI, F., H., Battista, R., Mantz, **Wind turbine control systems – Principles, modeling, and gain scheduling design**, Springer-Verlag, Berlin, 2007.
19. MITA, T., M., Hirata, K., Murata, H., Zhang, **H $\infty$  control versus disturbance observer based control**, IEEE Transactions on Industrial Electronics, Vol. 45, June, 1998, pp 488-495.
20. CHEN, W., H., **Disturbance observer based control for nonlinear systems**, IEEE/ASME Transactions on mechatronics, Vol. 9, No. 4, Dec., 2004, pp 706-711.
21. SIMON, D., **Optimal state estimation – Kalman, H $\infty$ , and nonlinear approaches**, Wiley Interscience, Hoboken, New Jersey, 2006.
22. ZHOU, K., Doyle J., Glover K., **Robust and optimal control**, Prentice Hall, Englewood Cliffs, 1995.

## ANNEX

Matrices of the linear wind turbine model

$$A = \begin{pmatrix} -5.55 & 0 & 0 & 0 & 0 & 0 & 0 & 0 \\ 0 & 0 & 1 & -1 & 0 & 0 & 0 & 0 \\ -1.9 & -51.4 & -0.38 & 0.28 & 0 & 0 & 0 & 0 \\ 0 & 268.29 & 1.46 & -1.46 & 0 & 0 & 0 & 0 \\ -0.02 & 0 & 0.024 & 0 & -3.9 & -390.47 & 14.28 & 0.08 \\ 0 & 0 & 0 & 0 & 1 & 0 & 0 & 0 \\ 0 & 0 & 0 & 0 & 0 & 0 & 0 & 1 \\ -0.07 & 0 & 0.08 & 0 & 9.71 & 971.42 & -242.85 & -1.42 \end{pmatrix}$$

$$B = \begin{pmatrix} 5.55 & 0 & 0 & 0 & 0 & 0 & 0 & 0 \\ 0 & 0 & 0 & -2.43 \cdot 10^{-5} & 0 & 0 & 0 & 0 \end{pmatrix}^T$$

$$C = \begin{pmatrix} 0 & 0 & 1 & 0 & 0 & 0 & 0 & 0 \\ 0 & 0 & 0 & 50000 & 0 & 0 & 0 & 0 \\ 0 & 0 & 0 & 0 & 0 & 1 & 0 & 0 \\ 0 & 0 & 0 & 0 & 0 & 0 & 0 & 1 \end{pmatrix}$$

$$D = \begin{pmatrix} 0 & 0 & 0 & 0 \\ 0 & 8 & 0 & 0 \end{pmatrix}^T$$

$$E = (0 \ 0 \ 0.078 \ 0 \ 0.072 \ 0 \ 0 \ 0.256)^T$$

Values of the wind turbine parameters

Symbol	Physical meaning	Measurement units
$J_t$	Turbine inertia	214 000 Kg * m <sup>2</sup>
$J_g$	Generator inertia	41 Kg * m <sup>2</sup>
$M_T$	Tower and nacelle mass	35000 kg
$M_p$	Blade mass	3000 kg
$k_p$	Blade Stiffness Coefficient	1000 Kg* m <sup>2</sup> /s <sup>2</sup>
$k_T$	Tower Stiffness Coefficient	8500 Kg* m/s <sup>2</sup>
$k_A$	Drive Shaft Stiffness Coefficient	11000 Kg* m <sup>2</sup> /s <sup>2</sup>
$d_p$	Blade Damping coefficient	10 000 Kg* m <sup>2</sup> /s
$d_T$	Tower Damping coefficient	50 000 Kg* m/s
$d_A$	Drive shaft damping coefficient	60 000 Kg* m <sup>2</sup> /s
$N$	Number of blades	2
$D$	The rotor diameter	34 m
$P_n$	Nominal Power	400 kW
$\omega_{R,nom}$	The nominal angular velocity of the rotor	4 rad/s

$$Q = \begin{pmatrix} 0.01 & 0 & 0 & 0 \\ 0 & 0.1 & 0 & 0 \\ 0 & 0 & 0.1 & 0 \\ 0 & 0 & 0 & 1 \end{pmatrix}$$

$$R = \begin{pmatrix} 0.01 & 0 \\ 0 & 0.0001 \end{pmatrix}$$

$$W = \begin{pmatrix} 0.0001 & 0 & 0 & 0 \\ 0 & 0.0001 & 0 & 0 \\ 0 & 0 & 0.0001 & 0 \\ 0 & 0 & 0 & 0.0001 \end{pmatrix}$$

$$H = 0.0001$$

Weighting matrices and noise variances used in the optimal controller design