



HAL
open science

Effect of sealed anodic film on fatigue performance of 2214-T6 aluminium alloy

Majid Shahzad, Michel Chaussumier, Rémy Chieragatti, Catherine Mabru,
Farhad Rezai-Aria

► **To cite this version:**

Majid Shahzad, Michel Chaussumier, Rémy Chieragatti, Catherine Mabru, Farhad Rezai-Aria. Effect of sealed anodic film on fatigue performance of 2214-T6 aluminium alloy. *Surface and Coatings Technology*, 2012, vol. 206, pp.2733-2739. hal-00714350

HAL Id: hal-00714350

<https://hal.science/hal-00714350>

Submitted on 4 Jul 2012

HAL is a multi-disciplinary open access archive for the deposit and dissemination of scientific research documents, whether they are published or not. The documents may come from teaching and research institutions in France or abroad, or from public or private research centers.

L'archive ouverte pluridisciplinaire **HAL**, est destinée au dépôt et à la diffusion de documents scientifiques de niveau recherche, publiés ou non, émanant des établissements d'enseignement et de recherche français ou étrangers, des laboratoires publics ou privés.



Open Archive Toulouse Archive Ouverte (OATAO)

OATAO is an open access repository that collects the work of Toulouse researchers and makes it freely available over the web where possible.

This is an author-deposited version published in: <http://oatao.univ-toulouse.fr/>
Eprints ID: 5871

To link to this article: DOI: 10.1016/j.surfcoat.2011.10.033

URL: <http://dx.doi.org/10.1016/j.surfcoat.2011.10.033>

To cite this version: Shahzad, Majid and Chaussumier, Michel and Chieragatti, Rémy and Mabru, Catherine and Rezaï-Aria, Farhad *Effect of sealed anodic film on fatigue performance of 2214-T6 aluminium alloy*. Surface and Coatings Technology, vol. 206 (n° 11-12). pp. 2733-2739. ISSN 0257-8972

Any correspondence concerning this service should be sent to the repository administrator: staff-oatao@inp-toulouse.fr

Effect of sealed anodic film on fatigue performance of 2214-T6 aluminum alloy

Majid Shahzad ^a, Michel Chaussumier ^{a,*}, Rémy Chieragatti ^a, Catherine Mabru ^a, Farhad Rezai-Aria ^b

^a Université de Toulouse, ISAE, Département Mécanique des Structures et Matériaux (ICA) 10-Avenue Edouard Belin, 31055 Toulouse Cedex 4, France

^b Université de Toulouse, Ecoles des Mines d'Albi (ICA), Campus Jarlard, F-81013 Albi, France

A B S T R A C T

The aim of present study is to investigate the influence of anodic film, grown by sulfuric acid anodizing and sealed in nickel-acetate solution, on fatigue strength of aluminum alloy 2214-T6 by conducting axial fatigue tests at stress ratio 'R' of 0.1 and -1 . The influence of sealed anodic film is to degrade the stress-life (*S-N*) fatigue performance of the base material at all stress levels. Effects of pre-treatments like degreasing and pickling employed prior to anodizing were also studied and no influence of these pre-treatments was observed on fatigue life. The surface and cross-section observations of anodic film were made by scanning electron microscope (SEM) before and after fatigue tests. The surface observations have revealed cavities which resulted from dissolution of coarse Al_2Cu particles during anodization and network of micro-cracks on anodic film surface which were initiated as a result of sealing process. Some of these micro-cracks were found to penetrate up-to substrate and have detrimental effect on subsequent fatigue strength. The decrease in fatigue life for anodized-sealed specimens as compared to bare condition has been attributed to decrease in initiation period and multi-site crack initiations. Multi-site crack initiation has resulted in rougher fractured surfaces for the anodized specimens as compared to bare specimens tested at same stress levels.

Keywords:
Fatigue
Anodic film
Sealing
SEM
Micro-cracks

1. Introduction

Combination of high strength and low density with good corrosion resistance makes aluminum alloys suitable to be used in aeronautical industry to manufacture different structural components. When exposed to air, a layer of natural oxide is formed on their surface but this layer does not provide sufficient corrosion resistance in many environments. Hence aluminum alloys are often anodized to enhance corrosion resistance [1]. It is often preferred to other surface treatments due to excellent adhesion of the protective layer to the substrate inherent to the process: indeed, anodization process consists in the artificial growth of oxide layer from the substrate, leading to better adhesion compared to coating process where other material is deposited on the substrate. The anodic film thus formed is composed of a compact inner layer and a porous outer layer [2] and due to this porous structure, anodic film is susceptible to aggressive environments. Therefore, this porous anodic film is sealed by different methods like boiling water, nickel acetate and dichromate solutions [3–4] to further improve the corrosion resistance. Despite the benefits obtained in terms of enhanced corrosion properties, the anodic film has a detrimental effect on the fatigue performance of the base material [5–8] in particular by promoting crack initiation. The anodization produces a brittle and hard oxide layer as compared to aluminum substrate,

with inherent pores, and it easily cracks under cyclic stress. Sadeler [6] performed fatigue tests on 2014 aluminum alloy which has been hard anodized and reported that the fatigue cracks nucleated within the hard coating and then propagated towards the substrate. Rateick et al. [7] showed that anodization of wrought 6061-T6 alloy gave rise to an appreciable reduction in fatigue strength (60% debit) and the presence of cracks throughout the film is responsible for this degradation. They also reported that in case of cast C355-T6, anodization did not affect the fatigue strength significantly. Camargo et al. [9] have shown that internal tensile residual stresses, as a consequence of anodization on 7050-T7451, is one of the reasons for degrading stress-life fatigue performance of the substrate. Study by Cree and Weidmann [10] on anodized 2024 alloy has demonstrated that fatigue crack growth rate can be significantly enhanced in the presence of thin anodic film. They explained the increased growth rate in terms of possible tensile residual stress in film and its inherent higher modulus.

To summarize, the detrimental effect of anodization on aluminum alloy is, in the literature, often attributed to residual stress and/or brittle layer easy to crack depending on the composition of the alloy. However, there is little scientific knowledge about the effect of sealing process on the fatigue behavior of anodized aluminum alloys. In this context, the objective of the present paper is to quantify the fatigue strength for high and middle stress level of the aluminum alloy 2214-T6 anodized in sulfuric acid and sealed in nickel-acetate solution and to identify the crack nucleation mechanism. Moreover, constituent particle sizes and distributions can be different for longitudinal L, long transverse T and short transverse S directions which, in

turn, can affect the morphology of anodic film and hence fatigue strength. However, in this article specimens have been machined in the rolling 'L' direction and subsequent fatigue strength has been evaluated. Optical and scanning electron microscope coupled with energy dispersive spectroscopy (EDS) were used to analyze the anodic film appearance and fracture surface of fatigue specimens to identify the crack origin sites and to understand the damage mechanism.

2. Experimental details

2.1. Material

The tested material for this work is 2214-T6 which has been heat-treated, quenched (at 494 °C for 9 h) and finally artificially aged (at 178 °C for 10 h) [11]. The chemical composition of the alloy, as determined by EDS technique, is given in Table 1.

Metallographic analysis of the microstructure by optical microscope revealed that it is composed of unrecrystallized and recrystallized grains and latter are elongated in the rolling direction as shown in Fig. 1. Two types of constituent particles were found in this material: Al_2Cu and $AlSiMnFeCu$ and their average size varied between 8 and 12 μm . These types of particles have also been reported earlier [12] for the given alloy. Microstructure was also analyzed by SEM and it was observed that some of the constituent particles of second type ($AlSiMnFeCu$) had cracks prior to any fatigue loading.

Mechanical properties of the alloy in the rolling direction, as determined by tensile tests, are: yield strength 415 MPa, ultimate tensile strength 468 MPa, Young's modulus 73.4 GPa and elongation 11.8%.

2.2. Specimen preparation

Fatigue test specimens have been designed according to the useful fastening system of the fatigue testing machine and to prevent buckling of the shaft of the specimen during fatigue tests under stress ratio of -1 . Connection profiles have been sized in order to reach a stress concentration factor ' K_t ' of 1.04 [13]. Geometry of specimens is shown in Fig. 2. Surface of specimens has been machined with initial surface roughness $R_a = 0.7 \pm 0.1 \mu m$ by lathe turning with the rolling axis parallel to loading axis without using lubricant. The initial roughness of 0.7 μm is deliberately produced to mimic the surface roughness generated for components used by industrial partner.

2.3. Surface treatments

Surface treatment has been performed by the industrial partner. Prior to anodizing, the specimens were degreased and pickled in phosphoric acid solution (60 g/L) at 45 °C for 5 min. Anodizing was carried out in sulfuric acid solution (200 g/L) at 18 °C for 25 min. After anodizing, the specimens were rinsed in deionized water. Finally, after anodizing, the specimens were sealed in nickel-acetate solution at 98 °C for 20 min.

The thickness of anodic film was measured by optical microscopy and was also confirmed by SEM inspection. The average thickness of film produced by the process is measured to be about 6 μm .

The surface and cross sectional observations of sealed anodic film were made with SEM before conducting fatigue tests. For the cross-section micrographs, specimens were wire-cut in the middle and were polished up to 2400 grit SiC abrasive papers using standard metallographic technique.

Table 1
Chemical composition of 2214-T6 alloy.

Element	Si	Fe	Cu	Mn	Mg	Cr	Zn	Zr	Al
Weight%	0.64	0.19	4.20	0.32	0.86	0.15	0.28	0.16	Bal.

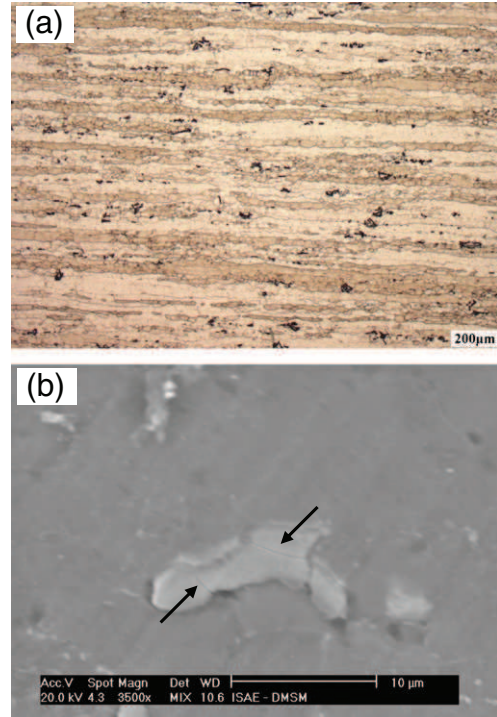

Fig. 1. (a) Optical micrograph of 2214-T6 aluminum alloy microstructure and (b) Cracked particle observed prior to fatigue loading.

2.4. Fatigue testing

To obtain $S-N$ curves, axial fatigue tests have been performed at 10 Hz in ambient conditions at stress ratio $R = -1$ and 0.1 according to ASTM E 466 [14]. All tests were conducted under load controlled condition using a 100 kN servo-hydraulic MTS machine. The nominal maximum cyclic stress was set at a value that was expected to result in a fatigue life of between 10^4 and 10^6 cycles. Therefore, the maximum stress varied between groups of specimens and tests were stopped if specimen did not fail at 1.2×10^6 cycles. Analysis of the results was performed with the least square method applied to the Stromeyer model ($\sigma^{\max} = E + \frac{A}{N^\gamma}$). In the case of the as machined specimens under stress ratio -1 , the material parameters values E , A and γ are respectively equal to 212 MPa, 36426 and 0.520 and the estimation s of the standard deviation is equal to 7.3 MPa. This very low value traduces a very low scattering of the experimental results. In the case of stress ratio 0.1, the material parameters are respectively equals to 105 MPa, 1677 and 0.234 with a standard deviation s of 4.4 MPa.

3. Results and discussions

3.1. SEM observations of pickled specimens

The long pickling time prior to anodization could result in the formation of pits with significant fatigue life implications [15]. Also in the previous work for 7010-T7451 aluminum alloy, Shahzad et al. [16] have shown that pickling process reduced the fatigue life considerably. In fact, in that previous case, pickling process used in [16] was found to attack constituent particles resulting in pits at surface which in turn acted as stress concentration facilitating crack initiation and subsequent crack growth. Therefore, microscopic examination was made after pickling process to verify that if this changes the surface topography of the specimen. Concerning present 2214-T6 aluminum alloy, comparison of micrographs (Fig. 3a and b) before and after pickling process, allows us to say that pickling process did not change

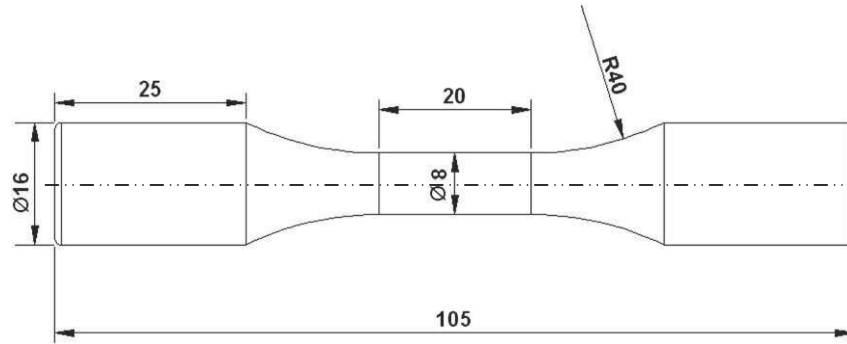

Fig. 2. Fatigue specimen geometry (dimensions in mm).

the surface topography of the specimens. Moreover, EDS analysis showed that constituent particles Al_2Cu and $AlSiMnFeCu$ were always present for the pickled specimens.

3.2. SEM observations of sealed anodic film

Fig. 4 reveals the surface and cross-section micrographs of the sealed anodic film before any fatigue loading and cracks are visible both on the surface and on the cross-section of the film. In their work on 7175 alloy, Goueffon et al. [17] have shown that development of the cracks throughout anodic film is attributed to the sealing process and associated with the release of residual stresses which were present as a result of anodization. Continuity detection has shown (Fig. 4b) that some of these cracks have penetrated up to substrate prior to any fatigue loading. The presence of a crack in anodic film may promote failure of the substrate under conditions where surface initiation of cracks is deleterious, as for example in high cycle fatigue. These cracks can act like stress raiser during fatigue

loading and can significantly affect the fatigue life by reducing or even eliminating the initiation period. Otherwise, irregularities of the sealed-anodized surface have been observed as shown in Fig. 4(c) and (d). Large and connected particles, present at surface, were observed to cause corresponding bigger irregularities or cavities (Fig. 4c). The presence of these cavities or macro-pores can be explained by the preferential or complete dissolution of constituent particle Al_2Cu during anodization in sulfuric acid bath [12]. Dissolution of Al_2Cu particles affected the surface appearance of the anodic film around the particles.

3.3. S-N curves

To further validate the fact that pickling has no effect on fatigue behavior of this alloy, some specimens were tested in pickled conditions and results presented in Fig. 5 showed no change in fatigue life as compared to machined specimens.

Fatigue test results for bare and coated specimens are given in Figs. 6 and 7 for $R=0.1$ and -1 respectively. It can be clearly seen that tendency of sealed anodic film is to degrade the fatigue performance for the given alloy at all stress levels as compare to bare specimens. For fatigue life of 10^6 cycles, there is a decrease of 35% for $R=0.1$ and 41% for $R=-1$. It can be noted that the fatigue strength of anodized coated specimens showed a dependency on the applied stress ratio. However, the presence of anodic film did not modify significantly the effect of stress ratio as shown in Fig. 8 on which Haigh diagram has been established for 10^6 cycles for machined and anodized specimens: the slope for the two segments did not change significantly: -0.418 for machined and -0.394 for anodized specimens.

From Figs. 6 and 7, one can note that with the increase in the applied stress amplitude, S-N curves tend to converge thus reducing the negative effect of the anodic film. This behavior of convergence for high stress can be observed for both stress ratios. One possible explanation for this phenomenon may be the differences in relative importance of crack nucleation versus crack propagation in high and low stress regimes. Indeed, fatigue life is essentially divided into two regions: crack nucleation life (dominant for low stresses) and crack propagation life (dominant for high stresses). In addition, as the anodic film is significantly thin compared to the total section of the specimen, a pronounced effect of film on fatigue crack growth behavior and hence on fatigue crack propagation life would not be expected: this results in a slighter effect of the film for high stresses. On the other hand, crack nucleation is known to be sensitive to surface condition. Therefore, the anodic film would be expected to influence fatigue nucleation life and hence fatigue lives at low stresses more significantly.

The substrate and anodic film interface for 2214-T6 alloy submitted to a sulfuric surface treatment, shown in Fig. 4 before any fatigue loading, helps in understanding the strong effect of the treatment on fatigue strength for this alloy. In the Fig. 4, it is possible to observe many

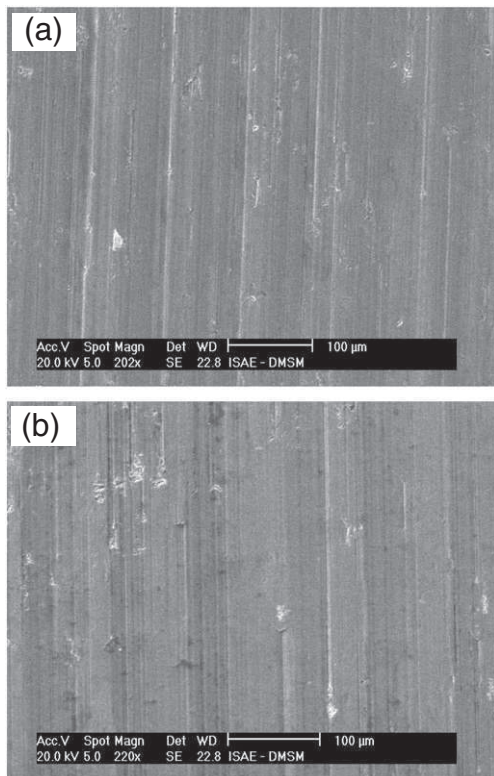

Fig. 3. (a) SEM micrograph of the surface of machined specimen and (b) SEM micrograph of the surface of pickled specimen.

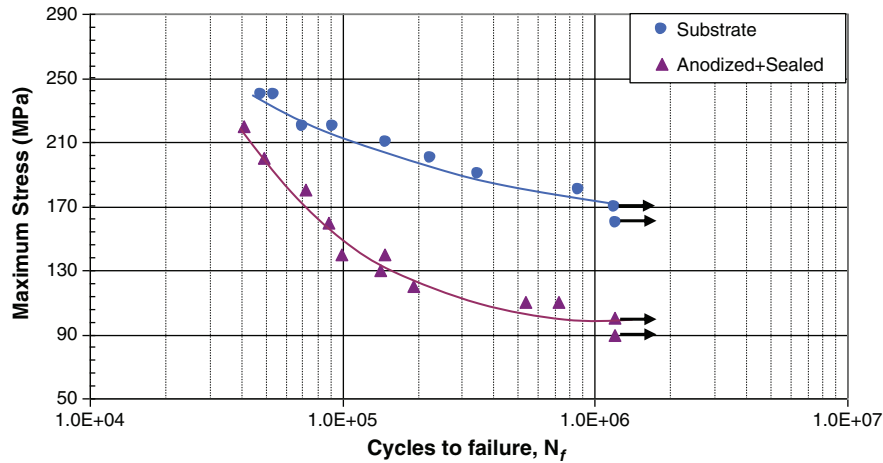

Fig. 7. S-N curves for bare and anodized specimens at stress ratio, $R = -1$.

irregularities, cavities which resulted as dissolution of Al_2Cu particles and already developed micro-cracks as a result of sealing process, produced by the treatment, which were found along the perimeter of the sample. Also fatigue loss could be attributed to the brittle nature and higher modulus [18] of the anodic film, which readily cracks when loaded. Since oxide layer adheres extremely well to substrate, any crack that develops in it acts like stress raiser and propagates towards the substrate. Considering that residual stresses are released by the development of these micro-cracks throughout the film [17], the decrease in fatigue performance for coated specimens is more likely attributed to defects present in anodic film rather than internal tensile residual stresses as observed by [9].

3.4. Fractography

Several specimens tested at different stress levels were examined after failure by SEM, using backscattered and secondary electrons, in order to understand the different fatigue damage behaviors for machined as well as anodized conditions. Fatigue test results presented above indicate that the decrease in fatigue strength of anodized specimens was related to the crack initiation stage. Therefore, it is important to identify the origin of fatigue cracks for different specimens. For aluminum alloys, constituent particles and grain boundaries are the common sites for fatigue crack initiation [19]. For the specimens tested in as machined and pickled condition, fatigue cracks have been observed to nucleate at constituent particles $AlSiMnFeCu$, as determined by EDS technique, and Al_2Cu particles were not effective in initiating cracks. Almost all of

the fatigue cracks were initiated by the cracking of the constituent particle ($AlSiMnFeCu$) and there was no evidence of debonding at the interface of matrix/particle (Fig. 9).

The sealed anodized specimens exhibited various fatigue crack initiation points, which propagated resulting in fracture. For most of the anodized specimens, cracks developed in the film and then propagated towards the substrate. Such mechanism is shown in Fig. 10, which presents the fractured surface of one of the anodized specimen tested at 180 MPa.

Besides the cracking of anodic film, the presence of pit like defects (cavities) in the film was also found to be another source of crack initiation for substrate as can be seen in Fig. 11. These pits may cause local stress concentration and may have a provocative effect on the subsequent cracks growth in the substrate. The phenomenon of initiation from cracking of film and cavities was observed for both stress ratios. For anodized specimens, the main controlling factor for crack initiation appears to have been provided by the film. Constituent particles ($AlSiMnFeCu$) played no role in fatigue crack initiation in the anodized specimens.

At the same stress level, the number of cracks formed on fractured surface of the anodized specimens was larger than that of the untreated specimens as indicated by arrows in Fig. 12. The fracture surface is not flat (Fig. 12b) which also reveals that number of fracture steps exists, indicating that fracture has occurred as a consequence of the propagation of several cracks that initiated from film. Shiozawa et al. [20] have also demonstrated this phenomenon that number of crack initiation sites increased for the anodized specimens

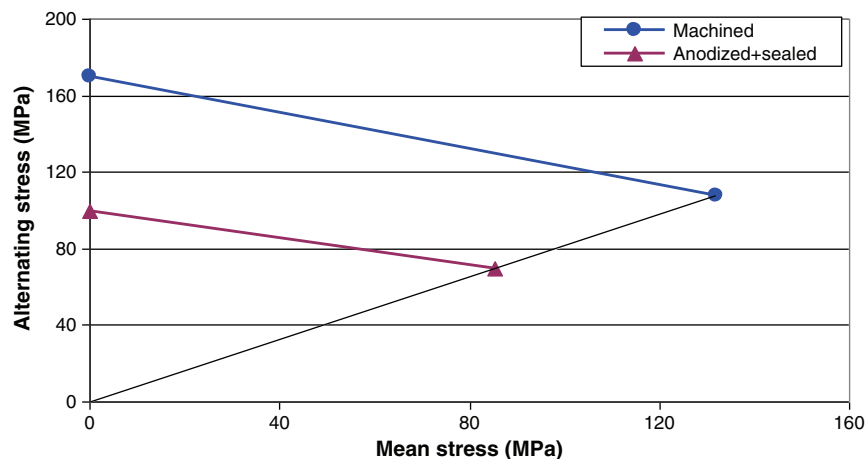

Fig. 8. Haigh diagram to evaluate the effect of mean stress at 10^6 cycles between machined and anodized specimens.

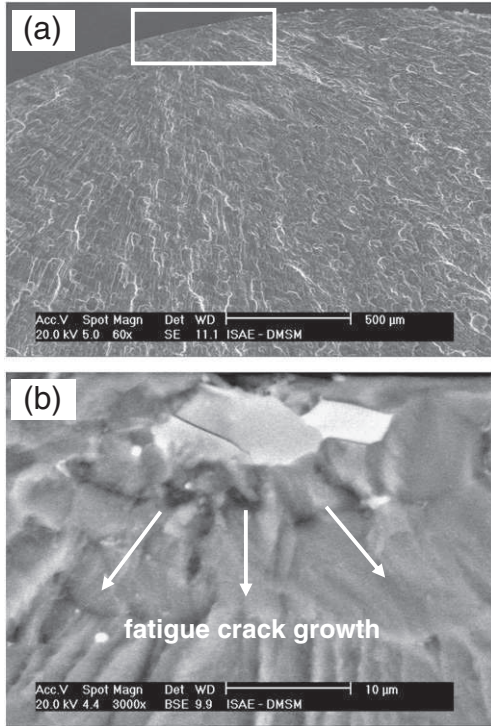

Fig. 9. (a) SEM image for bare specimen at low magnification showing crack initiation site and (b) higher magnification of (a) showing cracking of particle and subsequent fatigue crack growth.

compared to untreated ones. For the anodized specimens, cracks at the multiple initiation sites propagated independently and coalesced with neighboring cracks. Therefore, one can also conclude that decrease in fatigue strength of anodized specimen is caused by the

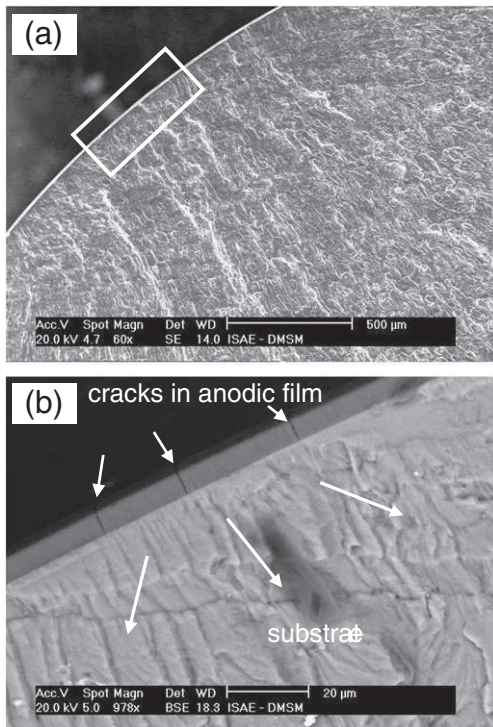

Fig. 10. Fracture surfaces of anodized specimen ($R = 0.1$), at low and high magnification showing fatigue cracks initiated within the film and propagated towards substrate.

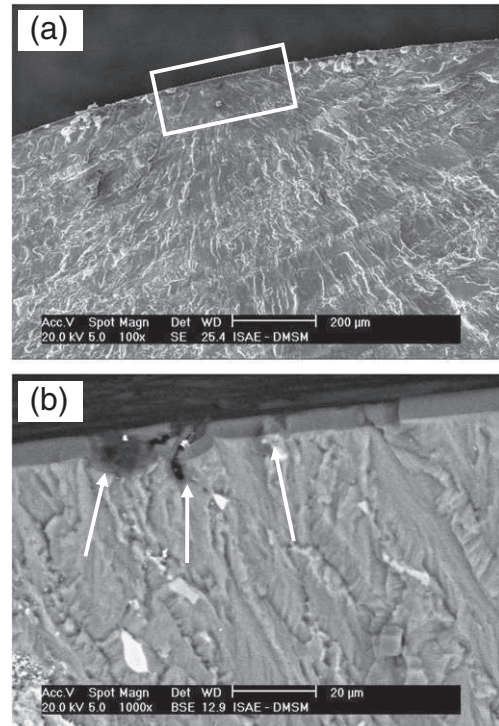

Fig. 11. SEM images of anodized specimen; $R = -1$, $\sigma_{max} = 200$ MPa, $N_f = 51025$ cycles at low and high magnification showing the crack initiation from cavities in film.

increase in number of crack initiation sites and higher crack propagation rates due to coalescence of cracks.

Some fractured anodized specimens were also examined at their surface to study the secondary cracks and to find their source of

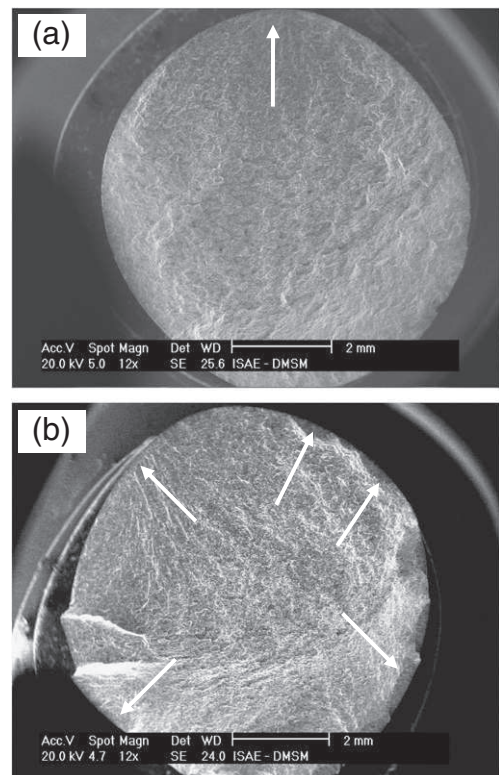

Fig. 12. (a) Bare specimen showing single crack initiation; $\sigma_{max} = 260$ MPa, $N_f = 219640$ cycles (b) anodized specimen showing multi-site initiation, $\sigma_{max} = 260$ MPa, $N_f = 61548$ cycles.

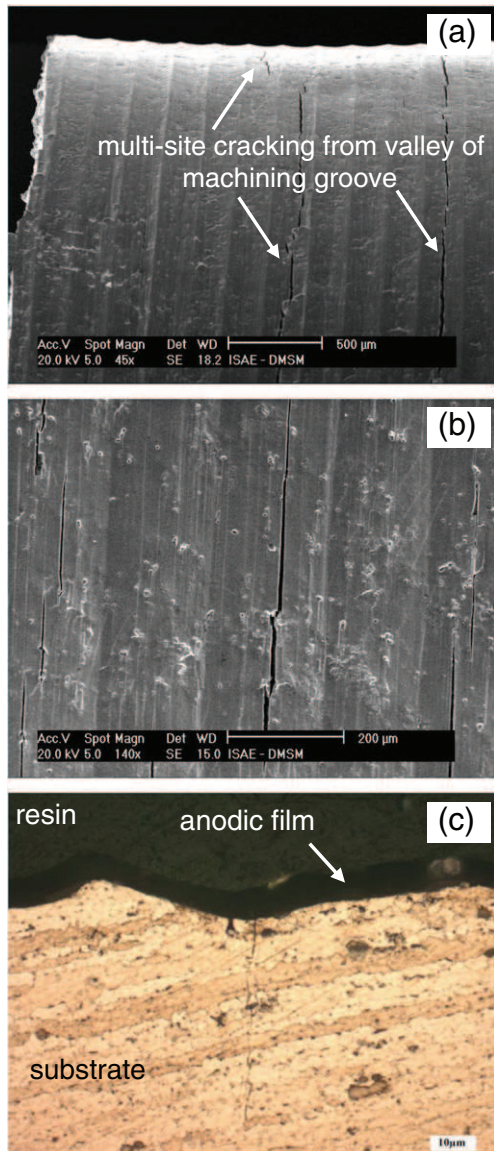

Fig. 13. (a) and (b) Secondary cracks on anodized specimen surface showing multi-site initiation at low and high magnification (c) transversal section image showing fatigue cracking in anodized specimen.

initiation. Fig. 13 shows that most of the secondary fatigue cracks were initiated at the valley of machined groove and started from pit like defects. To validate the fact that anodic film follows the machined surface profile, one fatigue tested specimen was cut along the long axis of the specimen. Then specimen was polished using diamond paste of 1 μm. Optical image shows that anodic film has followed the machined surface profile.

4. Conclusions

The fatigue behavior of 2214 alloy has been investigated for machined (bare), degreased and pickled, and anodized and sealed specimens. The SEM observations revealed the presence of cavity like defects and crazing in the sealed anodic film before any fatigue

loading. However, degreasing and pickling do not affect the surface morphology. The fatigue test results indicated no effect of pre-treatment on fatigue behavior while anodic film reduces the fatigue performance of the substrate. For fatigue life of 10^6 cycles, there is a decrease of 35% for $R = 0.1$ and 41% for $R = -1$ concerning the maximum stress.

In the bare conditions, fractographic examination showed that crack initiation was associated with constituent particle (AlSiMn-FeCu) cracking and there was no evidence of matrix/particle debonding. The damage mechanism observed for pickled specimens is the same as that of machined (bare) specimens. The microscopic aspect of fracture surface for anodized specimens shows a dual micro-mechanism of failure, with some crack initiation sites started by the multi-cracking of the anodic film and some are initiated at the cavities present in the film. The fact that no constituent particles were found at initiation sites indicates that the film provided the dominant discontinuities. Another difference observed for the anodized and sealed specimens was the presence of multiple crack initiation sites on the fracture surfaces. The decrease in fatigue life could also be attributed to the increase of crack initiation sites. The fracture surface was not flat, revealing the presence of a number of fracture steps, which points out that fracture has occurred as a consequence of the propagation of several cracks that initiated from the surface of coated specimens.

Acknowledgment

The authors would like to acknowledge Messier-Bugatti (France) for providing material and preparation of the anodized specimens. One of the authors, Majid Shahzad wishes to acknowledge the financial support of Higher Education Commission (Pakistan) for the research work.

References

- [1] ASM International Handbook Committee, ASM Handbook, 9th edition, Corrosion, vol. 13, ASM International, USA, 1998.
- [2] G.E. Thompson, G.C. Wood, in: J.C. Scully (Ed.), Treatise on materials science and technology, Corrosion: Aqueous Processes and Passive Films, Vol. 23, Academic Press, New York, 1983, p. 205.
- [3] S. Wernick, R. Pinner, P. Sheasby, Surface Treatment and Finishing of Aluminium and its Alloys, 6th edition Finishing Publications Ltd, England, 2001.
- [4] L. Hao, B.R. Cheng, Met. Finish. 12 (2000) 8.
- [5] B. Lonyuk, I. Apachitei, J. Duszczuk, Surf. Coat. Technol. 201 (2007) 8688.
- [6] R. Sadeler, J. Mater. Sci. 41 (2006) 5803.
- [7] R.G. Rateick, T.C. Binkowski, B.C. Boray, J. Mater. Sci. Lett. 15 (1996) 1321.
- [8] E. Cirik, K. Genel, Surf. Coat. Technol. 202 (2008) 5190.
- [9] J.A.M. Camargo, H.J.C. Voorwald, M.O.H. Cioffi, M.Y.P. Costa, Surf. Coat. Technol. 201 (2007) 9448.
- [10] A.M. Cree, G.W. Weidmann, J. Surf. Eng. 13 (1997) 51.
- [11] Military Specification MIL-H6088G, Heat treatment of Aluminium Alloys, Department of Defence, USA, 1991.
- [12] F. Snogan, C. Blanc, G. Mankowski, Surf. Coat. Technol. 154 (2002) 94.
- [13] R.E. Peterson, Stress Concentration Factors, Wiley, New York, 1974.
- [14] ASTM E466-07, Standard practice for conducting force controlled constant amplitude axial fatigue tests of metallic materials.
- [15] E. Abramovici, P. Leblanc, B. Weaver, The influence of etch pits on fatigue life of anodized aluminium alloys, 1991, p. 21.
- [16] M. Shahzad, M. Chaussimier, R. Chieragatti, C. Mabru, F.R. Aria, J. Mater. Process. Technol. 210 (2010) 1821.
- [17] Y. Goueffon, C. Mabru, M. Labarrère, L. Arurault, C. Tonon, P. Guigue, Surf. Coat. Technol. 204 (2009) 1013.
- [18] A. Merati, G. Eastaugh, Eng. Fail. Anal. 14 (2007) 673.
- [19] P.J. Laz, B.M. Hillberry, Int. J. Fatigue 20 (1998) 263.
- [20] K. Shiozawa, H. Kbayashi, M. Terada, A. Matsui, Effect of Anodized Films on Fatigue Strength in Aluminium Alloy, 2001, p. 397.