



**HAL**  
open science

## **Gear impacts and idle gear noise: Experimental study and non-linear dynamic model**

Jean-Luc Dion, Sylvie Le Moyne, Gaël Chevallier, Hamidou Sebbah

► **To cite this version:**

Jean-Luc Dion, Sylvie Le Moyne, Gaël Chevallier, Hamidou Sebbah. Gear impacts and idle gear noise: Experimental study and non-linear dynamic model. *Mechanical Systems and Signal Processing*, 2009, 23 (8), pp.2608-2628. 10.1016/j.ymssp.2009.05.007 . hal-00708792

**HAL Id: hal-00708792**

**<https://hal.science/hal-00708792>**

Submitted on 20 Jun 2012

**HAL** is a multi-disciplinary open access archive for the deposit and dissemination of scientific research documents, whether they are published or not. The documents may come from teaching and research institutions in France or abroad, or from public or private research centers.

L'archive ouverte pluridisciplinaire **HAL**, est destinée au dépôt et à la diffusion de documents scientifiques de niveau recherche, publiés ou non, émanant des établissements d'enseignement et de recherche français ou étrangers, des laboratoires publics ou privés.

# Gear Impacts And Idle Gear Noise: Experimental Study And Non Linear Dynamic Model

Jean-Luc DION <sup>a,1</sup>, Sylvie LE MOYNE <sup>b</sup>, Gaël CHEVALLIER <sup>a</sup>,  
Hamidou SEBBAH <sup>a</sup>

<sup>a</sup>*SUPMECA, 3 rue Fernand HAINAUT, F-93407 Saint OUEN, France*

<sup>b</sup>*UPMC Univ Paris 6, CNRS-UMR 7190, IJLRDA, F-75005 Paris, France*

---

## Abstract

This paper develops an experimental and numerical study of dynamic phenomena involving gear impacts with one loose gear (non engaged gear pair) inside an automotive gearbox.

A dedicated test bench was designed for this study. Signal processing tools, based on the Order Tracking Method, were specially developed in order to clarify the underlying phenomena. A Particular attention was paid to the relationship between the drive shaft excitation and the energy and nature of impacts.

A topological model of contact is being proposed, based on a geometric description of solids in contact. The contact between gear meshes is defined using a Single Degree of Freedom, non linear, elastic and dissipative model. The chosen parameters of the model are not updated from measurements, but from the knowledge of the gear topology and tolerance class.

Simulations, compared with experimental results, confirm the accuracy of the model proposed.

Both model and experiments show, for particular excitation conditions, the emergence of repeated impacts on one side of the gear mesh.

*Key words:* Idle gear noise, hertzian contact, shock, backlash, non linear vibrations, signal processing

---

1 1 List of symbols

<b>Definition</b>	<b>Variable</b>
Angular position of the main shaft	$\theta_M$
Angular position of the loose gear	$\theta_L$
<b>Definition</b>	<b>Parameters</b>
Viscous coefficient introduced by lubricant between shaft and gear	$C$
Structural damping of the L and M teeth in contact	$C_{LM}$
Angular damping of the contact	$C_\theta$
Translational damping of the contact (along $\xi$ -axis)	$C_\xi$
Momentum inertia of the loose gear	$I_{zz^{(k)}}^k(P) = I_L$
Structural elasticity of the L and M teeth in contact	$K_{LM}^*$
Angular elasticity of the contact	$K_\theta$
Translational elasticity of the contact (along $\xi$ -axis)	$K_\xi$
Radius of the loose gear	$r_L$
Radius of the main shaft	$r_M$
Geometric defaults on the tooth	$\varepsilon$
Exponent defined by the nature of the contact	$\alpha$
Backlash	$G$
Pitch diameter on the loose gear	$\xi_L$
Pitch diameter on the main shaft	$\xi_M$

4 As the demand for acoustic comfort is constantly increasing, car  
5 manufacturers are concerned by noise annoyance problems in ve-  
6 hicles, and especially by the annoyance generated by gearboxes.  
7 Among numerous gearboxes noises, idle gear noise is perceived  
8 as particularly disagreeable and often wrongly associated with  
9 an engine problem by consumers. This noise is generated by gear  
10 impacts which can appear either in driving conditions ("rattle"  
11 noise) or in neutral ("idle" noise or "neutral rattle" noise ). As  
12 neutral is the worst configuration, it is the focus of this paper.

13 The present paper presents an experimental and numerical study  
14 of the gear impact. The aim of the study is to define a simple and  
15 realistic model of contact able to describe the dynamic impacts  
16 between gears with invariant parameters for several frequencies,  
17 levels and types of excitations. To this end, the nonlinear Single  
18 Degree of Freedom (SDOF) gear pair model with backlash, which  
19 has often been investigated in the literature, has only included  
20 few parameters for the gear topology and tolerance class. The  
21 choice of the model to be developed was governed by a literature  
22 study, but also by a preliminary experimental study.

23 The test bench designed for this study is composed of an off-the-  
24 shelf simplified gear box (only one gear couple is kept). The choice  
25 of measurement and signal processing techniques was governed  
26 by the very transient character of the events being observed. This  
27 experimental part of the study particularly focuses on the deter-  
28 mination of relationships between the excitation kinematics and  
29 the nature and the energy content of the impact. Energy contents  
30 are analyzed globally and also in terms of frequency distribution.  
31 The model thus formulated endeavors to predict the dynamic  
32 behaviour of a gear box by associating a limited number of non-  
33 linear SDOF. After an analytical description of the model, para-  
34 metric identification techniques are presented.

35 The only model parameters that are identified with experimental  
36 techniques are the dissipative coefficients. All other parameters

37 of the model are determined in accordance with technical design  
38 data.

39 In the final section, before drawing our conclusions, numerical  
40 simulations and experimental measurements will be compared.

### 41 **3 Literature**

42 Most previous studies of such phenomena propose analytical mod-  
43 els for the vibroacoustic behaviour of the entire mechanical sys-  
44 tem (gears, transmission chain). In [1], R.Singh et al. retain a  
45 Lumped Model, non-linear, and find analytical solutions, derived  
46 piecewise, section after section, from a linear analysis. In this par-  
47 ticular case, the stiffness is described with functions which have  
48 non continuous derivatives. In [2], the authors improved the latter  
49 model by the introduction of friction. Moreover the authors de-  
50 rive analytical solutions based on the Harmonic Balance Method.  
51 Many investigations have been performed to define contact char-  
52 acteristics of simple or multi-mesh gear trains, taking into ac-  
53 count friction phenomena and the influence of backlash. The first  
54 experiments focused on the detection and the analysis of non-  
55 linear phenomena [3].

56 The instantaneous characteristics in the signals can be obtained  
57 from the ridges and skeletons of the Wavelet Transform [4]. Such  
58 non-linear systems can also be described with a Volterra Func-  
59 tional Series which generalise the Superposition Principle and  
60 allows Impulse Responses and Transfer Functions of various or-  
61 ders to be obtained [5]. Other Detection Methods are based on  
62 the speed variations, [6]; in this paper, the authors show that a  
63 low cost conventional tachometer is sufficient for measuring the  
64 induced speed variations due to backlash. They can also be pre-  
65 dicted via simulation. For example, T. Tjahjowidodo et al., [4],  
66 uses a detailed multibody simulation to develop and test the ef-  
67 fectiveness of the proposed detection approach.

68 The idle gear noise is chaotic [7]. The chaotic behaviour gets  
69 stronger with increasing backlash, see [8]. In [9], T. Tjahjowidodo

70 et al., quantify the chaotic responses and correlate them to the  
71 parameters of the non-linear system, in particular the magnitude  
72 of the backlash.

73 A.Al-shyyab et al. ([10] and M. Ajmi et al. [11]) proposed models  
74 to introduce non-linearity in the contact elasticity. They also take  
75 into account the structural elasticity of gears. M. Ajmi et al. [10]  
76 considers a continuous non-linear model concentrated on contact  
77 lines in gears with a Finite Element global description. A.Al-  
78 shyyab et al. [11] chose Lumped Models, non-linear with analyt-  
79 ical solutions derived from decompositions in frequency domain.  
80 In a similar manner, J.P.Raclot et al. [12] built a combination  
81 of flexible bodies in contact with Spectral Methods for a wide  
82 excitation spectrum.

83 Various experimental studies, see for example ([13]), involve source  
84 location techniques by means of multiple Impulse Response Func-  
85 tions to detect sources of gearbox rattle using correlation between  
86 several excitations and several IRFs.

87 Other studies, of the complete gear box were performed taking  
88 into account the influence of manufacturing error on the rattle  
89 noise (see for example [14]). The degree of noise variability is  
90 assumed to be only induced by tolerances of geometric descrip-  
91 tions of gears. Mechanical models of solids are combined with  
92 acoustic models in a global statistical study. In The influence of  
93 the harmonic content of engine acyclism is analysed. As this is  
94 a main source of gear schoks, this work attempts to complement  
95 the work carried out by [15].

96 Models, such as the N.Barabanov et al. model [16], using Finite  
97 Element Methods are frequently employed for specific excitation  
98 sources: [17] introduces mechanical models for solids periodically  
99 excited by a static transmission error and incorporates acoustic  
100 models in the finite element method. Likewise, [18] conducted a  
101 study with several manufacturing errors (tooth spacing - pitch,  
102 eccentricities, misaligned gears ) and variation in excitations us-  
103 ing the model described in [10].

104 The vibroacoustic behaviour of the gear box is generally assumed  
105 to be linear and described by transfer functions following propa-

106 gation paths for solid transmission of vibration and vibroacoustic  
107 coupling with fluid propagation (atmosphere) for acoustic trans-  
108 mission ([19] [17]).

109 The only mechanical elements which cannot be described by lin-  
110 ear models are bearings ([20], [21], [22], [23]) and gears in contact.

## 111 4 Test Bench

### 112 4.1 Gear Box

113 The test bench must show impacts induced by backlash between  
114 two gears. Thus, all other sources of uncontrolled vibrations have  
115 to be suppressed.

116 The solution adopted was to obtain an off-the-shelf gearbox and  
117 modify it in order to keep only one gear couple (4<sup>th</sup> gear). As  
118 a result of the gaps due to the removal of gears and the entire  
119 command system, crossbars were added.

120 Principal gear data are the following:

121

- 122 ● 4<sup>th</sup> helical gear on the main shaft:
  - 123 · pitch diameter: 57 mm
  - 124 · number of teeth: 28
  - 125 · face width: 20 mm
  - 126 · helix angle: 30°
- 127 ● 4<sup>th</sup> loose helical gear:
  - 128 · pitch diameter: 74 mm
  - 129 · number of teeth: 37
  - 130 · face width: 20 mm
  - 131 · helix angle: 30°
- 132 ● Contact ratio: 2.9
- 133 ● individual pitch error : between 3  $\mu m$  and 15  $\mu m$

## 134 4.2 Excitation System

135 The translational oscillations of an electrodynamic shaker rod  
136 are transformed into angular oscillations of the main shaft through  
137 two perpendicular transmission beams (Fig .1 and Fig .2). The  
138 motion obtained is pure angular oscillations with an average an-  
139 gular speed equal to zero. The authors chose to carry out the  
140 experiment in this way in order to reproduce a gearbox in neu-  
141 tral. Transmission beam dimensions were calculated in order to  
142 respect the following conditions:

- 143 • The circular trajectory of the joint between the two transmis-  
144 sion beams (point A) should not damage the shaker.
- 145 • The eigen frequencies of the excitation system should not per-  
146 turb measurements.

147 The rigid transmission beam, between the flexible beam and the  
148 axe of the main shaft, is 165 mm long.

149 The excitation reproduces actual engine torque oscillations which  
150 are sources of the noise and vibration under study: sinusoidal ex-  
151 citation from 30 Hz to 60 Hz with a maximal oscillation magni-  
152 tude of 2000 rad/s<sup>2</sup>.

## 153 4.3 Measurement Setup

154 The excitation is controlled by a piezoelectric accelerometer fixed  
155 on the output of the shaker. In order to verify the non distortion  
156 of the signal transmitted to the main shaft of the gearbox, a sec-  
157 ond accelerometer is fixed at the end of the main shaft.

158 A rigid support is inserted in the loose gear under study, at 46  
159 mm from the axe. This support is used for the fixation of a piezo-  
160 electric accelerometer.

161 A hole was made in the gearbox house for accessibility and fixa-  
162 tion of sensors (Fig .3 and Fig .4). The natural eigen frequency  
163 of the support was calculated greater than 3200 Hz.



## 164 5 Experimental Study

### 165 5.1 Signal Processing And Analysis Method

166 The present method uses only instantaneous signals in both time  
167 and frequency domains, and thus banishes averaging techniques.  
168 Indeed, preliminary studies involving average signal in time do-  
169 main, in order to eliminate the random part of the signals and  
170 retain the deterministic part, led to significant signal leakage and  
171 more particularly to an underestimation of the frequency content  
172 of the signals.

173 After conducting a major experimental study, it was possible to  
174 determine the most efficient signal processing representations for  
175 those particular phenomena, in both time and frequency domains:

- 176 ● Instantaneous temporal signals
- 177 ● Periodgrams representing the magnitude of the loose gear ac-  
178 celeration, according to the period  $N = t.F_{ex}$  where  $t$  is time  
179 and  $F_{ex}$  the excitation frequency
- 180 ● Three dimensional spectral representations of loose gear ac-  
181 celeration magnitude versus frequency (or tracking order) and  
182 excitation frequency.

183 Measures are converted from translation motion to angular mo-  
184 tion in order to respect the kinematical properties of the system  
185 (Fig .3).

186 The system is excited by a sine wave with a variable frequency,  
187 the observed responses are then periodic but not harmonic. Ex-  
188 perimental results are thus to be normalized to the excitation  
189 frequency. A re-sampling technique based on FIR filter algorithm  
190 is implemented to avoid signal distorsion.

192 One can first observe instantaneous time signals (Fig .5). Differ-  
 193 ent types of behaviour appear, depending of the excitation level:

- 194 ● for low excitation levels, no impact appears between the teeth  
 195 of the gears,
- 196 ● as the excitation increases, an impact occurs only on one side  
 197 (F+) of the tooth. After the impact, the behaviour of the tooth  
 198 leads to free vibrations (Fig .5c),
- 199 ● for greater excitation, impacts occur on both sides of the tooth  
 200 (F+ and F-). The impact level on F+ is greater and free vi-  
 201 brations are observed only for this impact (Fig .5d),
- 202 ● when the level of excitation increases, two impacts are observ-  
 203 able in a very short time (less than 1ms): two pairs of teeth  
 204 are in contact at the same time (Fig .5h),
- 205 ● for the greatest excitation the impact on F- becomes stronger  
 206 than the one on F+ (Fig .5g).

207 Those behaviours and their evolution were observed in the entire  
 208 range of the excitation frequency ([30 Hz 60 Hz]).

209 It is particularly interesting to observe that impacts appear sev-  
 210 eral times on the same side F+ before changing the side F-. In-  
 211 deed, the first impact is not strong enough to push the tooth up  
 212 to the other side. Two or three impacts then occur before chang-  
 213 ing the side of impact. This phenomenon appears more clearly  
 214 on periodgrams (Fig .6).

215 Acceleration signals of the loose gear show areas with a constant  
 216 acceleration near zero (Fig .7 right). For these short sections, the  
 217 velocity decreases slowly (Fig .7 left): the loose gear is in free  
 218 motion with a small damping. During those sections of "free mo-  
 219 tion", the decay of the velocity is proportional to the velocity:  
 220 this energy dissipation can then be described with a classical vis-  
 221 cous damping as an angular dashpot. This behaviour is due to  
 222 the lubricant between the second shaft and the loose gear.

223 The analysis of the relative displacement on the pitch diameter

224 allows one to estimate the backlash between gears. When the  
225 level of excitation increases, this free motion gap presents an ap-  
226 parent increase (from  $40 \mu m$  to  $80 \mu m$ ): in fact, for the highest  
227 level, some parts of the mechanism can not be assumed to be  
228 rigid bodies, flexible behaviour has to be introduced. For exam-  
229 ple, a 1000 N force on the driving arm induces a deformation of  
230  $10 \mu m$ . The actual backlash is in fact  $80 \mu m$ .

### 231 5.3 Frequency Analysis

232 Spectral analysis is represented in the frequency domain or with  
233 the Tracking Order Method. The three dimensional representa-  
234 tions in Fig .8 show the evolution of the spectral signature of  
235 the teeth impacts in accordance with the excitation level for two  
236 excitation frequencies: 30 Hz and 60 Hz. For both frequencies  
237 a threshold of excitation shows a break-even point from which  
238 the impact spectrum extended strongly from 500 Hz to more  
239 than 5000 Hz. In all the experiments, the signal level strongly  
240 decreases around 3200 Hz: this is due to the sensor support plate  
241 on which measurements are performed, which plays the rule of  
242 dynamic absorber tuned at 3200Hz (Fig .8).

### 243 5.4 Parametric Analysis

244 With the aim of showing the influence of acceleration, velocity  
245 and displacement levels, three classes of experiments have been  
246 conducted with the excitation frequency between 30 Hz and 60  
247 Hz:

- 248 ● at a constant displacement magnitude,
- 249 ● at a constant velocity magnitude,
- 250 ● at a constant acceleration magnitude,

251 The excitation is controlled thanks to an accelerometer placed on  
252 the electrodynamics shaker head.

253 These experiments were performed with several levels of excita-  
254 tion.

255 The figure .5 represents periodgrams according to the excitation  
256 frequency for each of the three classes of measurements.

257 Periodgrams with a constant magnitude of the excitation accel-  
258 eration is the most invariant with excitation frequency (in term  
259 of energetic level of impacts). According to a simple linear ap-  
260 proach, forces can be described in terms of acceleration. So the  
261 acceleration of the loose gear depends on the impact force and  
262 consequently on the excitation level of the main shaft.

263 The number of impacts on a given side strongly depends on the  
264 displacement level induced by the angular oscillations of the main  
265 shaft: for a given main shaft displacement magnitude, the ener-  
266 getic level of impacts increases with the excitation frequency, but  
267 the number of impacts keep the same.

## 268 **6 Model**

### 269 *6.1 Global Description*

270 The model proposed in the present paper is based on a non linear  
271 Single angular Degree Of Freedom (Fig .8) which can relate the  
272 main shaft behaviour to the loose gear in terms of force, torque,  
273 acceleration, speed and position in translation and rotation.

274 The non linear approach is obvious: for an excitation composed  
275 of a single frequency, the dynamic response can be broken down  
276 into several frequencies over ten times the excitation frequency.

277 The very first excitation is introduced by the behaviour of the  
278 main shaft. The neutral gear dynamic rattle appears with im-  
279 pacts between loose gears and the main shaft. The only possible  
280 transmission path for vibrations is the shaft, which is supposed to  
281 have a linear behaviour. Moreover, the main non linear behaviour  
282 is concentrated between the main shaft and the loose gear.

283

284 For this paper several models were considered in order to pro-

285 pose the most appropriate one for the study. The very first tested  
286 models are lumped models described by [15] and [10]. These mod-  
287 els are made with specific non linearity of elasticity and damping  
288 with the objective to performing analytical solutions section af-  
289 ter section. The dynamic description of the contact and impacts  
290 is performed as a succession of sections (based on periodic solu-  
291 tions). In such models, the dynamic response between two tem-  
292 poral sections (large and discontinuous evolution of the stiffness  
293 for example) does not take into account the gradual evolution  
294 of the stiffness between the two states. Although, several studies  
295 ([24], [25]) had established that the dynamic response of solids in  
296 contact depends strongly on the progression of the stiffness func-  
297 tion and more precisely on the geometric defaults (shape and  
298 micro geometry in terms of roughness). Simulations performed  
299 with these models overestimate the number and the levels of im-  
300 pacts and underestimate the duration of each impact (still using  
301 parametric identification obtained by updating the models with  
302 measurements). For these reasons this kind of Lumped Model  
303 was abandoned.

304 Other tested techniques ([13]) consist in building the solution  
305 in the frequency domain with a semi analytic method. This ap-  
306 proach needs a specific analytical description of elasticity and  
307 damping (such as polynomial decomposition) and a large num-  
308 ber of terms if realistic simulations are required. More over, this  
309 method could not describe an important phenomenon experimen-  
310 tally observed: several impacts occur on the same side of a tooth  
311 before changing sides. For these reasons this kind of method was  
312 not retained either.

313 Models based on Finite Element Method ([26]) are very heavy  
314 models in terms of computing time and memory. Moreover, it  
315 remains difficult to describe the complete geometry with specific  
316 defaults as roughness, which are important parameters in the  
317 dynamic of the shocks. However, this technique could be success-  
318 fully used with the aim of identifying the structural stiffness of  
319 solids. For dynamic excitations this kind of model could not be  
320 used with reasonable computation time except for specific kinds

321 of excitation ([26]). In the present study, the roughness had to  
 322 be taken into account and the excitation is not supposed to be  
 323 known. This is the reason why this method has not been devel-  
 324 oped in this paper.

325 The proposed Lumped Model can be considered as a prolongation  
 326 of classical Single Degree Of Freedom with non linear stiffness and  
 327 damping. Models of stiffness and damping were chosen with the  
 328 aim of taking into account the backlash, the geometric default of  
 329 tooth (roughness) and the nature of the contact.

330 The elementary model for rotation on the z axis is defined by:

$$331 \quad I_L \ddot{\theta}_L + K_\theta(\theta_M, \theta_L) + C_\theta(\dot{\theta}_M, \dot{\theta}_L, \theta_M, \theta_L) + C\dot{\theta}_L = B \quad (1)$$

332 with:

- 333 •  $B$  : external torque
- 334 •  $C$  : viscous coefficient for dissipative behaviour introduced by  
 335 lubricant between the loose gear and the shaft.

336 The transmission error  $\xi$  on the curvilinear axis for translation  
 337 displacement (on pitch diameters) is defined by:

$$338 \quad \xi = \xi_L - \xi_M = r_L \theta_L - r_M \theta_M \quad (2)$$

339 where  $r_L$  and  $r_M$  are respectively the pitch radius of the loose  
 340 gear and the main gear.

341 Impacts are conditioned by  $\xi$  along the pitch diameter, although  
 342 the nonlinear dynamic equation for the elementary model is writ-  
 343 ten for the angular variable.

344  $K_\theta(\theta_M, \theta_L)$  the angular elasticity of the contact and  $C_\theta(\theta_M, \theta_L, \dot{\theta}_M, \dot{\theta}_L)$   
 345 the angular dissipation of the contact are simply and respectively  
 346 linked to  $K_\xi(\theta_M, \theta_L)$  and  $C_\xi(\theta_M, \theta_L, \dot{\theta}_M, \dot{\theta}_L)$  the same function  
 347 projected on the axis :

$$348 \quad K_\theta(\theta_M, \theta_L) = r_L K_\xi(\xi_M, \xi_L) \quad (3)$$

$$349 \quad C_\theta(\theta_M, \theta_L, \dot{\theta}_M, \dot{\theta}_L) = r_L C_\xi(\xi_M, \xi_L, \dot{\xi}_M, \dot{\xi}_L) \quad (4)$$

351 Five different cases are considered, depending on transmission er-  
 352 ror value compared to geometric manufacturing errors and back-  
 353 lash (see figure .11).

354 The explicit expression of the contact elasticity  $K_\xi(\xi_M, \xi_L)$  is:

- 355 • when the gears are in contact on side F+ :  $\forall \xi \leq -\varepsilon$

$$356 \quad K_\xi = K_{LM}^* (\xi_L - \xi_M) \left| \frac{\xi_L - \xi_M}{G} \right|^{\alpha-1} \quad (5)$$

- 357 • when the gears are near the contact on side F+ :  $\forall -\varepsilon \leq \xi \leq 0$

$$358 \quad K_\xi = \frac{K_{LM}^*}{2} \left( 1 - \left( \frac{\varepsilon}{2} + \xi_L - \xi_M \right) \sin \left( \frac{\pi}{\varepsilon} \right) \right) \left( \xi_L - \xi_M \right) \left| \frac{\xi_L - \xi_M}{G} \right|^{\alpha-1} \quad (6)$$

- 359 • when the gears are separated :  $\forall 0 \leq \xi \leq G$

$$360 \quad K_\xi = 0 \quad (7)$$

- 361 • when the gears are near the contact on side F- :  $\forall G \leq \xi \leq G + \varepsilon$

$$362 \quad K_\xi = \frac{K_{LM}^*}{2} \left( 1 - \left( \frac{\varepsilon}{2} - (\xi_L - \xi_M - G) \right) \sin \left( \frac{\pi}{\varepsilon} \right) \right) \left( \xi_L - \xi_M - G \right) \left| \frac{\xi_L - \xi_M}{G} - 1 \right|^{\alpha-1} \quad (8)$$

- 363 • when the gears are in contact on side F- :  $\forall G + \varepsilon \leq \xi$

$$364 \quad K_\xi = K_{LM}^* (\xi_L - \xi_M - G) \left| \frac{\xi_L - \xi_M}{G} - 1 \right|^{\alpha-1} \quad (9)$$

365 with :

- 366 •  $K_{LM}^*$  the equivalent static stiffness of contact between the teeth  
 367 L and M ([24])
- 368 •  $\alpha$  the contact-type coefficient (e.g. sphere to plane, cylinder to  
 369 cylinder ) ([27])(see figure .10
- 370 •  $\varepsilon$  the size of manufacturing errors on the tooth ( e.g. shape  
 371 defects and micro-geometric defaults) ([25])

372 •  $G$  the backlash ([28]) on the pitch diameter.

373 The equation (6 and 8) ensure the continuity of the function  $K_\xi$   
374 and its first derivatives.

375 The dissipative coefficient of the contact is defined with the same  
376 existing conditions as for the elasticity function.

377 This kind of normal contact model is used in several applications:  
378 for particular applications such as the dynamic behaviour of the  
379 compressor valve contacts or non lubricated gears, a friction dis-  
380 sipative term in the dissipative function had to be introduced  
381 ([29]).

382 The explicit expression for the dissipative coefficient  $C_\xi(\xi_M, \xi_L, \dot{\xi}_L, \dot{\xi}_M)$   
383 is:

384 •  $\xi \leq -\varepsilon$

385  $C_\xi = C_{LM}(\dot{\xi}_L - \dot{\xi}_M)$

386 •  $-\varepsilon \leq \xi \leq 0$

387  $C_\xi = \frac{C_{LM}}{2} \left(1 - \left(\frac{\varepsilon}{2} + \xi_L - \xi_M\right) \sin\left(\frac{\pi}{\varepsilon}\right)\right) (\dot{\xi}_L - \dot{\xi}_M)$

388 •  $0 \leq \xi \leq G$

389  $C_\xi = 0$

390 •  $G \leq \xi \leq G + \varepsilon$

391  $C_\xi = \frac{C_{LM}}{2} \left(1 - \left(\frac{\varepsilon}{2} - (\xi_L - \xi_M - G)\right) \sin\left(\frac{\pi}{\varepsilon}\right)\right) (\dot{\xi}_L - \dot{\xi}_M)$

392 •  $G + \varepsilon \leq \xi$

393  $C_\xi = C_{LM}(\dot{\xi}_L - \dot{\xi}_M)$

394 Where  $C_{LM}$  denotes the associated damping of contact between  
395 the teeth  $L$  and  $M$  ([29])

## 396 7 Model Characterization

### 397 7.1 Aims And Methods

398 The aim of the proposed model is to simulate the source of dy-  
399 namic excitation in gear boxes.

400 The model proposed in the present paper is deterministic and  
401 preserves stationary properties. Each parameter is invariant and



402 independent of the excitation level and the frequency.  
 403 All parameters, except for dissipative behaviour, were identified  
 404 without dynamic measurements. Most of them had been pro-  
 405 duced by Renault SA. Some of them, such as  $K_{LM}^*$ ,  $K_\theta$  and  $\alpha$  were  
 406 determined by using classical engineering gears methods ([28]).  
 407 The choice of the model and its parameters had been strongly  
 408 influenced by the possibility to identify the parameters with a  
 409 greater degree of accuracy.  
 410 Each parameter is determined by a simple analytic model based  
 411 on the design of gear. But they can also be identified by a single  
 412 dynamic measure on the studied test bench excited with har-  
 413 monic signal.  
 414 For each degree of freedom, 9 parameters had to be identified for  
 415 the model:

- 416 • geometric parameters:  $I_L, r_L, r_M$
- 417 • elastic parameters:  $K_{LM}, \alpha, \epsilon, G$
- 418 • dissipative parameters:  $C_{LM}, C$

419 These parameters are presented and explained in greater detail  
 420 in paragraphs 7.2 to 7.4. Numerical values for each parameter  
 421 are given in the case of the studied gear box. Corresponding sim-  
 422 ulations are presented in paragraph 8, and compared with the  
 423 experiments.

## 424 7.2 Geometric parameters

- 425 •  $I_L$  : Moment of Inertia for the loose gear. Normally, this pa-  
 426 rameter is obtained numerically from the geometrical model  
 427 and the density of the material. ( $I_L=0.32(10^{-3})$  kg.m<sup>2</sup>)
- 428 •  $r_L$  and  $r_M$  : are respectively the pitch radius of the loose gear  
 429 and the main gear ( $r_L=37$  mm and  $r_M=28.25$  mm)

## 430 7.3 Elasticity

- 431 •  $K_{LM}$  : the equivalent elasticity between the  $L$  and  $M$  teeth  
 432 in contact. This can be obtained by a numerical identification

433 with a Finite Element study of teeth in contact or more easily  
 434 by the retained method defined by Palmgren ([24]). To avoid  
 435 coupling with  $\alpha$  and  $G$  parameters and unit incompatibility, the  
 436 parametric identification is performed on  $K_{LM}^* = K_{LM} \cdot G^{(\alpha-1)}$ .  
 437 This method reveals a non-dimensional variable  $\xi^* = \xi/G$   
 438 and independent parameters  $K_{LM}^*$ ,  $\alpha$ ,  $G$ . ( $K_{LM}^* = 3(10^6)$  N.m<sup>-1</sup>;  
 439  $K_{LM} = 1.03 \cdot (10^8)$  N.m<sup>-4/3</sup>).

- 440 ●  $\alpha$  : This coefficient is defined according to the type of contact  
 441 ([27]): a simple line contact leads to  $\alpha = 10/9$ , a single point  
 442 leads to  $\alpha = 3/2$ . In fact, for spur or helical gears the actual con-  
 443 tact is neither linear nor punctual. This parameter had then  
 444 to be identified between these two cases and was used to min-  
 445 imize the discrepancy between experimental measures and nu-  
 446 merical simulations (Fig .10). ( $\alpha = 4/3$ ). Generally speaking gear  
 447 manufacturing requires that gear teeth are shaped to ensure a  
 448 contact area limited to the central part of the tooth [28].
- 449 ●  $\epsilon$  : the size of manufacturing errors on the teeth (shape defects  
 450 and micro-manufacturing errors) ([25]). This parameter trans-  
 451 forms the point discontinuity into a continuous curve over an  
 452 infinitesimal displacement interval thus the instantaneous stiff-  
 453 ness increases from 0 to the equivalent solid stiffness  $K_{LM}$  over  
 454 the deformation interval  $\epsilon$  of manufacturing errors ( $\epsilon = 1 \cdot 10^{-6}$   
 455 m).
- 456 ●  $G$  : the backlash ([28]) on the pitch perimeter (projected onto  
 457 the  $\xi$  axis). This parameter is the main cause of idle gear noise.  
 458 As this parameter is well known and statistically verified during  
 459 the manufacturing process it cannot be excluded from consid-  
 460 eration for technological reasons such as assembly or operating  
 461 constraints. ( $G = 0.025$  mm)

462 The complete elastic function is defined by 6 parameters ( $r_L$ ,  $r_M$ ,  
 463  $K_{LM}$ ,  $\alpha$ ,  $\epsilon$ ,  $G$ ) and 2 variables  $\xi_L$  and  $\xi_M$ .  
 464  $K_\xi(\theta_M, \theta_L)$  is exhaustively defined by 4 parameters ( $K_{LM}$ ,  $\alpha$ ,  $\epsilon$ ,  
 465  $G$ ). (Fig .11)

467  $C_{LM}$  is the associated damping of the  $L$  and  $M$  teeth in contact  
 468 ([24]). To avoid coupling with  $K_{LM}$ ,  $I_L$ ,  $\alpha$ ,  $G$  and  $r_L$  parameters,  
 469 the parametric identification is obtained from:

$$470 \quad C_{LM}^* = \frac{C_{LM}}{2\sqrt{K_{LM}^* \frac{I_L}{r_L^2}}} \quad (10)$$

471 This method reveals a non-dimensional and independent param-  
 472 eter  $C_{LM}^*$ . This parameter cannot easily be predicted before ex-  
 473 perimentation but it can be accepted as being in the band from  
 474 1 to 5 percent.

475 For several industrial applications this dissipative model can be  
 476 added or replaced by a friction model with an internal state vari-  
 477 able ([30], [31], [16]). ( $C_{LM}^*=0.04$  ;  $C_{LM}=67 \text{ N.s.m}^{-1}$ ).

478 The model described in [30] was successfully tested but not re-  
 479 tained in the final presented model in order to preserve the sim-  
 480 plicity of the global model. More over, the accuracy needed for  
 481 the dissipation function in this study does not justify the intro-  
 482 duction of new parameters.

483 The complete dissipative function is defined by 5 parameters ( $r_L$ ,  
 484  $r_M$ ,  $C_{LM}$ ,  $\epsilon$ ,  $G$ ) and 4 variables  $\xi_L$ ,  $\xi_M$ ,  $\dot{\xi}_L$  and  $\dot{\xi}_M$ .

485  $C_\xi(\theta_M, \theta_L, \dot{\theta}_M, \dot{\theta}_L)$  is completely defined by 3 parameters ( $C_{LM}$ ,  
 486  $\epsilon$ ,  $G$ ) and produces a dissipative force proportional to the velocity  
 487 of the impact.

488  $C$  is the viscous coefficient for dissipative behaviour introduced  
 489 by a lubricant between the loose gear and the shaft. This coeffi-  
 490 cient can be identified with an analytic fluid model between two  
 491 infinite cylinders or with a simple measure of velocity when the  
 492 loose gear is in free rotation (Fig .13).

493 With the intention of constructing independent parameters and  
 494 to avoid coupling with  $I_L$  parameter, the parametric identifica-  
 495 tion is led on  $C^* = C/I_L$  This method reveals an independent  
 496 parameter  $C^*$  and the time response for an initial velocity  $S_0$  at

497  $t_0$  is:

$$498 \quad S(t) = S_0 e^{-C^*(t-t_0)} = S_0 e^{-\frac{C}{I_L}(t-t_0)} \quad (11)$$

499  $S(t)$  corresponds to computed dash-dot lines in red on Fig. .9  
500 ( $C^*=78 \text{ s}^{-1}$  ;  $C=0.025 \text{ N.s.m}$ ). When these dash-dot lines are  
501 compared with free motion episodes of the loose gear, they rep-  
502 resent a good method to estimate the quality of the numerical  
503 identification of  $C$ .

## 504 8 Numerical and Experimental Comparison

505 All simulations shown were performed with numerical values de-  
506 fined in section 7 for each parameter of the model built.

507 In an effort to improve the graphic legibility and kinematical  
508 analysis, measured and simulated signals are studied between 0  
509 Hz and 1000 Hz using classical filtering techniques ( $10^{th}$  order  
510 Cauer filter with phase compensations).

511 Three comparisons between the numerical simulations and the  
512 experimental measures are shown. Each comparison is defined by  
513 the excitation level of the main shaft and its frequency:

- 514 ● 30 Hz, 300 Rad.s<sup>-2</sup> RMS (12 m.s<sup>-2</sup> amplitude peak on the  
515 pitch diameter of the main gear)
- 516 ● 60 Hz, 300 Rad.s<sup>-2</sup> RMS (12 m.s<sup>-2</sup> amplitude peak on the  
517 pitch diameter of the main gear)
- 518 ● 30 Hz, 500 Rad.s<sup>-2</sup> RMS (20 m.s<sup>-2</sup> amplitude peak on the  
519 pitch diameter of the main gear)

520 Other comparisons were made for frequencies between 30 Hz and  
521 60 Hz (by 2 Hz steps) and for several angular accelerations from  
522 100 Rad.s<sup>-2</sup> RMS to 700 Rad.s<sup>-2</sup> . The presented comparisons  
523 cover a large field of significant cases with a high level of idle gear  
524 noise.

525 For each comparison, different kinds of kinematic results are  
526 shown:

- 527 ● acceleration on the pitch diameter of the loose gear
- 528 ● velocity on the pitch diameter of the loose gear
- 529 ● displacement on the pitch diameter of the loose gear
- 530 ● transmission error in displacement between the main and loose
- 531 gears.

### 532 *8.1 Initial Comparison: The Lower Limit Frequency Of Idle Gear Noise*

533 The first comparison is undertaken at an excitation frequency  
534 of 30 Hz and an acceleration of 300 Rad.s<sup>-2</sup> RMS (12 m.s<sup>-2</sup>  
535 amplitude peak on the pitch diameter of the main gear)

536 The comparison based on angular position or displacement along  
537 the pitch diameter ( $\xi$  axis) (Fig .12) shows a very strong correla-  
538 tion between experimental measurements and numerical simula-  
539 tions. Often in cases of dynamic systems, observations involving  
540 this kind of kinematic variable display a close fit between mea-  
541 surements and models. The comparison of kinematic variables  
542 had to be conducted with greater order derivatives to confirm  
543 the models.

544 The simulated velocity describes with precision levels and events  
545 during the dynamic simulation: synchronization of the different  
546 steps during the excitation, shocks and free motions, are pre-  
547 dicted with strong accuracy (Fig .10).

548 Acceleration is the more convenient kinematic descriptor for im-  
549 pact identification and vibroacoustic prediction of complete struc-  
550 tures. Acceleration levels and the number of impacts are accu-  
551 rately predicted. Simulated peaks decrease in accordance with  
552 measurements (Fig .11).

553 Another way to identify impacts and dynamic behaviour of gears  
554 is to represent the relative displacement between the main gear  
555 and the loose gear. This displacement results from the backlash  
556 between teeth shown by the gap between the two horizontal dash-  
557 dotted lines on Fig .17, .19, .22.

558 *8.2 Second Comparison: The Upper Limit Frequency Of Idle Gear Noise*

559 The second comparison is performed at a frequency of 60 Hz and  
560 an acceleration of  $300 \text{ Rad.s}^{-2}$  RMS ( $12 \text{ m.s}^{-2}$  amplitude peak  
561 on the pitch perimeter of the main gear).

562 The model's parameters are numerically the same as those used  
563 for the previous comparison and those identified in section 7.

564 The evolution of the frequency from 30 Hz to 60 Hz reduces the  
565 number of shocks from 4 or 5 to only 2 or 3 shocks each time on  
566 the same side. The level of acceleration does not change signifi-  
567 cantly as the frequency increases (Fig .13).

568 Transmission error clearly shows only two shocks on the same side  
569 of the tooth before changing sides (Fig .14). When the frequency  
570 increases the number of shocks on the same side is reduced and  
571 the length of free motion phases of the loose gear significantly  
572 shortens.

573 Velocity (Fig .15) is also correctly predicted in terms of magni-  
574 tude and events by the numerical simulation.

575 *8.3 Third Comparison: Effect of an excitation level increase*

576 The third comparison is performed at a frequency of 30 Hz and  
577 an acceleration of  $500 \text{ Rad/s}^2$  RMS ( $20 \text{ m.s}^{-2}$  amplitude peak on  
578 the pitch perimeter of the main gear).

579 The model's parameters are numerically the same as those used  
580 for the previous comparisons and those identified in section 7.

581 When the excitation magnitude increases, the number of shocks  
582 increases as does their acceleration magnitude (Fig .16).

583 Shock period and number can also be predicted from the trans-  
584 mission error diagram (Fig. .17). Shocks seem to happen over  
585 the interval  $G$  between teeth (red dash-dotted lines). In fact, this  
586 effect is due to the coupling between dynamic behaviour of the  
587 loose gear and the non linear stiffness of its teeth (progression  
588 depending on manufacturing errors  $\epsilon$ ).

589 When the excitation magnitude increases, the model maintains a

590 high level prediction for kinematic behaviour in terms of velocity  
591 (Fig .18).

592 Another way to identify and quantify shocks is obtained in post  
593 processing velocities with the intention of measuring the relative  
594 velocity when shocks occur (Fig .19). This graph reinforces the  
595 analysis of shocks and can also permit one to quantify the ve-  
596 locity of each shock and thus, the kinematical energy of shocks  
597 and its evolutions in Rayleigh (dissipative) and potential (elastic)  
598 Energy.

## 599 9 Conclusion

- 600 ● The experimental study outlines phenomena and parameters  
601 responsible for the idle gear noise.
- 602 ● The model built is a non linear Single Degree Of Freedom in  
603 rotation composed of 9 independent and invariant parameters:  
604 The identification of each parameter can be performed with  
605 an analytical and numerical approach or by measurements on  
606 a single dynamic test. To find the independence of each pa-  
607 rameter and for a better accuracy, identifications presented in  
608 section 7 are performed with reduced variables and parameters.  
609 In several cases these reduced parameters are dimensionless.
- 610 ● All simulations were carried out with the same set of param-  
611 eters and reveal a very close fit with experimental measure-  
612 ments. The kinematic of the impacts is well predictable in  
613 terms of magnitude, duration, for number of one-sided impacts  
614 as well as the decrease in the magnitude of each impacts.
- 615 ● Both simulations and experimental measurements reveal the  
616 following important points:
  - 617 · several impacts can often appear on one side of the gear mesh,
  - 618 · the number of impacts on one side strongly depends on the  
619 angular displacement of the main shaft,
  - 620 · the energy level of impacts mainly depends on the accelera-  
621 tion level of the main shaft oscillations,
- 622 ● The excitation level at which impacts appear is identified, pre-  
623 dicted and closely connected with the acoustic phenomenon  
624 called idle gear noise.
- 625 ● The next step of this study is to undertake a vibroacoustic  
626 model of the gear box based on this study of a single couple of  
627 gears. The aim of this work is to show the predictable vibroa-  
628 coustic behaviour of a complete gear box with a small number  
629 of (non linear) Degrees of Freedom.

## 630 Acknowledgment

631 The authors express their gratitude to Renault SA for the finan-  
632 cial support of this study.



633 **References**

- 634 [1] R.J.Comparin R.Singh, H.Xie. Analysis of automotive neu-  
635 tral gear rattle. *Journal of Sound and Vibration*, 131:177–  
636 196, 1989.
- 637 [2] P.Velex P.Sainsot. An analytical study of tooth friction ex-  
638 citations in errorless spur and helical gears. *Mechanism and*  
639 *machine theory*, 37:641–658, 1996.
- 640 [3] M.-C. Pan H. Van Brussel P. Sas. Intelligent joint fault di-  
641 agnosis of industrial robots. *Mechanical Systems and Signal*  
642 *Processing*, 12(4):571–588, 1998.
- 643 [4] T. Tjahjowidodo F. Al-Bender H. Van Brussel. Experimen-  
644 tal dynamic identification of backlash using skeleton meth-  
645 ods. *Mechanical Systems and Signal Processing*, 21:959–972,  
646 2007.
- 647 [5] I. Tawfiq T. Vinh. Contribution to the extension of modal  
648 analysis to non-linear structure using volterra functional se-  
649 ries. *Mechanical Systems and Signal Processing*, 17(2):379–  
650 407, 2003.
- 651 [6] Jeffrey L. Stein Churn-Hway Wang. Automatic detection of  
652 clearance in mechanical systems: Experimental validation.  
653 *Mechanical Systems and Signal Processing*, 10(4):395–412,  
654 1996.
- 655 [7] R.M. Lin D.J. Ewins. Chaotic vibration of mechanical sys-  
656 tems with backlash. *Mechanical Systems and Signal Pro-*  
657 *cessing*, 7(3):257–272, 1993.
- 658 [8] I. Trendafilova H. Van Brussel. Non-linear dynamics tools for  
659 the motion analysis and condition monitoring of robot joints.  
660 *Mechanical Systems and Signal Processing*, 15(6):1141–1164,  
661 2001.
- 662 [9] T. Tjahjowidodo F. Al-Bender H. Van Brussel. Quantifying  
663 chaotic responses of mechanical systems with backlash com-  
664 ponent. *Mechanical Systems and Signal Processing*, 21:973–  
665 993, 2007.
- 666 [10] M. Ajmi P.Velex. model for simulating the quasi-static and  
667 dynamic behaviour of solid wide-faced spur and helical gears.

- 668 *Mechanism and Machine Theory*, 40:173–190, 2005.
- 669 [11] A.Al shyyab A.Kahraman. Non-linear dynamic analysis of  
670 multi-mesh gear train using multi-term harmonic balance  
671 method: sub-harmonic motions. *Journal of Sound and Vi-*  
672 *bration*, 279:417–451, 2005.
- 673 [12] J.P.Raclot P.Velex. Simulation of dynamic behaviour of sin-  
674 gular and multi-stage geared systems with shape deviations  
675 and mounting errors by using a spectral method. *Journal of*  
676 *Sound and Vibration*, 220(5):861–903, 1999.
- 677 [13] J.Blomqvist W.Kropp. Detection of rattle sources in gearbox  
678 using correlation technique. *acta acustica*, 87:77–85, 2001.
- 679 [14] N.Driot E.Rigaud J.Sabot. Allocation of gear tolerances to  
680 minimize gearbox noise variability. *acta acustica*, 87:67–76,  
681 2001.
- 682 [15] M.Barthod J.L.Tébec J.C.Pin. étude de l’influence des car-  
683 actéristiques de l’acyclisme sur le bruit de ”grailonnement”  
684 dans les boites de vitesses automobiles. In *Congrès ”Vibra-*  
685 *tions, Chocs et Bruit”*, 2002.
- 686 [16] N.Barabanov R.Ortega. A new model for control of sys-  
687 tems with friction. *IEEE Transactions on automatic control*,  
688 45(4):830–832, 2000.
- 689 [17] P.Ducret J.Sabot. Calcul du bruit rayonné par les carters  
690 des transmissions à engrenages : méthode et applications.  
691 *acustica*, 84:97–107, 1998.
- 692 [18] P.Velex M.Maatar. A mathematical model for analysing  
693 the influence of shape deviations and mounting error on  
694 gear dynamic behaviour. *Journal of Sound and Vibration*,  
695 191(5):629–660, 1996.
- 696 [19] T.C.Lim R.Singh. A review of gear housing dynamics and  
697 acoustics literature. *NASA report*, 1989.
- 698 [20] T.C.Lim R.Singh. Vibration transmission through rolling el-  
699 ement bearing, part i : Bearing stiffness formulation. *Journal*  
700 *of Sound and Vibration*, 139(2):179–199, 1990.
- 701 [21] T.C.Lim R.Singh. Vibration transmission through rolling  
702 element bearing, part ii : System studies. *Journal of Sound*  
703 *and Vibration*, 139(2):201–225, 1990.

- 704 [22] T.C.Lim R.Singh. Vibration transmission through rolling el-  
705 element bearing, part iii : Geared rotor system studies. *Journal*  
706 *of Sound and Vibration*, 151(1):31–54, 1991.
- 707 [23] T.C.Lim R.Singh. Vibration transmission through rolling  
708 element bearing, part iv : Statistical energy analysis. *Journal*  
709 *of Sound and Vibration*, 153(1):37–50, 1992.
- 710 [24] G.Henriot. Quelques réflexions sur la génération du bruit et  
711 des vibrations dans les engrenages. *Mécanique industrielle*  
712 *et Matériaux*, 49(3):125–129, 1996.
- 713 [25] F.Robbe-Valloire R.Progri B.Paffoni R.Gras. Modélisation  
714 de la topologie microgéométrique. *Matériaux et Techniques*,  
715 3-4, 2000.
- 716 [26] R.E.Crochiere L.R.Rabiner. Multi-rate signal processing.  
717 *Prentice-Hall*, pages 88–91, 1983.
- 718 [27] H.Hertz. Ueber die beruhung fester elastischer korper.  
719 *Journal fur die reine und angewandte, Section Mathematic*,  
720 92:156–171, 1881.
- 721 [28] T.A. Harris. Rolling bearing analysis. *John Wiley and Sons*,  
722 1991.
- 723 [29] J.-L.Dion J.-B.Casimir. Modélisation du comportement  
724 dynamique de clapets de compresseurs en état flexible.  
725 *Mécanique et Industrie*, 4:125–132, 2003.
- 726 [30] P.Dahl. Solid friction damping of mechanical vibrations.  
727 *AIAA Journal*, 14(2):1675–1682, 1976.
- 728 [31] C.Canudas de Wit H.Olsson K.J.Aström P.Lischinsky. A  
729 new model for control of systems with friction. *IEEE Trans-*  
730 *actions on automatic control*, 40(3), 1995.

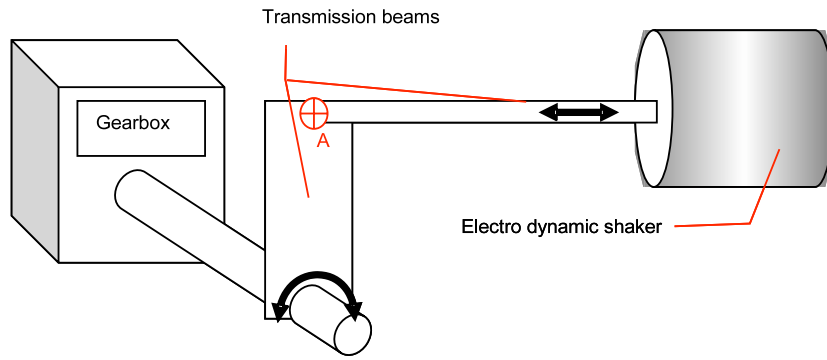

Fig .1. Schematic diagram of the experimental setup

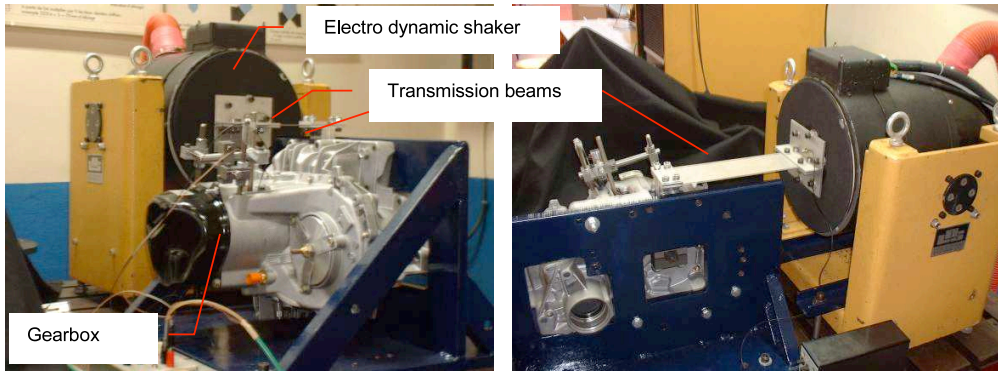

Fig .2. Pictures of the experimental setup

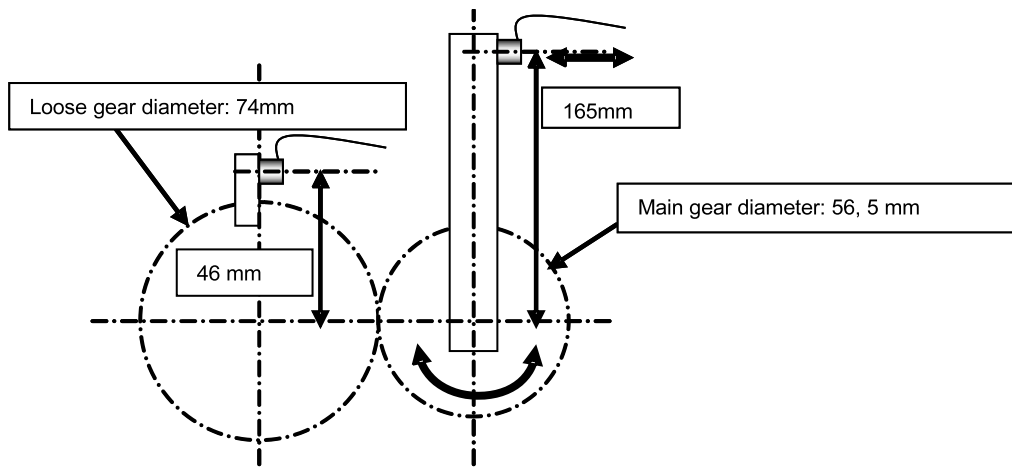

Fig .3. Schematic diagram of gear configuration

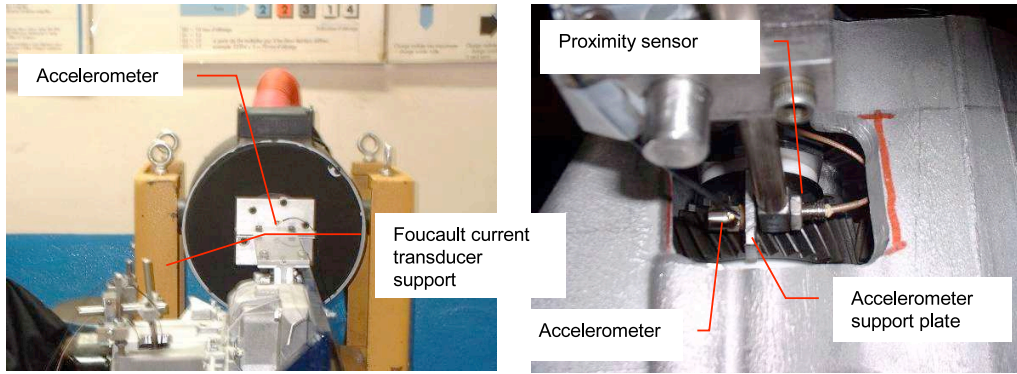

Fig .4. Intrumentation

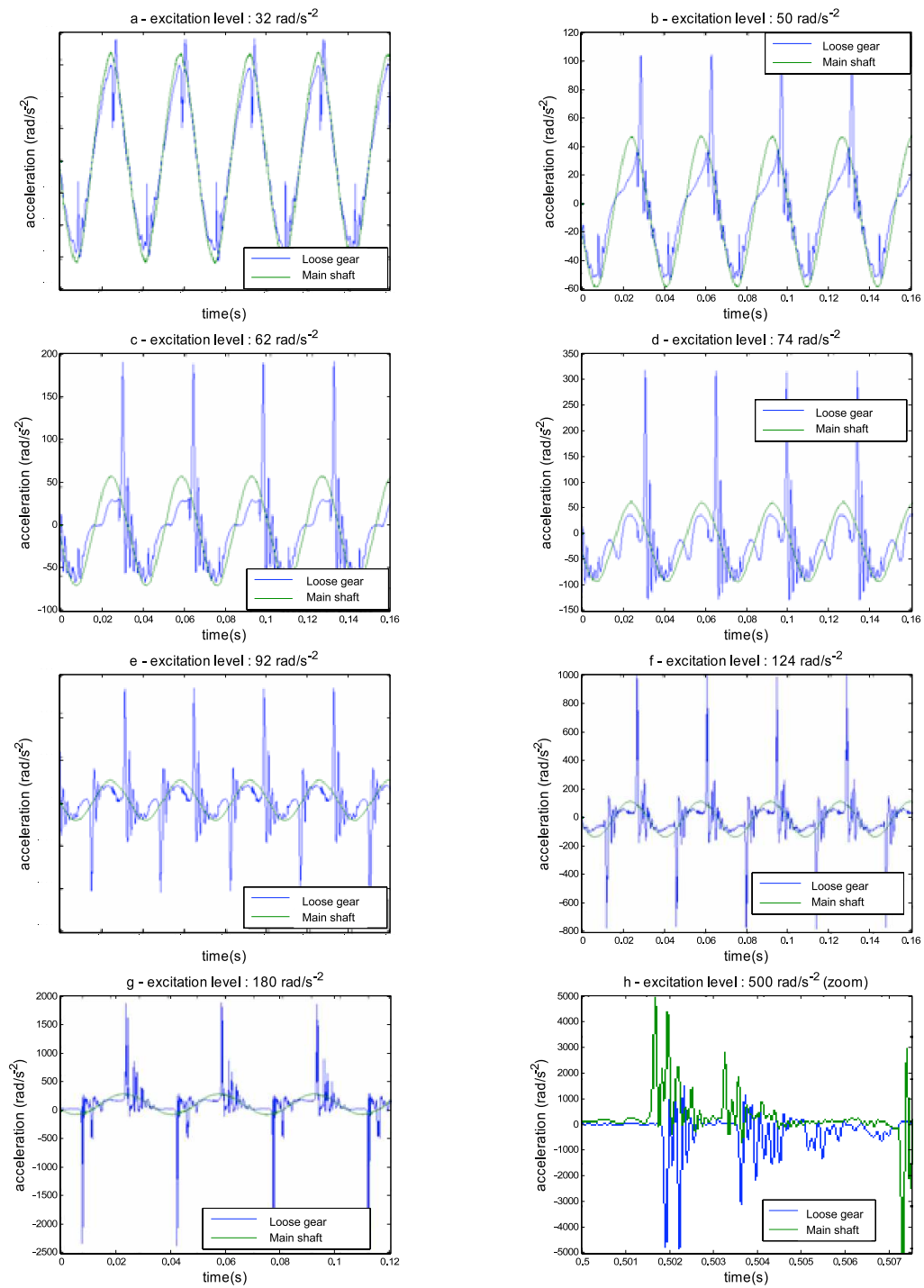

Fig .5. Temporal signals for different levels of a 30 Hz excitation



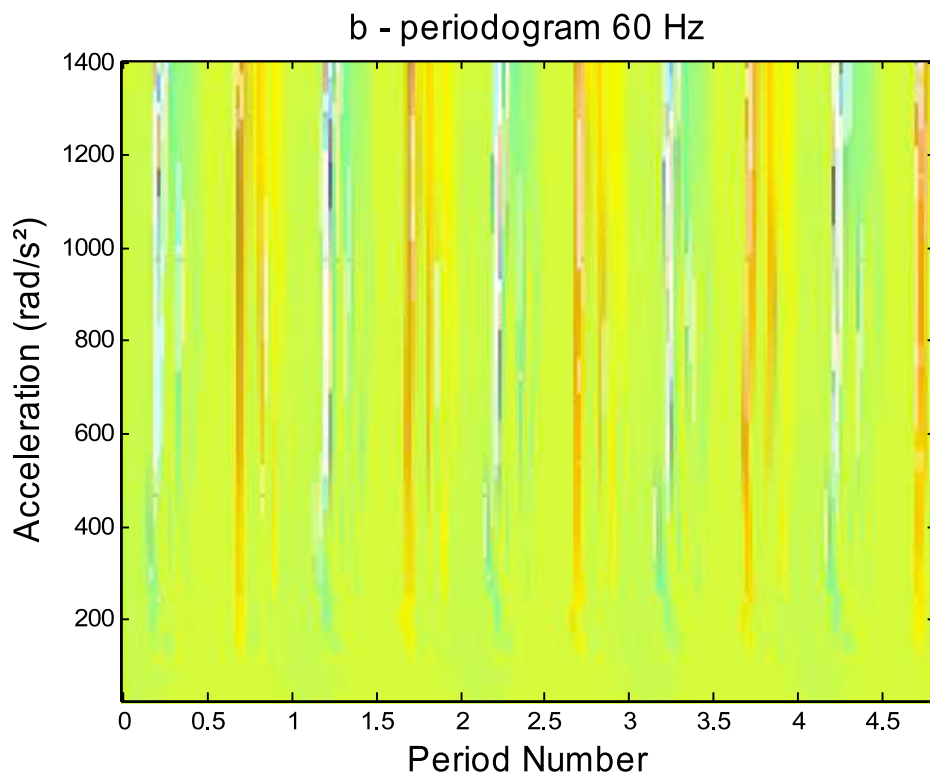
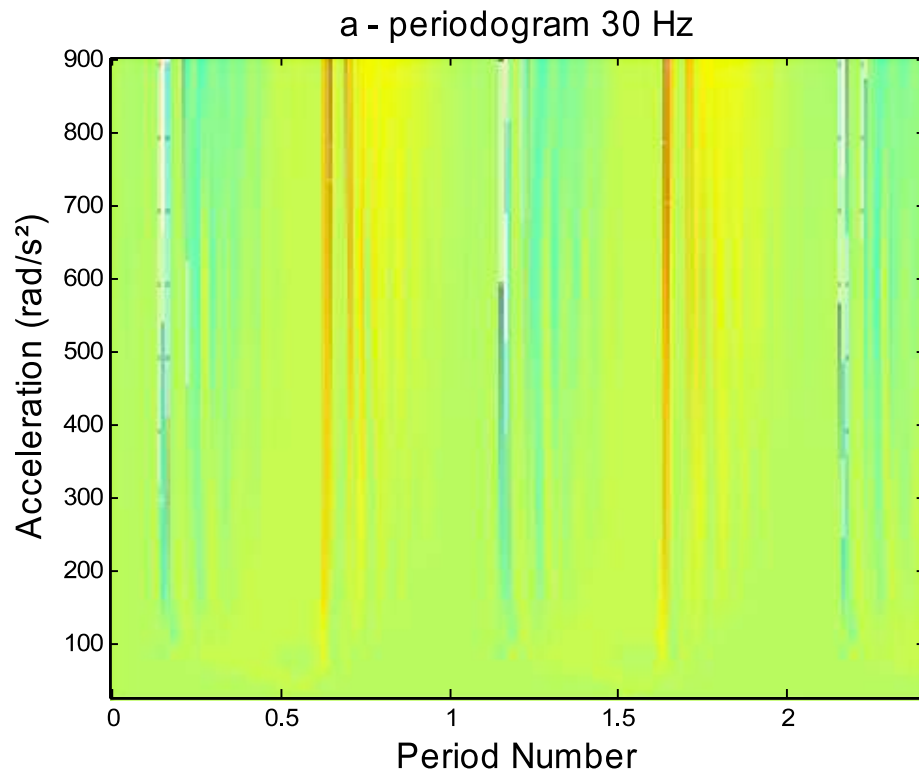

Fig .6. Evolution of shocks shape versus excitation level, for two different excitation frequencies. "Periodograms".

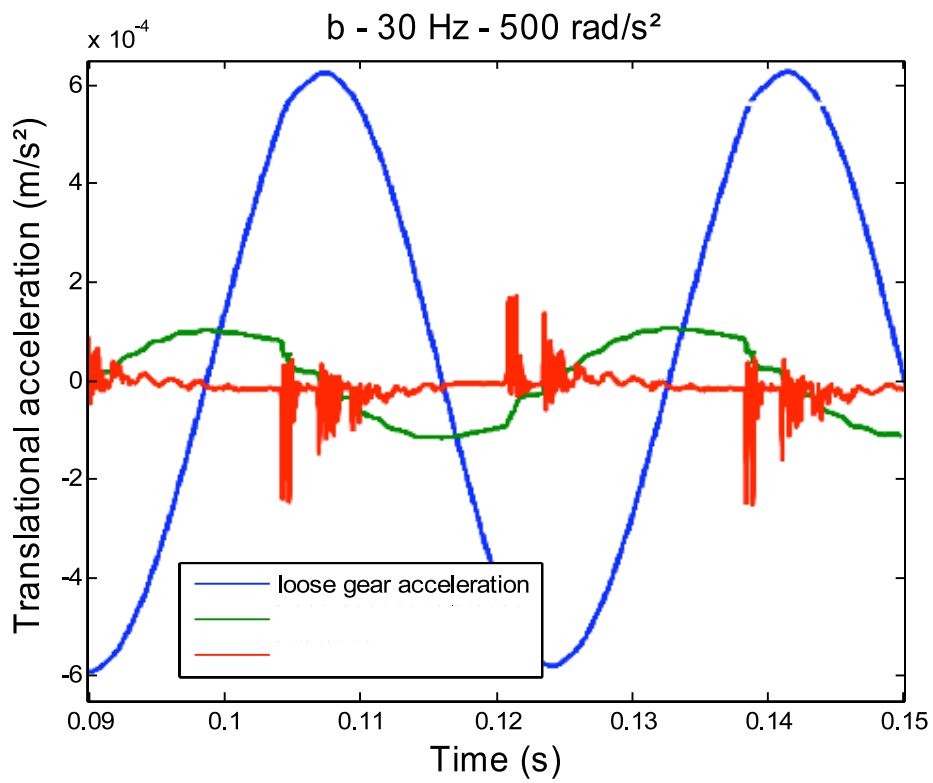
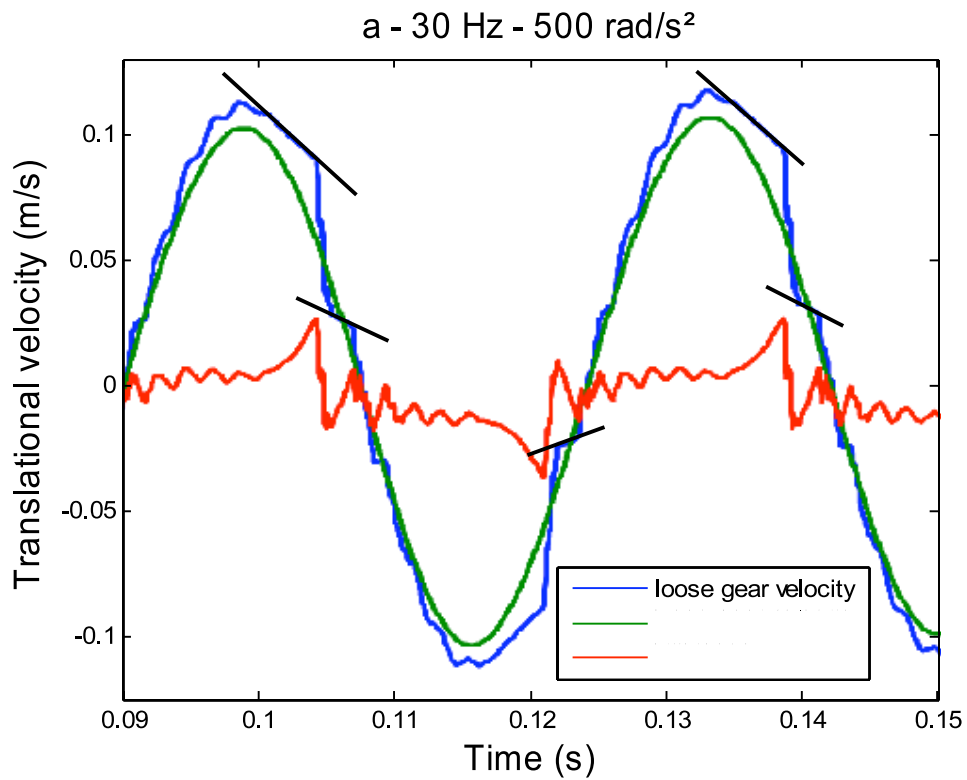

Fig .7. Kinetical gear behaviour for a 30 Hz - 500rad/s<sup>2</sup> excitation

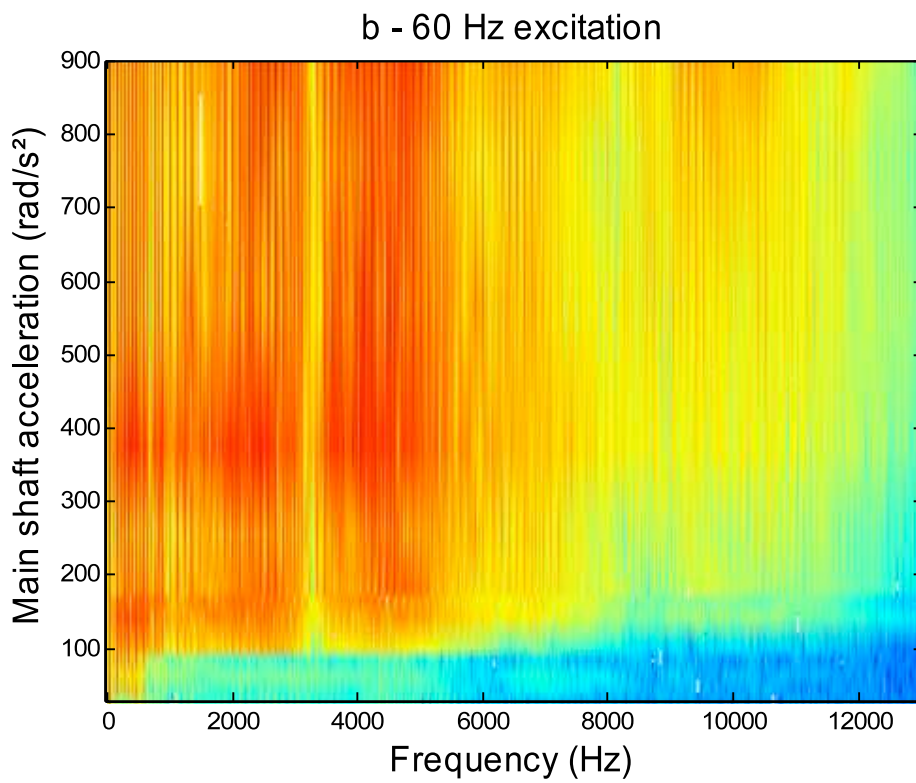
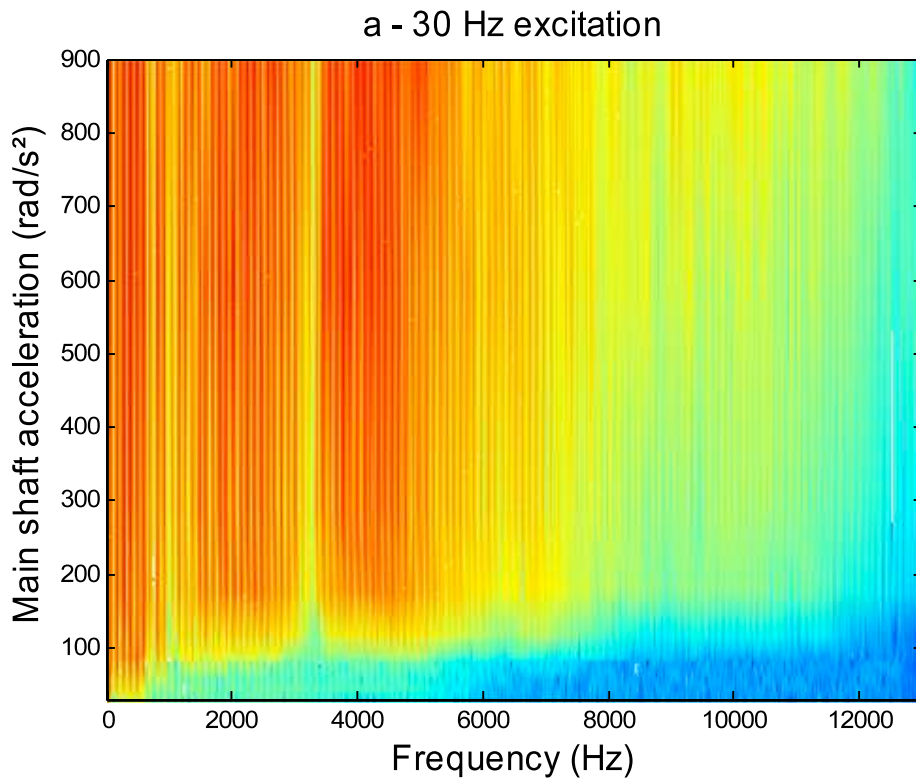

Fig .8. Evolution of loose gear acceleration spectral shape versus main shaft acceleration level

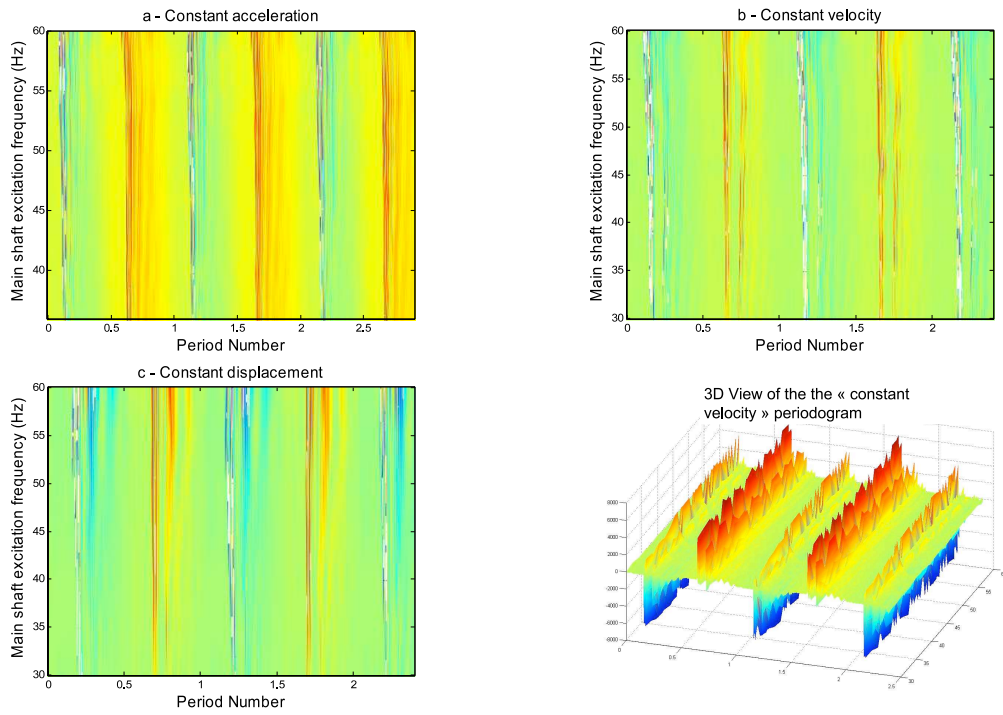

Fig .9. Loose gear acceleration shape evolution according to excitation frequency

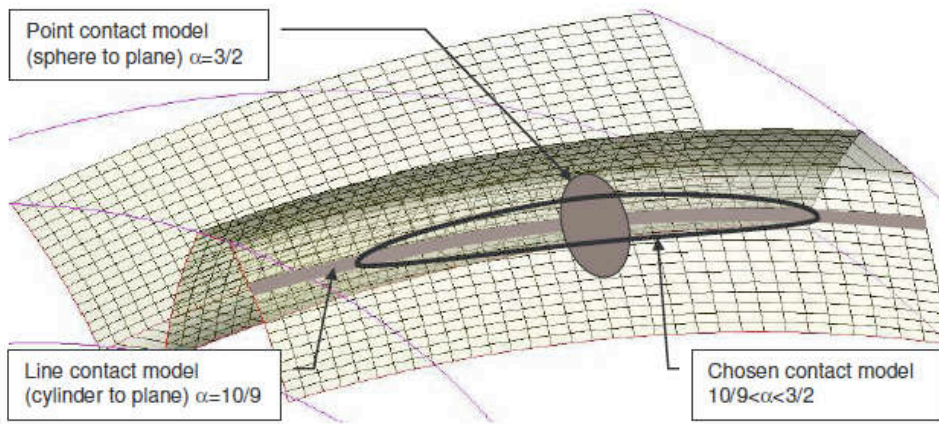

Fig .10. Contact areas for several models

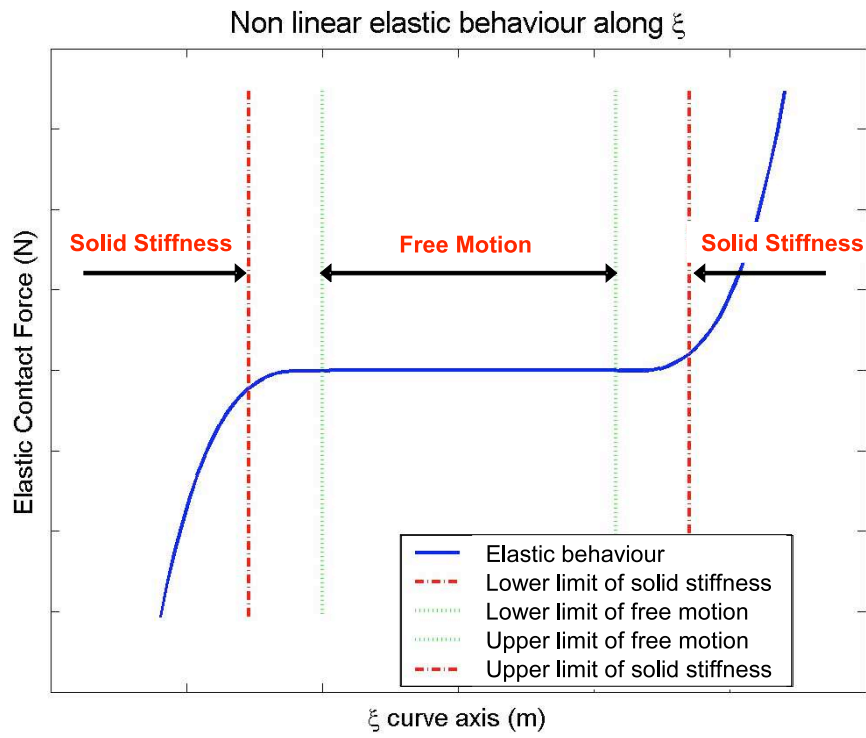

Fig .11. Elastic Behaviour on pitch perimeter

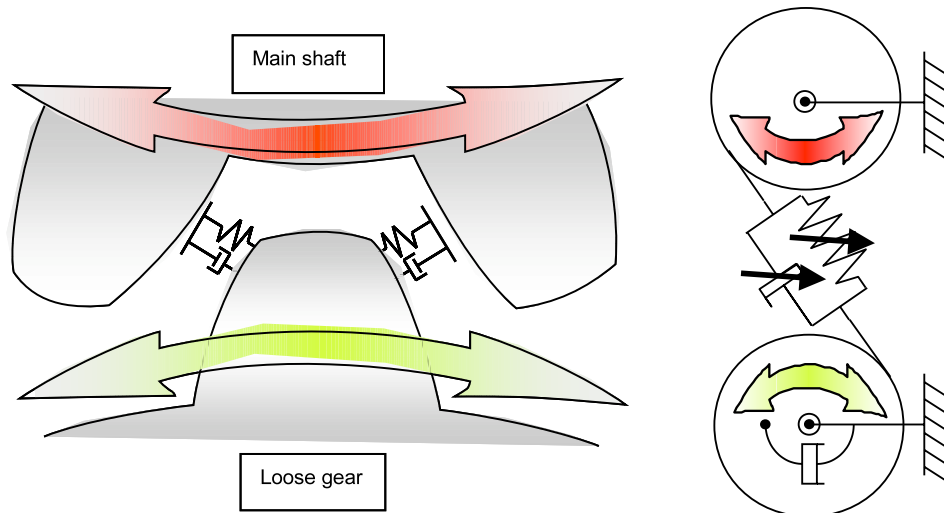

Fig .12. Schematic representations of gears in contact

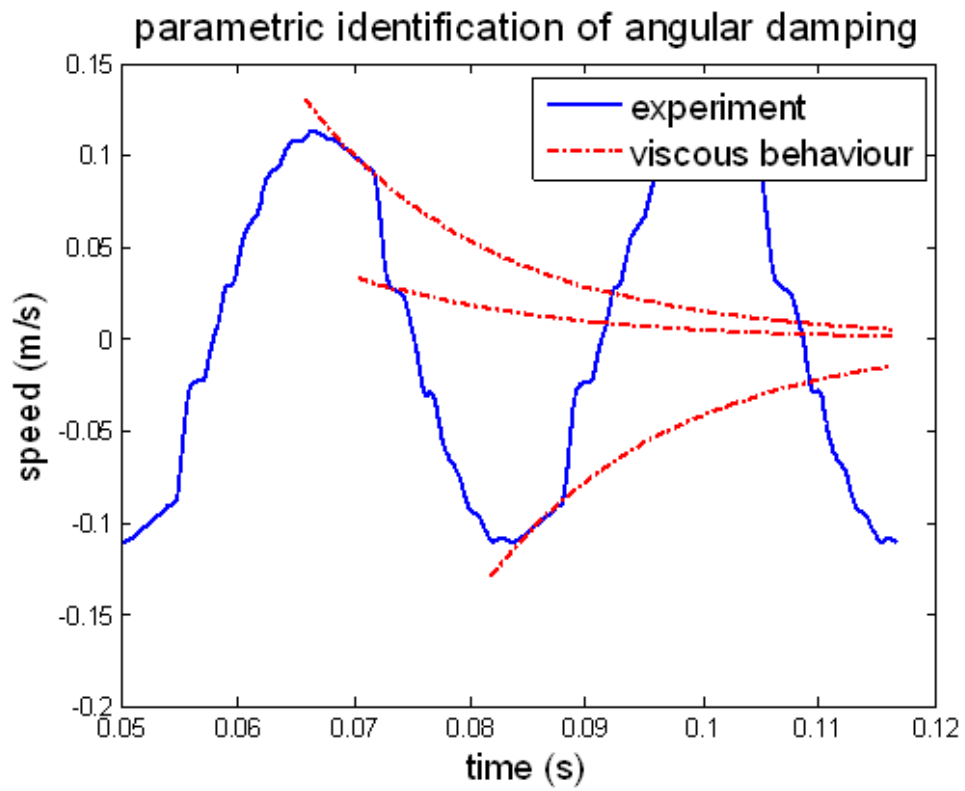

Fig .13. Parametric identification of rational damping based on experimental results



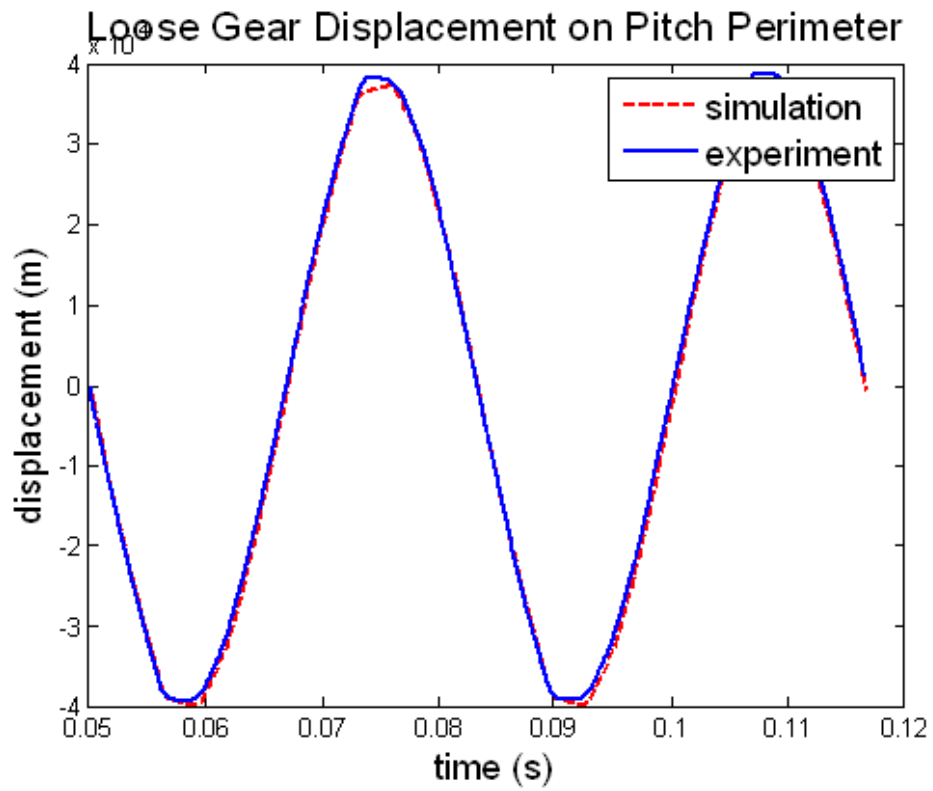

Fig .14. Comparison between measurements and simulation - Displacements for 30 Hz and  $300 \text{ Rad s}^{-2}$

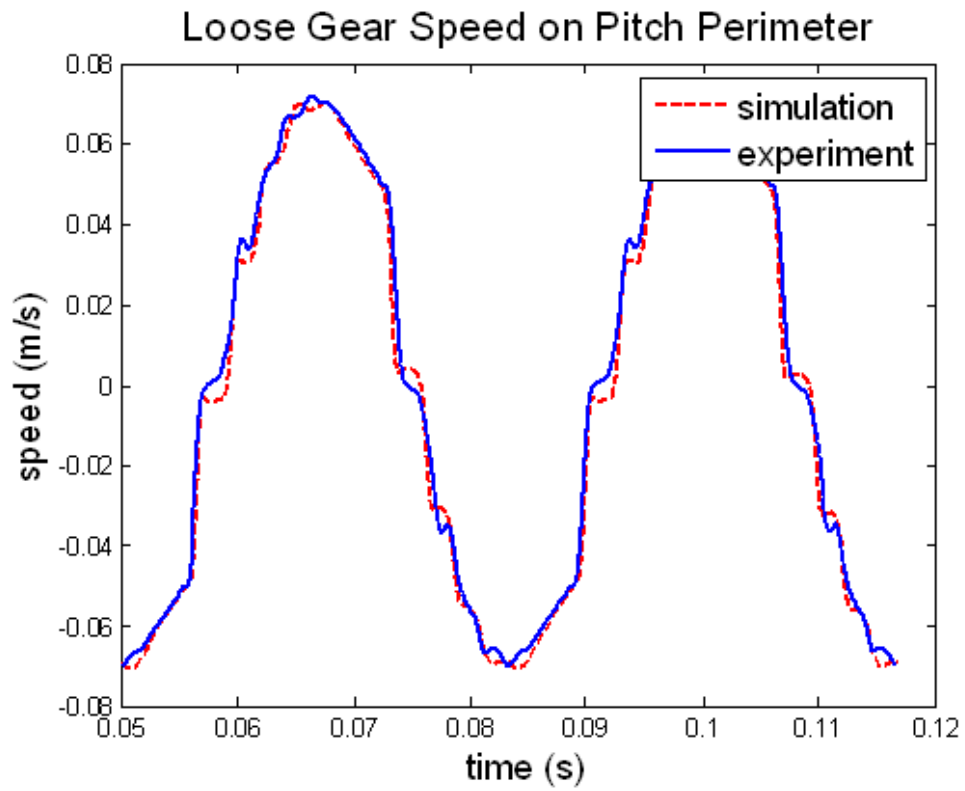

Fig .15. Comparison between measurements and simulation - Velocity for 30 Hz and  $300 \text{ Rad s}^{-2}$

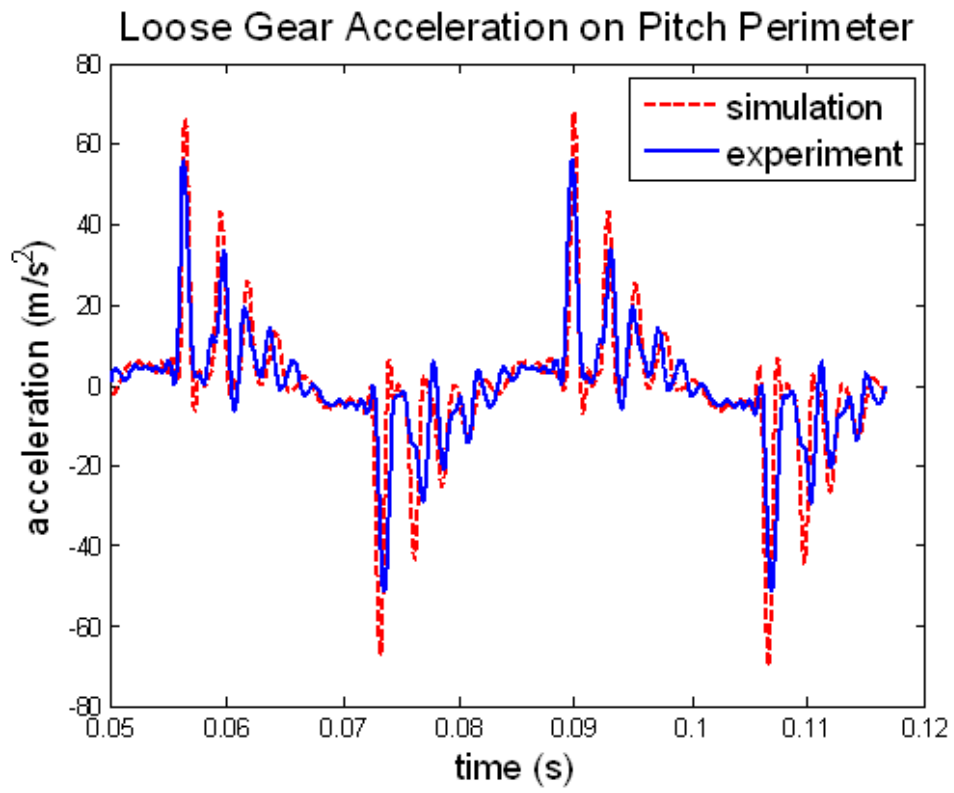

Fig .16. Comparison between measurements and simulation - Acceleration for 30 Hz and 300 Rad  $s^{-2}$

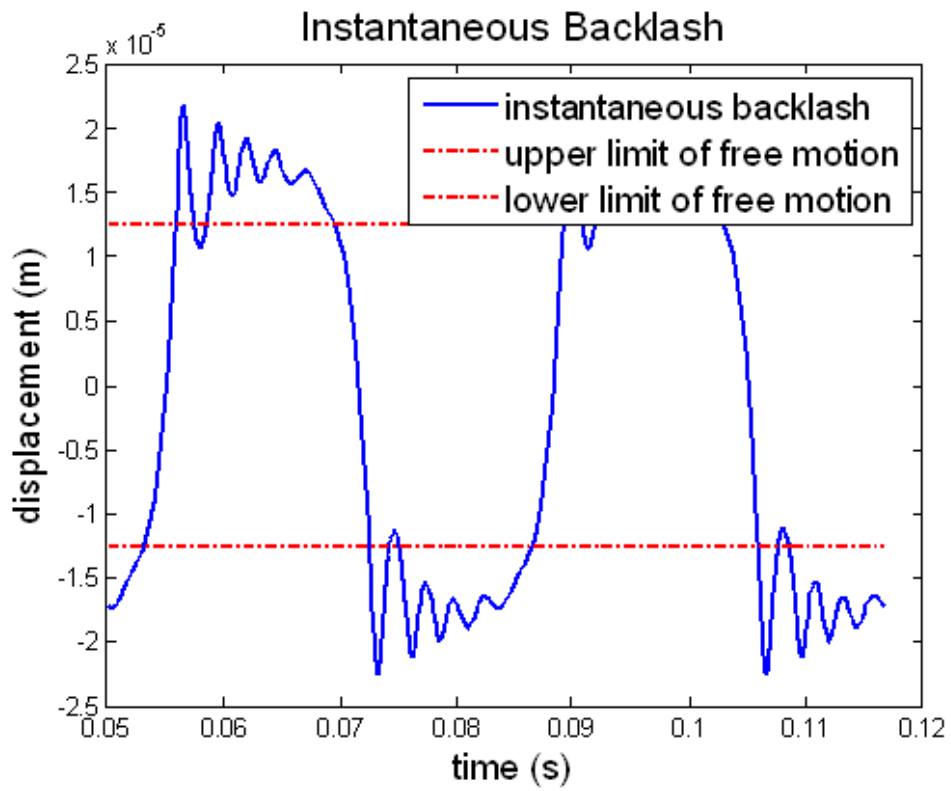

Fig .17. Relative displacement (instantaneous backlash) for 30 Hz and 300 Rad s<sup>-2</sup>

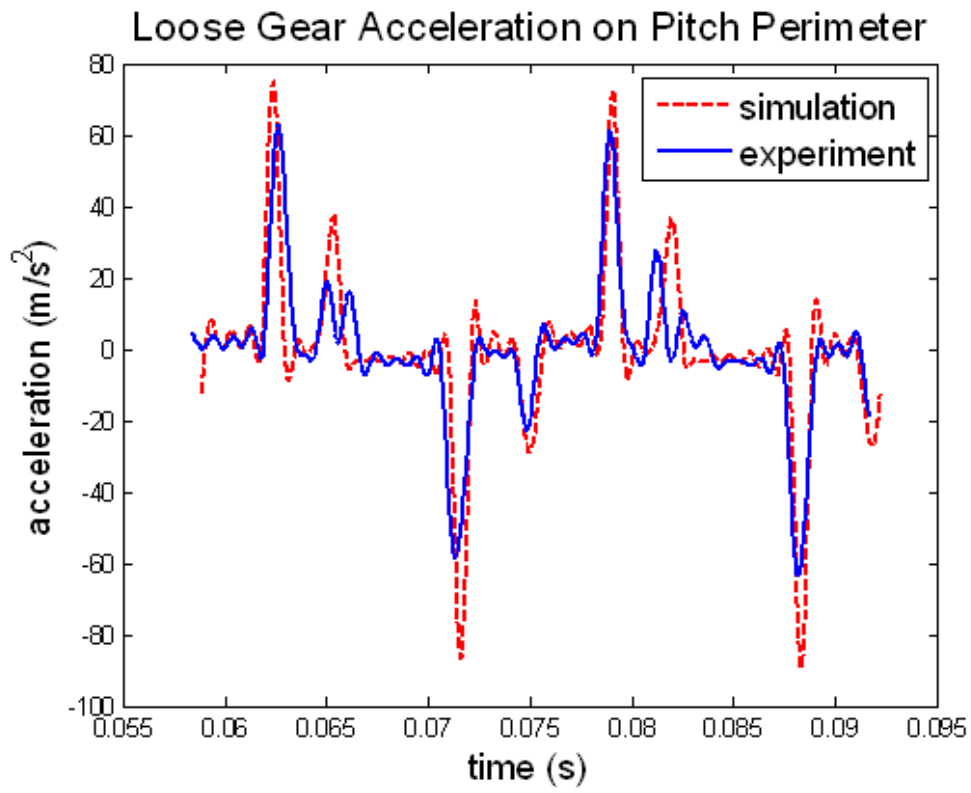

Fig .18. Comparison between measurements and simulation - Acceleration for 60 Hz and  $300 \text{ Rad.s}^{-2}$

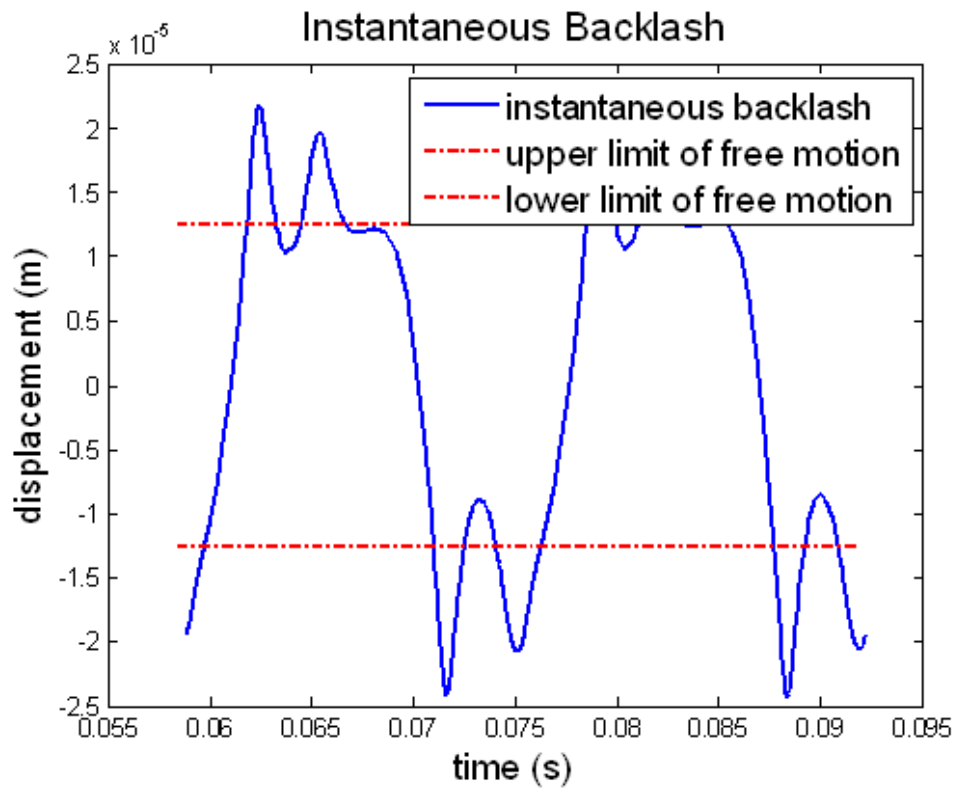

Fig .19. Comparison between measurements and simulation - Relative displacement (instantaneous backlash) for 60 Hz and 300 Rad s<sup>-2</sup>

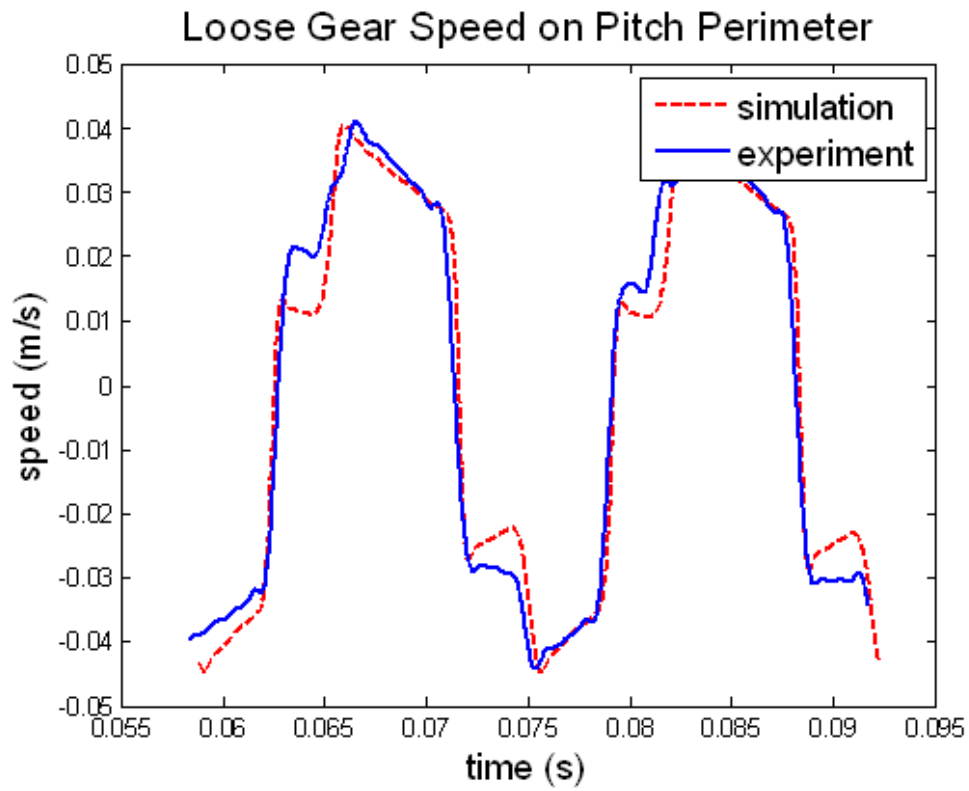

Fig .20. Comparison between measurements and simulation - Velocity for 60 Hz and 300 Rad s<sup>2</sup>

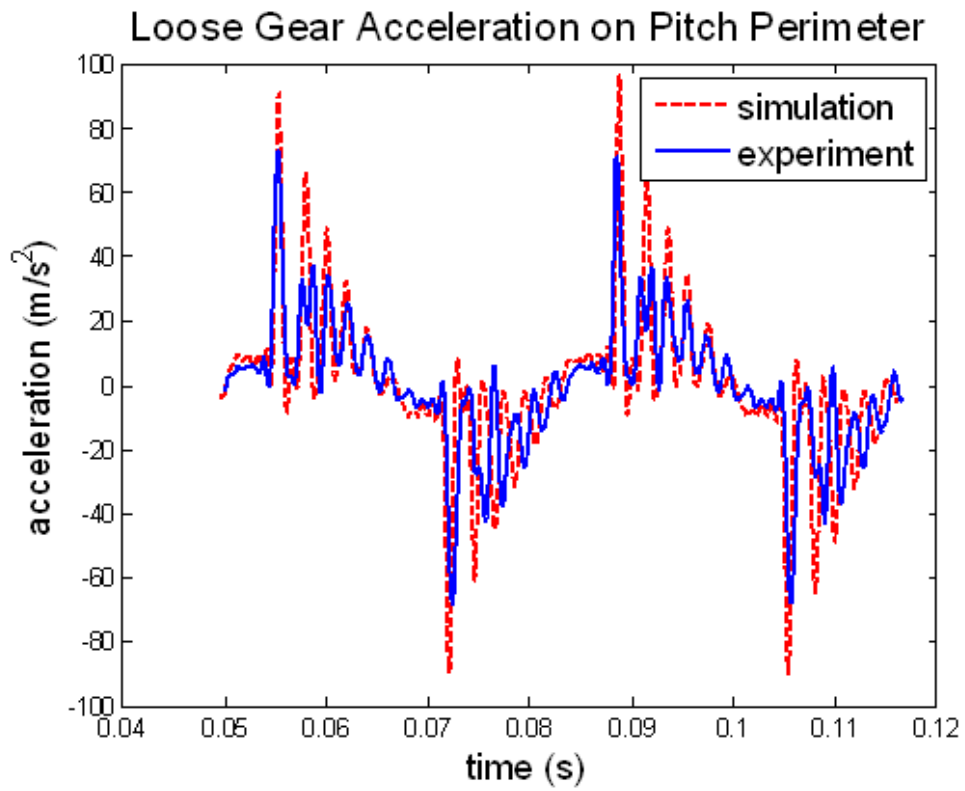

Fig .21. Comparison between measurements and simulation - Acceleration for 30 Hz and 500 Rad  $s^2$



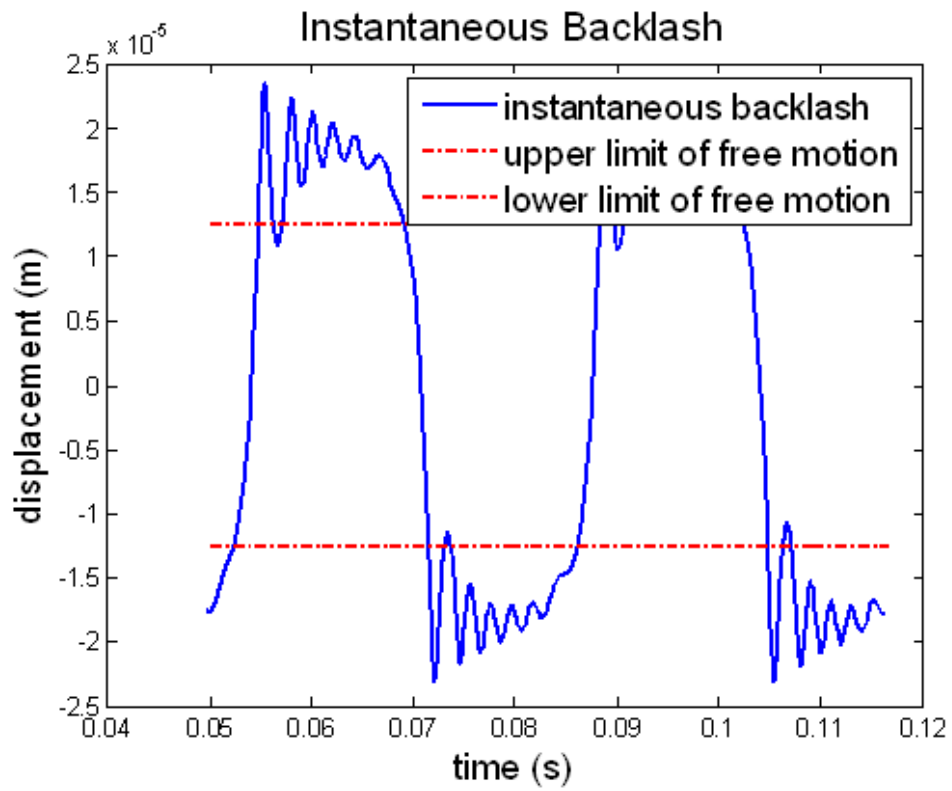

Fig .22. Comparison between measurements and simulation - Relative displacement (instantaneous backlash) for 30 Hz and 500 Rad s<sup>2</sup>

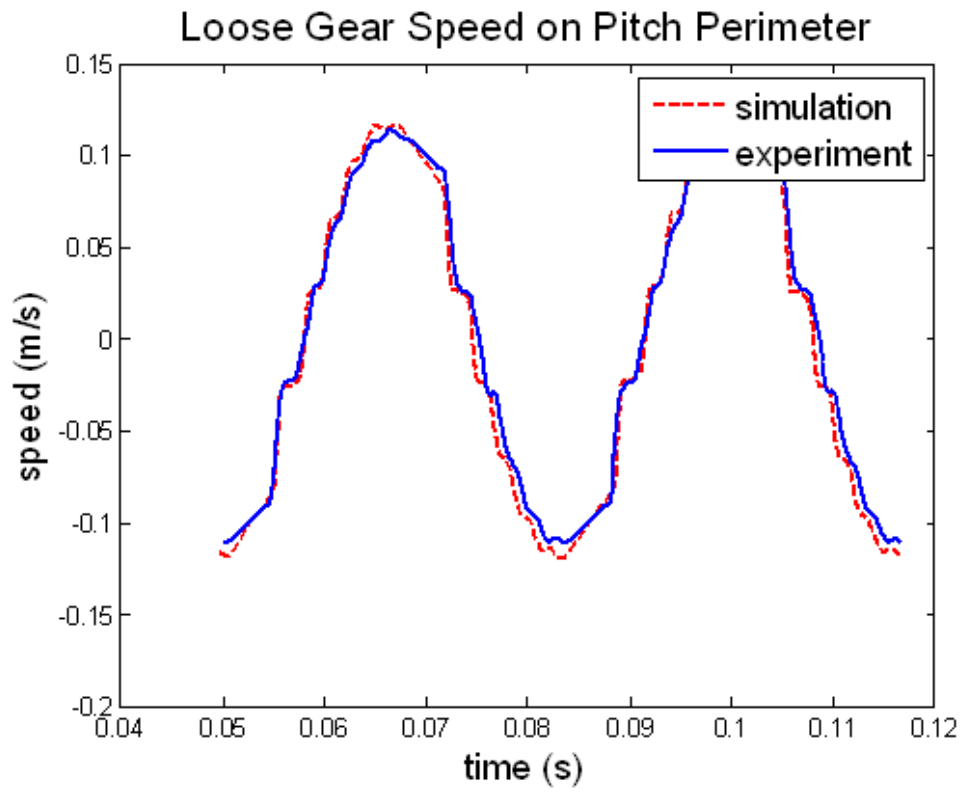

Fig .23. Comparison between measurements and simulation - Velocity for 30 Hz and 500 Rad s<sup>2</sup>

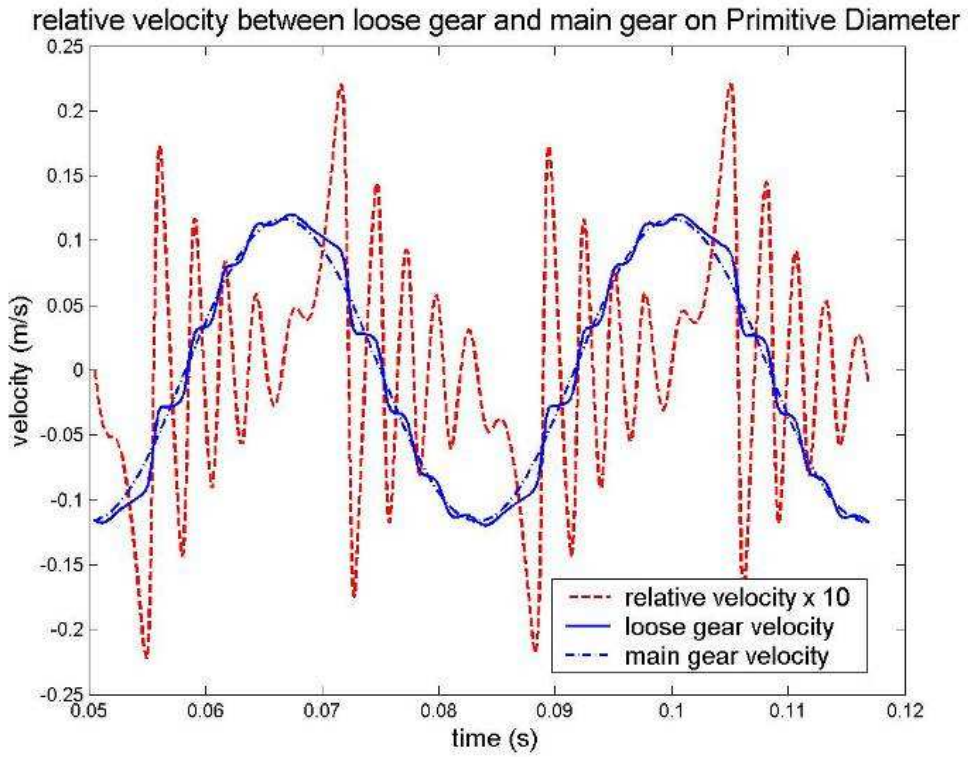

Fig .24. Relative velocity - Velocities for 30 Hz and 500 Rad s<sup>2</sup>

731 **List of Figures**

732	.1	Schematic diagram of the experimental setup	27
733	.2	Pictures of the experimental setup	28
734	.3	Schematic diagram of gear configuration	29
735	.4	Intrumentation	30
736	.5	Temporal signals for different levels of a 30 Hz	
737		excitation	31
738	.6	Evolution of shocks shape versus excitation	
739		level, for two different excitation frequencies.	
740		"Periodograms".	32
741	.7	Kinetical gear behaviour for a 30 Hz - 500rad/s <sup>2</sup>	
742		excitation	33
743	.8	Evolution of loose gear acceleration spectral	
744		shape versus main shaft acceleration level	34
745	.9	Loose gear acceleration shape evolution according	
746		to excitation frequency	35
747	.10	Contact areas for several models	36
748	.11	Elastic Behaviour on pitch perimeter	37
749	.12	Schematic representations of gears in contact	38
750	.13	Parametric identification of rational damping	
751		based on experimental results	39
752	.14	Comparison between measurements and	
753		simulation - Displacements for 30 Hz and 300	
754		Rad s <sup>-2</sup>	40

755	.15	Comparison between measurements and simulation - Velocity for 30 Hz and 300 Rad s <sup>-2</sup>	41
756			
757	.16	Comparison between measurements and simulation - Acceleration for 30 Hz and 300 Rad s <sup>-2</sup>	42
758			
759			
760	.17	Relative displacement (instantaneous backlash) for 30 Hz and 300 Rad s <sup>-2</sup>	43
761			
762	.18	Comparison between measurements and simulation - Acceleration for 60 Hz and 300 Rad.s <sup>-2</sup>	44
763			
764			
765	.19	Comparison between measurements and simulation - Relative displacement (instantaneous backlash) for 60 Hz and 300 Rad s <sup>-2</sup>	45
766			
767			
768	.20	Comparison between measurements and simulation - Velocity for 60 Hz and 300 Rad s <sup>2</sup>	46
769			
770	.21	Comparison between measurements and simulation - Acceleration for 30 Hz and 500 Rad s <sup>2</sup>	47
771			
772			
773	.22	Comparison between measurements and simulation - Relative displacement (instantaneous backlash) for 30 Hz and 500 Rad s <sup>2</sup>	48
774			
775			
776	.23	Comparison between measurements and simulation - Velocity for 30 Hz and 500 Rad s <sup>2</sup>	49
777			
778	.24	Relative velocity - Velocities for 30 Hz and 500 Rad s <sup>2</sup>	50
779			