



HAL
open science

A mechanical modeling strategy for squeal prediction on industrial railway brakes

Xavier Lorang, Andréa Loyer, Olivier Chiello, Sandrine Bouvet, Nicolas Vincent, Guillaume Vermot Des Roches, Etienne Balmès

► **To cite this version:**

Xavier Lorang, Andréa Loyer, Olivier Chiello, Sandrine Bouvet, Nicolas Vincent, et al.. A mechanical modeling strategy for squeal prediction on industrial railway brakes. 9th World Congress on Railway Research, May 2011, Lille, France. pp.1-7. <hal-00705887>

HAL Id: hal-00705887

<https://hal.science/hal-00705887v1>

Submitted on 1 Jul 2025

HAL is a multi-disciplinary open access archive for the deposit and dissemination of scientific research documents, whether they are published or not. The documents may come from teaching and research institutions in France or abroad, or from public or private research centers.

L'archive ouverte pluridisciplinaire **HAL**, est destinée au dépôt et à la diffusion de documents scientifiques de niveau recherche, publiés ou non, émanant des établissements d'enseignement et de recherche français ou étrangers, des laboratoires publics ou privés.



Distributed under a Creative Commons CC BY 4.0 - Attribution - International License

A mechanical modeling strategy for squeal prediction on industrial railway brakes

X. Lorang¹, A. Loyer^{1,2,3}, O. Chiello², J.J. Sinou³,
S. Bouvet⁴, N. Vincent⁴, G. Vermot des roches⁵, E. Balmes⁵

¹SNCF, Paris, France ; ²IFSTTAR, Bron, France ; ³ECL-LTDS, Lyon, France ; ⁴VIBRATEC, Ecully, France; ⁵SDTOOLS, Paris, France

1. Introduction

The squeal noise generated by railway disc brakes is a daily source of discomfort for the passengers both inside and outside the trains in stations. The development of silent brake components is needed but beforehand requires a better characterization and understanding of the phenomenon. The acoustic levels reached on platforms leads operators to include noise specifications in their standards. In this context, the project AcouFren propose to define tool to help in the pad specification process (according to squeal) and design. The goal is also to apply the tool to build new design of pads and to test it.

To be able to build such a tool, prediction of the behavior of the brake must be reached in terms of vibration and noise. The present paper describes first the architecture of the project. It concentrates after on numerical methods dedicated to transient computations for industrial models (part of the task 1). The paper finishes presenting the brake components characterization needed to build industrial models (task 2).

2. Architecture of the AcouFren Project

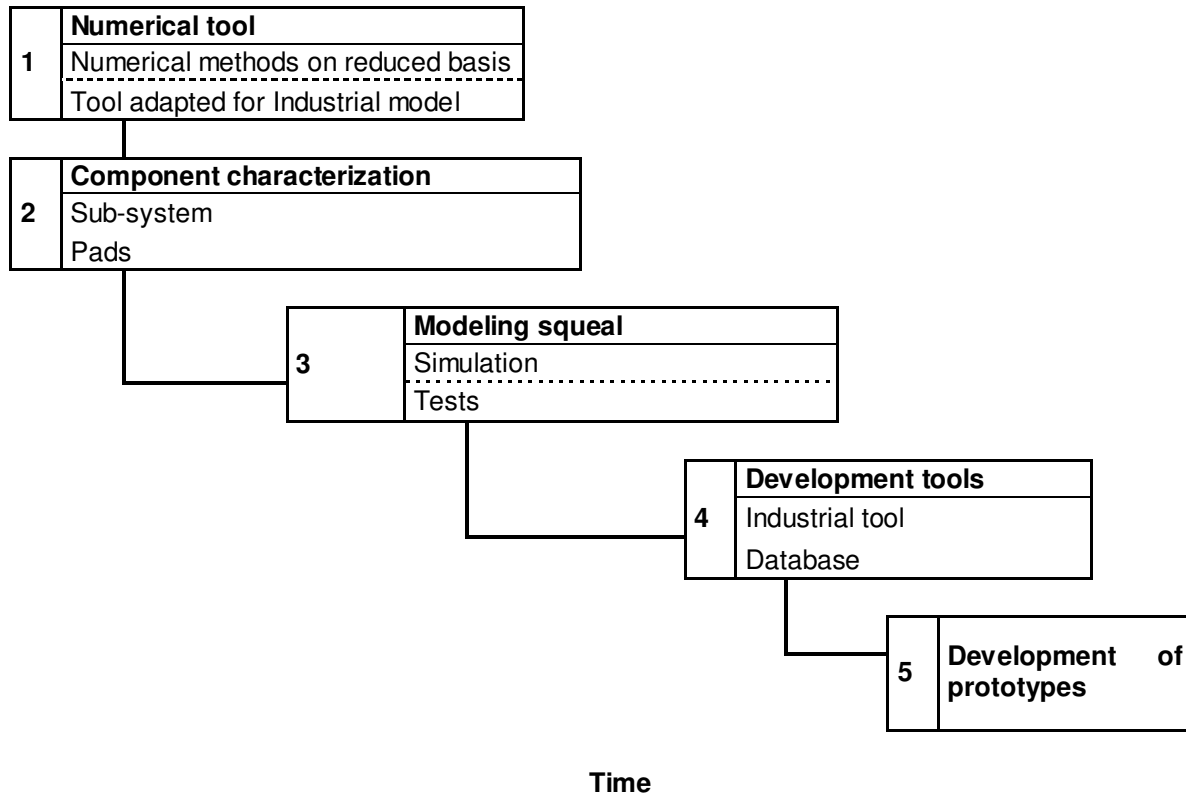

The project is divided in 5 tasks.

The first one concern the development of a research tool to model vibration instabilities at the origin of disc brake squeal. A work about the evaluation of numerical methods is proposed to reduce computational costs.

In parallel, these numerical methods will be integrated in efficiency research software for industrial applications. These methods will be applied on a railway benchmark.

The task 2 concerns the experimental characterization and the modeling of subsystems of the braking system TGV (axle mounted disc) and AGC (wheel mounted disc). The work is planned here to consider a set of 10 pads. The set has been created to represent diversity in terms of mechanical behavior. The objective is to create variability in the behavior of pads because its effect on squeal is looked for.

In the task 3, it is planned to use the tools developed in the task 1 with the mechanical models developed in the task 2. For both TGV and AGC brake architecture, it is planned to :

- propose a validated coupled mechanical model
- use it to simulate friction induced vibrations
- to compute acoustic fields from vibrations
- to compare simulation results to test bench results for the set of pads

The results obtained here will help to decide choices to make in the task 4.

The task 4 concerns the development of tools to help in the pad specification process (according to squeal) and design both TGV and AGC brake architecture:

- an industrial prediction tool (simplified) of squeal noise
- a squeal database and an experimental method to fill it.

The task 5 is dedicated to the development of pad prototypes. Goals are to propose 2 prototypes for TGV and 2 prototypes for AGC. To reach it, the industrial tool developed in the task 4 will be used by the partner in charge of prototypes. A validation procedure is proposed with the test bench.

3. Reduction methods for squeal simulations

The objective of this work is to obtain theoretical and numerical results on the ability of numerical methods to compute vibration instabilities over reduced basis.

Modeling vibration instabilities consist in compute transient vibration when pads are sliding over the disc. Stability computation is a predictive indicator on squeal occurrence and can potentially give a good reduced basis for transient computation.

From the state of the art [1,2,3,4] methods are available and have been used to compute sliding stationary equilibrium, stability of equilibrium and the transient dynamic solution on complete basis (Finite Element basis). This was made in the assumption of non regularized contact law with Coulomb friction. The work presented here is dedicated to the comparison between solutions computed on reduced basis and solution computed on complete basis. The case of a simplified brake model has been chosen.

The mechanical model is presented figure 2(a) : it is a simplified TGV disc brake model (30000 degrees of freedom). Simple limit conditions are used to model the rest of the components of the brake: for the pads, each little cylindrical parts are fixed on their circular surface. A piecewise Rayleigh damping model is taken ($[C] = \alpha [M] + \beta [K]$) (see on table 1 for α and β values). It is possible to find in the table 1 the material properties: it has been chosen to be representative of identified values on different TGV brake pads. The static equilibrium and the stability has been computed of a friction coefficient of 0,38 and a rotation velocity $w=4$ rad/s. The non linear time response of the complete system and the reduce one are computed and compared.

For the reduction, the choice has been made to use the complex modes coming from the stability analysis instead of the real ones.

The stability of the system is given on the figure 2(b): there is 13 unstable modes. We can see that the unstable modes appear near from pads modes (near 3500 Hz and 11000 Hz). The instability phenomenon is about 11,1 kHz with a growth rate of 5% in 12 unstable modes.

In the low frequency band, only the 3537 Hz unstable mode is present with a growth rate of 0.1 %.

Paramètre	disque	plots
Module de Young E (MPa)	$2.02 \cdot 10^9$	$3 \cdot 10^6$
Coefficient de Poisson ν	0.29	0.3
Masse volumique ρ ($kg.m^{-3}$)	7850	5102
Rayleigh α (s^{-1})	3.75	54.375
Rayleigh β (s)	$5 \cdot 10^{-8}$	$72.5 \cdot 10^{-8}$

Table 1 : Material properties

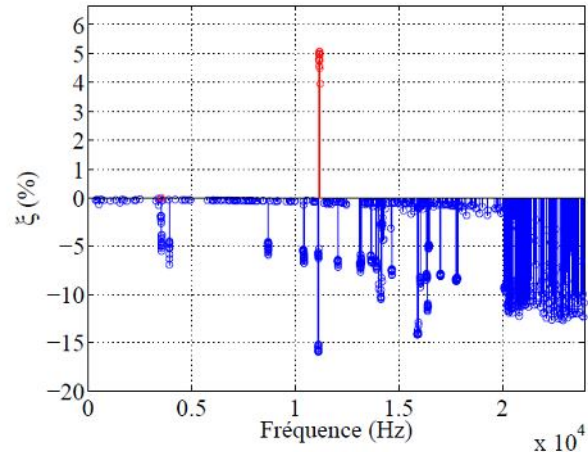
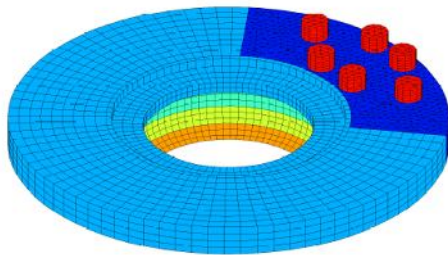

Fig. 2(a) : Mesh of the simplified TGV Brake Model

Fig. 2(b) Stability of the simplified TGV brake model

Previous studies [1,2,3] showed on simplified systems that unstable modes were predominant in the time response and that the non linear stationary dynamic state is generally composed of only some complex modes. In this study, we will focus on the impact of the reduction with a modal truncation using complex modes rather than real modes of the system. We denote FCN the reduction basis where N is the number of included modes. We chose to consider the 461 first complex modes in the basis. The criterion is to catch all the modes which have a frequency less than 1.5 times the maximum frequency of interest (20 kHz). The static equilibrium and the static modes of the contact interface are added in the basis. To be able to treat correctly the contact, the physical interface is not reduced and the generalized degrees of freedom are the traces of the modes outside from the contact zone. To reduce the time simulation, the initial condition is chosen on one of unstable modes. It allows going out faster from the initial static equilibrium.

Results :

The reduced basis used allows dividing by 4 time computation compared to the reference. The figure 3 shows a comparison of displacement and velocity mean fields on the contact zone for the different basis. We can see that the FC461 basis give good results comparing with the reference according to frequencies and amplitudes. A time advance of 2.5 ms is induced by the reduction. This phenomenon can be explained by an over estimation of the growth rate instability with the reduced basis (same kind of result on a 2D problem can be found in [4]).

The figure 4 shows a comparison of spectra on the last 2.5 ms. It can be noted that for both calculations, the main frequency around 11 kHz (10.8 kHz) corresponds to the 3rd order harmonic frequency of the low frequency. An over estimation of the levels at $f_1 = 10.8$ kHz, $2 f_1$ and $3 f_1$ is visible.

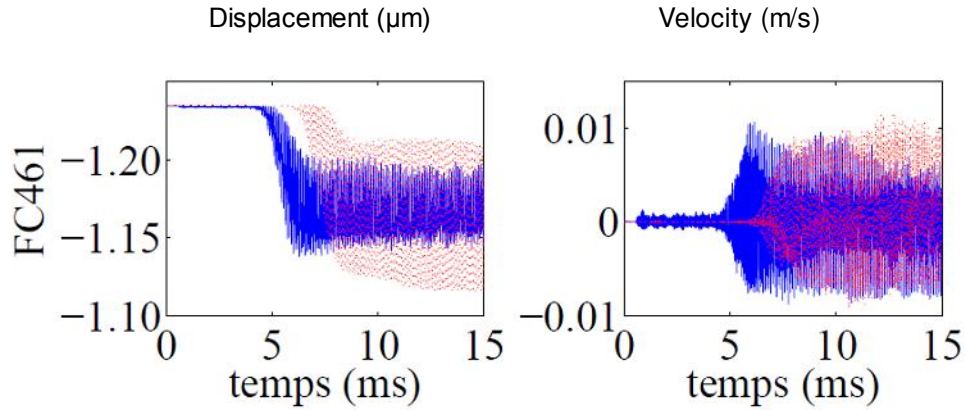

Fig 3: Comparison of displacement and velocity mean fields on the contact zone

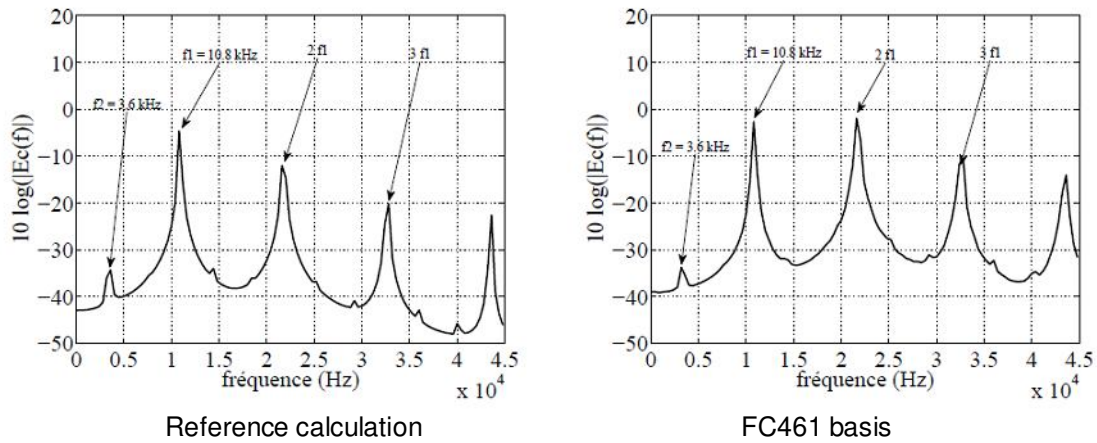

Fig 4 : Global kinetic energy on the brake in frequency domain

A time simulation on reduced basis applied to a simplified TGV brake model has been presented. It shows that a basis including the 461 first complex stability modes is able to catch the good behavior. Other results can be found in [5].

4. Component characterization

The task 2 consists to furnish to the project, FEM models representative of the different components of the brake system. These models must be able to describe the modal behavior of these components on the frequency band of interest for squeal.

The components are (for TGV and AGC trains) :

- disc brake,
- the whole « pad + pad support + caliper » and
- the friction material of pad (for a set of 10 pads)

Experimental characterization of each of these components has been done and models have been adjusted to experiments using adapted « fitting methods ». In the following, a synthesis of the results obtained on each of the 3 component groups is presented (TGV only).

4.1 : TGV disc brake

A FEM model of the disc has been developed and an experimental modal analysis has been conducted until 15 kHz. The figure 5 shows an experimental mesh of the disc (a) and an identified FEM mode.

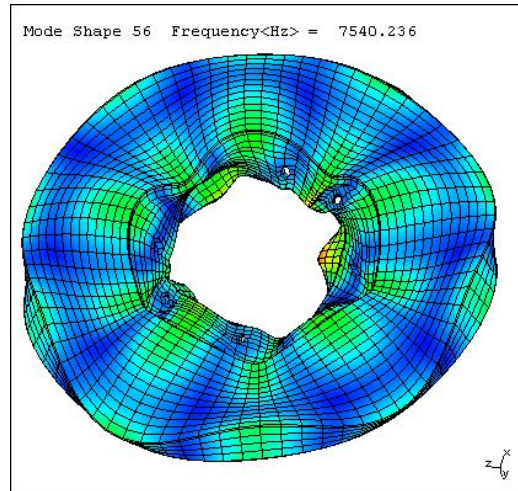

Fig 5 : (a) experimental mesh of the disc

(b) a FEM identified mode (7540 Hz)

4.2 : The whole « pad + pad support + caliper »

The pad is composed of a friction material which is fixed on a support plate.

This task is especially difficult because of the complexity of the dynamic behavior of this whole system. There is a lot of links between the components:

- links between the friction material and the support plate,
- link between the support plate and the pad support
- joints between the pad support, the caliper and the bogie.

Some partial characterization has been proposed to better fit some parts of the system:

- pad alone (fig 6)
- pad support alone
- caliper with and without pad

This characterization has been conducted on a caliper clamped with a representative brake load to be near the real link conditions. Here, the disc has been replaced by 2 plates in elastomer material.

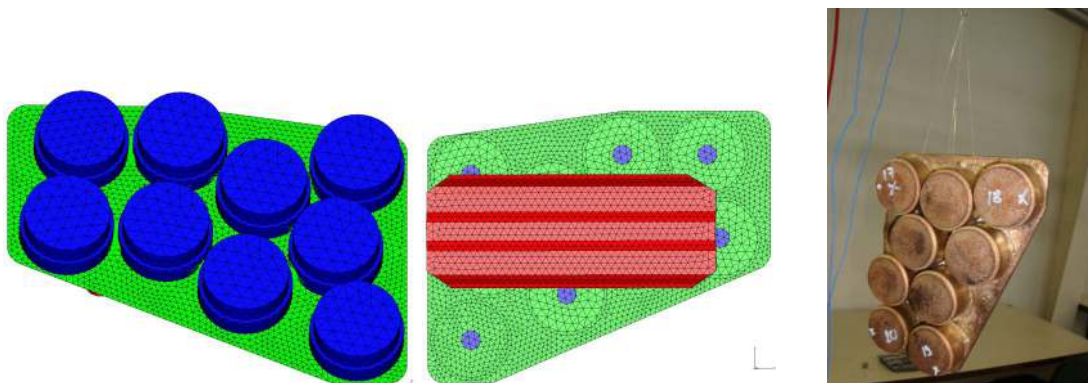

Fig 6 : a pad (real one + FEM) from the set of pad

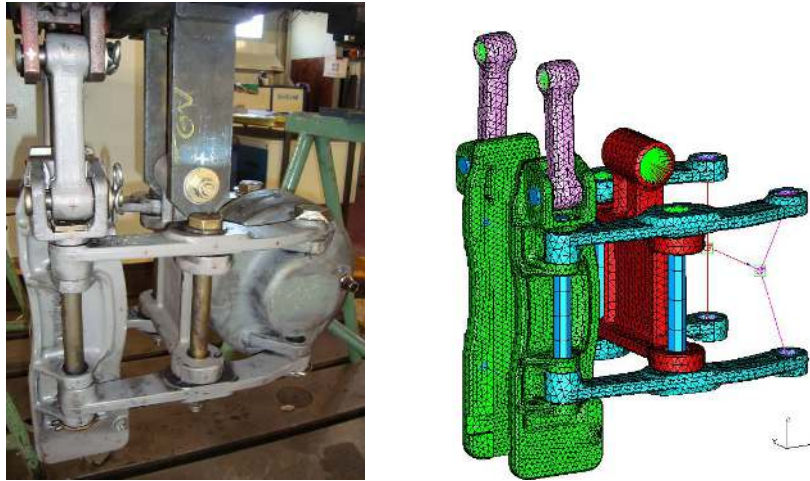

Fig. 7 – (a) « caliper + pad support » (b) mesh of the FEM Model

10 pads have been mesh and studied. A fitted « pad + pad support + caliper » model has been developed (Fig 7). This model describes correctly the first modes of the entire structure.

4.3 : Experimental characterization of the friction material of pads

The objective is to measure the dynamic properties of a set of 10 friction materials associated to 10 pads:

- dynamic stiffness (axial and tangential) and associated damping values,
- extraction with FEM models of Young's modulus and shear modulus from dynamic stiffness measurements.

The main results are:

- Young's modulus and shear modulus are not dependent of the preload during brake phase,
- It can depends on the amplitude of the dynamic excitation,
- It doesn't depend of the frequency,
- Young's modulus are from 1.2 to 8 GPa,
- Damping values are from 2 % to 8 % (tangent of the phase between displacement and force excitation).

5. Conclusions

The AcouFren will propose tools to help in the pad specification process (according to squeal) and design. One of the goals is to propose numerical tools that must be predictive. The architecture of the project has been presented and highlights the proposed strategy. Numerical methods dedicated to transient computations for industrial models have been discussed: the computation on a reduced basis applied on a simplified TGV brake has shown its efficiency.

To finish, it has been presented the brake components characterization needed to build industrial models : complex results have been obtained according to pad behavior.

Acknowledgments

The authors gratefully acknowledge ADEME (Agence De l'Environnement et de la Maîtrise de l'Energie) who has partially funded this project.

Bibliography

[1] Projet PREDIT-ADEME : CRISFIS : CRISsement et FISsuration des freins à disques haute puissance pour le ferroviaire, Mai 2008, Convention ADEME : 04 66 C0063.

[2] Xavier Lorang. *Instabilité vibratoire des structures en contact frottant : Application au crissement des freins de TGV*. PhD thesis, École Polytechnique, 2007.

[3] Xavier Lorang and Olivier Chiello. Stability and transient analysis in the modelling of railway disc brake squeal. In *Noise and Vibration Mitigation for Rail Transportation Systems*, volume 99 of *Notes on Numerical Fluid Mechanics and Multidisciplinary Design*, pages 447–453. Springer Berlin / Heidelberg, 2008.

[4] Andréa Loyer, Jean-Jacques Sinou, Olivier Chiello, and Xavier Lorang. Model reduction strategy for railway disc brake squeal prediction. In *6th European Conference on Braking*, 2010.

[5] Andréa Loyer, Jean-Jacques Sinou, Olivier Chiello, and Xavier Lorang. Étude du crissement d'un frein à disque ferroviaire, réduction de modèle en dynamiques transitoire et stationnaire, 10e Colloque National en Calcul des Structures, 9-13 Mai 2011.

[6] Guillaume Vermot des Roches. *Frequency and time simulation of squeal instabilities Application to the design of industrial automotive brakes*. PhD thesis, École Centrale Paris, 2010.