



HAL
open science

Diverse p63 and p73 isoforms regulate D133p53 expression through modulation of the internal TP53 promoter activity

Jean-Christophe Bourdon, Virginie Marcel, Fiona Murray-Zmijewski, Valerie Meuray, Alexandra Diot, Kenneth Fernandes Fernandes, David P Lane, Isabelle Petit, Theo Goulet de Rugy, Daniel Aberdam

► To cite this version:

Jean-Christophe Bourdon, Virginie Marcel, Fiona Murray-Zmijewski, Valerie Meuray, Alexandra Diot, et al.. Diverse p63 and p73 isoforms regulate D133p53 expression through modulation of the internal TP53 promoter activity. *Cell Death and Differentiation*, 2011, <10.1038/cdd.2011.152>. <hal-00696137>

HAL Id: hal-00696137

<https://hal.science/hal-00696137v1>

Submitted on 11 May 2012

HAL is a multi-disciplinary open access archive for the deposit and dissemination of scientific research documents, whether they are published or not. The documents may come from teaching and research institutions in France or abroad, or from public or private research centers.

L'archive ouverte pluridisciplinaire **HAL**, est destinée au dépôt et à la diffusion de documents scientifiques de niveau recherche, publiés ou non, émanant des établissements d'enseignement et de recherche français ou étrangers, des laboratoires publics ou privés.



HAL Authorization

Diverse p63 and p73 isoforms regulate Δ 133p53 expression through modulation of the internal *TP53* promoter activity

Virginie Marcel¹, Isabelle Petit², Fiona Murray-Zmijewski¹, Théo Gouillet de Ruyg¹, Kenneth Fernandes¹, Valérie Meuray¹, Alexandra Diot¹, David P. Lane^{1,3}, Daniel Aberdam² and Jean-Christophe Bourdon^{1,*}

¹Centre for Oncology and Molecular Medicine, INSERM-European Associated Laboratory, Ninewells Hospital and Medical School, Dundee, DD1 9SY, Scotland UK.

²INSERM U898, University of Nice-Sophia Antipolis, Nice, France

³p53 Laboratory (p53Lab), 8A Biomedical Grove, #06-06, Immunos, Singapore 138648, Singapore.

*Correspondence to: Centre for Oncology and Molecular Medicine, INSERM-European Associated Laboratory, Ninewells Hospital and Medical School, Dundee, DD1 9SY, Scotland UK.

mail : j.bourdon@dundee.ac.uk

tel : (44) (0) 1382 496400

fax : (44) (0) 1382 496363

Word count: 3900 words

Keywords: p53, p63, p73, Δ 133p53, isoforms, promoter activity

Running title: Regulation of Δ 133p53 expression by p53 family members

ABSTRACT

In response to stress, p53 binds and transactivates the internal *TP53* promoter thus regulating the expression of its own isoform, $\Delta 133p53\alpha$. Here, we report that, in addition to p53, at least four p63/p73 isoforms regulate $\Delta 133p53$ expression at transcriptional level: p63 β , $\Delta Np63\alpha$, $\Delta Np63\beta$ and $\Delta Np73\gamma$. This regulation occurs through direct DNA-binding to the internal *TP53* promoter as demonstrated by chromatin-IP and the use of DNA-binding mutant p63. The promoter regions involved in the p63/p73-mediated transactivation were identified using deleted, mutant and polymorphic luciferase reporter constructs. In addition, we observed that transient expression of p53 family members modulates endogenous $\Delta 133p53\alpha$ expression at both mRNA and protein levels. We also report concomitant variation of p63 and $\Delta 133p53$ expression during keratinocyte differentiation of HaCat cells and induced pluripotent stem cells (iPSC) derived from mutated p63 ectodermal dysplasia patients. Finally, proliferation assays indicated that $\Delta 133p53\alpha$ isoform regulates the anti-proliferative activities of p63 β , $\Delta Np63\alpha$, $\Delta Np63\beta$ and $\Delta Np73\gamma$. Overall, this study shows a strong interplay between p53, p63 and p73 isoforms to orchestrate cell fate outcome.

INTRODUCTION

The tumour suppressor p53 protein modulates the cell-fate outcome in response to stress by regulating apoptosis, senescence or cell cycle arrest through modulation of gene expression (1). p53 specifically binds DNA to response elements (p53REs) and coordinates transcription of numerous genes. Consistent with its key role as tumour suppressor, p53 is inactivated in almost every human cancer, either by mutation in 50% of the cases or by interaction with onco-proteins.

The *TP53* family composed of *TP53*, *TP63* and *TP73* genes, present a strong homology of structures and expression patterns (2, 3). The three genes encode several protein isoforms carrying distinct N-termini (TA or Δ forms) and C-termini (α , β , γ ...), due to the use of alternative promoters, splicing sites and translational initiation sites (4, 5). The full-length proteins (p53, p63 and p73) share a similar protein structure with a N-terminal transactivation domain (TA), a central DNA-binding domain (DBD) and a C-terminal oligomerisation domain (OD) (5, 6). Thus, p63 and p73 proteins bind also specifically DNA onto p53REs promoting thus diverse biological responses, such as apoptosis or cell cycle arrest, through modulation of gene expression (7). It has been reported that in response to DNA-damage, p53-mediated apoptosis is severely impaired in the absence of both p63 and p73, suggesting a strong interplay between p53 family members (8).

The interplay between p53 family members is not limited to transcriptional modulation of common target genes; they also regulate each other's expression and activity (7). Indeed, in response to stress, p53, p73 and Δ Np73 transactivate the promoter of Δ Np73 isoform, which in turn, inhibits the transcriptional activity and apoptosis mediated by p53 and p73, by direct competition for DNA-binding (9-13). Similar regulations have been described for *TP63*. p53, Δ Np63 and p73 γ modulate the

activity of the internal *TP63* promoter regulating Δ Np63 expression, which inhibits p53, p63 and p73 transcriptional activities (3, 7, 14-16). Therefore, the interplay between p53, p63 and p73 proteins involves a combined regulation of their own isoforms and some p53-target genes.

Recently, it has been reported that p53 regulates the transcription of Δ 133p53 isoforms, which lack the entire TA and part of the DBD domains (17, 18). p53 directly binds to p53REs located within the internal *TP53* promoter leading to an increase of Δ 133p53 mRNAs in response to stress. Those transcripts generate two different N-terminal p53 isoforms, Δ 133p53 and Δ 160p53, through the use of two alternative translational initiation sites (codons 133 or 160) (19). Human Δ 133p53 α has been shown to inhibit replicative senescence as well as p53-mediated apoptosis and G1 arrest in response to stress, without inhibiting p53-mediated G2 cell cycle arrest (17, 20). Thus, Δ 133p53 α isoform is a strong modulator of p53 suppressive functions and presents similar characteristics to Δ Np63 and Δ Np73 towards their full-length form.

The interplay between p53 isoforms and p63/p73 has never been investigated. It is thus still unknown whether p63 or p73 isoforms affect the internal *TP53* promoter activity. Here, we identify four p53 family members (p63 β , Δ Np63 α , Δ Np63 β and Δ Np73 γ) able to strongly transactivate the internal *TP53* promoter. We also report that p63, p73 and Δ 133p53 α expressions are concomitantly regulated during skin differentiation and that Δ 133p53 α modulates the anti-proliferative activities of p63 and p73 isoforms, supporting the interplay between p53 family members.

RESULTS

Transactivation of the internal *TP53* promoter by several p63 and p73 isoforms

The p53 protein, also termed p53 α , transactivates the internal *TP53* promoter (P2), through direct binding to the main p53REs (Figure 1a) (17, 18). To determine whether other p53 family members can regulate the activity of the internal *TP53* promoter, we performed luciferase assays. The p3i4-Luc construct, which expresses the *Firefly* luciferase gene driven by the internal *TP53* promoter (17), was co-transfected with vectors expressing different p53 family members. The study was conducted in two different cell lines: H1299 cells, which express *TP73* but not *TP53* and *TP63*; and MCF7 cells, which express *TP53*, *TP63* and *TP73* (Supplementary Figure 1).

We first investigated the effect of four p53 isoforms. Only p53 α strongly transactivates the internal *TP53* promoter as previously described (Supplementary Figures 2a-d) (17, 18). We then analysed the impact of six p63 isoforms (Figures 1b-c). Among TAp63 forms, p63 β significantly increased the internal *TP53* promoter activity in both H1299 and MCF7 cells (+2.7-fold and +1.7-fold, respectively). A slight increase of promoter activity was observed in presence of p63 α in MCF7 but not in H1299 cells (+1.7-fold), and by p63 γ in H1299 but not in MCF7 cells (+2.2-fold). Protein expression levels of p63 α , p63 β and p63 γ were comparable in our experimental conditions (Figure 1d, Supplementary Figure 2e), suggesting that TAp63 forms have distinct intrinsic transcriptional activities towards the internal *TP53* promoter. This was verified by normalising their transcriptional activities with their protein expression levels (Supplementary Figure 3a). As contrary to TAp63 forms, the three Δ Np63 forms significantly increased the promoter activity in the two cell lines (Figures 1b-c), the transcriptional activities of Δ Np63 α and Δ Np63 β being

stronger than the one of $\Delta\text{Np63}\gamma$. Since the three ΔNp63 forms were expressed at equivalent protein levels (Figure 1d, Supplementary Figure 2e), this suggests that $\Delta\text{Np63}\gamma$ has a reduced transcriptional activity on the internal *TP53* promoter compared to $\Delta\text{Np63}\alpha$ and $\Delta\text{Np63}\beta$ (Supplementary Figure 3a). Altogether, our data showed that $\text{p63}\beta$, $\Delta\text{Np63}\alpha$ and $\Delta\text{Np63}\beta$ have the strongest transcriptional activity on the internal *TP53* promoter.

The study was then extended to seven p73 isoforms (Figure 2). In H1299 cells, all p73 isoforms co-transfected with the pi3i4-Luc construct significantly increased the promoter activity, with different intrinsic transcriptional activities (from +1.9- to +7.3-fold) (Figure 2a). In MCF7 cells, only the β forms ($\text{p73}\beta$ and $\Delta\text{Np73}\beta$) expressed at a detectable level by western blot, did not change the internal *TP53* promoter activity (Figures 2b-c, Supplementary Figures 2f-g). In contrast, p73 , $\text{p73}\gamma$, $\text{p73}\delta$ and $\Delta\text{Np73}\alpha$ significantly induced the promoter activity (from +1.2- to +2.0-fold) (Figure 2b). However, the highest promoter activity was observed in the presence of $\Delta\text{Np73}\gamma$, in both H1299 and MCF7 cells (+7.3- and +9.7-fold, respectively) (Figures 2a-b). The expression level of $\Delta\text{Np73}\gamma$ protein was comparable to the other p73 isoforms (Figure 2c, Supplementary Figure 2f-g), indicating that, among p73 isoforms, $\Delta\text{Np73}\gamma$ isoform has one of the strongest intrinsic transcriptional activities on the internal *TP53* promoter (Supplementary Figure 3b). These results suggest that several p73 isoforms, including $\Delta\text{Np73}\gamma$, can transactivate the internal *TP53* promoter.

We finally compared the transactivation levels of each p53 family members towards the internal *TP53* and the *p21* promoters, a p53/p63/p73-target gene (7, 21). This analysis was focused on the strongest activators identified above ($\text{p53}\alpha$, $\text{p63}\beta$, $\Delta\text{Np63}\alpha$, $\Delta\text{Np63}\beta$ and $\Delta\text{Np73}\gamma$) (Figure 2d). The transactivation mediated by $\text{p53}\alpha$, $\Delta\text{Np63}\beta$ and $\Delta\text{Np73}\gamma$ showed similar levels on both the internal *TP53* and the *p21* promoters. Interestingly, $\Delta\text{Np63}\alpha$ had a significantly stronger transactivation activity

on the internal *TP53* promoter than on the *p21* promoter (+4.7-fold vs +2.1-fold, respectively). Only p63 β showed a significantly stronger transactivation activity on the *p21* promoter than on the internal *TP53* promoter (+21.9-fold vs +3.3-fold, respectively). Overall, several p53 family members transactivate both the internal *TP53* and *p21* promoters, suggesting that their transactivation can be regulated by p53 family members.

Identification of nucleotide sequences involved in the transactivation mediated by p53 family members

The regions of the internal *TP53* promoter involved in the transactivation mediated by p63 and p73 isoforms were investigated by luciferase assays using deleted versions of the pi3i4-Luc construct (Figure 3) (17). In MCF7 cells, the deleted constructs presented distinct basal luciferase activities (Figure 3b). The higher basal activities were observed for the deleted promoter constructs pi3i4-Luc(C) and (D). This indicates that the regions 1-723 and 953-1042 contain negative regulatory elements (silencers), while the region 723-953 encompassing the main p53RE (p53RE-A) contains a positive regulatory element (enhancer), as previously described (Figure 3a) (17, 18). To identify the regions involved in the p63/p73-mediated transactivation using the deleted pi3i4-Luc constructs, the promoter activity induced by p53 family members was normalised to its respective basal activity (Figures 3c-f). Co-transfection of each deleted pi3i4-Luc constructs with vectors expressing p63 β , Δ Np63 α , Δ Np63 β or Δ Np73 γ resulted in a significant induction of promoter activity in MCF7 cells as compared with an empty expression vector. For p63 β , the increased luciferase activity of pi3i4-Luc(C) is significantly different from the one of pi3i4-Luc(D) but not from the one of pi3i4-Luc(G), indicating that the deleted region 723-1042 encompassing the main p53RE-A is important for p63 β -mediated transactivation in MCF7 cells (Figure 3c). Using similar experiments for Δ Np63 α and Δ Np63 β (Figures

3d-e), we observed that induction of pi3i4-Luc(G) was significantly stronger than the one of pi3i4-Luc(D), indicating that the region 953-1042 lacking the main p53RE-A is required to induce the maximal transactivation mediated by Δ Np63 α or Δ Np63 β . Regarding Δ Np73 γ (Figure 3f), the induced luciferase activity of pi3i4-Luc(C) was significantly different from the ones of pi3i4-Luc(G) and pi3i4-Luc(D), suggesting that the region 723-953 encompassing the main p53RE-A is important for the Δ Np73 γ -mediated transactivation. These data indicated that each p63 and p73 isoforms required distinct regions to regulate the internal *TP53* promoter activity.

To determine the importance of the main p53REs located in exon 4 (p53RE-A) in the p63/p73-mediated transactivation of the internal *TP53* promoter, we performed luciferase assays in H1299 and MCF7 cells using the mutant p53RE-A1/2 pi3i4-Luc construct (Figure 4a-c) (17). As previously described, introduction of mutations in p53RE-A1 and p53RE-A2 significantly reduced the responsiveness to p53 α (-70% in H1299 and -45% in MCF7 cells), confirming that p53RE-A1 and p53RE-A2 are required for the p53 α -mediated transactivation (Figures 4b-c) (17, 18). The same result was observed for Δ Np73 γ ; the introduction of mutations in p53RE-A1/2 reduced the Δ Np73 γ -mediated transactivation by 50% in H1299 cells and by 40% in MCF7 cells. This suggests that Δ Np73 γ regulates the internal *TP53* promoter activity using the p53RE-A1/2. However, no significant difference in luciferase activity was observed in presence of p63 isoforms between wild-type and mutant p53RE-A1/2 plasmids, indicating that p53RE-A1 and p53RE-A2 have no or only limited roles in the transactivation mediated by p63 β , Δ Np63 α and Δ Np63 β .

We finally investigated the impact of two *TP53* polymorphisms on the transactivation mediated by p53 family members: *TP53* PIN3 (rs17878362), a 16bp duplication in intron 3 (non-duplicated A1 allele vs duplicated A2 allele) and *TP53* PEX4 (rs1042522, G>C), a substitution of an arginine (R) for a proline (P) at codon 72 (R72

vs 72P) (Figures 4d-e) (22, 23). We confirmed that $\Delta 133p53$ expression is under genetic control as reported by Bellini et al., since constructs carrying A2-R and A1-P haplotypes had a stronger and significantly higher intrinsic luciferase activity than the A1-R and A2-P haplotypes (Figure 4d) (24). While no difference was observed for p53 α , p63 β , $\Delta Np63\alpha$ and $\Delta Np63\beta$, these two polymorphisms modulate the $\Delta Np73\gamma$ -mediated transactivation (Figure 4e). Altogether, these observations indicate that distinct regions are involved in the p63 and p73-mediated transactivation of the internal *TP53* promoter. In particular, the regions encompassing the main p53RE-A as well as *TP53* PIN3 and PEX4 polymorphisms affect only the $\Delta Np73\gamma$ -mediated transactivation, and thus the expression levels of $\Delta 133p53$ isoforms.

Regulation of the internal *TP53* promoter through direct binding of p63 and p73 isoforms

TP63 mutations have been associated with EEC syndrome (Ectrodactyly, Ectodermal dysplasia, and Cleft lip/palate) (25). Like *TP53*, *TP63* mutations mainly occur in the DNA-binding domain impairing p63 DNA-binding and transactivation activities (26, 27). We took advantage of these physiological mutants to investigate whether the p63-mediated transactivation of the internal *TP53* promoter involved the DNA-binding domain of p63. In addition to the wild-type $\Delta Np63\alpha$ isoform, two distinct $\Delta Np63\alpha$ mutants were co-transfected with the pi3i4-Luc(A) construct in H1299 cells (Figure 5a): a conformational (C306R) and a DNA-contact mutant (R279H). As observed above, wild-type $\Delta Np63\alpha$ is a strong inducer of the internal *TP53* promoter (+4.9-fold). However, presence of a single mutation in the p63 DNA-binding domain abolished (R279H) or significantly impaired (C306R) the $\Delta Np63\alpha$ -mediated transactivation of the internal *TP53* promoter. This indicates that the DNA-binding domain of $\Delta Np63\alpha$ is required to transactivate the internal *TP53* promoter.

We then performed chromatin-immunoprecipitation (ChIP) assay to assess whether p63 and p73 isoforms regulate the transactivation of the internal *TP53* promoter through direct DNA-binding (Figure 5b-c, Supplementary Figures 4a-b). ChIPs were performed in HaCat cells, which physiologically express high levels of *TP63* and *TP73*, using the antibodies IMG-259 (specific for all p73 isoforms) and 4A4 (specific for all p63 isoforms), while non-immunised mouse IgGs were used as negative control. Immunoprecipitated DNA was then analysed by real time PCR as previously described, using a set of primers and probes specific of the internal *TP53* promoter (exon 4/intron 4 junction), of *TP53* intron 8 (negative control) and of the *p21* promoter (positive control) (17). The internal *TP53* promoter was specifically immunoprecipitated with both the 4A4 and the IMG-259 antibody in HaCat cell extracts, suggesting that p63 and p73 isoforms bind specifically the internal *TP53* promoter in standard cell culture conditions (Figures 5b-c, Supplementary Figure 4a). In addition, p73 binding to the internal *TP53* promoter was also observed in MCF7 cells (Supplementary Figure 4b). Altogether, the transactivation mediated by p63 and p73 occurs through direct binding to the internal *TP53* promoter.

Increased expression of endogenous $\Delta 133p53\alpha$ by ectopic expression of p63 isoforms

The above results suggest that p63 and p73 isoforms transactivate the internal *TP53* promoter through direct binding. To determine whether p63 and p73 isoforms modulate endogenous expression of $\Delta 133p53$, we transiently transfected p63 and p73 expression vectors in mutant p53 MDA-MB-231 cells, to avoid the regulation of endogenous $\Delta 133p53$ expression by p53 α (Figures 6a-b). Ectopic expression of p63 β , $\Delta Np63\alpha$ and $\Delta Np63\gamma$ significantly induced endogenous $\Delta 133p53$ mRNA expression, which is associated with an increase of $\Delta 133p53\alpha$ protein level. In presence of ectopic p63 isoforms, the fold-induction of $\Delta 133p53$ mRNA levels varied

from +1.5 to +1.7, this range of induction being consistent with the +1.5-fold induction previously reported in presence of ectopic p53 α expression (18). Contrary to p63 isoforms, ectopic expression of Δ Np73 γ did not affect endogenous Δ 133p53 mRNA and protein expression levels in mutant p53 MDA-MB-231 cells. Overall, we showed that p63 isoforms can modulate endogenous Δ 133p53 expression at both mRNA and protein levels.

Role of Δ 133p53 α on anti-proliferative activities of p63 and p73 isoforms

To determine whether regulation of Δ 133p53 α expression by p63/p73 isoforms may affect their biological activities independently of p53 α , we performed cell proliferation assay in p53-null H1299 cells co-transfected with Δ 133p53 α and some p63/p73 isoforms (p63 β , Δ Np63 α , Δ Np63 β and Δ Np73 γ) (Figure 6c). Cell proliferation was assessed after 15 days of neomycin selection by determining the amount of the protein-binding dye Sulforhodamine B (SRB), which is directly correlated to the number of cells. In addition, ectopic expression of p63, p73 and Δ 133p53 expression was determined by western blot (Supplementary Figures 5a-b). Ectopic expression of Δ 133p53 α significantly reduced by 30% the cell number compared with the empty expression vector, suggesting that Δ 133p53 α can inhibit cell proliferation in the absence of p53 α as previously described (Figure 6c) (18). Likewise, ectopic expression of Δ Np63 α , alone or in combination with Δ 133p53 α , decreased by 30% the cell numbers, indicating an effect of Δ Np63 α on cell proliferation independent of Δ 133p53 α .

Compared with the empty expression vector, p63 β significantly reduced the number of cells (-85%) (Figure 6c). Co-transfection of Δ 133p53 α with p63 β slightly increased the number of cells, indicating that Δ 133p53 α may inhibit the anti-proliferative activity

of p63 β . Interestingly, ectopic expression of Δ Np63 β decreased cell numbers by 80%, suggesting that Δ Np63 β has also anti-proliferative activity. Compared to ectopic expression of Δ Np63 β alone, co-transfection of Δ 133p53 α and Δ Np63 β increased the percentage of cells, indicating that Δ 133p53 α may inhibit Δ Np63 β -mediated growth suppression. Like p63 isoforms, Δ Np73 γ presented anti-proliferative activity and addition of Δ 133p53 α reduces further the cell number, suggesting that Δ 133p53 α increases Δ Np73 γ -mediated growth suppressive capacity in p53-null H1299 cells. Overall, our data indicate that Δ 133p53 α , Δ Np63 α , Δ Np63 β or Δ Np73 γ , on their own inhibit cell proliferation independently of p53 α . Interestingly, Δ 133p53 α inhibits the anti-proliferative activities of p63 β and Δ Np63 β while it enhances the anti-proliferative activity of Δ Np73 γ . Therefore, Δ 133p53 α does not systematically inhibit the activities of p63 and p73 isoforms. It rather suggests that cell proliferation is regulated by a subtle interplay between p53, p63 and p73 isoforms.

Dynamic expression of Δ 133p53 α , p63 and p73 isoforms during keratinocyte differentiation

Endogenous variation of p63 and p73 isoforms expression has been observed during keratinocyte differentiation (27, 28). We thus investigated whether physiological modulation of p63 and p73 expression may impact on Δ 133p53 α expression during keratinocyte differentiation using the HaCat *in vitro* cell model (Figures 7a-b) (29). First, HaCat cells were maintained at low calcium concentration for 10 days to allow their de-differentiation. As expected, culture of HaCat cells in low calcium concentration resulted in their de-differentiation as indicated by the loss of keratin-10 (K10) expression, a marker of squamous differentiation (Figure 7a) (29). HaCat de-differentiation was also associated with an increased expression of p63 and, interestingly, with a concomitant decrease of p73 and Δ 133p53 α expression at the

mRNA and protein levels (Figures 7a-b). After 10 days of calcium deprivation, calcium were re-introduced in the HaCat cell medium for the 3 next days to induce squamous epithelial cell differentiation. The HaCat cell differentiation, assessed by an induction of K10 expression, was associated with a repression of p63 expression concomitantly with an induction of both p73 and $\Delta 133p53\alpha$ expression at the mRNA and protein levels. Therefore, $\Delta 133p53\alpha$, p63 and p73 isoforms are differentially regulated during keratinocyte differentiation.

$\Delta Np63\alpha$ has also been shown to induce epidermal commitment of pluripotent stem cells and a single mutation found in patients affected by ectodermal dysplasia syndromes could prevented it (30, 31). Therefore, to gain further insight into the regulation of $\Delta 133p53$ expression during keratinocyte differentiation, we used induced pluripotent stem cell (iPSC) lines derived from EEC patients and control individuals. Skin fibroblasts from two patients carrying R304W or R204W single mutation in the p63 DNA-binding domain were reprogrammed into iPSC cells (Petit et al., manuscript in preparation). Control and EEC iPSC cells were induced to epidermal fate for 15 days and expression of p63, $\Delta 133p53$ and K14, a marker of keratinocytes, was monitored by real time PCR (Figure 7b). During epidermal differentiation, control and EEC iPSC cells expressed p63, although at a different level. However, EEC iPSC cells failed to differentiate into keratinocytes, illustrated by a marked reduction in K14 expression as compared to control cells. Interestingly, the strong increase of p63 mRNA level during epidermal commitment of control iPSC cells was concomitant to a significant decreased expression level of $\Delta 133p53$ mRNA. In contrast, while p63 mRNA level increased in mutant *TP63* EEC cells, however to a lesser extend than in wild-type cells, no significant change in $\Delta 133p53$ mRNA expression was observed during differentiation. Overall, it suggests that, like HaCat cells, differentiation is associated with an inverse evolution of p63 and $\Delta 133p53$ mRNA expression that is lost in mutant *TP63* cells.

DISCUSSION

The *TP53* family members regulate each other's functions and expressions through modulation of each other internal promoters (5-7, 17, 18). Based on a systematic analysis using luciferase assays in two different cell lines, H1299 and MCF7 cells, we were able to discriminate five p53 family members that strongly transactivate the internal *TP53* promoter ($> +4.5$ -fold activation): p53 α , p63 β , Δ Np63 α , Δ Np63 β and Δ Np73 γ . The transactivation activities were similar or stronger on the internal *TP53* promoter than on the *p21* promoter for most of the p53 family members with the exception of p63 β . In addition, we determined that the internal *TP53* promoter is differentially responsive to each p53 family members. It has been reported that Δ Np63 β retains the capacity to transactivate p53-target genes, while Δ Np63 α does not (3, 32, 33). In our study, we observed that both Δ Np63 α and Δ Np63 β transactivate the internal *TP53* promoter, indicating that Δ Np63 α and Δ Np63 β act in a promoter-dependent manner. Compared to Δ Np63 α and Δ Np63 β , Δ Np63 γ induced a weak transactivation level on the internal *TP53* promoter, as already observed towards the *p21* and others promoter (3, 32). Thus, p63 C-terminal domains produced by alternative splicing may confer distinct and specific transcriptional activity. In addition, we determined that the responsiveness of the internal *TP53* promoter to each p53 family members is cell-type dependent. In our conditions, p53 α , p63 β , Δ Np63 α , Δ Np63 β and Δ Np73 γ induced a higher transactivation level in p53/p63-null H1299 cells than in MCF7 cells, which express all three *TP53* family genes. This suggests that the cellular context, including the expression of p53 family

members, modulates the activities of each p53 family members on the internal *TP53* promoter.

ChIP and luciferase assays showed that the transactivation by p53 family members is mediated by their direct binding to specific and distinct DNA regions of the internal *TP53* promoter. Like p53 α , the main p53REs located at exon 4/intron 4 junction (p53RE-A) appear important but not sufficient for the Δ Np73 γ -mediated transactivation. Indeed, deletion of the promoter region 753-953 encompassing the p53RE-A1/2 and introduction of point mutations within p53RE-A1/2 significantly reduced, without abolishing, the transactivation level induced by Δ Np73 γ . Other active p53REs have been identified within the internal *TP53* promoter that may be used by Δ Np73 γ (p53RE-A3/4/5 and p53RE-B) (18). Interestingly, the Δ Np73 γ -mediated transactivation is altered by the polymorphisms *TP53* PIN3 and PEX4 (codon 72/R72P), which affect the basal activity of the internal *TP53* promoter as already described (24). This suggests a cooperation between Δ Np73 γ and another transcription factor able to bind response elements encompassing those two SNPs, such as ZNF143, known to interact with p73 protein (34), and for which several predicted binding sites are overlapping with *TP53* PIN3 (35).

For p63 β , we observed that p53RE-A1/2 are not essential, while the region 753-1042 is required to obtain the maximal p63 β -mediated transactivation. The region encompassing p53RE-A1/2 contains additional active p53REs (p53RE-A3/4/5), suggesting that to modulate the internal *TP53* promoter activity, p63 β may compete with p53 and/or p63 to bind p53RE-A3/4/5, as already proposed (7). In contrast, our results indicates that Δ Np63 α - and Δ Np63 β -mediated transactivations are independent of the main p53RE-A. Nevertheless, EEC derived mutant Δ Np63 α (R279H and C306, DNA-binding contact and conformational mutant, respectively) cannot transactivate the internal *TP53* promoter (25), suggesting that both wild-type

conformation and direct DNA contact of $\Delta Np63\alpha$ to the region 953-1042 is required to transactivate the internal *TP53* promoter. This observation is consistent with our ChIP experiments showing a direct interaction between p63 and the internal *TP53* promoter. Thus, $\Delta Np63\alpha$ can regulate the internal *TP53* promoter activity through direct binding to response elements different from the p53REs already identified (17, 18).

Our data indicate that overexpressed p53 family members can transactivate the internal *TP53* promoter independently of p53 α . Indeed, ectopic expression of p63 isoforms induced $\Delta 133p53$ expression at both mRNA and protein levels in mutant p53 MDA-MB-231 cells. Unexpectedly during keratinocyte differentiation, we observed an inverse correlation between $\Delta 133p53\alpha$ and p63 expression in both HaCat and iPSC cells derived from wild-type *TP63* patients. Since no correlation was observed in iPSC derived from mutant *TP63* patients, the inverse correlation between $\Delta 133p53\alpha$ and p63 during keratinocyte is, at least in part, p63-dependent. Knowing that the ratio of p63 and p73 isoforms expression is modulated during keratinocyte differentiation and that wild-type p53 can also induce $\Delta 133p53$ expression, it is reasonable to hypothesise that the level of $\Delta 133p53\alpha$ expression results from the global expression pattern of p53 family members. Altogether and in agreement with previous reports focused on p53 α , our data illustrate the existence of a strong interplay between p53, p63 and p73 isoforms to regulate the expression of $\Delta 133p53\alpha$ and orchestrate cell-fate outcome in response to stress and in cell differentiation (17, 20, 36, 37). Further studies will allow clarifying the role of each p53 family members in the orchestration of an integrated cellular response.

MATERIALS AND METHODS

Plasmids

Activity of the internal *TP53* promoter was analyzed using a luciferase reporter assay (17). A large *TP53* fragment (+11523 to +13076bp – accession no. X54156, NCBI) was cloned into pGL3-basic plasmid upstream of the *Firefly* luciferase gene (pi3i4-Luc) (Figure 1a, dotted box). The p21-luciferase reporter assay was used as a positive control (38). The empty pGL3-basic plasmid was used to normalize the results between the independent experiments and the plasmid expressing the *Renilla* luciferase gene was used as an internal control.

Three deleted constructs were derived from the full-length pi3i4-Luc (termed A) (Figure 3a): pi3i4-Luc(C), which retains a DNA fragment from nucleotides 723 to 1555 (where 1 corresponds to nucleotide +11523 - accession no. X54156, NCBI); pi3i4-Luc(G) (953-1555); and pi3i4-Luc(D) (1042-1555) (17). Point mutations were introduced by site-directed mutagenesis in p53RE-A (WTp53REs or MTp53RE-A1/2) (Figure 4a) (17, 18). Four polymorphic versions of pi3i4-Luc were constructed to mimic the combination of two *TP53* polymorphisms, *TP53* PIN3 (non-duplicated A1 allele vs 16bp-duplicated A2 allele) and *TP53* PEX4 (arginine (R) vs proline (P) at codon 72): pi3i4-Luc(A1-R), corresponding to pi3i4-Luc WTp53REs; pi3i4-Luc(A1-P); pi3i4-Luc(A2-R) and pi3i4-Luc(A2-P) (22, 23).

The cDNAs encoded by *TP53* family members were cloned into pcDNA3 expressing vector. The pcDNA3-Empty vector was used as a negative control. The missense mutant Δ Np63 α were kindly provided by L. Guerrini (Milan, Italy).

Cell lines and differentiation protocols

The human H1299, MCF7, MDA-MB-231 and HaCat cell lines were maintained at 37°C in DMEM medium supplemented by 10% foetal calf serum and 0.5% gentamycin (except HaCat cells), under 5% CO₂ atmosphere. HaCat cells, kindly provided by C. Pourreyron (Dundee, UK), were maintained in low or high calcium concentration to induce differentiation, as previously described (29). Skin fibroblasts from two EEC patients carrying R304W and R204W mutations in *TP63* and one healthy control were reprogrammed into iPSC by lentivirus-mediated overexpression of Oct3/4, Sox2, Klf4 and c-myc. Protocol for epidermal differentiation was adapted from Aberdam et al. and Guenou et al. (Petit et al., manuscript in preparation) (39, 40).

Luciferase assays

Twenty-four hours before transfection, 3.10⁴ H1299 and MCF7 cells were seeded in 24-well plates. Co-transfections were performed using Fugene reagent (*Roche*) as described by the manufacturer, to introduce 500ng of Firefly luciferase construct, 50ng of Renilla luciferase plasmid and 200ng of pcDNA3 expressing vector. Each transfection was performed in triplicate. Cells were harvested 24 hours post-transfection to perform luciferase assays using the Dual-Luciferase Reporter Assay System (*Promega*) as described by the supplier.

Western blots

Proteins were extracted by scrapping and syringing cells in 1X NuPAGE LDS buffer (*Invitrogen*) and were separated on pre-cast 10% NuPAGE gels (*Invitrogen*). Several antibodies have been used: DO-1 (anti-p53); SAPU (anti-p53, all isoforms); 4A4 (anti-p63, all isoforms) (*Imgenex* IM-80212); 259A (anti-p73, all isoforms) (*Imgenex*

IM-259A); 4B2 (anti-Hdm2); K10 (anti-cytokeratin 10) (*Abcam* ab76318). The Ku80 or actin monoclonal antibodies were used as loading controls. Amount of protein was determined by densitometry using ImageJ software (NIH).

Chromatin immunoprecipitation (ChIP)

Cells were seeded in 15-cm plate ($2 \cdot 10^6$) and fixed with 1% formaldehyde 24hrs after seeding, scraped and washed using 1X PBS. Immunoprecipitation (IP) was carried out as previously described using Dynabeads and different antibodies: non-immunized mouse IgG (negative control), 4A4 and IMG-249. Immunoprecipitated DNA was analysed by real time PCR (17). Of note, IP buffers used to immunoprecipitated 4A4 antibodies were used at pH8.

Real time PCR

Twenty-four hours before transfection, $5 \cdot 10^4$ MDA-MB-231 cells were seeded in 6-well plates. Transfections were performed using Fugene reagent (*Roche*) to introduce $1 \mu\text{g}$ of p63 or p73 pcDNA3 expressing vector. Cells were harvested 72 hours post-transfection to validate p63/p73 isoforms expression by western blot and to extract total RNAs using the RNeasy Mini Kit (Qiagen). Reverse transcription (RT) was performed on $1 \mu\text{g}$ of total RNAs using the SuperScriptII (Invitrogen) and quantification of $\Delta 133\text{p}53$, p63 and K14 mRNA levels was carried out by real time PCR on MX3000P apparatus (Stratagene).

Proliferation assays

Proliferation assays were performed in $5 \cdot 10^3$ H1299 cells, seeded in 6-well plates 24 hours before transfection. Fugene reagent (*Roche*) was used to introduce $1 \mu\text{g}$ of

each p53/p63/p73 pcDNA3 expressing vectors completed by 1µg of pcDNA3-Empty vector when required. Treatment for 14 days with 2mg/ml G418 (*Sigma*) allowed the selection of transfected cells, which were fixed by addition of methanol and stained by 0.4% sulforhodamine B (SRB) solution. Bound stain was solubilised by 10mM TrisBase and quantified by spectroscopy at 515nm.

Statistical analyses

Results are shown as an average of at least three independent experiments and error bars correspond to standard deviation. Statistical analyses were performed using the student t-test. *: $p < 0.05$; **: $p < 0.005$; ***: $p < 0.0005$.

Conflicts of Interest

The authors declare no conflict of interest.

Acknowledgements

The plasmids expressing mutant $\Delta Np63\alpha$ were kindly provided by L. Guerrini (Milan, Italy) and the HaCat cells by C. Pourreyon (Dundee, UK). KF and JCB were supported by Cancer Research UK; VM, FMZ and AD were supported by Breast Cancer Campaign. This project was supported by Cancer Research UK (grant number: C8/A6613) to JC and by the Sixth EEC Framework Program within the EPISTEM project (LSHB-CT-2005-019067) and the Agence Nationale pour la Recherche (ANR GENOPAT 08) to DA.

REFERENCES

1. Levine AJ, Oren M. The first 30 years of p53: growing ever more complex. *Nat Rev Cancer* 2009 Oct; **9** (10): 749-758.
2. Kaghad M, Bonnet H, Yang A, Creancier L, Biscan JC, Valent A, *et al.* Monoallelically expressed gene related to p53 at 1p36, a region frequently deleted in neuroblastoma and other human cancers. *Cell* 1997 Aug 22; **90** (4): 809-819.
3. Yang A, Kaghad M, Wang Y, Gillett E, Fleming MD, Dotsch V, *et al.* p63, a p53 homolog at 3q27-29, encodes multiple products with transactivating, death-inducing, and dominant-negative activities. *Mol Cell* 1998 Sep; **2** (3): 305-316.
4. Marcel V, Hainaut P. p53 isoforms - a conspiracy to kidnap p53 tumor suppressor activity? *Cell Mol Life Sci* 2009 Feb; **66** (3): 391-406.
5. Murray-Zmijewski F, Lane DP, Bourdon JC. p53/p63/p73 isoforms: an orchestra of isoforms to harmonise cell differentiation and response to stress. *Cell Death Differ*; 2006. p. 962-972.
6. Melino G. p63 is a suppressor of tumorigenesis and metastasis interacting with mutant p53. *Cell Death Differ* 2011 Jul 15.
7. Pietsch EC, Sykes SM, McMahon SB, Murphy ME. The p53 family and programmed cell death. *Oncogene* 2008 Oct 27; **27** (50): 6507-6521.
8. Flores ER, Tsai KY, Crowley D, Sengupta S, Yang A, McKeon F, *et al.* p63 and p73 are required for p53-dependent apoptosis in response to DNA damage. *Nature* 2002 Apr 4; **416** (6880): 560-564.
9. Grob TJ, Novak U, Maise C, Barcaroli D, Luthi AU, Pirnia F, *et al.* Human delta Np73 regulates a dominant negative feedback loop for TAp73 and p53. *Cell Death Differ* 2001 Dec; **8** (12): 1213-1223.
10. Kartasheva NN, Contente A, Lenz-Stoppler C, Roth J, Dobbelstein M. p53 induces the expression of its antagonist p73 Delta N, establishing an autoregulatory feedback loop. *Oncogene* 2002 Jul 18; **21** (31): 4715-4727.
11. Nakagawa T, Takahashi M, Ozaki T, Watanabe Ki K, Todo S, Mizuguchi H, *et al.* Autoinhibitory regulation of p73 by Delta Np73 to modulate cell survival and death through a p73-specific target element within the Delta Np73 promoter. *Mol Cell Biol* 2002 Apr; **22** (8): 2575-2585.
12. Stiewe T, Theseling CC, Putzer BM. Transactivation-deficient Delta TA-p73 inhibits p53 by direct competition for DNA binding: implications for tumorigenesis. *J Biol Chem* 2002 Apr 19; **277** (16): 14177-14185.
13. Vossio S, Palesscandolo E, Pediconi N, Moretti F, Balsano C, Levrero M, *et al.* DN-p73 is activated after DNA damage in a p53-dependent manner to regulate p53-induced cell cycle arrest. *Oncogene* 2002 May 23; **21** (23): 3796-3803.

14. Harmes DC, Bresnick E, Lubin EA, Watson JK, Heim KE, Curtin JC, *et al.* Positive and negative regulation of deltaN-p63 promoter activity by p53 and deltaN-p63-alpha contributes to differential regulation of p53 target genes. *Oncogene* 2003 Oct 23; **22** (48): 7607-7616.
15. Li N, Li H, Cherukuri P, Farzan S, Harmes DC, DiRenzo J. TA-p63-gamma regulates expression of DeltaN-p63 in a manner that is sensitive to p53. *Oncogene* 2006 Apr 13; **25** (16): 2349-2359.
16. Zaika AI, Slade N, Erster SH, Sansome C, Joseph TW, Pearl M, *et al.* DeltaNp73, a dominant-negative inhibitor of wild-type p53 and TAp73, is up-regulated in human tumors. *J Exp Med* 2002 Sep 16; **196** (6): 765-780.
17. Aoubala M, Murray-Zmijewski F, Khoury MP, Fernandes K, Perrier S, Bernard H, *et al.* p53 directly transactivates Delta133p53alpha, regulating cell fate outcome in response to DNA damage. *Cell Death Differ* 2010 Aug 6.
18. Marcel V, Vijayakumar V, Fernandez-Cuesta L, Hafsi H, Sagne C, Hautefeuille A, *et al.* p53 regulates the transcription of its Delta133p53 isoform through specific response elements contained within the TP53 P2 internal promoter. *Oncogene* 2010 May 6; **29** (18): 2691-2700.
19. Marcel V, Perrier S, Aoubala M, Ageorges S, Groves MJ, Diot A, *et al.* Delta160p53 is a novel N-terminal p53 isoform encoded by Delta133p53 transcript. *FEBS Lett* 2010 Oct 13.
20. Fujita K, Mondal AM, Horikawa I, Nguyen GH, Kumamoto K, Sohn JJ, *et al.* p53 isoforms Delta133p53 and p53beta are endogenous regulators of replicative cellular senescence. *Nat Cell Biol* 2009 Sep; **11** (9): 1135-1142.
21. Perez CA, Pietenpol JA. Transcriptional programs regulated by p63 in normal epithelium and tumors. *Cell Cycle* 2007 Feb 1; **6** (3): 246-254.
22. Lazar V, Hazard F, Bertin F, Janin N, Bellet D, Bressac B. Simple sequence repeat polymorphism within the p53 gene. *Oncogene* 1993 Jun; **8** (6): 1703-1705.
23. Matlashewski GJ, Tuck S, Pim D, Lamb P, Schneider J, Crawford LV. Primary structure polymorphism at amino acid residue 72 of human p53. *Mol Cell Biol* 1987 Feb; **7** (2): 961-963.
24. Bellini I, Pitto L, Marini MG, Porcu L, Moi P, Garritano S, *et al.* DeltaN133p53 expression levels in relation to haplotypes of the TP53 internal promoter region. *Hum Mutat* 2010 Apr; **31** (4): 456-465.
25. Celli J, Duijf P, Hamel BC, Bamshad M, Kramer B, Smits AP, *et al.* Heterozygous germline mutations in the p53 homolog p63 are the cause of EEC syndrome. *Cell* 1999 Oct 15; **99** (2): 143-153.
26. Browne G, Cipollone R, Lena AM, Serra V, Zhou H, van Bokhoven H, *et al.* Differential altered stability and transcriptional activity of {Delta}Np63 mutants in distinct ectodermal dysplasias. *J Cell Sci* 2011 Jul 1; **124** (Pt 13): 2200-2207.

27. Testoni B, Mantovani R. Mechanisms of transcriptional repression of cell-cycle G2/M promoters by p63. *Nucleic Acids Res* 2006; **34** (3): 928-938.
28. De Laurenzi V, Rossi A, Terrinoni A, Barcaroli D, Levrero M, Costanzo A, *et al.* p63 and p73 transactivate differentiation gene promoters in human keratinocytes. *Biochem Biophys Res Commun* 2000 Jun 24; **273** (1): 342-346.
29. Deyrieux AF, Wilson VG. In vitro culture conditions to study keratinocyte differentiation using the HaCaT cell line. *Cytotechnology* 2007 Jun; **54** (2): 77-83.
30. Medawar A, Virolle T, Rostagno P, de la Forest-Divonne S, Gambaro K, Rouleau M, *et al.* DeltaNp63 is essential for epidermal commitment of embryonic stem cells. *PLoS One* 2008; **3** (10): e3441.
31. Rostagno P, Wolchinsky Z, Vigano AM, Shvitiel S, Zhou H, Van Bokhoven H, *et al.* Embryonic stem cells as an ectodermal cellular model of human p63-related dysplasia syndromes. *Biochem Biophys Res Commun* 2010 Apr 23; **395** (1): 131-135.
32. Ghioni P, Bolognese F, Duijf PH, Van Bokhoven H, Mantovani R, Guerrini L. Complex transcriptional effects of p63 isoforms: identification of novel activation and repression domains. *Mol Cell Biol* 2002 Dec; **22** (24): 8659-8668.
33. Helton ES, Zhu J, Chen X. The unique NH2-terminally deleted (DeltaN) residues, the PXXP motif, and the PPXY motif are required for the transcriptional activity of the DeltaN variant of p63. *J Biol Chem* 2006 Feb 3; **281** (5): 2533-2542.
34. Wakasugi T, Izumi H, Uchiumi T, Suzuki H, Arao T, Nishio K, *et al.* ZNF143 interacts with p73 and is involved in cisplatin resistance through the transcriptional regulation of DNA repair genes. *Oncogene* 2007 Aug 9; **26** (36): 5194-5203.
35. Cartharius K, Frech K, Grote K, Klocke B, Haltmeier M, Klingenhoff A, *et al.* MatInspector and beyond: promoter analysis based on transcription factor binding sites. *Bioinformatics* 2005 Jul 1; **21** (13): 2933-2942.
36. Chen J, Ng SM, Chang C, Zhang Z, Bourdon JC, Lane DP, *et al.* p53 isoform delta113p53 is a p53 target gene that antagonizes p53 apoptotic activity via BclxL activation in zebrafish. *Genes Dev* 2009 Feb 1; **23** (3): 278-290.
37. Chen J, Ruan H, Ng SM, Gao C, Soo HM, Wu W, *et al.* Loss of function of def selectively up-regulates Delta113p53 expression to arrest expansion growth of digestive organs in zebrafish. *Genes Dev* 2005 Dec 1; **19** (23): 2900-2911.
38. Bourdon JC, Fernandes K, Murray-Zmijewski F, Liu G, Diot A, Xirodimas DP, *et al.* p53 isoforms can regulate p53 transcriptional activity. *Genes Dev*; 2005. p. 2122-2137.
39. Aberdam E, Barak E, Rouleau M, de LaForest S, Berrih-Aknin S, Suter DM, *et al.* A pure population of ectodermal cells derived from human embryonic stem cells. *Stem Cells* 2008 Feb; **26** (2): 440-444.

40. Guenou H, Nissan X, Larcher F, Feteira J, Lemaitre G, Saidani M, *et al.* Human embryonic stem-cell derivatives for full reconstruction of the pluristratified epidermis: a preclinical study. *Lancet* 2009 Nov 21; **374** (9703): 1745-1753.
41. Reisman D, Balint e, Loging WT, Rotter V, Almon E. A novel transcript encoded within the 10-kb first intron of the human p53 tumor suppressor gene (D17S2179E) is induced during differentiation of myeloid leukemia cells. *Genomics* 1996 Dec 15; **38** (3): 364-370.
42. Reisman D, Greenberg M, Rotter V. Human p53 oncogene contains one promoter upstream of exon 1 and a second, stronger promoter within intron 1. *Proc Natl Acad Sci U S A* 1988 Jul; **85** (14): 5146-5150.

FIGURE LEGENDS

Figure 1. Regulation of the internal *TP53* promoter activity by p63 isoforms. **(A)** Schematic representation of the human *TP53* gene. In addition to the proximal promoter (P1) located upstream exon 1 regulating p53 and $\Delta 40$ forms, a second promoter (P2) has been described from end of intron 1 to beginning of exon 5 that regulate $\Delta 133$ and $\Delta 160$ forms expression. The main p53 response elements (p53REs) have been described at the exon 4/intron 4 junction. Dotted box: internal *TP53* promoter introduced in pi3i4-Luc construct; P*: promoter in *TP53* intron 1 identified by Reisman *et al.* that regulates the expression of an unrelated p53 transcript encoded by *TP53* intron 1 (41, 42). **(B, C)** Impact of p63 isoforms on the internal *TP53* promoter activity in H1299 (B) and in MCF7 cells (C). Luciferase assays were performed in presence of p63 isoforms using pi3i4-Luc construct. Among p63 isoforms, p63 β , Δ Np63 α and Δ Np63 β strongly increased luciferase activity. *: $p < 0.05$; **: $p < 0.005$. **(C)** Expression levels of ectopic p63 isoforms in H1299 cells analyzed by western blot. 4A4: antibody specific of all p63 isoforms; Actin: loading control.

Figure 2. Regulation of the internal *TP53* promoter activity by p73 isoforms. **(A, B)** Impact of p73 isoforms on the internal *TP53* promoter activity in H1299 (A) and in MCF7 cells (B). Luciferase assays were performed in presence of p73 isoforms using pi3i4-Luc construct. Among p73 isoforms, only Δ Np73 γ strongly induced the activity of the internal *TP53* promoter. *: $p < 0.05$; **: $p < 0.005$. **(C)** Expression levels of ectopic p73 isoforms in H1299 cells analyzed by western blot. 259A: antibody specific of all p73 isoforms; Actin: loading control. **(D)** Comparison of the transcriptional activities of p53 family members on the internal *TP53* and the *p21*

promoters. The p53 family members showing the strongest transactivation activity on the internal *TP53* promoter were used. The same range of activation was observed for p53 α , Δ Np63 α , Δ Np63 β and Δ Np73 γ on the two different promoters in H1299 cells. **: p < 0.005; ***: p < 0.0005.

Figure 3. Identification of internal *TP53* promoter regions involved in the transactivation mediated by p53 family members. **(A)** Schematic representation of the sequential deletions introduced in the full-length pi3i4-Luc(A) construct to generate three deleted pi3i4-Luc vectors (C, G, and D). Only pi3i4-Luc(A) and pi3i4-Luc(C) retain the main p53REs. Arrow: initiation site of transcription; nucleotide number 1: corresponds to nucleotide +11523 - accession no. X54156, NCBI. **(B)** Basal luciferase activity of the deleted pi3i4-Luc constructs in MCF7 cells. As compared to the entire pi3i4-Luc(A) construct, the pi3i4-Luc(C) and (D) showed a significant increase in basal luciferase activity, suggesting the presence of different regulatory elements on the internal *TP53* promoter (silencers and enhancers). **(C-E)** Regions of the internal *TP53* promoter involved in the transactivation mediated by p63 β (C), Δ Np63 β (D), Δ Np63 α (E) and Δ Np73 γ (F). The differences in basal activities have been normalized to evaluate the activation induced by p53 family members in MCF7 cells. Nucleotides 753-1042 are involved in the transactivation mediated by p63 β , 953-1042 in the one mediated by Δ Np63 α and Δ Np63 β , 723-953 in the one of Δ Np73 γ .

Figure 4. Role of *cis*-elements in the transactivation mediated by p53 family members. **(A)** Five p53 response elements (p53RE-A1 to -A5) have been identified at exon 4/intron 4 junction. In pi3i4-Luc construct, point mutations have been introduced in p53RE-A1 and -A2 to abolish their usage. WTp53REs: wild-type

sequence of p53REs; MTp53RE-A1/2: mutant sequence of p53REs; bold: p53REs; underlined: mismatch between consensus p53RE and p53REs of the internal *TP53* promoter; star: point mutations introduced by site-directed mutagenesis. **(B, C)** Impact of mutations within p53REs on the transactivation mediated by p53 family members on the internal *TP53* promoter activity in H1299 (B) and in MCF7 cells (C). Luciferase assays were performed in presence of p53 family members using pi3i4-Luc constructs carrying WTp53REs or MTp53RE-A1/2. Only p53 α and Δ Np73 γ were affected by mutations introduced in p53RE-1 and p53RE-2. *: p < 0.05; **: p < 0.005. **(D)** Impact of *TP53* polymorphisms on the basal promoter activity. Luciferase assays were performed in MCF7 cells using pi3i4-Luc construct carrying four different haplotypes mimicking haplotypes derived from *TP53* PIN3 (rs17878362 in intron 3: A1: non-duplicated; A2: 16bp duplication) and from *TP53* PEX4 (rs1042522, G>C in exon 4: R: arginine at codon 72; P: proline at codon 72). A1-R and A2-P presented the strongest intrinsic luciferase activity compared to A2-R and A1-P. **: p < 0.005. **(E)** Impact of *TP53* polymorphisms on the transactivation of the internal *TP53* promoter mediated by p53 family members. Luciferase assays were performed in MCF7 cells using the four polymorphic pi3i4-Luc constructs in presence of p53 family isoforms. Differences in basal activities have been normalized to evaluate the activation induced by p53 family isoforms. *TP53* PIN3 and PEX4 significantly affect Δ Np73 γ -mediated transactivation. * : p < 0.05.

Figure 5. Direct DNA-binding of p63 and p73 isoforms to the internal *TP53* promoter.

(A) Impact of wild-type and mutant Δ Np63 α isoforms on the internal *TP53* promoter. Luciferase assays were performed in H1299 cells using the pi3i4-Luc construct in presence of wild-type (WT) or mutant Δ Np63 α (contact mutation R279H and conformational mutation C306R). Presence of a single mutation in the DNA-binding domain of Δ Np63 α alters the Δ Np63 α -mediated transactivation on the internal *TP53*

promoter. **: $p < 0.005$; ***: $p < 0.0005$. **(B, C)** Direct binding of p63 and p73 isoforms to the internal *TP53* promoter. Chromatin-IP (ChIP) were performed in HaCat cells using the 4A4 (p63 isoforms, B) or IMG-259 (p73 isoforms, C) antibodies. Two set of primers/probe were used: one hybridizing the exon 4/intron 4 junctions specific of the internal *TP53* promoter and one hybridizing the *TP53* intron 8 used as negative control. A representative experiment was illustrated.

Figure 6. Modulation of $\Delta 133p53\alpha$ isoform expression and biological functions in response to ectopic expression of p63/p73 isoforms. **(A, B)** Variation of endogenous $\Delta 133p53$ expression in response to ectopic expression of p63/p73 isoforms. In mutant p53 MDA-MB-231 cells, introduction of p63/p73 isoforms resulted in a weak expression of $\Delta 133p53$ protein level (A) and in a significant increase of $\Delta 133p53$ mRNA level (B). Ku80: loading control; *: $p < 0.05$. **(C)** Proliferation assays in presence of p53 family members. Cell numbers have been determined on three independent experiments by measuring SRB staining by spectroscopy. Statistical analyses showed that p63 β , $\Delta Np63\beta$ and $\Delta Np73\gamma$ had growth suppressive activities, which can be modulated by introduction of $\Delta 133p53\alpha$. *: $p < 0.05$; **: $p < 0.005$; ***: $p < 0.0005$.

Figure 7. Concomitant variation of p63, p73 and $\Delta 133p53\alpha$ expression during keratinocyte differentiation. **(A, B)** Differentiation of HaCat cells by increased concentration of calcium and analysis of expression of p53 family members at both protein (A) and mRNA (B) levels. Forced differentiation of mutant p53 HaCat cells by addition of calcium decreased $\Delta Np63\alpha$ and increased p73 β expression. In parallel, an increased expression of $\Delta 133p53\alpha$ was observed at both mRNA and protein levels. d: days; Actin: loading control; *: $p < 0.05$; **: $p < 0.005$. **(C)** Epidermal

differentiation of six iPSC cell lines expressing a wild-type or a mutant *TP63* gene. Due to variability of epidermal fate efficiency between experiments, we illustrated here two representative experiments for control and mutated iPS individuals. In wild-type cells, differentiation was associated with an increased expression of p63 and a decreased expression of $\Delta 133p53$ at mRNA levels, while in mutant cells, only the increased of p63 was observed. WT: cells expressing wild-type *TP63* gene; MT: cells expressing mutant *TP63* gene (R304W or R204W).

Table I. Impact of p63 and p73 isoforms expression on the internal *TP53* promoter activity and $\Delta 133p53$ expression.

Isoforms	Transactivation activity ^a		DNA-binding activity ^b	Region of the internal <i>TP53</i> promoter involved ^c	Impact of ectopic expression on endogenous $\Delta 133p53\alpha$ expression ^d	Correlation expression with $\Delta 133p53\alpha$ during keratinocyte differentiation ^e	Growth suppression ^f			
	p21 promoter	internal <i>TP53</i> promoter	internal <i>TP53</i> promoter				alone	+ $\Delta 133p53$		
p63	α	grey	+	grey	grey	inverse	grey	grey		
	β	++	++	yes ^{C,M}	5' intron 4 (p53REs-3/-4?) ↑		+++	+++		
	γ	grey	+		grey		grey	grey	grey	
	$\Delta\alpha$	+++	++		3' intron 4 ↑		+	+		
	$\Delta\beta$	+++	+++		3' intron 4 ↑		+++	++		
	$\Delta\gamma$	grey	++		grey		grey	grey	grey	
p73	α	grey	++		yes ^C	p53REs-1/-2 =	similar	grey	grey	
	β	grey	+	grey						grey
	γ	grey	++	grey						grey
	δ	grey	+	grey						grey
	$\Delta\alpha$	grey	++	grey						grey
	$\Delta\beta$	grey	++	grey						grey
	$\Delta\gamma$	+++	+++	grey						++

^a - grey: not determined; +: 1.2-2.0 fold induction; ++: 2.0-4.5 fold-induction; +++: > 4.5 fold induction

^b - C: ChIP assays; M: use of DNA-binding mutants

^c - grey: not determined; p53REs: p53 response elements (see Figure 1a for location of p53REs)

^d - grey: not determined; ↑: increased $\Delta 133p53\alpha$ expression at both mRNA and protein levels; =: no variation of $\Delta 133p53\alpha$ expression at both mRNA and protein levels

^e - inverse or similar correlation of expression at both mRNA and protein levels

^f - grey: not determined; +: 20-40% suppression; ++: 40-75% suppression; +++: > 75% suppression

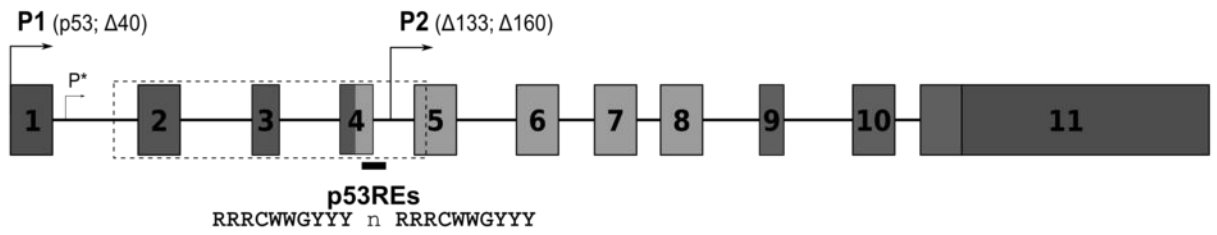
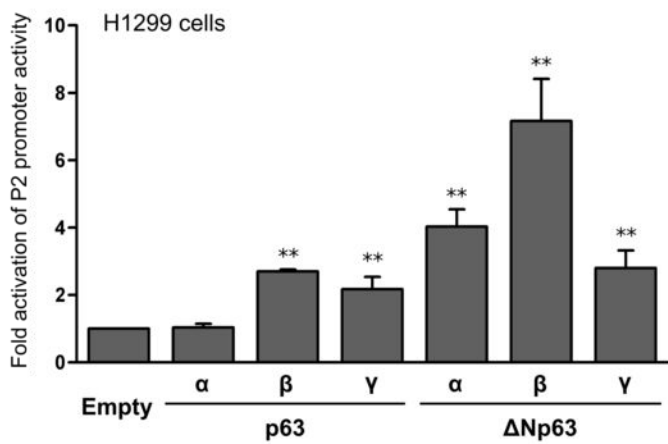
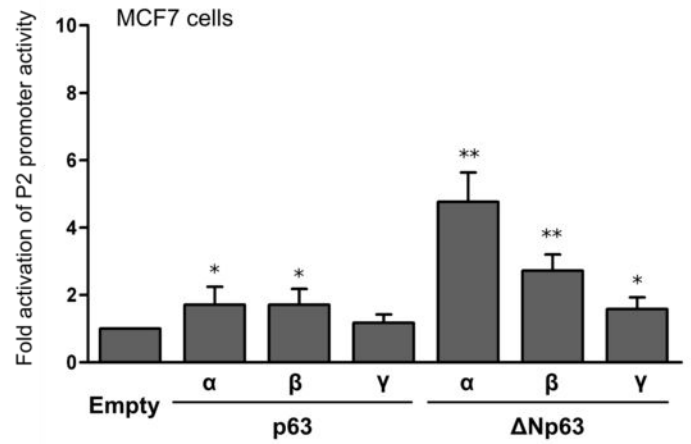
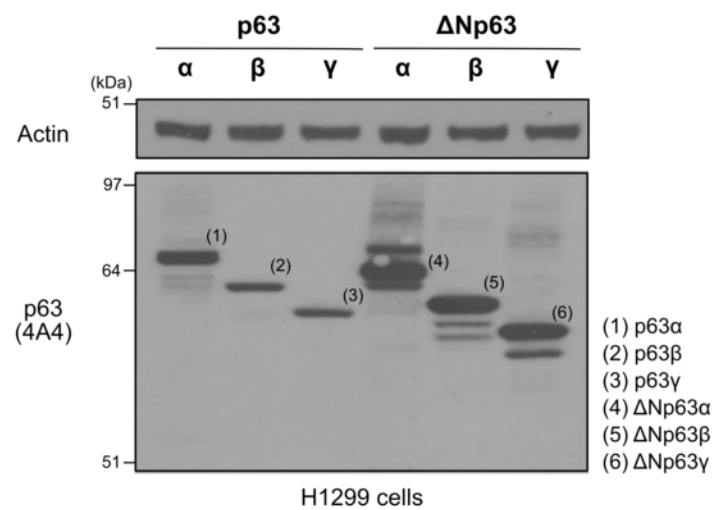
A**B****C****D**

Figure 1

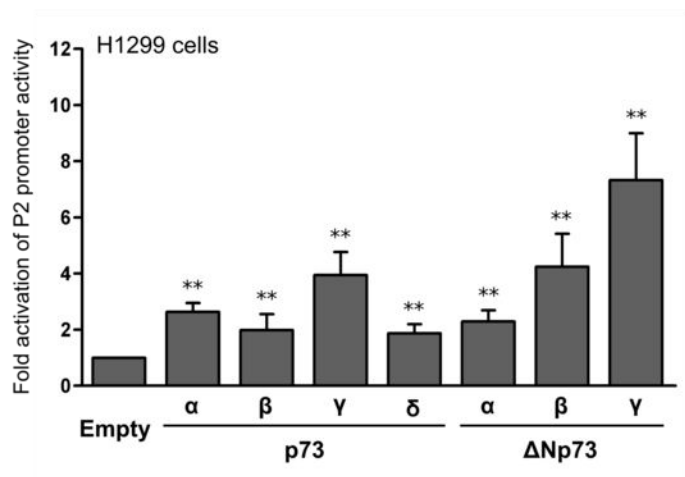
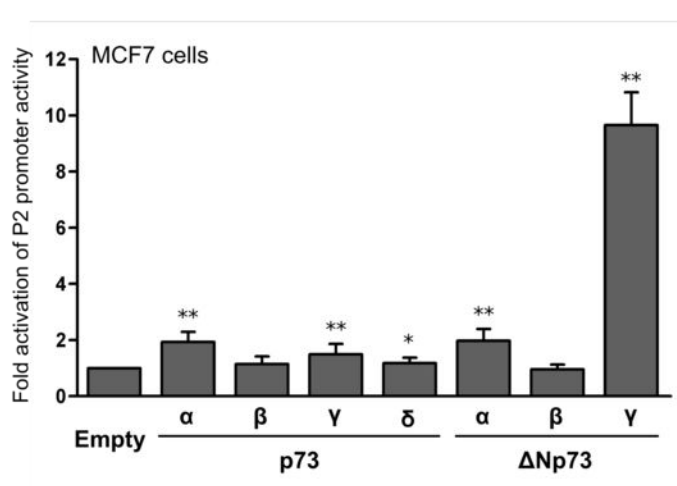
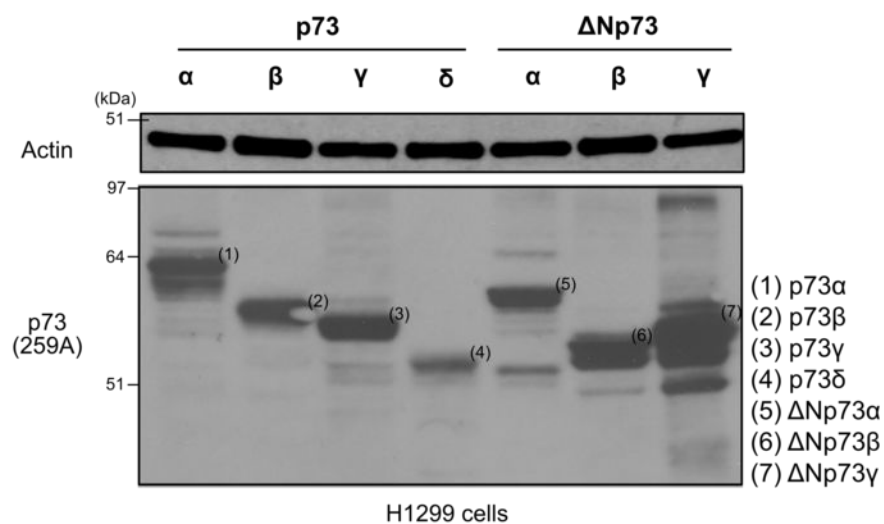
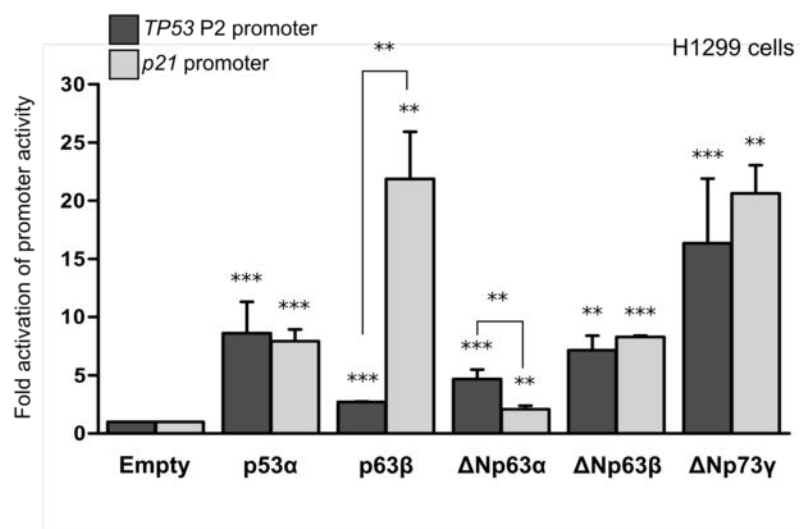
A**B****C****D**

Figure 2

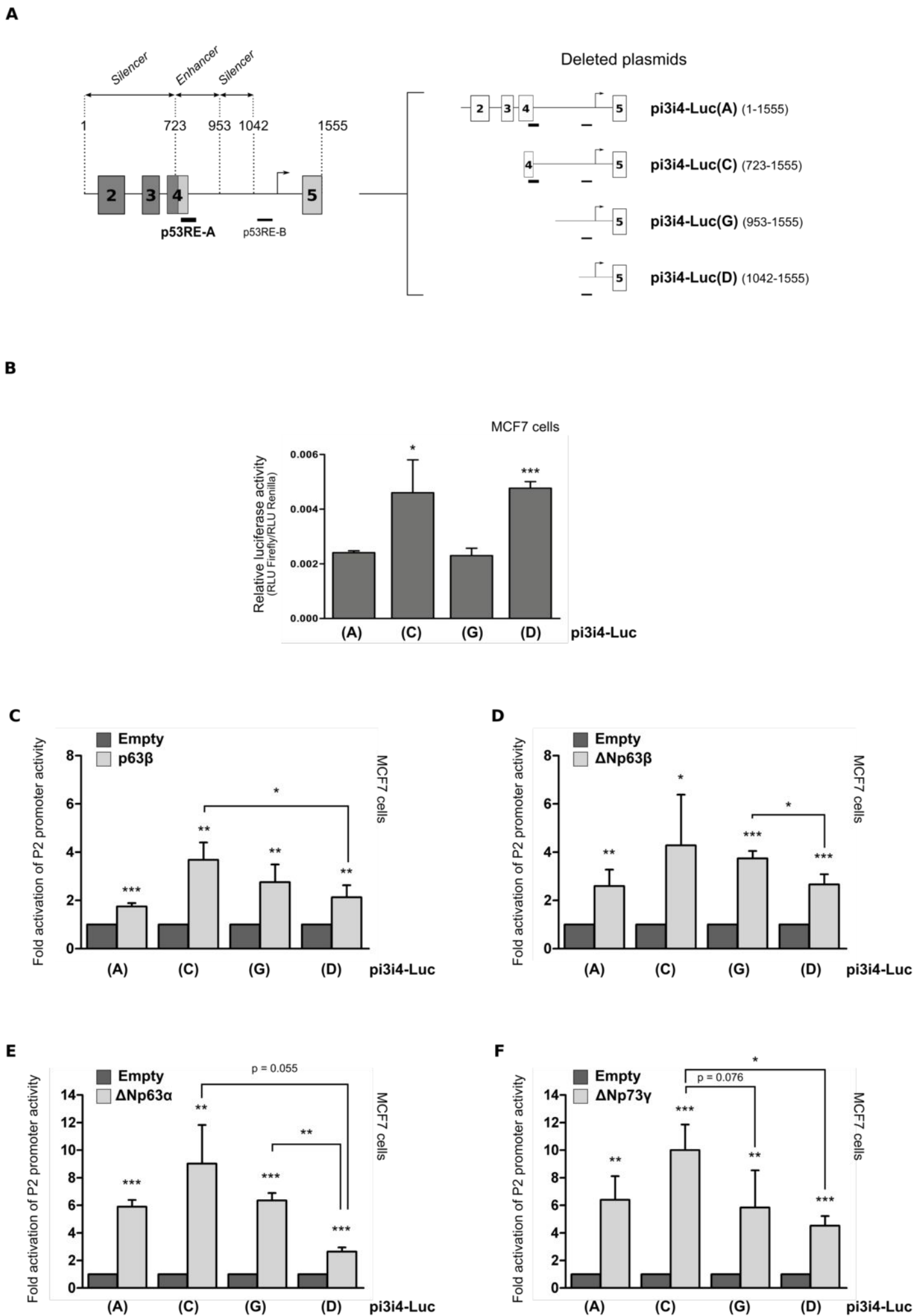
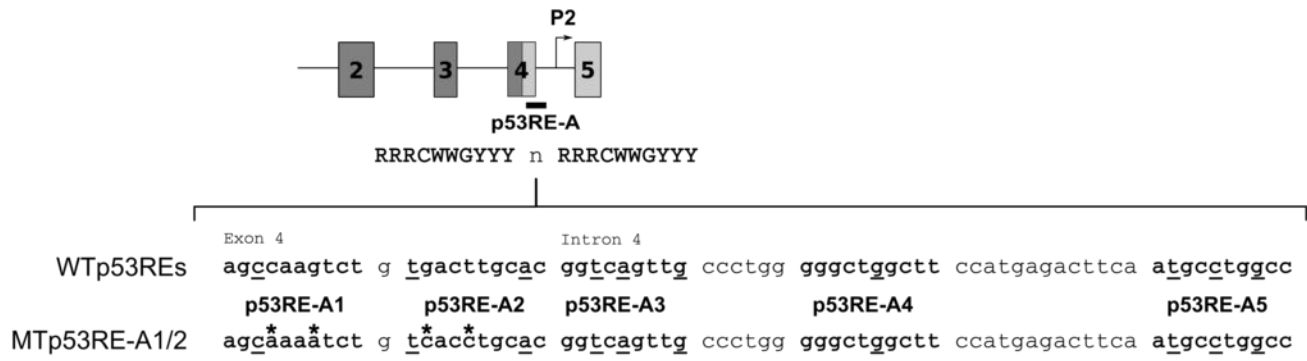
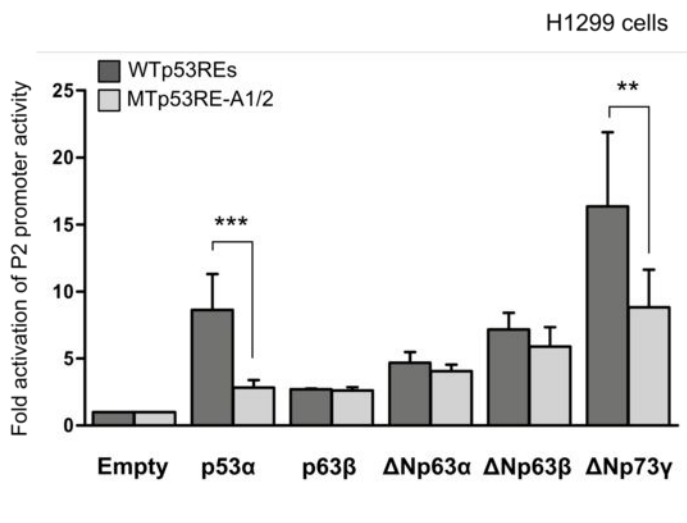


Figure 3

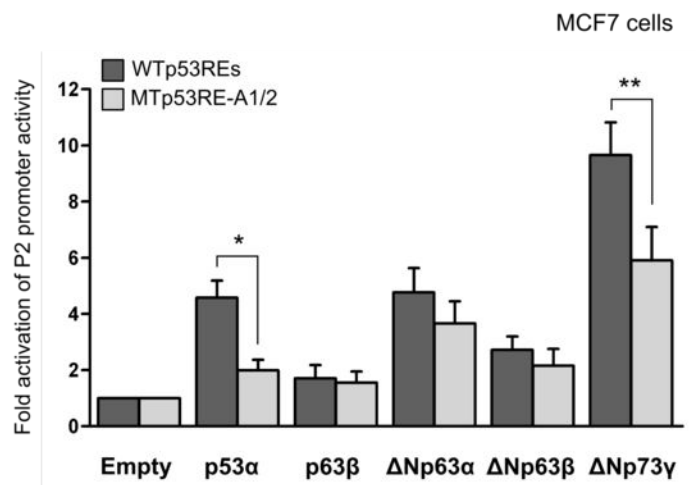
A



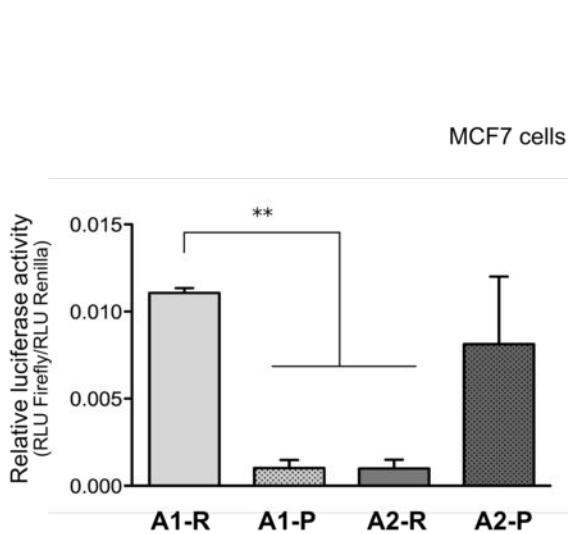
B



C



D



E

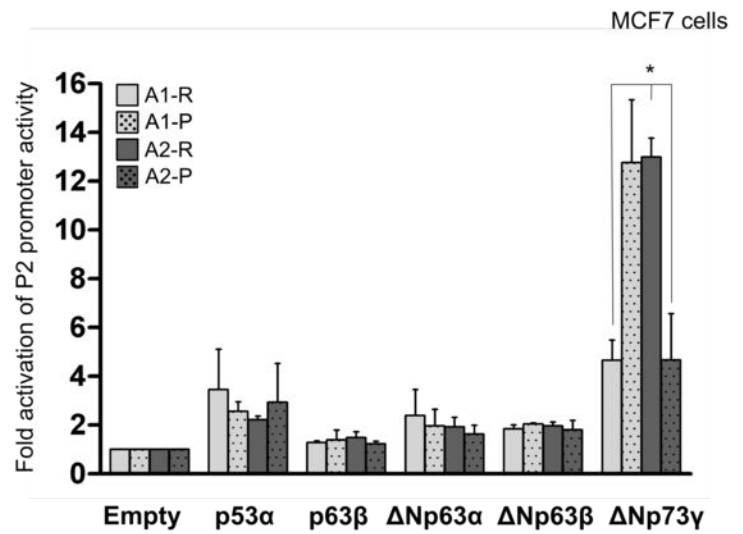
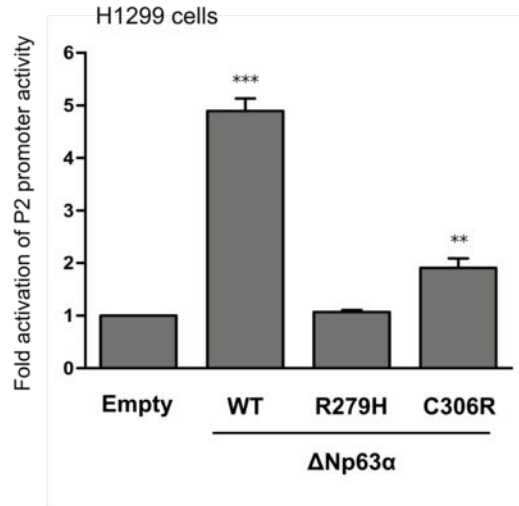
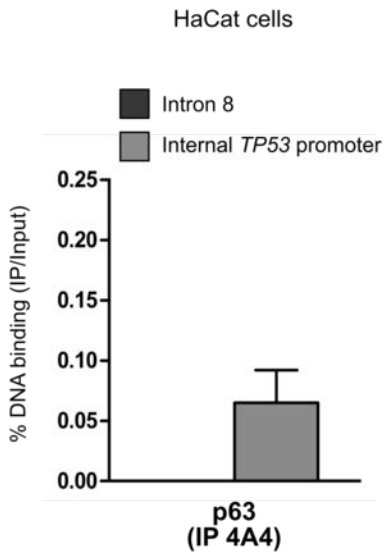


Figure 4

A



B



C

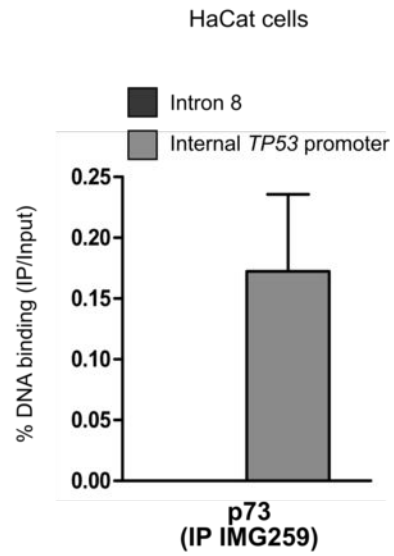
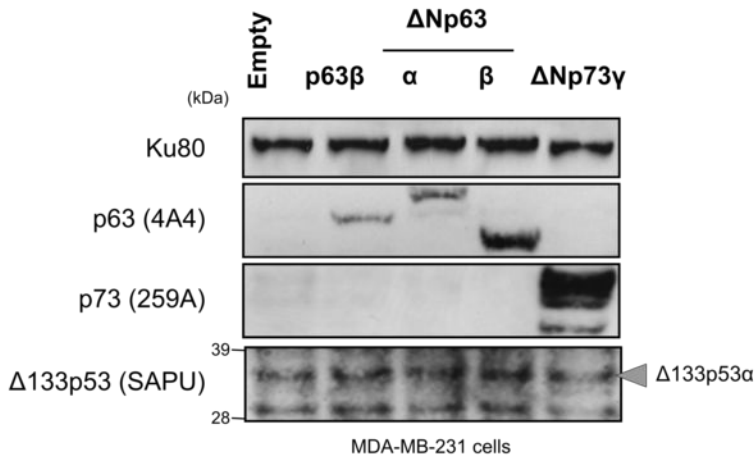
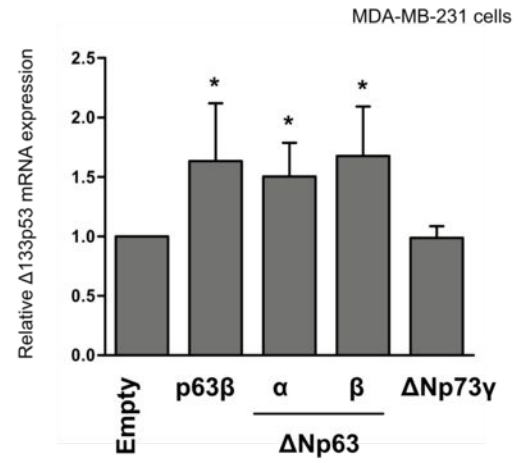
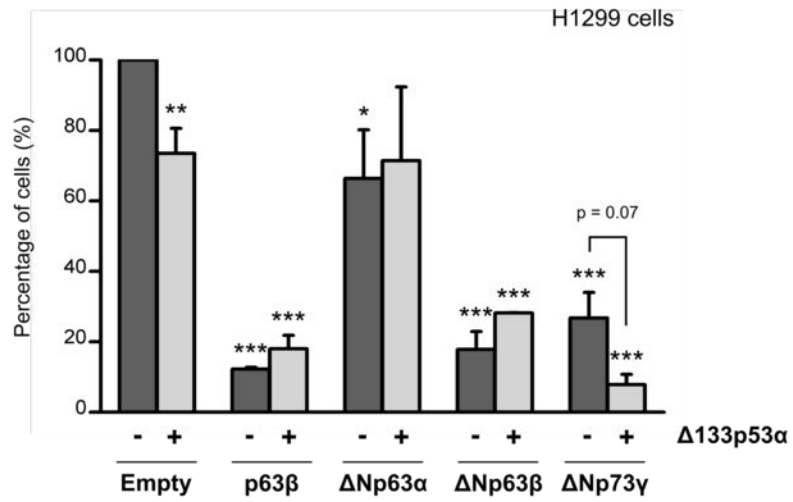


Figure 5

A**B****C**

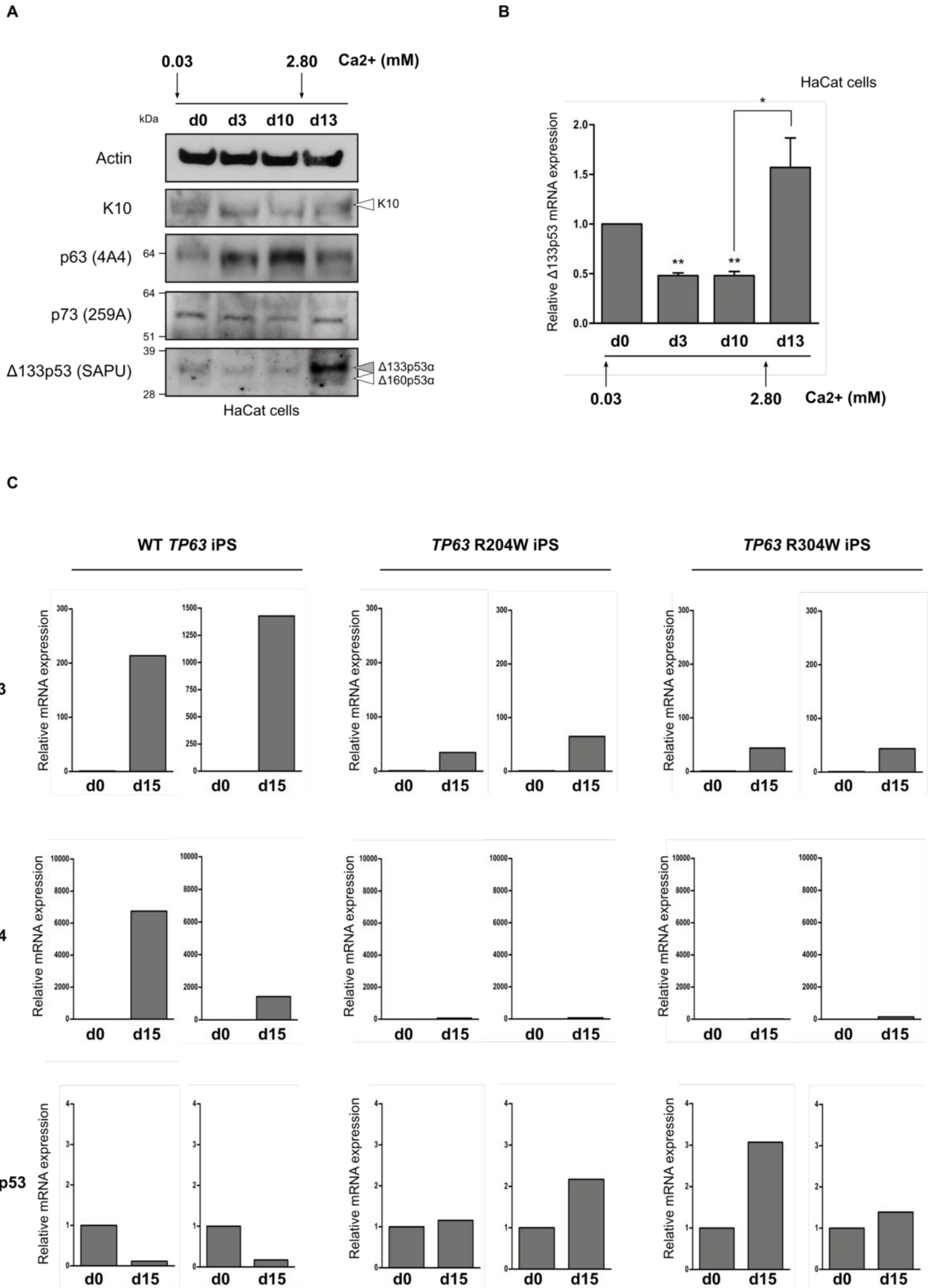


Figure 7