



HAL
open science

Effect of extractions on dynamic mechanical properties of white mulberry (*Morus alba*)

Aida Se Golpayegani, Iris Brémaud, Joseph Gril, Marie-France Thévenon,
Olivier Arnould, Kambiz Pourtahmasi

► **To cite this version:**

Aida Se Golpayegani, Iris Brémaud, Joseph Gril, Marie-France Thévenon, Olivier Arnould, et al..
Effect of extractions on dynamic mechanical properties of white mulberry (*Morus alba*). *Journal of
Wood Science*, 2012, 58, pp.153-162. 10.1007/s10086-011-1225-7 . hal-00689021

HAL Id: hal-00689021

<https://hal.science/hal-00689021v1>

Submitted on 19 Apr 2012

HAL is a multi-disciplinary open access archive for the deposit and dissemination of scientific research documents, whether they are published or not. The documents may come from teaching and research institutions in France or abroad, or from public or private research centers.

L'archive ouverte pluridisciplinaire **HAL**, est destinée au dépôt et à la diffusion de documents scientifiques de niveau recherche, publiés ou non, émanant des établissements d'enseignement et de recherche français ou étrangers, des laboratoires publics ou privés.

1 **Effect of extractions on dynamic mechanical properties of**
2 **white mulberry (*Morus alba* L.)**

3 **Original article**

4 Aida Se Golpayegani*^{1,2}, Iris Brémaud¹, Joseph Gril¹, Marie- France Thevenon²,
5 Olivier Arnould¹, Kambiz Pourtahmasi³

6 1) Laboratoire de Mécanique et Génie Civil (LMGC), Université Montpellier 2, CNRS
7 UMR5508, Place E. Bataillon, cc 048, 34095 Montpellier Cedex 5, France

8 2) Production et valorisation des bois tropicaux et méditerranéens, CIRAD PERSYST
9 Department, TA B40/16 BP 5035, 34398 Montpellier Cedex 5, France

10 3) Department of Wood and Paper Science and Technology, Faculty of Natural Resources,
11 University of Tehran, Iran

12 *Corresponding author: Aida Se Golpayegani, Phone number: +33 4 6714 (9642), Fax
13 number: +33 4 6714 (4792). Email address: aida.golpayegani@gmail.com

14 Keywords: anisotropy, damping coefficient, DMA, extractives, vibrational properties, white
15 mulberry wood (*Morus alba* L.).

16

17

18

19

20 **Abstract:**

21 Vibrational properties of wood are affected by several parameters, of which extractives can be
22 one of the most important ones. Wood for European musical instruments has been often
23 studied, but traditional Middle Eastern ones had been left unnoticed. In this study white
24 mulberry (*Morus alba* L.), the main material for long-necked lutes in Iran, was extracted by
25 five solvents of various polarities (water included). Free-free bar forced vibrations were used
26 to measure longitudinal (L) loss tangent ($\tan\delta$), storage (elastic) modulus (E') and specific
27 modulus (E'/γ) in the acoustic range. Their anisotropy between the 3 axes of orthotropy was
28 determined by DMA (dynamic mechanical analysis). Native wood had a quite low E_L'/γ but
29 its $\tan\delta$ was smaller than expected, and the anisotropy of $\tan\delta$ and E'/γ was very low. Removal
30 of extractives caused $\tan\delta$ to increase and moduli to decrease. Acetone, the most effective
31 solvent on damping despite a moderate extraction yield, increased $\tan\delta_L$ by at least 20% but
32 did not modify E'/γ as much. When used successively, its effects masked those of solvents
33 used afterwards. Anisotropy of E'/γ was nearly unchanged after extraction in methanol or hot
34 water, while $\tan\delta$ was much more increased in R than in T direction. Results suggest that in
35 white mulberry, damping is governed more by nature and localization of extractives rather
36 than by their crud abundance.

37

38

39

40

41

42 **Introduction:**

43 Wood has always been considered as a multifunctional material. Each of its versatile
44 properties makes it appropriate for a particular final use. Wood historical use in musical
45 instruments is in relation with its dynamic mechanical, or vibrational, properties, including
46 mechanical damping (loss tangent) $\tan\delta$, storage (elastic) modulus E' and specific modulus
47 E'/γ . As a quasi-orthotropic material at the macroscopic scale, wood has different properties in
48 longitudinal (L), radial (R) and tangential (T) directions (Backman and Lindberg¹; Nairn²;
49 Brémaud et al³). In the case of wood used for Western classical string instruments, it is
50 generally accepted that a low $\tan\delta$ and high E'/γ in axial direction, and a high anisotropy, are
51 convenient for obtaining a soundboard of good quality. However, few studies have addressed
52 the vibrational properties of wood used in Middle-East instruments. String instruments in Iran
53 can be traced back to 970 B.C. Long-necked lutes *Tar*, *Setar* and *Kamancheh* are specifically
54 made from white mulberry (*Morus alba* L.), which is also used for the Japanese short-necked
55 lute *Biwa* (Yoshikawa⁴).

56 Sources of variations in dynamic mechanical properties of wood include cell arrangement and
57 grain angle, microfibril angle within the cell wall, proportions of constitutive polymers, as
58 well as the presence of additional compounds (Ono and Norimoto^{5,6}; Obataya et al⁷; Noda et
59 al⁸; Bucur⁹). Although in lower quantities than cell wall constitutive polymers, extractives can
60 have a considerable effect on mechanical and damping properties of wood. Exceptionally low
61 damping of some musically important woods was somehow correlated with their extractives.
62 Extractives impact can be studied either through correlations between their amounts and
63 vibrational properties variation resulting by their removal, or by the re-injection of extracts
64 into a “neutral” wood. Methanol extraction increased the $\tan\delta$ of heartwood by 15 to 37% in
65 red cedar (*Thuja plicata*) and up to 60% in African Padauk (*Pterocarpus soyauxii*), while E'/γ

66 slightly decreased (Yano¹⁰; Brémaud et al.¹¹). Impregnation of water-soluble extractives of
67 pernambuco (*Caesalpinia echinata*) into spruce decreased $\tan\delta$ by a half (Matsunaga et al.¹²).
68 The formation of hydrogen bonds between extractives and cell wall matrix was proposed as a
69 possible cause of $\tan\delta$ reduction (Matsunaga et al.¹³). Impregnation of Sitka spruce with
70 isolated key chemical compounds from muirapiranga (*Brosimum rubescens*), a Moraceae as is
71 mulberry, decreased $\tan\delta$ by up to 25%, both in axial and radial directions. This was explained
72 by motion restriction of matrix macromolecules due to extractives entering (Minato et al.¹⁴).
73 Contrary to these studies, water-soluble extractives of Reed (*Arundo dunax* L.) increased both
74 $\tan\delta$ and E' (Obataya and Norimoto¹⁵; Obataya et al.¹⁶). Extractives can also change wood
75 equilibrium moisture content (EMC) (Hernandez¹⁷). Higher EMC induces higher $\tan\delta$ and
76 lower E'/γ (Akitsu et al.¹⁸; Obataya et al.¹⁹). The potential effect of extractives on vibrational
77 properties could come from their chemical structure, cellular location and relation with basic
78 polymers (Matsunaga et al.¹³; Brémaud et al.¹¹). Removing extractives using solvents of
79 different polarities could give a first idea about their polarity and possible cellular location.

80 Our work aims at evaluating the dynamic mechanical properties of white mulberry and
81 understanding the possible contribution of extractives. Basic properties of samples from
82 different regions of Iran were compared in a previous study (Se Golpayegani²⁰; Pourtahmasi
83 and Se Golpayegani²¹). In the present article, mulberry wood was extracted in five solvents of
84 different polarities. In order to separate the overlapping effect of various solvents, they were
85 used both as independent extracting agents, and in a successive order on the same specimens,
86 to determine changes in acoustical properties along the grain. Furthermore, the effects on the
87 anisotropy of $\tan\delta$, E' and E'/γ were also studied after extraction by the two solvents with
88 highest yields.

89

90 **Material and Methods**

91 *Material*

92 Mulberry trees were cut in Iran and kept for one month in outdoor conditions. Wood was
93 selected there by a professional instrument maker. Several 500×50×50 mm (L×R×T) rods
94 were cut from the middle of the heartwood and sent to France, in three batches within one
95 year. The 1st batch (used for powder samples and independent extractions on vibrational
96 specimens) and 2nd batch (successive extractions on vibrational specimens) came from the
97 same tree; the 3rd (specimens for DMA) came from another tree.

98 A portion of each rod was ground, the fraction passing through 40 mesh and retained on 60
99 mesh sieves was kept for powder extractions (TAPPI standard method T207_cm²²). For
100 vibrational tests, the rods were cut into approx. 200 axial specimens of dimensions
101 150×15×2 mm³ (L×R×T), from which 77 specimens were kept for extractions and controls
102 (Table 1). For DMA (Dynamic Mechanical Analysis), specimens were cut to a cross section
103 of 4×3 mm² and a length of 42-48 mm (Fig. 1). 14 specimens were prepared in each direction
104 of orthotropy leading to a total number of 42.

105 *Conditioning and physical measurements*

106 The specimens were oven dried at 60°C for 48 h. This procedure ensured that the equilibrium
107 was reached in adsorption. Residual moisture content, as compared with oven drying at
108 103°C, was around 1.36±0.49%. Specimens were then kept for three weeks in controlled
109 conditions of 20±2°C and 65±5% RH. This procedure was repeated before any mechanical
110 measurement. Specific gravity γ (both oven dried and air dried) and EMC were recorded.
111 EMC of native wood was of 7.9±0.8%.

112 Although mechanical measurements could not be run in a climatic chamber, mass change was
113 small: $-0.3 \pm 0.4\%$ for native state specimens, both during vibrational and DMA tests. For
114 treated specimens, mass change was negligible ($-0.1 \pm 0.1\%$) during vibrational tests, and less
115 than during DMA tests ($-0.6 \pm 0.7\%$).

116 ***Measurement of dynamic mechanical properties***

117 Axial dynamic mechanical properties were measured both by vibrational tests and by DMA,
118 while anisotropy was studied only by DMA.

119 **Non-contact forced bending vibrations of free-free bars**

120 A frequency scan was imposed through an electric magnet facing a tiny steel plate (15-20 mg,
121 a negligible additional weight) glued at one end of each specimen. A laser triangulation
122 sensor measured the displacement. A program developed with LabView® software
123 (Brémaud²³) monitored vibration emission and detection. Specific elastic (storage) modulus
124 (E_L'/γ) was calculated from the first resonance frequency by the Euler-Bernoulli formula and
125 elastic modulus (E_L') was obtained by multiplying E_L'/γ by specific gravity (γ). Damping
126 coefficient was measured using both bandwidth at half power in the frequency domain (or
127 quality factor) and logarithmic decrement of amplitude in the time domain after stopping the
128 vibration. Both measurements shall be equivalent to loss tangent $\tan\delta$, if $\tan\delta \ll 0.1$, which is
129 the case for air-dry wood in this temperature/frequency range. Three repetitions were made
130 for each specimen. Resonance frequencies were in the range of 200-400 Hz.

131 **DMA (Dynamic mechanical analyzer)**

132 The viscoelastic behavior of specimens was measured using a BOSE® ELF3230 DMA
133 equipped with tension/compression fatigue grips, a 22 N ($\pm 0.17\%$ maximum error) load cell

134 and a high-resolution displacement sensor (1 mm range with $\pm 0.26\%$ maximum error). The
135 specimens were fixed between two clamps with a working distance of 35 mm and tested in
136 tension along their longest direction. The tests were done in purely alternative
137 tension/compression loading controlled in displacement with an amplitude of ± 0.0175 mm
138 corresponding to a maximum tension/compression strain of $\pm 0.02\%$ (i.e., within the linear
139 viscoelastic region, see Sun et al.²⁴). Using BOSE WinTest® analysis software, E^* (norm of
140 the complex modulus), E' (storage modulus), E'' (loss modulus) and $\tan\delta$ (loss tangent) were
141 calculated. Both moduli and $\tan\delta$ were corrected for the stiffness of the whole apparatus
142 (around 1785 N/mm with a negligible viscous contribution), measured using a stiff steel
143 specimen. Frequency sweeps from 0.1 to 10 Hz were run in triplicate for each specimen,
144 native and then treated.

145 *Extraction procedures*

146 Extractions used solvents of increasing polarity: hexane (HX), dichloromethane (DM),
147 acetone (AC), methanol (ME) and hot water (HW). Most used Soxhlet extractors. Groups of
148 specimens, with similar ranges in properties, were defined after vibrational tests in native
149 state and subjected to different treatments (Table 1).

150 For extractions on powder and on solid specimens for vibrational tests, extractions were run
151 both in an independent (or parallel) and in a successive (or serial) way. Independent extraction
152 means that a sample is submitted to one extraction in a given solvent, and its properties are
153 measured before and after this single treatment. In this case, hot water extraction from
154 vibrational specimens was run (for 8h) at 70°C (not using Soxhlet). Successive extractions
155 means that a given group of specimens is submitted to extraction, first by the less polar
156 solvent (HX), then oven-dried (brief process: weighted, air-dry stabilized, weighted,

157 mechanically tested, and dried again for solid wood specimens), then extracted by the next
158 solvent (DM), and so on. In this case, a “standard” Soxhlet extraction (<95°C) was run for
159 water (complete description of conditions can be found in table 1).

160 Specimens were dried before being extracted, so that less polar solvents could not enter cell
161 walls. Control specimens underwent only physical steps (drying and stabilization) and were
162 measured in the same time and condition as extracted ones. For determination of extractive
163 content, 3 g of powder were put in a cellulose cartridge, extracted for 8 h, and their oven-dry
164 (48 h at 60°C) weight loss was measured. For solid wood, as color hardly changed during
165 extraction, duration of 12 h was chosen. Based on the yields of extractions in vibrational
166 specimens, ME and HW were applied as independent solvents on DMA specimens. For each
167 anisotropic direction, 4 specimens served as controls, 5 were extracted in ME and 5 in HW
168 (70°C, without Soxhlet). Although hemicelluloses may be partially depolymerized at
169 moderately high temperatures for water-saturated wood (Placet et al²⁵; Assor et al²⁶),
170 treatment temperatures and duration were sufficiently low to neglect such effect.

171 **Results and Discussion**

172 *Properties of native mulberry wood*

173 The specific gravity γ of the mulberry wood under study ranged from 0.45 to 0.61 (Fig. 2).
174 This was significantly lighter than wood from different regions in a previous study (Se
175 Golpayegani²⁰). The 1st batch (used for independent extractions) was significantly denser than
176 the 2nd one (used for successive extractions), although they came from the same tree. The 3rd
177 batch (used for DMA), which came from a different tree, covered a broad range, but its

178 average γ was not significantly different from the 2nd batch. Differences in density were not
179 clearly related to those in vibrational properties (Fig. 3).

180 The specific dynamic modulus in L direction of all studied batches of wood was rather low
181 (Fig. 3) and variable (11-18 GPa). Although dispersion was quite large, $\tan\delta_L$ was negatively
182 related to E'_L/γ . However, all batches generally had a lower $\tan\delta_L$ than the “standard trend”
183 from Ono and Norimoto^{5, 6}, a statistical relationship obtained on 20 softwoods and 30
184 hardwoods that can be considered as a reference. In the 1st and 3rd batches $\tan\delta_L$ was in
185 average 6% and 11% lower than “standard”, but with a higher dispersion than in 2nd batch and
186 in wood from a previous study (Se Golpayegani²⁰), for which $\tan\delta$ was always within the
187 lower range (21% and 23% lower than the standard).

188 $\tan\delta_L$ measured with DMA method was higher than that measured with free-free vibration.
189 However, it exhibited a decreasing trend against frequency, so that the difference could be
190 attributed to the higher frequency of the free-free vibration. This decrease of $\tan\delta$ with
191 frequency was also observed in other directions, as well as a slight increase of elastic moduli.
192 However, the anisotropic ratios remained constant in the observed frequency range. In the
193 following analysis, only the values measured at 10 Hz will be used. Ordering of the different
194 $\tan\delta$ in the 3 principal directions was the same as previously reported, i.e., $\tan\delta_T > \tan\delta_R >$
195 $\tan\delta_L$ (Ono and Norimoto²⁷). However, damping anisotropies between the three main
196 directions were small: $R/L \approx 1.03$, $T/L \approx 1.34$, and $T/R \approx 1.30$. These values were lower than
197 those collected from several studies by Brémaud et al.³ in which the average ratios were of 2.7
198 (R/L), 2.9 (T/L) and 1.14 (T/R) for hardwoods. Similarly, the anisotropy of E' agrees with
199 well-known relationships, i.e., $E'_L \gg E'_R \geq E'_T$, but actual values of ratios ($L/R \approx 4$, $L/T \approx 8$
200 and $R/T \approx 1.9$) were in the lower range of anisotropy compared with literature reviews (e.g.,
201 Guitard and El Amri²⁸, Nairn²). It can be noted that mulberry has a low longitudinal E'/γ and a

202 very reduced anisotropy when compared with resonance spruce that is used for top plates of
203 Western string instruments, and is closer to maple (used for back and sides) in this respect.

204 *Yield of extraction*

205 In wood powder (Fig. 4a), approximately the same cumulated amount of extractives was
206 removed when applying solvents independently or successively. In solid wood (Fig. 4b), on
207 the contrary, cumulated weight losses differed between these two extraction procedures,
208 suggesting some structural effect on the accessibility to various solvents. This was supported
209 by different extraction yields from axial, radial and tangential DMA specimens: 9, 14 and
210 18% respectively for ME.

211 Less polar solvent HX and DM, which should reach only the lumen, removed small and
212 comparable amounts (1.6% and 1.7%) when used independently on powder. Their yields were
213 much smaller in solid wood. When DM was used after HX, its yield was very low, suggesting
214 that HX had already removed most of extractives accessible to apolar solvents. Similarly, AC
215 had a smaller yield when used after HX and DM, suggesting that when used independently, it
216 also removed compounds from lumens. Although AC and ME are thought to be able to
217 solubilize similar types of compounds, ME caused the most exhaustive extraction from solid
218 wood: 6.2% when used independently. Its efficiency was even increased when used after AC
219 (7.14% from solid wood). On the contrary, in powder, HW had the highest yield (8.31%)
220 when used independently, while it had a much smaller yield on solid. This suggests that in
221 solid wood, polar extractives are more easily removed by ME than by HW, as the final
222 cumulated yields were however similar between powder and solid.

223 *Extraction effects on E_L'/γ*

224 As extractions change the mass and specific gravity (Table 2, Table 3) of wood specimens,
225 E_L'/γ values should be corrected for the contribution of extractives to γ :

$$226 \quad \left(\frac{E_L'}{\gamma} \right)_c = \left(\frac{E_L'}{\gamma} \right)_{ap} \times \frac{\gamma_{ap}}{\gamma_{ef}}, \quad (1)$$

227 where $(E_L'/\gamma)_{ap}$ and γ_{ap} are the apparent measured values, and $(E_L'/\gamma)_c$ is the corrected value
228 taking into account the specific gravity γ_{ef} after the most effective extraction (ME). $(E_L'/\gamma)_c$
229 should be more representative of an “extractives-free cell wall” modulus, and appeared 0.01
230 to 1.2 GPa higher than the apparent one (Table 2, Table 3).

231 Corrected E_L'/γ gradually decreased due to extractions. HX, DM, AC, ME and HW modified
232 E_L'/γ by 0.2%, -0.6%, -5%, -11% and -1.8% respectively after independent extractions (Fig.
233 5a). Cumulated changes (i.e. relative to native state) after successive extractions followed a
234 similar trend but with a bigger amplitude (Fig. 5b). E_L' shows a similar gradual decrease.
235 Decrease in E_L'/γ appears nearly proportional to weight loss for different solvents (Fig. 5b),
236 which suggests that extractives removed by AC, ME and HW bulked the cell wall matrix, and
237 affected elasticity independently of compounds removed by these various solvents.

238 *Changes in $\tan\delta_L$ related to weight loss*

239 Figure 6 shows relative changes in $\tan\delta_L$ caused by each solvent either used individually or
240 after others (successively). Apolar solvents (HX and DM) removed small amounts (approx.
241 1%) of extractives, probably from the lumens, resulting in small changes in $\tan\delta_L$. In
242 successive extraction, however, DM increased $\tan\delta_L$ by 14%, which might be linked to
243 previous exposition to HX. On the other hand, in another species (Padauk), DM was able to

244 slightly attain cell wall and increase $\tan\delta_L$ of approx. 20% for approx. 3% extracts removed
245 (Brémaud et al.¹¹).

246 More polar solvents (AC, ME and HW) are expected to remove higher proportions of cell
247 wall extractives, more susceptible to alter $\tan\delta_L$. However, the highest change in $\tan\delta_L$
248 resulted from AC extraction ($\approx+20\%$ independently or used after DM, $\approx+38\%$ for cumulated
249 successive effect), although its weight loss was moderate. ME and HW, despite their higher
250 yields, had smaller effects on $\tan\delta_L$ both in independent and in successive-cumulated order.
251 When used after AC, ME even reduced $\tan\delta_L$ lower than the value for the previous state (AC-
252 extracted, Fig. 6b). On the contrary, in other species, methanol extractives often have a high
253 “anti-damping” effect in wood (Yano¹⁰; Minato et al.¹⁴; Brémaud et al.¹¹). Acetone has also
254 been used recently in this kind of study, on two tropical species (Brémaud²³; Brémaud et
255 al.¹¹). It was more efficient than ME in one species, and less in the other. The contrasted
256 effects observed in mulberry could be explained by different hypotheses: (i) AC reached all
257 extractives able to alter damping, leaving only “inactive” compounds for subsequent ME or
258 HW extractions. As drying cycles could reduce $\tan\delta_L$ by $\leq 8\%$, changes in $\tan\delta_L$ after ME and
259 HW in successive order could partly reflect drying history of specimens. However, a smaller
260 effect on $\tan\delta_L$ of ME and HW than that of AC was also observed for independent extractions,
261 without cumulated drying cycles. This brings us to the second hypothesis ; (ii) Two kinds of
262 extractives compounds would co-exist in cell walls, some decreasing, and some increasing,
263 $\tan\delta_L$ in native wood. AC would have removed the first ones, so that extraction of remaining,
264 “ $\tan\delta_L$ raising”, compounds by ME and HW would decrease again the $\tan\delta_L$ of solid wood.

265 In various woods, methanol is reported to take out non-structural carbohydrates and phenolics
266 (e.g. Rowe and Conner²⁹). White mulberry has quite important content of phenolic extractives
267 (De Rosso et al.³⁰). In some woods, polyphenols can form part of the fiber cell wall matrix

268 (Kleist and Bauch³¹), while in some other woods, they may be either preferentially in vessels,
269 parenchyma walls (Dünisch et al.³²), or too much condensed to enter the cell wall substance
270 (Koch and Kleist³³). In the later hypothesis, ME might have removed some lumen deposits,
271 resulting in a lower ratio between changes in $\tan\delta_L$ and extraction yield. However, decreases
272 in $E'_{L/\gamma}$ after ME or HW suggested cell wall location. Thus, ME could have removed
273 compounds such as sugars or simple phenols, which presence will increase $\tan\delta_L$ (Obayata et
274 al.¹⁵; Sakai et al.³⁴). A decrease in $\tan\delta_L$ is also observed after ME extraction of *Thuja plicata*
275 sapwood – which should contain non-structural carbohydrates – whereas a completely
276 opposite effect is observed in the heartwood of the same species (Yano¹⁰). In mulberry,
277 extraction in HW, following ME, did not bring additional changes in $\tan\delta_L$, although it further
278 removed $\approx 4\%$ extractives. In *Caesalpinia echinata*, water soluble extractives decrease $\tan\delta_L$
279 in wood, which was first ascribed to their ability to form hydrogen bonds with cell walls
280 components (Matsunaga et al.¹²). But other extractives, without hydroxyl groups and/or
281 insoluble in water, also reduce $\tan\delta_L$ (Minato et al.¹⁴; Brémaud et al.¹¹). Finally, differences in
282 $\tan\delta_L$ might be related to changes in wood moisture content (Dunlop³⁵; Obayata et al.¹⁹;
283 Inokuchi et al.³⁶). However, changes in EMC due to independent extractions were small
284 (Table 2). In successive extractions (Table 3), with higher cumulated yields, EMC was more
285 significantly increased after ME and HW. This, however, should lead to an increase in $\tan\delta_L$,
286 instead of the observed decrease for successive use of ME and HW.

287 Therefore, the present results suggest the co-existence of some “ $\tan\delta$ – lowering” and of some
288 “ $\tan\delta$ – raising” compounds in the heartwood of white mulberry. The first ones are extractable
289 by ME but also with AC and HW, consequently independent extraction with those solvents
290 had always resulted in an increase in $\tan\delta_L$. The latter compounds, being probably
291 hydrophilic, are not extractable by HX, DM or AC. Thus a successive extraction using ME

292 and HW had reduced $\tan\delta_L$, as the “ $\tan\delta$ – lowering” had been already removed by previous
293 solvents and there were only the “ $\tan\delta$ – raising” components left. The methodology using
294 both independent and successive series of extraction might reveal similar trends in other
295 species.

296 *Changes in anisotropic properties due to extractions*

297 Figure 7 shows the variations in E'/γ and $\tan\delta$ in the three principal directions of orthotropy
298 after extractions with HW and ME or 2 drying cycles (controls). Variations in E'/γ after ME
299 extraction were similar in all three directions: -18% to -20%, although weight losses were
300 different (9%, 14% and 18% for L, R and T specimens respectively). Hot water caused both
301 lower weight losses (6-8% in L, R and T), and smaller decrease in E'/γ along L and R
302 directions, while it was similar to ME in T direction.

303 Concerning $\tan\delta$, uncertainty was high in L direction, as clamping of specimens may crush
304 wood in the softer transverse direction. Even controls showed important variations, which
305 cannot be ascribed to physico-chemical changes. However, after ME extraction, change in
306 radial $\tan\delta$ was at least twice more important than in L (DMA estimations and changes in
307 vibrational tests) and T direction (Fig. 7).

308 The quasi-isotropic effect of extractions on E'/γ is quite surprising. In previous works,
309 extractives stiffened the transverse moduli (Yano et al.³⁷; Minato et al.¹⁴), but not the axial
310 one, in which the influence of the microfibrillar reinforcement predominates (Ono and
311 Norimoto^{5, 6}; Obataya et al.⁷). However, mulberry wood has a low longitudinal E'/γ ,
312 suggesting high microfibril angle, and is characterized by a very low anisotropy in native
313 state. Effects of extractions on $\tan\delta$ were clearly different in radial and tangential directions.
314 This is interesting, as there are relatively few works on the $\tan\delta_R/\tan\delta_T$ anisotropy and sources

315 of variations. Backman and Lindberg¹ stated that, for softwood, in tensile test latewood
316 contributes mostly to the response in tangential direction while most of the strain occurs in
317 early wood in radial direction. In mulberry, a ring-porous hardwood, the response in radial
318 tension tests would more involve vessels and rays, whose cell walls are thinner, but are also
319 susceptible to contain higher proportions of extractives (Koch³⁸; Kleist and Bauch³¹; Dünisch
320 et al.³²). Thus, the very high change in $\tan\delta_R$ after ME extraction ($\approx 50\%$) could express a
321 bigger modification of rays and vessels, than of fibers.

322 **Conclusion**

323 Dynamic mechanical properties E'/γ , $\tan\delta$, and their anisotropic ratios in the 3 principal axes
324 were measured on white mulberry wood (*Morus alba* L.), a representative raw material for
325 musical instruments in Iran. They were compared before and after extractions by different
326 solvents in order to investigate extractives effects. Results could be synthesized as follows:

- 327 - Mulberry wood has a quite low E'_L/γ but its damping factor ($\tan\delta_L$) is lower than
328 expected. The anisotropy of these two properties is also much lower than average.
- 329 - Combining two methods of extractions -using each solvent as an individual agent and
330 using solvents in a successive order on a single sampling- could suggest the
331 importance of extractives nature compared to their amount.
- 332 - The highest changes in $\tan\delta_L$ were not due to the most polar solvents, with highest
333 extraction yields, but to acetone. Nevertheless, acetone did not alter E'_L/γ with the
334 same intensity, suggesting that the extracted amounts or compounds were not essential
335 for wood stiffness.

336 - The different effects of methanol extraction on $\tan\delta_L$, between individual extraction
337 and when used successively after acetone, suggest the existence of two types of $\tan\delta$
338 altering compounds in white mulberry. Some would be able to increase, some other
339 would be able to reduce the damping, and both types would be accessible by acetone
340 and methanol independently.

341 - Changes in E'/γ were nearly isotropic between the 3 principal axes of orthotropy, may
342 be due to the very low anisotropy of mulberry in native state. On the contrary, $\tan\delta$
343 was much more modified in radial than in tangential direction, suggesting different
344 responses to extractions of rays and vessels walls as compared to fibers ones.

345 It should be noted that even though extractives are found to definitely affect vibrational
346 properties of *Morus alba* L., it would be enlightening to identify the most important
347 compounds present in those extractives and how they cause changes in vibrational properties.

348

349 **References**

- 350 1. Backman AC, Lindberg KAH (2001) Differences in wood material responses for
351 radial and tangential direction as measured by dynamic mechanical thermal analysis. J
352 Mater Sci 36:3777-3783
- 353 2. Nairn JA (2007) A numerical study of the transverse modulus of wood as a function of
354 grain orientation and properties. Holzforschung 61:406-413
- 355 3. Brémaud I, Gril J, Thibaut B (2010) Anisotropy of wood vibrational properties:
356 dependence on grain angle and review of literature data. Wood Sci Technol :DOI
357 10.1007/s00226-010-0393-8
- 358 4. Yoshikawa S (2007) Acoustical classification of woods for string instruments. J
359 Acoust Soc Am 122:568–573
- 360 5. Ono T, Norimoto M (1983) Study on Young's modulus and internal friction of wood
361 in relation to the evaluation of wood for musical instruments. Jpn J Appl Phys 22:611-
362 614
- 363 6. Ono T, Norimoto M (1984) On physical criteria for the selection of wood for
364 soundboards of musical instruments. Rheol Acta 23:652-656
- 365 7. Obataya E, Ono T, Norimoto M (2000) Vibrational properties of wood along the grain.
366 J Mater Sci 35:2993-3001
- 367 8. Noda E, Aoki T, Minato K (2002) Physical and chemical characteristics of the
368 blackened portion of Japanese persimmon (*Diospyros kaki*). J Wood Sci 48: 245-249
369

- 370 9. Bucur V (2006) Acoustics of wood. Springer series in wood science. Timell, T.E.,
371 Wimmer, R. Springer-Verlag, Berlin Heidelberg New York
- 372 10. Yano H (1994) The changes in the acoustic properties of Western Red Cedar due to
373 methanol extraction. *Holzforschung* 48:491-495
- 374 11. Brémaud I, Amusant N, Minato K, Gril J, Thibaut B (2011) Effect of extractives on
375 vibrational properties of African Padauk (*Pterocarpus soyauxii* Taub.). *Wood Sci*
376 *Technol* 46:461-472
- 377 12. Matsunaga M, Minato K, Nakatsubo F (1999) Vibrational property changes of spruce
378 wood by impregnation with water-soluble extractives of pernambuco (*Guilandina*
379 *echinata* Spreng.). *J Wood Sci* 45:470-474
- 380 13. Matsunaga M, Obataya E, Minato K, Nakatsubo F (2000) Working mechanism of
381 adsorbed water on the vibrational properties of wood impregnated with extractives of
382 pernambuco (*Guilandina echinata* Spreng.). *J Wood Sci* 46:122-129
- 383 14. Minato K, Konaka Y, Brémaud I, Suzuki S, Obataya E (2010) Extractives of
384 muirapiranga (*Brosimum sp.*) and its effects on the vibrational properties of wood. *J*
385 *Wood Sci* 56:41-46
- 386 15. Obataya E, Norimoto M (1999) Acoustic properties of a reed (*Arundo donax* L.) used
387 for the vibrating plate of a clarinet. *J Acoust Soc Am* 106:1106-1110
- 388 16. Obataya E, Umezawa T, Nakatsubo F, Norimoto M (1999) The effects of water-
389 soluble extractives on the acoustic properties of reed (*Arundo donax* L.).
390 *Holzforschung* 53(1):63-67

- 391 17. Hernandez RE (2007) Moisture sorption properties of hardwoods as affected by their
392 extraneous substances, wood density, and interlocked grain. Wood Fiber Sci 39:132-
393 145
- 394 18. Akitsu H, Norimoto M, Morooka T, Rowell RM (1993) Effect of humidity on
395 vibrational properties of chemically modified wood. Wood Fiber Sci 25:250-260
- 396 19. Obataya E, Norimoto M, Gril J (1998) The effects of adsorbed water on dynamic
397 mechanical properties of wood. Polymer 39:3059-3064
- 398 20. Se Golpayegani A (2007) Evaluation of mulberry's wood (*Morus alba* L.), considering
399 its use in making Iranian musical instruments (in Farsi). Master thesis, Wood science
400 and technology, Faculty of natural resources, University of Tehran, Iran: 150
- 401 21. Pourtahmasi K, Se Golpayegani A (2008) Introducing Mulberry's wood (*Morus alba*
402 L.) used in bowl shaped musical instruments of Iran. Le bois : instrument du
403 patrimoine musical. Eds. Leconte S, Vaiedelich S. 29 May 2009 Cité de la Musique,
404 Paris.
- 405 22. Tappi standard (2008) T207_cm, T.S.m. Water solubility of wood and pulp. Technical
406 Association of the Pulp and Paper Industry, USA
- 407 23. Brémaud I (2006) Diversity of woods used **or usable** in musical instruments making.
408 (In French). PhD thesis, University of Montpellier II: 302
- 409 **24. Sun N, Das S, Frazier CH (2007) Dynamic mechanical analysis of dry wood: Linear**
410 **viscoelastic response region and effects of minor moisture changes. Holzforschung**
411 **61:28-33**

- 412 25. Placet V, Passard J, Perré P (2008) Viscoelastic properties of wood across the grain
413 measured under water-saturated conditions up to 135 °C: evidence of thermal
414 degradation. *J Mater Sci* 43:3210-3217
- 415 26. Assor C, Placet V, Chabbert B, Habrant A, Lapierre C, Pollet B, Perré P (2009)
416 Concomitant Changes in Viscoelastic Properties and Amorphous Polymers during the
417 Hydrothermal Treatment of Hardwood and Softwood. *J Agric Food Chem* 57:6830–
418 6837
- 419 27. Ono T, Norimoto M (1985) Anisotropy of dynamic Young's Modulus and internal
420 friction in wood. *Jpn J Appl Phys* 24:960-964
- 421 28. Guitard D, El Amri F (1987) Modèles prévisionnels de comportement élastique
422 tridimensionnel pour les bois feuillus et les bois résineux. *Ann Sci For* 44:335-348
- 423 29. Rowe JW, Conner A (1979) Extractives in Eastern Hardwoods-A Review. General
424 Technical report FPL18. Madison, Wisconsin, USA, Forest Products Laboratory,
425 Forest Service, U.S. Department of Agriculture:72
- 426 30. De Rosso M, Cancian D, Pnighel A, Dalla Vedova A, Flamini R (2009) Chemical
427 compounds released from five different woods used to make barrels for aging wines
428 and spirits: volatile compounds and polyphenols. *Wood Sci Technol* 43:375-385
- 429 31. Kleist G, Bauch J (2001) Cellular UV Microspectrophotometric Investigation of
430 Sapelli Heartwood (*Entandophragma cylindricum* Sprague) from Natural Provenances
431 in Africa. *Holzforschung* 55:117-122
- 432 32. Dünisch O, Richter HG, Koch G (2010) Wood properties of juvenile and mature
433 heartwood in *Robinia pseudoacacia* L. *Wood Sci Technol* 44:301-313

- 434 33. Koch G, Kleist G (2001) Application of Scanning UV Microspectrophotometry to
435 Localise Lignins and Phenolic Extractives in Plant Cell Walls. *Holzforschung* 55:563-
436 567
- 437 34. Sakai K, Matsunaga M, Minato K, Nakatsubo F (1999) Effects of impregnation of
438 simple phenolics and natural polycyclic compounds on physical properties of wood. *J*
439 *Wood Sci* 45:227-232
- 440 35. Dunlop JI (1978) Damping loss in wood at mid kilohertz frequencies. *Wood Sci*
441 *Technol* 12:49
- 442 36. Inokuchi Y, Fushitani M, Kubo T, Sato K (1999) Effects of water extractives on the
443 moisture-content dependence of vibrational properties of Bamboo. *Mokuzai gakkaishi*
444 45:77-84
- 445 37. Yano H, Kyou K, Furuta Y, Kajita H (1995) Acoustic properties of Brazilian
446 rosewood used for guitar back plate. *Mokuzai gakkaishi* 41:17-24
- 447 38. Koch G (2004) Topochemical characterization of lignins and phenolic extractives in
448 wood cell walls. *Lenzinger Berichte* 83:6-12
- 449
- 450
- 451
- 452
- 453
- 454

455 **Acknowledgments** Authors are grateful to SCAC (Service de Coopération et d'Action Culturelle) of French
456 embassy in Tehran and ISMO (Iranian Center for international research and collaboration) for supporting this
457 project.

458 **Tables**

459 Table 1: Specimens number and treatments for both independent and successive methods of extraction

Number of specimens	Solvent	Drying and stabilization condition	Number of cycles of drying and stabilization
12	Hexane (HX)	60°C for 48 h followed by 20±2°C & 65±5% RH for 3weeks	2
12	Dichloromethane (DM)		2
12	Acetone (AC)		2
12	Methanol (ME)		2
5	Hot Water (HW, 70°C)		2
12	HX/DM/AC/ME/HW (100°C)		6
12	Controls		6
15 DMA(5L, 5R, 5T)	ME		2
15 DMA(5L, 5R, 5T)	HW (70°C)		2
12 DMA(4L, 4R, 4T)	Controls		2

460

461

462

463

464

465

466

467

468

469

470

471

472

473

474 Table 2: Basic statistics for differences in properties between groups submitted to independent extractions and to
 475 one cycle of drying/re-stabilization (=control).

Treatment	EMC (%) ^d		Specific gravity γ		E'_L/γ Corrected (GPa)		$\tan\delta_L$ (10^{-3})	
	Corrected				E'_L/γ Apparent (GPa)			
	Native	Treated	Native	Treated	Native	Treated	Native	Treated ^f
Control ^e	9.2±0.5	9.2±0.2 <i>ns</i>	0.556±0.027	0.553±0.030 <i>ns</i>	15.0±2.2	15.2±2.4 <i>ns</i>	8.6±0.3	7.9±0.5 **
	8.2±0.4 (a)	8.2±0.2 (ab)	(a)	(ab)	14.0±1.6 (b)	14.2±1.6 (a)	(a)	(a)
Extracted								
HX	9.1±0.2	8.9±0.4 <i>ns</i>	0.570±0.031	0.566±0.030 **	13.5±2.0	13.7±2.0 **	10.2±0.6	9.6±0.6 **
	8.1±0.2 (a)	7.9±0.4 (a)	(a)	(b)	12.3±1.4 (a)	12.5±1.4 (a)	(b)	(bc)
DM	9.0±0.3	9.6±0.4 **	0.560±0.031	0.557±0.031 **	14.3±2.2	14.3±2.2 <i>ns</i>	9.6±1.0	9.3±0.8 *
	8.0±0.3 (a)	8.6±0.3 (c)	(a)	(b)	13.2±1.6 (ab)	13.3±1.6 (a)	(b)	(bc)
AC	9.1±0.4	9.4±0.4 *	0.567±0.026	0.550±0.025 **	14.6±1.6	13.9±1.6 **	8.7±0.4	9.8±0.6 **
	8.1±0.3 (a)	8.6±0.3 (c)	(a)	(ab)	13.3±1.1 (ab)	13.2±1.1 (a)	(a)	(c)
ME	9.2±0.4	8.7±0.2 **	0.554±0.026	0.520±0.025 **	14.4±2.2	12.9±2.0**	8.9±0.5	9.5±0.5 **
	8.2±0.4 (a)	8.3±0.3 (bc)	(a)	(a)	13.5±1.4 (ab)	12.9±1.4 (a)	(a)	(bc)
HW	9.2±0.3	9.0±0.2 <i>ns</i>	0.550±0.015	0.530±0.017 **	14.1±1.7	14.0±1.9 <i>ns</i>	8.5±0.5	8.6±0.6 <i>ns</i>
	8.2±0.3 (a)	8.3±0.1 (bc)	(a)	(ab)	13.3±1.3 (ab)	13.7±1.7 (a)	(a)	(ab)

476 “Apparent” stands for measured values; “Corrected” take into account the contribution of extractives to weight
 477 (for EMC) and specific gravity (for E'_L/γ).

478 (a, b, c): homogenous subsets in one-way ANOVA at a level $\alpha:0.05$ (=comparison between groups in a given
 479 column, based on measured values).

480 (*ns*, *, **): differences between untreated and treated properties of a given group (based on corrected values
 481 whenever applicable) in *t*-test for paired samples; **: significant at $\alpha: 0.01$, *: $\alpha: 0.05$, *ns*: not significant.

482 d) EMC relative to 103°C oven-drying. “Apparent” are measured values; “Corrected” is calculated by taking into
 483 account the total extractive content (cumulated % on powder) from 1st batch of wood (see Hernandez 2007).

484 e) “Treated” state for controls stands for values measured after one cycle of oven-drying followed by air-dry re-
 485 stabilization.

486 f) $\tan\delta_L$ are raw values, whereas $\tan\delta_L$ variations in Fig. 6 are corrected for controls.

487

488

489

490 Table 3: Basic statistics for the successive ranges in properties for the group of specimens submitted to
 491 successive extractions.

Treatment	EMC (%) ^a Corrected Apparent	Specific gravity γ	E'_{\perp}/γ Corrected (GPa) E'_{\perp}/γ Apparent (GPa)	$\tan\delta_{\perp}$ (10^{-3})
Untreated	7.0± 0.3 6.1± 0.3	0.515± 0.011	13.72± 1.47 12.99± 1.25	8.2± 0.5
HX	7.1± 0.3 <i>ns</i> 6.2± 0.2	0.512± 0.016 <i>ns</i>	13.46± 1.68 <i>ns</i> 12.82± 1.35	7.9± 0.4 **
DM	9.2± 0.2 ** 8.0± 0.2	0.515± 0.012 <i>ns</i>	13.51± 1.26 <i>ns</i> 12.78± 1.07	9.3± 0.6 **
AC	9.0± 0.4 <i>ns</i> 8.0± 0.3	0.515± 0.016 <i>ns</i>	13.53± 1.64 <i>ns</i> 12.79± 1.30	11.3± 0.8 **
ME	8.6± 0.1 ** 8.2± 0.1	0.505± 0.014 **	12.69± 1.38 ** 12.24± 1.13	10.6± 0.6 **
HW	8.8± 0.1 ** 8.8± 0.1	0.488± 0.011 **	11.85± 1.23 ** 11.84± 1.05	10.2± 0.5 *

492 “Apparent” stand for measured values; “Corrected” take into account the contribution of extractives to weight
 493 (for EMC) and specific gravity (for E'_{\perp}/γ).

494 a) EMC relative to 103°C oven-drying. “Apparent” are measured values; “Corrected” is calculated by taking into
 495 account the total extractive content (cumulated % on solid specimens) from 2nd batch of wood (see Hernandez
 496 2007).

497 (*ns*, *, **): differences between each successive extracted state in relation to the previous phase of treatment
 498 (based on corrected values whenever applicable) in *t*-test for paired samples; **: significant at α : 0.01, *: α : 0.05,
 499 *ns*: not significant.

500

501

502

503

504

505

506

507

508

509 **Figure legends**

510 Fig. 1. Cutting plan for vibrational and DMA specimens. Variations in length of DMA specimens were due to
511 limitations in raw material.

512

513 Fig. 2. Box plot of specimens **specific gravity (γ)** for the three batches of wood under study, and for previous
514 data on wood from different origins (Se Golpayegani²⁰). (a, b, c) significantly different groups (one-way
515 ANOVA).

516

517 Fig. 3. Relationship between E'_{L}/γ and $\tan\delta_{\text{L}}$ for 4 batches of native mulberry wood (N specimens: see Fig. 2).

518

519 Fig. 4: Comparison of weight loss due to independent and successive extraction in (a) powder, and (b) solid
520 (vibrational) specimens. “Successive” weight losses are relative to the previous step; “independent” and
521 “successive-cumulated” are relative to native oven-dry weight.

522

523 Fig. 5. Relationship between weight loss (%) and relative change of E'_{L}/γ (%) after (a): **independent extractions**
524 and (b): **successive extractions where changes are relative to initial state of native specimens** (i.e. cumulated
525 changes). E'_{L}/γ was corrected for contribution of extractives to γ .

526

527 Fig. 6. Relative changes (%) in $\tan\delta_{\text{L}}$ plotted against weight loss (%) for (a) independent and (b) successive
528 extractions. Changes are relative to initial state of native specimens (independent and successive-cumulated).
529 Arrows: order of successive extractions. Values of $\tan\delta_{\text{L}}$ in independent extractions are corrected for controls.

530

531 Fig. 7. Variations in mechanical properties after extractions measured by DMA at 10 Hz. Values for controls
532 were not deduced from treated ones.

533

534 **Figures**

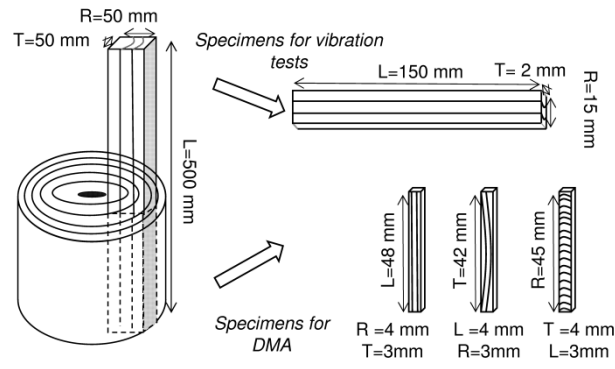

535

536

537

Fig. 1.

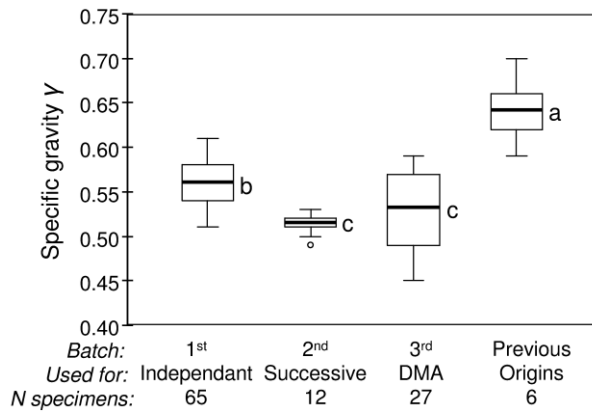

538

539

540

Fig. 2.

541

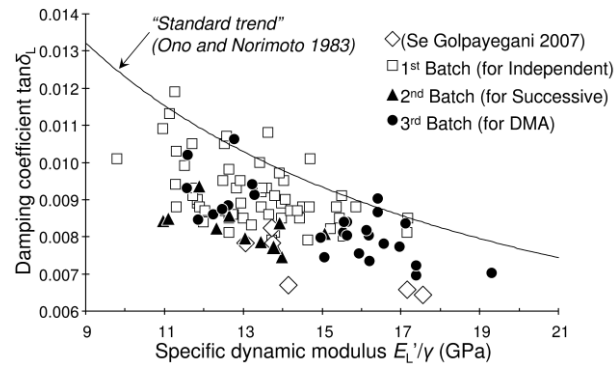

542

543

Fig. 3.

544

545

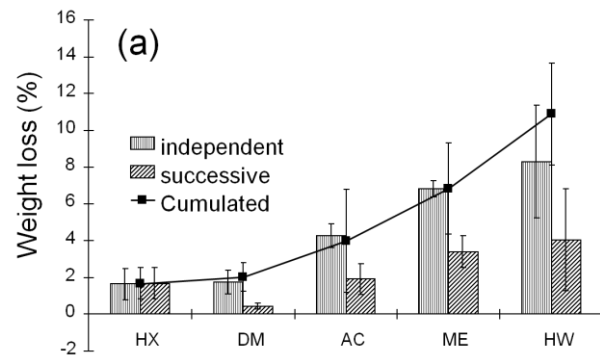

546

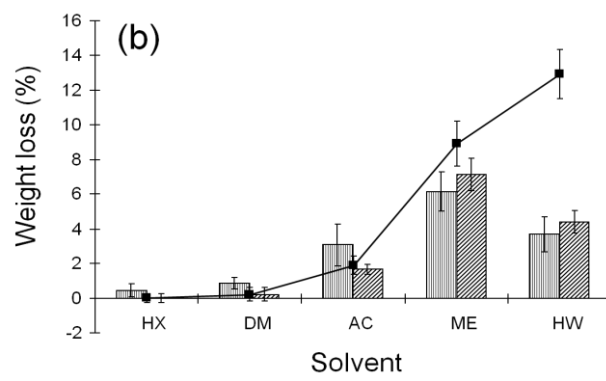

547

548

Fig. 4.

549

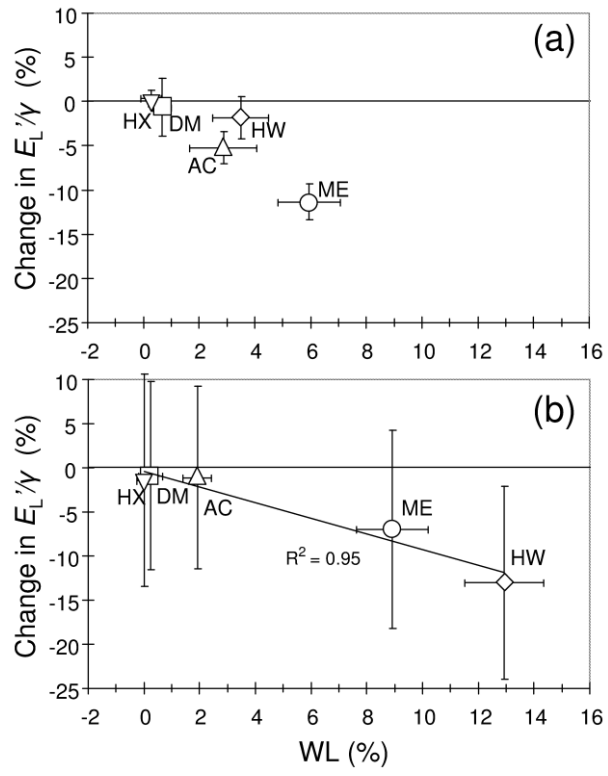

550

551

Fig. 5.

552

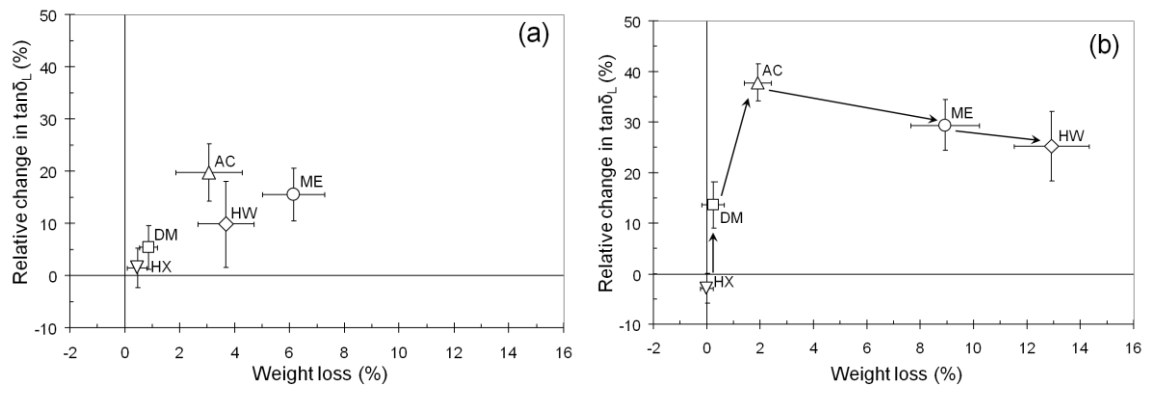

553

554

555

Fig. 6.

556

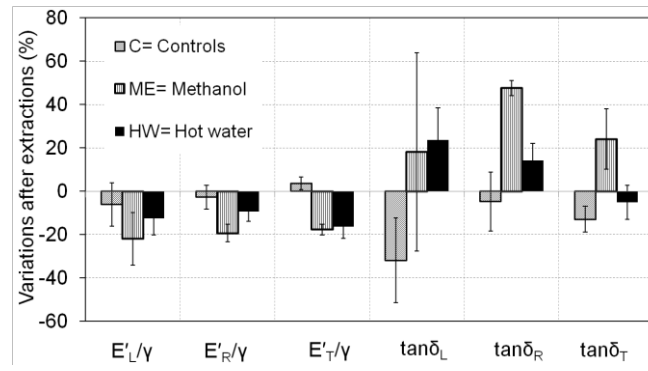

557

558

Fig. 7.