



HAL
open science

Purification of single-walled carbon nanotubes

A. Yaya, Christopher Ewels, Ph. Wagner, I. Suarez-Martinez, A. Gebramariam Tekley, L. Rosgaard Jensen

► **To cite this version:**

A. Yaya, Christopher Ewels, Ph. Wagner, I. Suarez-Martinez, A. Gebramariam Tekley, et al.. Purification of single-walled carbon nanotubes. *European Physical Journal: Applied Physics*, 2011, 54 (1), pp.10401. 10.1051/epjap/2011100482 . hal-00687327

HAL Id: hal-00687327

<https://hal.science/hal-00687327>

Submitted on 13 Apr 2012

HAL is a multi-disciplinary open access archive for the deposit and dissemination of scientific research documents, whether they are published or not. The documents may come from teaching and research institutions in France or abroad, or from public or private research centers.

L'archive ouverte pluridisciplinaire **HAL**, est destinée au dépôt et à la diffusion de documents scientifiques de niveau recherche, publiés ou non, émanant des établissements d'enseignement et de recherche français ou étrangers, des laboratoires publics ou privés.

PURIFICATION OF SINGLE-WALLED CARBON NANOTUBES

Abu Yaya, Christopher Ewels¹, Philipp Wagner,
IMN, CNRS UMR6502, 2 Rue de la Houssiniere, BP 32229, 44322 Nantes, France

Irene Suarez-Martinez
Nanochemistry Research Institute, Curtin University of Technology, GPO Bos U1987, Perth 6845, Western Australia

Abraham Gebramariam Tekley
Chemistry Department, Science Faculty, Hawassa University, P. O. Box 5, Addis Ababa, Ethiopia.

Lars Rosgaard Jensen
Department of Mechanical and Manufacturing Engineering, Aalborg University, Pontoppidanstraede 105, 9220 Aalborg East, Denmark

Abstract

We present a study of purification of single-walled carbon nanotubes (SWCNTs) using different oxidation temperatures and chemical treatments. We have developed a simple two annealing-steps procedure resulting in high nanotube purity with minimal sample loss. The process involves annealing the SWCNTs at 300°C for 2 hours with subsequent reflux in 6M HCl at 130°C, followed by further annealing at 350°C for 1 hour with reflux in 6M HCl at 130°C. The process results in effective removal of carbon impurities and metal particles which are associated with SWNTs production. The process is less time consuming (complete in 4.5 hours) than conventional acid purification methods which require over 5 hours, and less destructive than conventional methods with a yield of 26%. SWCNT purity was assessed using Raman spectroscopy, thermogravimetry and scanning electron microscopy coupled with energy-dispersive X-ray spectroscopy

Introduction

The landmark paper by S. Iijima in 1993[1] showing single-walled carbon nanotubes (SWCNTs) marked a new beginning for a wide range of research in the field of nanotechnology due to their potential for various applications such as electronic devices, nanocomposites, supercapacitors [2-3] and secondary batteries [4-5]. Common production methods for these versatile materials is by chemical vapour deposition [6], arc-discharge[7-8] and laser vaporisation [9], in the presence of a metal catalyst. Both of these production methods result in a final product containing impurities, and since high purity nanotubes are essential for final applications in, e.g. electronics, a purification process has to be employed.

Several approaches have been developed for purifying SWNTs, but often with little success or low yield in the final samples. Techniques such as gas phase or thermal annealing in air or oxygen has been used [10-12] in order to remove amorphous carbons and other carbon nanoparticles such as fullerenes that are found in SWNT soot. In addition, liquid-phase reactions in various acids or corrosive solvents [13-18] have been used to remove the metal catalysts required from the synthesis of SWNTs. Other purification techniques include ultrasonication,

¹ Corresponding Author : chris.ewels@cnrs-immn.fr

centrifugation, and filtration [19-20]. The above mentioned techniques are rarely used exclusively to purify the SWNTs, and instead are more common in combination.

Ebbesen *et al.* in 1994 purified nanotubes produced by the arc-discharge method, using oxidizing gases to selectively attack the nanotubes caps [10]. This approach relies on the fact that nanoparticles containing defect-rich structures oxidize more easily than perfect nanotubes. Ivana Chiang *et al.* purified SWNTs produced by laser vaporisation by treating the SWNTs in nitric acid, with the aim of dissolving the metal catalyst [11]. This was then followed by two oxidation steps, first at 300° C and at 500° C using an HCl extraction step after each oxidation. Moon *et al.* [21] thermally annealed SWNT powder at 470° C in air for 50 mins, followed by treatment with HCl for 24 hours. This resulted in a final reported yield of 25 wt % compared to the initial product. Chen *et al.* [22] combined a purification process consisting of bromination and subsequent selective oxidation with oxygen at 530° C for 3 days with a reported purity of the final product of 75 wt %. Zimmerman *et al.* reported a purity of 90 wt % from their work, using chlorine water and hydrogen chloride gas mixtures to remove amorphous and spherical carbon particles with or without metal catalyst inside [23].

Oxidation methods can destroy the nanotubes along with the impurities, which was attributed to the metal catalyst present in the as-produced SWNTs [24], since in the presence of the oxidizing gases the metal particles catalyse low temperature oxidation of carbons. Other non-destructive procedures via organic functionalization [25] have been developed which render the SWNTs more soluble than impurities by attaching functional groups to the nanotubes, allowing separation by filtration or chromatography [26]. However the functional moiety attached to the tubes then needs to be removed.

In this paper, we examine different purification procedures for the removal of carbon nanoparticles and metal catalyst in SWNTs samples. We propose an optimal procedure for cleaning SWNTs consisting of a two annealing step process with high final purity and minimal loss of SWNTs

Method

The as-prepared SWNTs were arc-discharge produced and supplied by Carbolex Inc. According to the supplier's information, the purity of the sample was 50-70vol% [27]. The average nanotube diameter was 1.4nm and typically grouped in bundles of about ~20nm in diameter. Impurities include approximately 35wt% residual catalyst (Ni, Y) and amorphous carbon on the outer surfaces of the bundles.

Gas phase oxidation was done using atmospheric air to make the process as simple as possible. The oxidation temperature (annealing temperature in our case) ranges from 200°C to 550°C. Although the annealing (oxidation) time can be as long as 5 hours and the temperature as high as 800°C, shorter times and lower oxidation temperatures are preferred to reduce the nanotube degradation. Gas phase oxidization is followed by

acid treatment for a number of times. The details of the compared procedures are as follows:

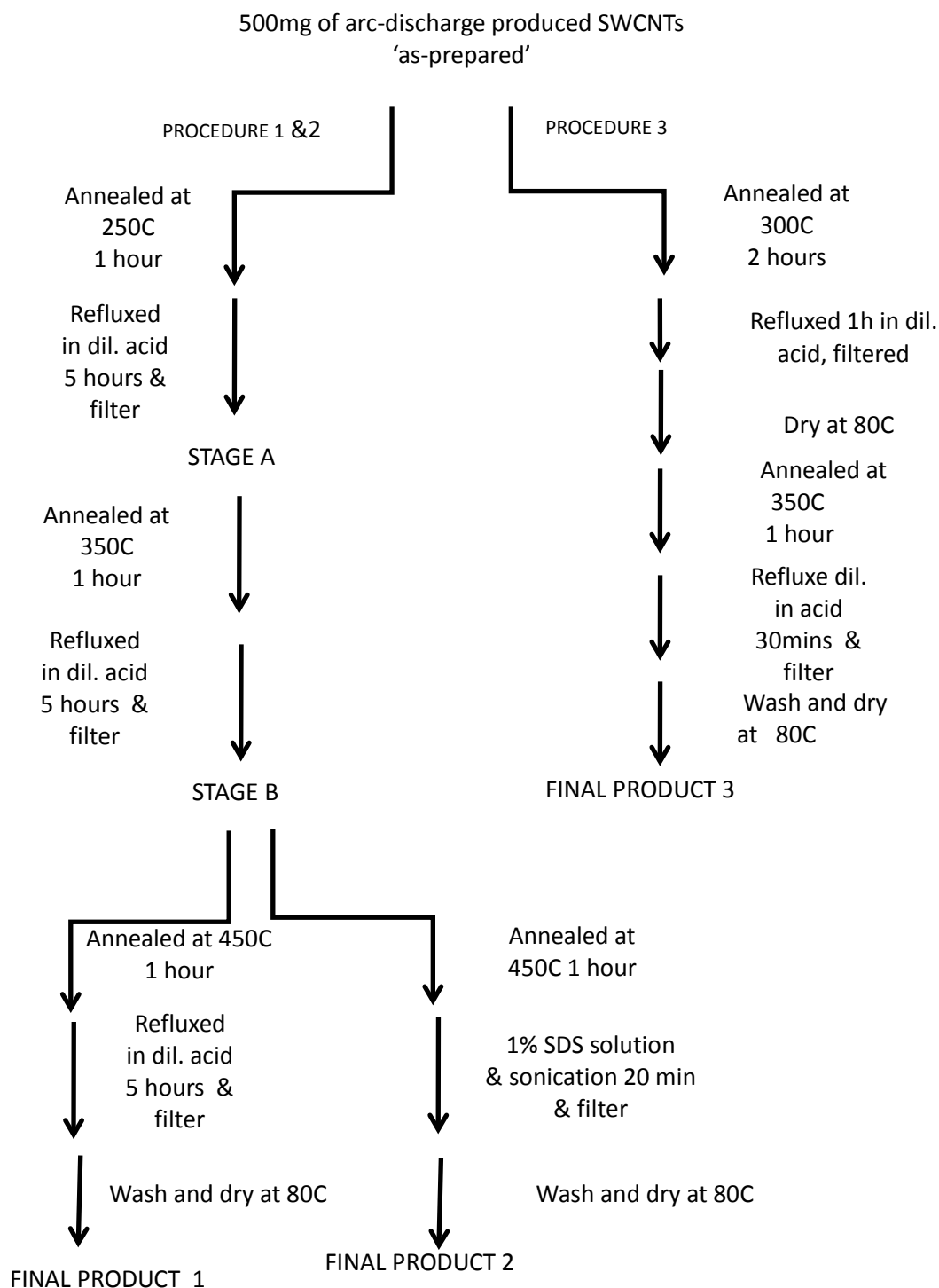

Procedure 1 [P1]

This procedure consists of a multi-step process of four cycles which includes a series of annealing and refluxing steps. 500mg of the SWCNTs were annealed in a furnace at 250°C for one hour, expecting to remove some of the non tubular forms of carbon. After cooling, the sample was refluxed in 200ml of 4M HCl at 100°C for about

5 hours in order to dissolve soluble impurities and metals (usually Ni and Y). The solution was then filtered using a Millipore membrane filter with pore size 0.45 μ m, and the filtrate was washed with distilled water. This helps separate the soluble impurities from the carbon nanotubes. After this first cycle of filtration, the second annealing is completed at 350°C for an hour followed by reflux with 4M HCl and filtration. A third cycle of purification was done by annealing the sample at 450°C. Finally the filtered and washed SWNTs were dried at 80°C and weighed to determine the yield. We also investigated the use of HNO₃ instead of HCl.

Procedure 2 [P2]

This procedure follows the same first two cycles as P1, while the third cycle is modified. After annealing and acid treatment at 450°C, the mixture was dispersed in 1% sodium dodecyl sulphate (SDS) solution (500mg of the purified SWNTs in 250ml of 1% SDS solution). This solution was sonicated for about 20 minutes to obtain a well dispersed solution. The solution was filtered using 0.45 μ m membrane filter and washed with ethanol and deionised water respectively. Finally, the filtrate was dried at 80°C.

Procedure 3 [P3]

This procedure is a two step process where the SWNT material is annealed at 300°C for two hours with subsequent reflux using 6M HCl at 130°C. After drying the material in an oven at 80°C, the sample was further annealed at 350°C for another one hour and then refluxed with 6M HCl at 130°C. Finally the sample was dried at 80°C.

Raman spectroscopy of the resultant samples was performed using a Renishaw 1000 system with a 785 nm laser. A Zeiss 1540 XB scanning electron microscope equipped with EDS was used to examine the samples. Thermogravimetric analysis and DTA were performed using a Netzsch TG instrument Model STA 409 PC.

Results and Discussion

Generally the as-produced SWNTs contain two types of impurities: transition metal catalyst particles (typically Ni and Y) and carbonaceous species, which include amorphous carbon, fullerenes, multishell carbon nanocapsules, and nanocrystalline graphites. Figure 1 shows a representative SEM image and EDS spectra of as-produced SWNTs where the major impurities can be identified qualitatively.

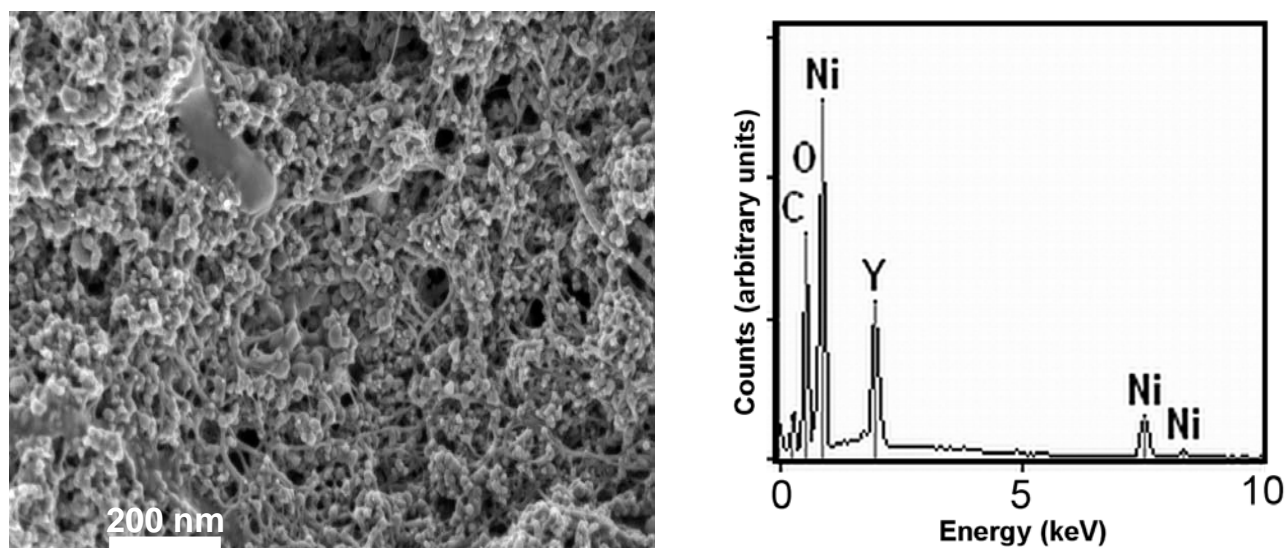
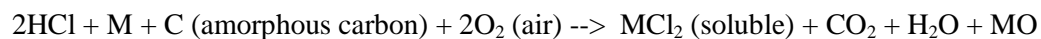

Figure 1: Representative (left) SEM image and (right) EDS spectrum of as-produced SWNTs showing the presence of Ni and Y catalyst in the sample as well as oxygen impurities.

Oxidation of the as-produced SWNTs at 250°C showed significant weight loss (Table 1), which shows the loss of carbonaceous materials. This gas phase oxidation is carried out prior to liquid phase oxidation in order to remove the carbonaceous impurities and amorphous carbon which surrounds the metal impurities and to expose the metals for chemical attack during chemical oxidation. It helps to remove amorphous carbon by oxidizing the amorphous carbon species to carbon oxides, and also converts the metal-containing catalyst particles into metal oxides and hydroxides. This process of oxidation later promotes further cracking and fracturing of the carbon encapsulation on the metal surface.

Acid treatment (4M HCl) of these samples also caused some weight loss, mainly due to removal of the metal catalysts. Acid reflux in 4M HCl results in a solution of greenish colour indicative of metal chlorides and metal oxides, showing successful significant removal of metal catalysts, as discussed above. Since the metal is insoluble in water and remains with the solute during filtration, further oxidation helps in removing the remaining metals.

Chemical reaction with HCl yields metal chlorides which are soluble in water. Normally halogen-containing acids, such as HCl, HF, HI and HBr result in soluble metal halides by reaction between the halogen-containing acid and metal, and the metal halides can be removed by washing with water. The HCl oxidant can also etch the carbon shell that has been weakened by the gas phase oxidation causing the metal catalysts to oxidize to their corresponding metal oxide (hydroxide). This is manifested by an increase in volume resulting in cracks and openings on the carbon coating. Generally, the oxidation process can be represented by the scheme:



Where M is the Metal catalyst present in the pristine SWNTs (Y, Ni)

We have investigated the effect of using concentrated HNO₃ instead of HCl. However in this case sample

damage was increased, and indeed by the end of the procedure the sample vanished completely due to successive exposure to oxidation by heat and acid. Although the use of HNO_3 acid is known to purify raw nanotubes [28], the low final yield (~ 3.8 wt%, as indicated in table 2) obtained from this procedure shows that HNO_3 introduces significantly more defects on the surface of the nanotubes than HCl treatment, which facilitates their subsequent destruction during oxidation due to loss of structural integrity.

Figure 2 is representative of the sample after this first cycle of oxidation-annealing, there remains a significant amount of carbon nanoparticles. Removing the remaining residual catalyst metal impurity from the single-wall carbon nanotube product is challenging, since the metal is usually encapsulated by a stable carbon coating which hinders the access of chemicals to the metal.

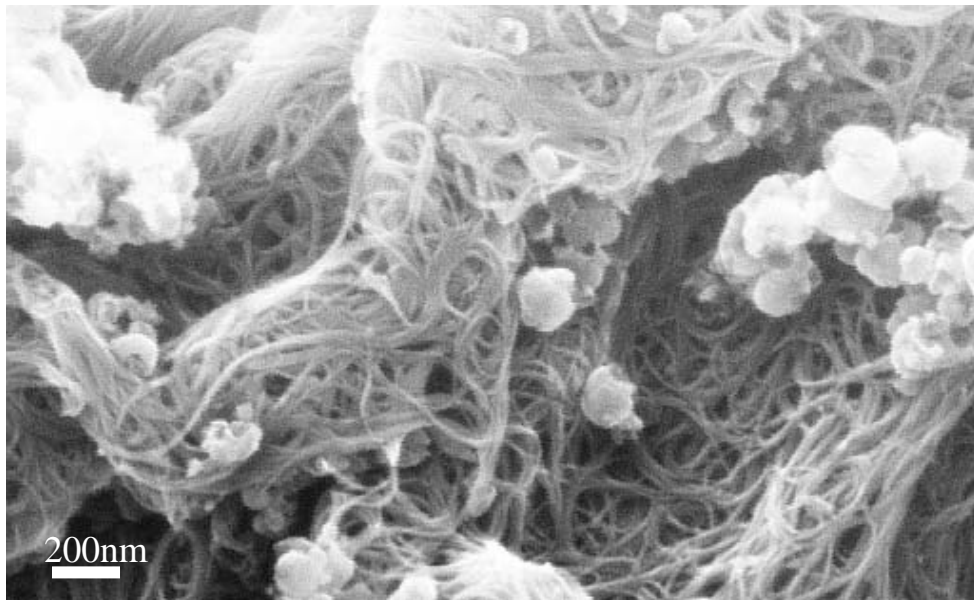

Figure 2. SEM image of SWNTs after annealing at 250°C and reflux in 4M HCl (STAGE A).

The major weight loss observed was at the secondary annealing at 350°C , (Table 1). At this temperature most of the carbonaceous matter, including many of the nanotubes, were eliminated. An SEM image of the sample at this stage after passing through a reflux process in 4M HCl is shown in Figure 3. The sample can be seen to be purer than that at 250°C , however, some impurities are still present indicating the need for further purification.

Table 1. Weight loss of SWNTs samples during purification process using Procedure 1 and 2, calculated with respect to the weight of sample obtained in the previous step. Figures in brackets show total percentage weight loss by this step as a function of initial sample weight. Both purification processes results in loss of about two thirds of the initial sample weight.

	Oxidation temperature [°C]	Resultant weight loss [%]	Main processes
First cycle	250	23 (23)	Oxidation in air followed by reflux with 4MHCl
Second cycle	350	51 (62)	Oxidation in air followed by reflux with 4MHCl
Third cycle	450	9 (66)	(P1)Oxidation in air
	450	15.5 (68)	(P2) Oxidation in air followed by reflux with 4MHCl and then dispersing in SDS solution by sonication.

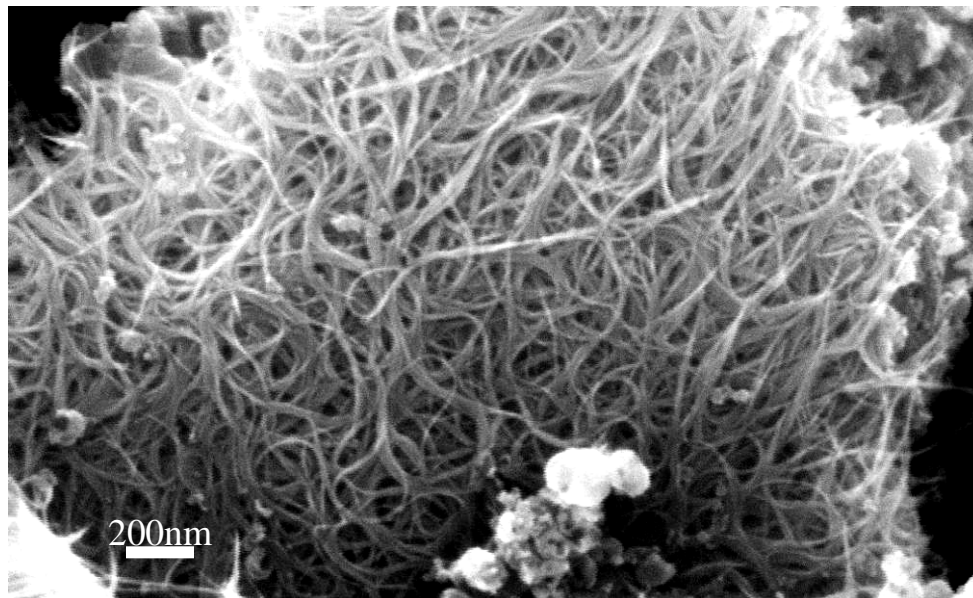

Figure 3. SEM image of purified SWNTs after the secondary oxidation at 350 °C followed by reflux with 4M HCl.(STAGE B)

Further examination of the effect of annealing temperature on the purification process using successive annealing and refluxing with 4M HCl was done by implementing a third annealing step at 450°C. This did not result in improved purity since the sample is thermally degraded as a consequence of the high temperature and prolonged exposure to acids. The SEM image of these tubes indicates that the SWNTs were seriously damaged and destroyed as shown in figure 4. There are several factors that contributed to the loss and destruction of SWNTs:

1. The exothermic nature of the oxidation process makes it difficult to accurately control the temperature of

the SWNT inside the annealing bath, and indeed some nanotube material was seen burning off.

2. The presence of encapsulated metal catalysts aggravate the oxidation reaction, thus SWNTs are observed to be completely destroyed to amorphous carbon at lower temperature than their oxidizing temperature.

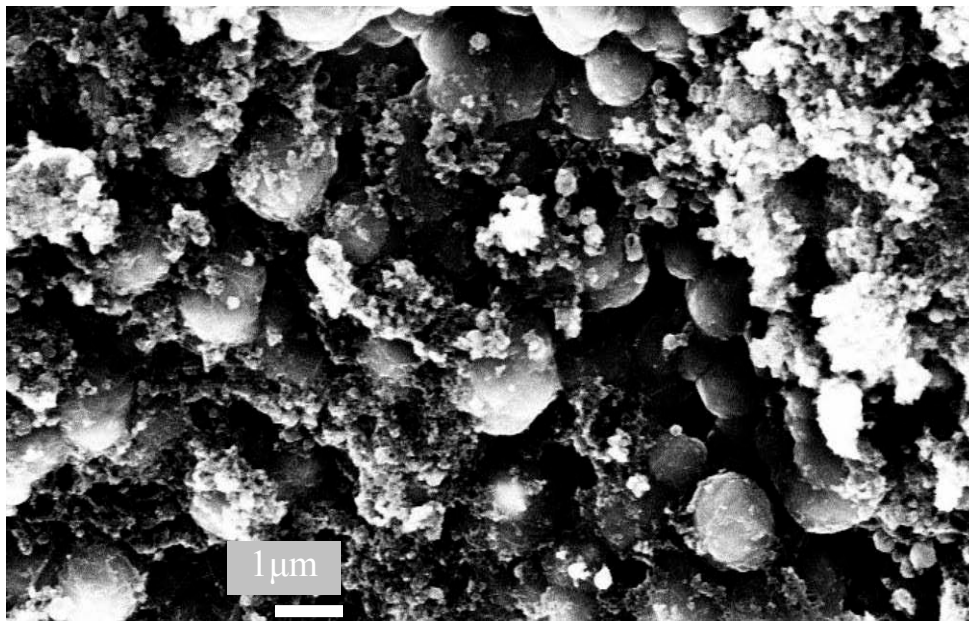

Figure 4. SEM image of sample after third annealing at 450°C and reflux with 4M HCl showing the destruction of SWNTs (FINAL PRODUCT 1)

Since it is not clear from the SEM images after this third step whether any nanotubes remain, we repeated the purification procedure but after the third annealing and acid reflux cycle we treated the sample with SDS (Procedure 2). SDS is known to render nanotubes soluble in water and thus provides a route to extract any remaining tubes from the mixture. This will then exclude the metallic nanoparticles so that they will get washed easily by water. The mixture was sonicated for 5 hours at low power using a horn sonicator to improve dispersion. Although a good dispersion was observed visually in the solution, the final results were still destroyed SWNTs with smaller yield ~10% of the initial raw sample, as shown in Table 2. The weight losses at 250°C and 350°C are due to oxidation of most carbonaceous impurities to oxides of carbon (CO and CO₂) and oxidation of the metal to metal chlorides, similar to the previous procedure. The additional weight loss observed as compared to Procedure 1 is due to the removal of metallic oxide impurities. However the nanotubes were totally distorted due to increased temperature and prolonged sonication power, as shown in Figure 5.



Figure 5. SEM image of SWNTs after Procedure 2 (described in the text) showing the nanotubes have primarily been converted to amorphous carbon. (FINAL PRODUCT 2)

Table 2. Final sample yield (%) after different purification procedures (see text)

Purification Procedure	Yield (%)
P1	18
P2	10
P3	26
P1 with HNO ₃ instead of HCl	4.5

We note that in all the purification processes sample holder size plays a significant role in controlling the oxidizing temperature. The larger the container, the more controlled the oxidation, since the increased available volume allows heat liberation from the sample surface, avoiding burning of nanotubes due to exothermic reaction.

In light of the above results, a new two annealing step purification method (Procedure 3) was developed. In this method, a first annealing step at 300°C removes significant amount of amorphous carbon and subsequent acid treatment in 6M HCl removes the metal catalysts. This is followed by a second oxidation step at 350°C which cracks and fractures the encapsulates of the metal nanoparticles. This exposes encapsulated metal particles for the final acid treatment which almost removes most of the metal catalyst. The process yields SWNTs of good purity, as shown qualitatively in the EDS spectra (Figure 6).

By limiting the oxidation temperature to 350°C we ensure minimal loss of carbon nanotubes. As a result, the final yield after purification reaches ~26%, see table 2. Figure 6 shows a representative SEM image of resultant SWNTs showing their high purity and lack of large scale damage as compared to the previous procedures. We

further analyse the product from Procedure 3 using Raman spectroscopy, SEM coupled with EDS and thermogravimetrics

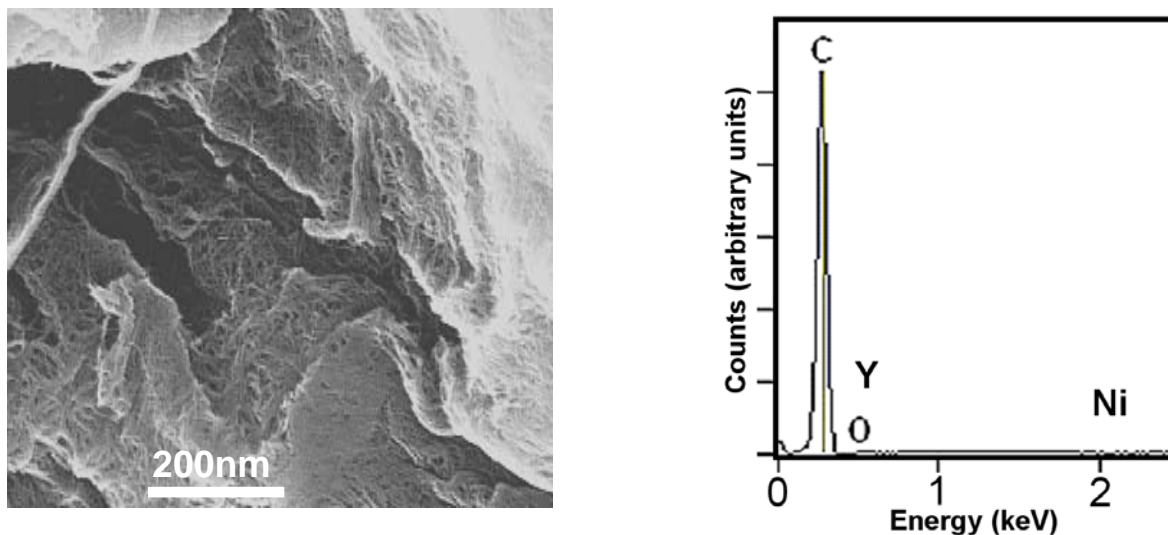

Figure 6. (left) Representative SEM image of SWNTs purified following Procedure 3 (see text), showing relatively high purity compared with the previously described purification routes, (right) EDS of the purified sample showing low metallic impurity content as compared to the raw sample in Figure 1. (FINAL PRODUCT 3)

In Figure 7 the Raman spectra of the raw and purified SWCNTs are shown. The G band is an indication of the graphitic quality of the sample while the D band is normally taken as an indication of degree of disorder. The full-width-half-maxima (FWHM) of the D band is an indication of the amount of carbonaceous impurities. The sample quality (defect density) can be checked by comparing the D to G band Raman intensity. These are given for the raw and purified samples in Table 3. The D to G peak intensity ratio drops by a factor of nearly three on purification, while the D peak FWHM drops by 43%, confirming the improved purity after treatment. This behaviour in the peak intensity is quite typical for acid treated tubes in which the peak originating from metallic tubes decreases when the tubes are acid treated due to a loss of continuum states as a result of functionalisation of the tubes compared to the raw tubes. This change has also been reported elsewhere [29]. This loss of broad Breit-Wigner-Fano feature has also been ascribed to debundling of the tubes [30] which could occur during our purification procedure as the nanotube surfaces become functionalised and charged during acid treatment. There remains a small D peak contribution, probably due to the presence of tube defect introduced by the acid treatment. Dillion et al [31] found that the D/G intensity ratio never fell below 0.005 for purified samples.

Table 3. Numerical values of the D and G-bands of raw and purified SWNTs retrieved from their respective raman spectra.

Raman band	Frequency [cm^{-1}]	Intensity	FWHM [cm^{-1}]
------------	--------------------------------	-----------	---------------------------

		Ratio (I_D/I_G)		
Raw-SWNTs	D	1294	0.100	83
	G	1583		-
Purified SWNTs (P3)	D	1295	0.037	36
	G	1591		-

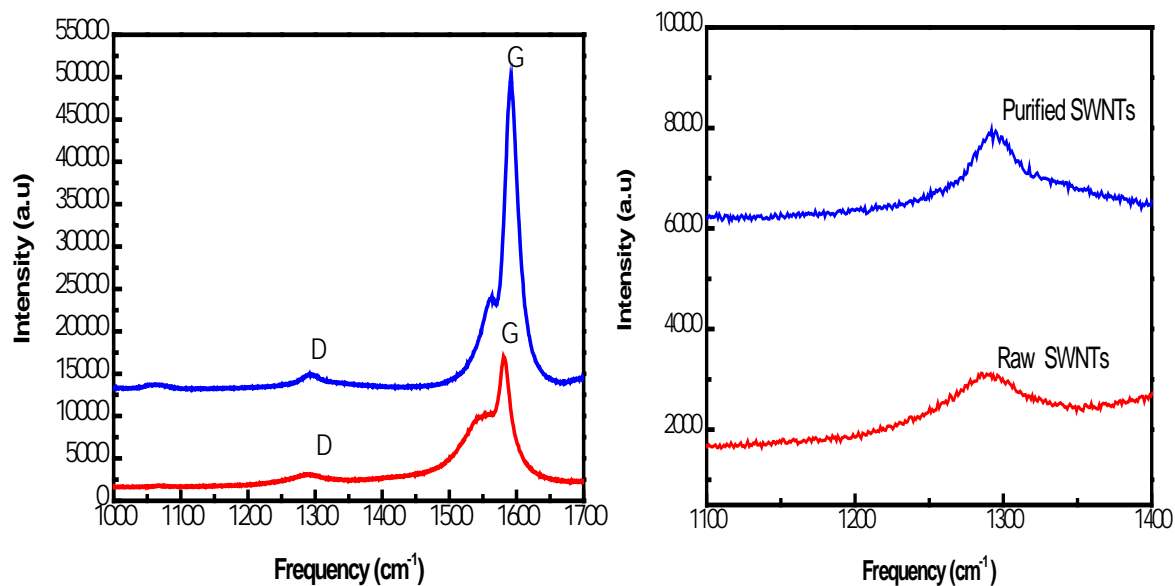

Figure 7. Raman spectra for raw (red, lower) and treated (blue, higher) SWNTs. Right hand figure shows a zoom of the D-band.

Thermo-gravimetric analysis (TGA) and differential thermo-gravimetric (DTG) studies of the raw and treated samples were performed to assess the composition with respect to metals, SWNTs, and other carbonaceous species. Since the gas flow used is air, we assume that when heating, all the carbon and metals are converted to their corresponding oxides.

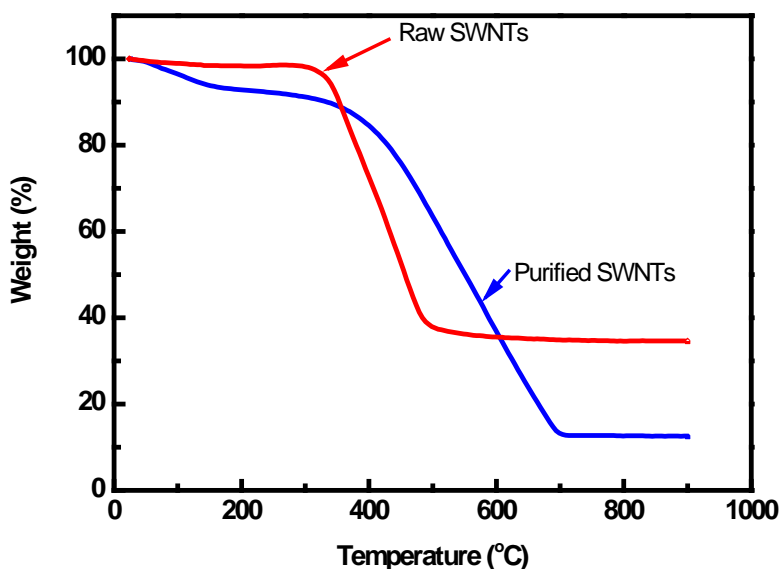

Figure 8. TG curves for raw and purified SWNTs obtained at a heating rate of 10 °C/min.

The TG curves of both raw and purified SWNTs are presented in Figure 8, with corresponding DTG curves in Figure 9. The sharp weight loss of the raw SWNTs commencing at ~300°C is due to oxidation of excess carbonaceous material. This weight loss extends to 470°C leaving an overall weight residue of ~ 32% in the crucible consisting largely of Y, Ni and Co catalyst particles. The treated material has a lower weight residue of ~12%, showing the importance of acid treatment after the first step of gas phase oxidation for catalyst removal. The different structural forms of carbon exhibit different reactivity towards oxidation. In general the purified tubes break down at a higher temperature than the amorphous carbon which can be seen by the higher weight loss onset temperature for the purified sample (350-400°C), consistent with previous reports [13, 32, 33]. The corresponding most rapid weight loss observed in the DTG curve for the purified sample (Figure 9B) at ~540°C shows an upshift of ~170°C compared to the raw SWNTs. This is evidence for the thermal stability of purified SWNTs and confirms that the purification procedure depletes most of the amorphous carbonaceous structures present in the as-prepared SWNT sample. This is nonetheless lower than literature temperatures for thermal degradation of undamaged SWNTs (~660°C) [34], consistent with the Raman data indicating that the nanotubes contain a fraction of defects and functional groups attached to the side (end) walls. Hence, these nanotubes are oxidize at lower temperature (~550°C) than the less defective SWNTs.

The sharp drop in the DTG at ~110 °C for the treated sample, and the observed continuous weight loss from room temperature and above in the TGA, is due to loss of water molecules. These we tentatively ascribe to breakdown and loss of –COOH groups introduced during the acid treatment, as well as the loss of residual water which will be hydrogen bonded to the hydrophilic –COOH surface groups on the tube surfaces and trapped in the bundles.

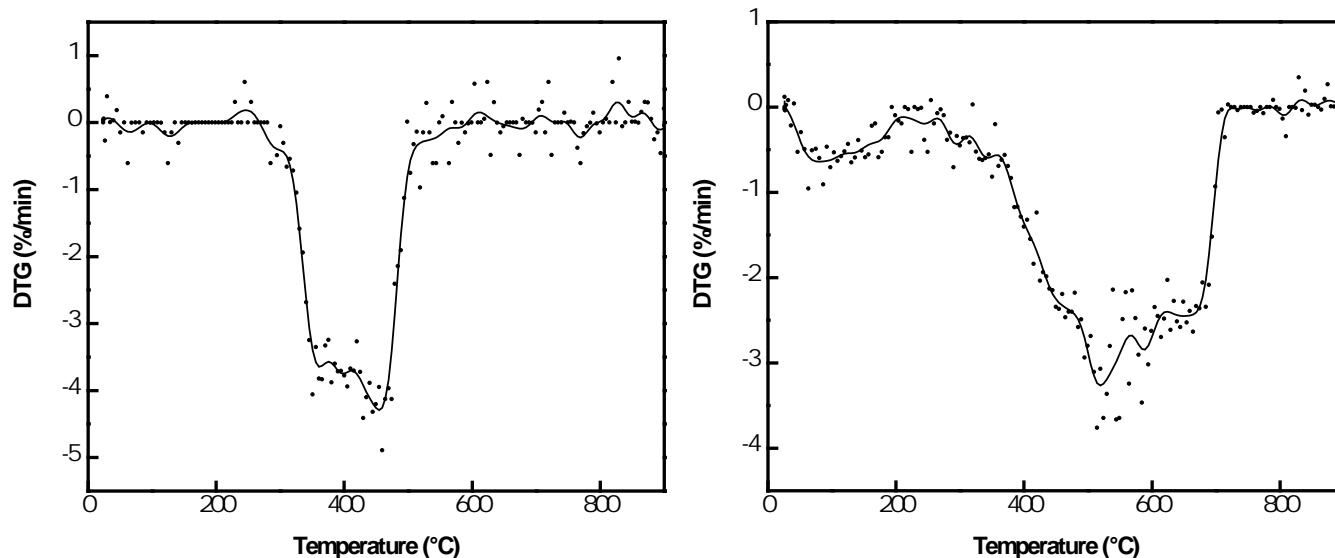

Figure 9. DTG curves obtained at a heating rate of 10 °C/min for the (A) raw and (B) purified SWNTs (curves are FFT fit to the data as a guide to the eye).

Conclusions

We have examined several oxidation methods to purify single-walled carbon nanotubes produced by the arc-discharge method. After analysing the purity using SEM, EDS, TGA and Raman spectroscopy, we found that a two-annealing step purification procedure where the sample is oxidised in air at 300°C and 350°C with subsequent acid treatment in 6M HCl gave samples which were a good compromise between reasonably high purity and good yields (>25%), albeit with some surface defects introduced on the walls of nanotubes. In addition the process has the added advantage of being less time consuming (complete in 4.5 hours) than conventional acid purification methods which require significantly more than 5 hours.

Acknowledgement

A.Yaya and A.G.Tekley acknowledges support from the European Commission for funding under the Erasmus Mundus scheme.

References

1. S.Iijima , T.Ichihashi, Nature, **363**, 603 (1993)
2. C. Niu , E.K.Sichel, R.Hoch, D.Moy, H.Tennent, Appl. Phys. Lett. **70**, 1480 (1997)
3. L.Diederich, E.Barborini, P.Piseri, A.Podesta, P.Milani, A.Schneuwly, R.Gallay, Appl. Phys. Lett. **75**, 2662 (1999)
4. G.T.Wu, C.S.Wang, X.B.Zhang, H.S.Yang, Z.F.Qi, P.M.He, W.Z.Li, J. Electrochem. Soc. **146**, 1696 (1999)
5. E.Franckowiak, S.Gautier, H.Gaucher, S.Bonnamy, F.Beguin, Carbon **37**, 61, (1999)
6. A.M.Cassel, J.A.Raymakers, J.Kong, H.Dai, J. Phys. Chem. B **103**, 6484, (1999)
7. C.Journet, W.K.Maser, P.Bernier, A.Loiseau, M. Lamy de la Chapelle, S.Lefrant, P.Daniard, R.Lee, J.E.Fischer, Nature **388**, 756, (1997)
8. Y.Saito, Y.Tani, N.Miyagawa, K.Mitsushima, A.Kasuya, Y.Nishina, Chem. Phys. Lett. **294**, 593, (1998)
9. Z.J.Shi , Y.F.Lian, X.H.Zhou, Z.N.Gu, Y.Zhang, S.Iijima, L.X.Zhou, K.T.Yue, S.L.Zhang, Carbon **37**, 1449, (1999)
10. T.Guo, P.Nikolaev, A.Thess, D.T.Colbert, R.E.Smalley, Chem. Phys. Lett. **49**, 243, (1995)
11. T.W.Ebbesen, P.M. Ajayan, H.Hiura, K.Tanigaki, Nature **367**, 519, (1994)
12. I.W.Chiang, B.E.Brinson, R.E.Smalley, J.L.Margrave, R.H.Hauge, J.Phys. Chem. B **105**, 1157, (2001)
13. P-X.Hou, C.Liu, H-M.Cheng, Carbon **46**, 2003, (2008)
14. Z.J.Shi, Y.F.Lian, F.H.Liao, X.H.Zhou, Z.N.Gu, Y.Zhang, S.Iijima, Solid State Commun. **35**, 112, (1999)
15. K.Tohji, H.Takahashi, Y.Shinoda, N.Shimizu, B.Jeyadevan, I.Matsuoka, Y.Saito, A.Kasuya, S.Ito, Y.Nishina, J. Phys. Chem. B **101**, 1974, (1997)
16. B.Liu, T.Wagberg, E.Olssen, R.Yang., H.Li, S.Zhang, H.Yang, G.Zou, B.Sundqvist, Chem Phys. Lett. **320**, 365, (2000)
17. S.Bandow, A.M.Rao, K.A.Williams, A.Thess, R.E.Smalley, P.C.Ecklund, J.Phys.Chem. B **101**, 8839, (1997)
18. K.B.Shelimov, R.O.Esenaliev, A.G. Rinzler, C.B.Huffman, R.E.Smalley, J.Chem. Phys. Lett. **282**, 429, (1998)
19. A.Yu, E.Bekyarova, M.E. Itkis, D.Fakhrutdinov, R.Webster, R.C.Haddon., J. Amer. Chem. Soc. **128**, 9902, (2006)
20. W.Li, Y.Bai, Y.Zhang, M.Sun, R.Cheng, X.Xu, Y.Chen, Y.Mo, Synth. Met. **155**, 509, (2005)
21. P.X.Hou, S.Bai, Q.H.Yang, C.Liu, H.M.Cheng, Carbon **40**, 81, (2002)
22. J.-M. Moon, K.H.An, Y. H. Lee, Y. S. Park, D. J. Bae, G. -S. Park, J. Phys. Chem. B **105**, 5677, (2001)
23. U.Chen, M.L.H.Green, J.L.Griffin, J.Hammer, R.M.Lago, S.C.Tsang, Adv. Mater. **8**, 1012, (1996)
24. J.L.Zimmerman, R.K.Bradley, C.B.Huffman, R.H.Hauge, J.L.Margrave, Chem. Mater. **12**, 1361, (2000)
25. P. J. F. Harris, Carbon Nanotube Science, Cambridge University Press, New York (2009)
26. V. Georgakilas, D.Voulgaris, E.Vazquez, M.Prato, D.M.Guldi, A.Kukovecz., H.Kuzmany, J. Am. Chem. Soc. **124**, 14318 (2002)

27. Z. Zhao, H.Hu, S.Niyogi, M.E.Itkis, M.A.Hamon, P.Bhowmik, M.S.Meier, R.C.Haddon, J Am.. Chem. Soc. **123**, 11673 (2001)
28. <http://www.carbolex.com/products.html> (retrieved on 14/03/2008).
29. G.S.Duesberg, S.Roth, P.Downes, A.Minett, R.Graupner, L.Ley, N.Nicoloso, Chem. Mater. **15**, 3314, (2003)
30. C. Jiang, K. Kempa, J. Zhao, U. Schlecht, U. Kolb, T. Basché, M. Burghard, A. Mews, Phys. Rev. B **66**, 161404(R) (2002)
31. A.C.Dillon, T.Gennett, K.M.Jones, J.L.Alleman, P.A.Parilla, M.J.Heben , Adv. Mater. **11**, 1354 (1999)
32. J. P. C. Triguero, G. G. Silva, R. L. Lavall, C. A. Furtado, S. Oliveira, A. S. Ferlauto, R. G. Lacerda, L. O. Ladeira, J;-W. Liu, R. L. Frost, G. A. George, J. Nanosci. And Nanotech. **7** (10) 3477 (2007)
33. R.B.Mathur, S.Seth, C.Lal, R.Rao, B.P.Singh, T.L.Dhami, A.M.Rao, Carbon **45**, 132 (2007)
34. http://www.msel.nist.gov/Nanotube2/Practice%20Guide_Section%202_TGA.pdf (retrieved on 13/11/2008)