



HAL
open science

Coxeter orbits and Brauer trees III

Olivier Dudas, Raphaël Rouquier

► **To cite this version:**

| Olivier Dudas, Raphaël Rouquier. Coxeter orbits and Brauer trees III. 2012. hal-00686064

HAL Id: hal-00686064

<https://hal.science/hal-00686064>

Preprint submitted on 6 Apr 2012

HAL is a multi-disciplinary open access archive for the deposit and dissemination of scientific research documents, whether they are published or not. The documents may come from teaching and research institutions in France or abroad, or from public or private research centers.

L'archive ouverte pluridisciplinaire **HAL**, est destinée au dépôt et à la diffusion de documents scientifiques de niveau recherche, publiés ou non, émanant des établissements d'enseignement et de recherche français ou étrangers, des laboratoires publics ou privés.

Coxeter orbits and Brauer trees III

Olivier Dudas* Raphaël Rouquier

April 6, 2012

Abstract

This article is the final one of a series of articles (cf. [19, 18]) on certain blocks of modular representations of finite groups of Lie type and the associated geometry. We prove the conjecture of Broué on derived equivalences induced by the complex of cohomology of Deligne-Lusztig varieties in the case of Coxeter elements whenever the defining characteristic is good. We also prove a conjecture of Hiß, Lübeck and Malle on the Brauer trees of the corresponding blocks. As a consequence, we determine the Brauer trees (in particular, the decomposition matrix) of the principal ℓ -block of $E_7(q)$ when $\ell \mid \Phi_{18}(q)$ and $E_8(q)$ when $\ell \mid \Phi_{18}(q)$ or $\ell \mid \Phi_{30}(q)$.

Introduction

This article is the final one of a series of articles on certain blocks of modular representations of finite groups of Lie type and the associated geometry. This series gives the first instance of use of the mod- ℓ cohomology of Deligne-Lusztig varieties to determine new decomposition matrices of principal blocks for finite groups of Lie type.

In the first two articles [19, 18], the first author studied the integral ℓ -adic cohomology of Deligne-Lusztig varieties associated with Coxeter elements. For suitable primes ℓ , Broué [5] has conjectured that the complex of cohomology provides a solution to his abelian defect group conjecture for the principal block. On the other hand, Hiß, Lübeck and Malle have conjectured that the Brauer tree of the block can be recovered from the rational ℓ -adic cohomology, endowed with the action of the Frobenius [29]. In [19, 18], the relation between these conjectures was studied, and Broué's conjecture was shown to hold for Coxeter elements, with the some possible exceptions of types E_7 and E_8 . These are also the cases for which the conjecture of Hiß, Lübeck and Malle was still open. We give here a general proof of that conjecture and, as a consequence of [19, 18], of

*The first author is supported by the EPSRC, Project No EP/H026568/1 and by Magdalen College, Oxford

Broué's conjecture. The new ingredient is the study of the complex of cohomology, and the corresponding functor, in suitable stable categories. This requires proving first some finiteness properties for the complex, when viewed as a complex of ℓ -permutation modules with an action of the Frobenius endomorphism. A key input from [19, 18] is the property of the mod- ℓ cohomology associated with certain "minimal" eigenvalues of Frobenius to be concentrated in one degree. As a consequence, we determine the Brauer trees for the finite reductive groups of type E_7 and E_8 , for primes dividing the cyclotomic polynomial associated with the Coxeter number. We also obtain the previously unknown planar embeddings for the trees associated with the groups of type 2F_4 and F_4 . From [19, 18], we deduce that Broué's conjecture holds in the case of Coxeter elements whenever p is a good prime. Note that David Craven has recently proposed a conjecture for the Brauer trees of all unipotent blocks of finite groups of Lie type, together with a conjecture for the perversity function associated with the equivalences predicted by Broué [11, 12].

Let us describe in detail the structure of this article. In the first section, we start with an analysis of *good* algebras, *i.e.*, algebras for which every bounded complex with finite-dimensional cohomology is quasi-isomorphic to a complex with finite-dimensional components. Given a group, its group algebra is good over arbitrary finite fields if and only if the group is good, *i.e.*, the cohomology of the group and its profinite completion agree for any finite module. Consider a group Υ with a finite normal subgroup H such that Υ/H is good and let k be a finite field. We show that a complex of $k\Upsilon$ -modules whose restrictions to kH is perfect is quasi-isomorphic to a bounded complex of $k\Upsilon$ -modules whose restrictions to kH are finitely generated and projective. We apply this to the complex of cohomology of an algebraic variety X acted on by a monoid Υ^+ acting by invertible transformations of the étale site, where Υ is the group associated with Υ^+ . Let ℓ be a prime invertible on X . We show that the complex of mod- ℓ cohomology of X can be represented by a bounded complex of finite Υ -modules which are direct summands of permutation modules for H (building on [33, 34]). This is motivated by the geometric form of Broué's abelian defect conjecture: given G a finite group of Lie type and B a block with abelian defect group D , there should exist a Deligne-Lusztig variety X acted on by $H = G \times C_G(D)^{\text{opp}} \triangleleft \Upsilon^+$, where Υ/H is a braid group associated with a complex reflection group, and such that the complex of mod- ℓ cohomology of X provides a derived equivalence between the principal blocks of G and $N_G(D)$, the action of which arises from Υ/G . The results of the first section apply, at least when the complex reflection group does not have exceptional irreducible components of dimension ≥ 3 , as the corresponding braid group is good.

In the second section, we consider a reductive connected algebraic group \mathbf{G} endowed with an endomorphism F a power of which is a Frobenius endomorphism. We study the complex of cohomology of the Deligne-Lusztig variety associated with a parabolic subgroup with an F -stable Levi complement \mathbf{L} . Under

the assumption that the Sylow ℓ -subgroups of \mathbf{G}^F are cyclic, and that \mathbf{L} is the centraliser of one of them, we study the generalised eigenspaces of the Frobenius on the complex of cohomology (in the derived equivalence situation, they correspond to the images of the simple modules for $N_G(D)$). We determine their class in the stable category of \mathbf{G}^F .

The third section is devoted to mod- ℓ representations of $\mathbf{G}^F = \mathbf{G}(\mathbb{F}_q)$, where \mathbf{G} is simple and the multiplicative order of q modulo ℓ is the Coxeter number of (\mathbf{G}, F) (with a suitable modification for Ree and Suzuki groups). We show that the knowledge of the stable equivalence induced by the Coxeter Deligne-Lusztig variety, together with the vanishing results of [18], determine Green's walk around the Brauer tree of the principal block, as predicted by Hiß-Lübeck-Malle [29]. We also show how to determine the Brauer trees of the non-principal blocks. Finally, we draw the new Brauer trees for the types 2F_4 , F_4 , E_7 and E_8 .

1 Finiteness of complexes of chains

1.1 Good algebras

1.1.1 Locally finite modules. Let k be a field. Given B a k -algebra, we denote by $B\text{-Mod}$ the category of left B -modules, by $B\text{-mod}$ the category of B -modules that are finite-dimensional over k and by $B\text{-locfin}$ the category of locally finite B -modules, *i.e.*, B -modules which are union of B -submodules in $B\text{-mod}$. These are Serre subcategories of $B\text{-Mod}$. We denote by $B\text{-Proj}$ (resp. $B\text{-proj}$) the category of projective (resp. finitely generated projective) B -modules.

Given \mathcal{C} an additive category, we denote by $\text{Comp}(\mathcal{C})$ its category of complexes and by $\text{Comp}^b(\mathcal{C})$ its subcategory of bounded complexes. We denote by $\text{Ho}(\mathcal{C})$ the homotopy category of complexes of \mathcal{C} .

Assume now \mathcal{C} is an abelian category. Let $C \in \text{Comp}(\mathcal{C})$ and let $n \in \mathbb{Z}$. We put

$$\tau_{\leq n} C = \cdots \longrightarrow C^{n-2} \longrightarrow C^{n-1} \longrightarrow \ker d^n \longrightarrow 0$$

and

$$\tau_{\geq n} C = 0 \longrightarrow \text{coker} d^{n-1} \longrightarrow C^{n+1} \longrightarrow C^{n+1} \longrightarrow \cdots .$$

The derived category of \mathcal{C} will be denoted by $D(\mathcal{C})$. Given \mathcal{I} a subcategory of \mathcal{C} , we denote by $D_{\mathcal{I}}(\mathcal{C})$ the full subcategory of $D(\mathcal{C})$ of complexes with cohomology in \mathcal{I} . We put $\text{Ho}(B) = \text{Ho}(B\text{-Mod})$ and $D(B) = D(B\text{-Mod})$. Recall that an object of $D(B)$ is *perfect* if it is isomorphic to an object of $\text{Comp}^b(B\text{-proj})$. We refer to [30, §8.1] for basic definitions and properties of unbounded derived categories.

Lemma 1.1. *The category $D(B\text{-locfin})$ is a triangulated category closed under direct sums and it is generated by $B\text{-mod}$ as such.*

Proof. The category $B\text{-locfin}$ is closed under direct sums, hence $\text{Comp}(B\text{-locfin})$ is closed under direct sums. It follows that $D(B\text{-locfin})$ is closed under direct sums and the canonical functor $\text{Comp}(B\text{-locfin}) \longrightarrow D(B\text{-locfin})$ commutes with direct

sums [1, Lemma 1.5]. Let $C \in \text{Comp}(B\text{-locfin})$. We have $\text{hocolim}_{n \rightarrow \infty} \tau_{\leq n}(C) \simeq C$, i.e., there is a distinguished triangle

$$\bigoplus \tau_{\leq n}(C) \longrightarrow \bigoplus \tau_{\leq n}(C) \longrightarrow C \rightsquigarrow .$$

If C is right bounded, then $\text{hocolim}_{n \rightarrow -\infty} \sigma_{\geq n} C \xrightarrow{\sim} C$, where $\sigma_{\geq n} C = 0 \rightarrow C^n \rightarrow C^{n+1} \rightarrow \dots$ is the subcomplex of C obtained by stupid truncation. It follows that $B\text{-locfin}$ generates $D(B\text{-locfin})$ as a triangulated category closed under direct sums.

Since $\text{hocolim}_{n \rightarrow -\infty} \sigma_{\geq n} C \simeq M$, we deduce that M is in the smallest triangulated subcategory of $D(B\text{-locfin})$ closed under direct sums and containing $B\text{-mod}$, and the lemma follows. \square

Lemma 1.2. *The canonical functor $D^b(B\text{-mod}) \rightarrow D_{B\text{-mod}}^b(B\text{-locfin})$ is an equivalence.*

Proof. Let $C \in \text{Comp}^b(B\text{-locfin})$ with $C^i = 0$ for $i > 0$, $H^i(C) = 0$ for $i \neq 0$ and $H^0(C) \in B\text{-mod}$. Since C^0 is locally finite, we deduce there is a B -submodule D^0 of C^0 which is finite-dimensional over k and such that $D^0 + d^{-1}(C^{-1}) = C^0$. We define now $D^{-i} \subset C^{-i}$ by induction on i for $i \geq 1$. We let D^{-i} be a B -submodule of C^{-i} that is finite-dimensional over k and such that $d^{-i}(D^{-i}) = d^{-i}(C^{-i}) \cap D^{-i+1}$. This defines a subcomplex D of C such that $D \hookrightarrow C$ is a quasi-isomorphism.

We deduce that given $M \in B\text{-mod}$ and $N \in D^b(B\text{-mod})$, the canonical map $\text{Hom}_{D^b(B\text{-mod})}(M, N) \rightarrow \text{Hom}_{D^b(B\text{-locfin})}(M, N)$ is an isomorphism. Since $D^b(B\text{-mod})$ is generated by $B\text{-mod}$ as a triangulated category, we deduce that the functor of the lemma is fully faithful. It is then an equivalence, since $B\text{-mod}$ also generates the triangulated category $D_{B\text{-mod}}^b(B\text{-locfin})$. \square

Lemma 1.3. *The following assertions are equivalent:*

- (1) *the canonical functor $D^b(B\text{-mod}) \rightarrow D_{B\text{-mod}}^b(B\text{-Mod})$ is an equivalence*
- (2) *the canonical functor $D^b(B\text{-mod}) \rightarrow D_{B\text{-mod}}^b(B\text{-Mod})$ is essentially surjective.*
- (3) *given $M, N \in B\text{-mod}$ and given $n \geq 1$, the canonical map $\text{Ext}_{B\text{-mod}}^n(M, N) \rightarrow \text{Ext}_{B\text{-Mod}}^n(M, N)$ is bijective.*
- (4) *given $M, N \in B\text{-mod}$ and given $n \geq 2$, the canonical map $\text{Ext}_{B\text{-mod}}^n(M, N) \rightarrow \text{Ext}_{B\text{-Mod}}^n(M, N)$ is surjective.*

Proof. The implication (3) \Rightarrow (1) follows from the fact that $D^b(B\text{-mod})$ is generated by $B\text{-mod}$ as a triangulated category.

The implication (4) \Rightarrow (3) is proven as in [35, Exercice 1(a) p.13] by induction on n (the case $n = 1$ holds with no assumption). Let $f \in \text{Ext}_{B\text{-mod}}^{n+1}(M, N)$: it is represented by a long exact sequence

$$0 \longrightarrow N \longrightarrow N_1 \longrightarrow \dots \longrightarrow N_{n+1} \longrightarrow M \longrightarrow 0$$

of objects of $B\text{-mod}$. We have a commutative diagram with exact rows

$$\begin{array}{ccccccc}
\mathrm{Ext}_{B\text{-mod}}^n(M, N_1) & \longrightarrow & \mathrm{Ext}_{B\text{-mod}}^n(M, N_1/N) & \longrightarrow & \mathrm{Ext}_{B\text{-mod}}^{n+1}(M, N) & \longrightarrow & \mathrm{Ext}_{B\text{-mod}}^{n+1}(M, N_1) \\
\downarrow \wr & & \downarrow \wr & & \downarrow & & \downarrow \\
\mathrm{Ext}_{B\text{-Mod}}^n(M, N_1) & \longrightarrow & \mathrm{Ext}_{B\text{-Mod}}^n(M, N_1/N) & \longrightarrow & \mathrm{Ext}_{B\text{-Mod}}^{n+1}(M, N) & \longrightarrow & \mathrm{Ext}_{B\text{-Mod}}^{n+1}(M, N_1)
\end{array}$$

The image of f in $\mathrm{Ext}_{B\text{-mod}}^{n+1}(M, N_1)$ vanishes. We deduce that f is the image of a map $g \in \mathrm{Ext}_{B\text{-mod}}^n(M, N_1/N)$. If $f \neq 0$, then $g \neq 0$ and, by induction, the image of g in $\mathrm{Ext}_{B\text{-Mod}}^n(M, N_1/N)$ is not zero. By chasing on the commutative diagram above, we deduce that the image of f in $\mathrm{Ext}_{B\text{-Mod}}^{n+1}(M, N)$ is not zero.

Let us assume now (2). Let $n \geq 2$, let $f \in \mathrm{Hom}_{D^b(B\text{-Mod})}(M, N[n])$ and let C be the cone of f . It is the image of an object D of $D^b(B\text{-mod})$ and there is a distinguished triangle $H^{-n}(D)[n] \rightarrow D \rightarrow H^{-1}(D)[1] \rightsquigarrow$. This triangle defines a map $M = H^{-1}(D) \rightarrow N[n] = H^{-n}(D)[n]$ lifting f . This shows (4). Note finally that (1) \Rightarrow (2) is trivial. \square

We say that B is *good* if it satisfies any of the equivalent assertions of Lemma 1.3.

Lemma 1.4. *Let A be a subalgebra of a k -algebra B making B into a finitely generated projective A -module. Then A is good if and only if B is good.*

Proof. Under the assumption of the lemma, the pair $(F, G) = (\mathrm{Ind}_A^B, \mathrm{Res}_A^B)$ is an adjoint pair of functors which are exact and preserve finite-dimensionality. Furthermore, the canonical map $FG \rightarrow \mathrm{Id}$ is onto.

Let $M \in B\text{-mod}$. There is a surjective map $f : FG(M) \rightarrow M$. The kernel of f is a quotient of $FG(\ker f)$. Iterating this construction, we obtain a complex of B -modules $C = \dots \rightarrow C^{-1} \rightarrow C^0 \rightarrow 0$ with a morphism $C \rightarrow M$ that is a quasi-isomorphism and such that C^i is in $F(A\text{-mod})$. From Lemma 1.1 we deduce that $F(A\text{-mod})$ generates $D(B\text{-locfin})$ as a triangulated category closed under direct sums.

Given $i \geq 0$ and $V \in A\text{-mod}$, we have a commutative square

$$\begin{array}{ccc}
\mathrm{Ext}_{B\text{-mod}}^i(F(V), M) & \xrightarrow{\sim} & \mathrm{Ext}_{A\text{-mod}}^i(V, G(M)) \\
\downarrow & & \downarrow \\
\mathrm{Ext}_{B\text{-Mod}}^i(F(V), M) & \xrightarrow{\sim} & \mathrm{Ext}_{A\text{-Mod}}^i(V, G(M))
\end{array}$$

and we deduce that B is good whenever A is. The other implication is proven in the same way, by exchanging the role of A and B and by taking $(F, G) = (\mathrm{Res}_A^B, \mathrm{CoInd}_A^B)$. \square

Lemma 1.5. *Assume k is perfect and let A, B be k -algebras. If A and B are good, then $A \otimes_k B$ is good.*

Proof. The lemma follows from the Künneth Formula and the fact that $D^b((A \otimes_k B)\text{-mod})$ is generated by $A\text{-mod} \otimes B\text{-mod}$ as a triangulated category, as finite

dimensional simple $(A \otimes_k B)$ -modules are of the form $V \otimes_k W$, where V (resp. W) is a finite dimensional A -module (resp. B -module). \square

1.1.2 Relative homotopy categories. Let A be a subalgebra of a k -algebra B . We denote by $\text{Ho}(B, A)$ the quotient of the triangulated category $\text{Ho}(B)$ by the thick subcategory of complexes C such that $\text{Res}_A C = 0$ in $\text{Ho}(A)$. We have quotient functors $\text{Ho}(B) \rightarrow \text{Ho}(B, A) \rightarrow D(B)$. Taking for example $A = B$ or k gives $\text{Ho}(B, B) = \text{Ho}(B)$ and $\text{Ho}(B, k) = D(B)$.

Recall that a complex C of A -modules is *homotopically projective* if $\text{Hom}_{\text{Ho}(A)}(C, D) = 0$ given D any acyclic complex of A -modules. The following lemma is classical when $A = k$ [30, Theorem 8.1.1].

Lemma 1.6. *Assume B is a projective A -module. Let \mathcal{T} be the full subcategory of $\text{Ho}(B, A)$ of complexes C such that $\text{Res}_A C$ is homotopically projective. The quotient functor induces an equivalence $\mathcal{T} \xrightarrow{\sim} D(B)$, whose inverse is a left adjoint to the quotient functor $\text{Ho}(B, A) \rightarrow D(B)$.*

Proof. Let C be a homotopically projective complex of B -modules and D be an acyclic complex of A -modules. Since B is projective as an A -module, the complex $\text{CoInd}_A^B D = \text{Hom}_A(B, D)$ is acyclic. Consequently we have $\text{Hom}_{\text{Ho}(A)}(\text{Res}_A^B C, D) \simeq \text{Hom}_{\text{Ho}(B)}(C, \text{CoInd}_A^B D) = 0$. It follows that $\text{Res}_A^B C$ is homotopically projective.

Let now $C \in \mathcal{T}$. Consider a homotopically projective resolution of C , i.e., a morphism of complexes $f : C' \rightarrow C$ where C' is a homotopically projective complex and f is a quasi-isomorphism. Since $\text{Res}_A C'$ and $\text{Res}_A C$ are homotopically projective, we deduce that $\text{Res}_A f$ is an isomorphism in $\text{Ho}(A)$. Note that an arrow g of $\text{Ho}(B, A)$ is invertible if and only if $\text{Res}_A g$ is invertible in $\text{Ho}(A)$. It follows that f is an isomorphism in $\text{Ho}(B, A)$. Now, given $D \in \text{Comp}(B)$, we have canonical isomorphisms

$$\text{Hom}_{\text{Ho}(B)}(C', D) \xrightarrow{\sim} \text{Hom}_{\text{Ho}(B, A)}(C', D) \xrightarrow{\sim} \text{Hom}_{D(B)}(C', D)$$

and the lemma follows. \square

We denote by $R_D : D(B) \rightarrow D(A)$ and $R_{\text{Ho}} : \text{Ho}(B, A) \rightarrow \text{Ho}(A)$ the triangulated functors induced by the restriction Res_A^B . Given $E : \mathcal{C} \rightarrow \mathcal{C}'$ a functor and $\mathcal{I} \subset \mathcal{C}'$, we denote by $E^{-1}(\mathcal{I})$ the full subcategory of \mathcal{C} of objects C such that $E(C)$ is isomorphic to an object of \mathcal{I} .

Lemma 1.7. *Let A be a finite-dimensional subalgebra of a k -algebra B . Assume that there exists a subalgebra B' of B such that B is a finitely generated projective (A, B') -bimodule. Then the quotient functor induces an equivalence $R_{\text{Ho}}^{-1}(\text{Comp}^b(A\text{-Proj})) \xrightarrow{\sim} R_D^{-1}(\text{Comp}^b(A\text{-Proj}))$.*

Furthermore, if B is good, this restricts to an equivalence $R_{\text{Ho}}^{-1}(\text{Comp}^b(A\text{-proj})) \xrightarrow{\sim} R_D^{-1}(\text{Comp}^b(A\text{-proj}))$.

Proof. The fully faithfulness is given by Lemma 1.6.

We construct by induction a complex of (B, B) -bimodules $X = \dots \rightarrow X^{-1} \rightarrow X^0 \rightarrow 0$. We put $X^0 = B \otimes_{B'} B$. Let M be the kernel of the multiplication map $X^0 \rightarrow B$. We put $X^{-1} = X^0 \otimes_B M$ and $d^{-1} : X^{-1} \rightarrow X^0$ is the composition $X^0 \otimes_B M \xrightarrow{\text{mult}} M \xrightarrow{\text{can}} X^0$. Suppose $X^{-i} \rightarrow \dots \rightarrow X^0 \rightarrow 0$ has been defined for some $i \geq 1$. We put $X^{-i-1} = X^0 \otimes_B \ker d^{-i}$ and $d^{-i-1} : X^{-i-1} \xrightarrow{\text{mult}} \ker d^{-i} \xrightarrow{\text{can}} X^{-i}$. The multiplication map $X \rightarrow B$ is a quasi-isomorphism. Note that X^0 is a (B, B) -bimodule that is finitely generated and projective as an (A, B) -bimodule and as a B -module. By induction, we deduce that X^{-i} is finitely generated and projective as an (A, B) -bimodule and as a B -module, and $\ker d^{-i}$ is a direct summand of X^{-i} as a left and as a right B -module.

Let C be an object of $R_D^{-1}(\text{Comp}^b(A\text{-Proj}))$. It is a bounded complex of B -modules such that $\text{Res}_A C$ is quasi-isomorphic to a bounded complex of projective modules C' . Let $n \in \mathbb{Z}$ be such that the terms of C' are zero in degrees $< n$. Let us consider the complex $D = X \otimes_B C$. The canonical map $D \rightarrow C$ is a quasi-isomorphism and $\text{Res}_A D$ is a right bounded complex of projective modules that is quasi-isomorphic to C' . Consequently, $\text{Res}_A D$ is homotopy equivalent to C' , and so is $\text{Res}_A(\tau_{\geq n} D)$ since $\tau_{\geq n} C' = C'$. We deduce that $\tau_{\geq n} D$ is a bounded complex of B -modules whose restriction to A are projective. This shows the first part of the lemma. Note that if the terms of C are finite-dimensional, then the terms of $\tau_{\geq n} D$ are finite-dimensional as well.

We consider finally a bounded complex M of B -modules whose restriction to A is perfect. Since A is finite-dimensional, we deduce that M has finite-dimensional total cohomology, hence it is quasi-isomorphic to an object C of $D^b(B\text{-mod})$, as B is good. The construction above gives a quasi-isomorphic bounded complex $\tau_{\geq n} D$ of B -modules whose restriction to A are finitely generated and projective. \square

If B is a projective A -module we have the following picture:

$$\begin{array}{ccc}
\text{Ho}(B, A) & \xrightarrow{\quad} & D(B) \\
\uparrow \wr & & \uparrow \wr \\
R_{\text{Ho}}^{-1}(A\text{-hoProj}) & \xrightarrow{\sim} & R_D^{-1}(A\text{-hoProj}) \\
\uparrow \wr & & \uparrow \wr \\
R_{\text{Ho}}^{-1}(\text{Comp}^b(A\text{-Proj})) & \hookrightarrow & R_D^{-1}(\text{Comp}^b(A\text{-Proj})) \\
\uparrow \wr & & \uparrow \wr \\
R_{\text{Ho}}^{-1}(\text{Comp}^b(A\text{-proj})) & \hookrightarrow & R_D^{-1}(\text{Comp}^b(A\text{-proj}))
\end{array}$$

Remark 1.8. All results in §1.1.1-1.1.2 except Lemma 1.5 generalise immediately to the case where the field k is replaced by any commutative noetherian ring.

1.1.3 Good groups. We relate in this section the property for a group to be good as defined in [35, §2.6, exercise 2], to the property of its group algebra to be good. We refer to [26, §3] for a discussion of goodness of groups.

Let Υ be a group and $\hat{\Upsilon}$ its profinite completion. We consider only continuous representations of $\hat{\Upsilon}$, *i.e.*, representations such that the orbit of any vector is finite. In particular, we have a fully faithful embedding $k\hat{\Upsilon}\text{-Mod} \rightarrow k\Upsilon\text{-locfin}$, and this embedding is an equivalence if k is a finite field. As a consequence, we have the following result:

Lemma 1.9. *Assume k is a finite field. The algebra $k\Upsilon$ is good if and only if given M a finite-dimensional $k\Upsilon$ -module and given $n \geq 0$, the canonical map $H^n(\hat{\Upsilon}, M) \rightarrow H^n(\Upsilon, M)$ is bijective.*

Following Serre [35, §2.6, exercise 2], a group Υ is said to be *good* if for any finite $\hat{\Upsilon}$ -module M , the canonical map $H^n(\hat{\Upsilon}, M) \rightarrow H^n(\Upsilon, M)$ is an isomorphism for all n (note that it is already bijective for $n = 0, 1$). It is equivalent to the requirement that $\mathbb{F}_p\Upsilon$ is good for all primes p .

Let V be a finite-dimensional complex vector space and let W be a finite subgroup of $\text{GL}(V)$. Assume it is a complex reflection group, *i.e.*, it is generated by elements fixing a hyperplane. Let $V_{\text{reg}} = \{v \in V \mid \text{Stab}_W(v) = 1\}$ and let $x_0 \in V_{\text{reg}}/W$. The braid group of W is $\pi_1(V_{\text{reg}}/W, x_0)$. We refer to [6] for basic properties of complex reflection groups and braid groups.

Recall that two groups are *commensurable* if they contain isomorphic subgroups of finite index. Lemma 1.4 shows that given Υ_0 a group commensurable with Υ , then $k\Upsilon$ is good if and only if $k\Upsilon_0$ is good.

The following result generalises [35, §2.6, exercise 2(d,e)].

Proposition 1.10. *If Υ is commensurable with a free group or the braid group of a complex reflection group with no exceptional irreducible component of dimension ≥ 3 , then Υ is good.*

Proof. If Υ is an iterative extension of free groups, then Υ is good by [35, §2.6, exercise 2(d)].

Assume Υ is the braid group of a complex reflection group of type $G(d, e, n)$. Then Υ is commensurable with an iterated extension of free groups (cf. [32] or [6, Remark p.152, Proposition 3.5, Lemma 3.9 and Corollary 3.32]). Consequently, Υ is good.

Finally, if Υ is the pure braid group of an irreducible 2-dimensional complex reflection group, then $Z(\Upsilon)$ is cyclic and $\Upsilon/Z(\Upsilon)$ is a free group [6, p.146], hence Υ is good.

The case of the braid group of a non-irreducible complex reflection group follows from Lemma 1.5. \square

Remark 1.11. We expect that the braid group of any finite complex reflection group is good.

Let H be a finite normal subgroup of Υ . It follows from [35, §2.6, exercise 2] that Υ/H is good if and only if Υ is good and there is a finite index subgroup of Υ intersecting H trivially. The following proposition follows from Lemma 1.7.

Proposition 1.12. *Let k be a finite field. If Υ/H is good, then the quotient map induces an equivalence from the full subcategory of $\mathrm{Ho}(k\Upsilon, kH)$ of complexes C such that $\mathrm{Res}_H C \in \mathrm{Comp}^b(kH\text{-proj})$ to the full subcategory of $D(k\Upsilon)$ of complexes D such that $\mathrm{Res}_H D$ is perfect.*

1.2 Complexes of chains with compact support

Let k be a finite field of characteristic ℓ . By variety, we will mean a quasi-projective scheme over an algebraically closed field of characteristic $p \neq \ell$. We will consider étale sheaves of k -vector spaces. Let us recall the construction of good representatives of the complex of chains up to homotopy. For finite group actions, the existence of such complexes is due to Rickard [33]. We need here to use [34, §2], which provides a direct construction compatible with the action of infinite monoids.

Let X be a variety acted on by a monoid Υ^+ acting by equivalences of the étale site. Let H be a finite normal subgroup of Υ^+ and Υ be the group deduced from Υ^+ .

We consider the complex of cohomology with compact support of X with value in k , constructed using the Godement resolution and we denote by $\mathrm{G}\Gamma_c(X)$ its $\tau_{\leq 2\dim X}$ -truncation. It is viewed as an object of $\mathrm{Ho}^b(k\Upsilon, kH)$. It is independent of the choice of the compactification, up to a unique isomorphism. Most functorial properties in $D^b(k\Upsilon)$ lift to $\mathrm{Ho}^b(k\Upsilon, kH)$, in particular the triangle associated with an open-closed decomposition: given Z a Υ^+ -stable closed subvariety of X and U the open complement, there is a distinguished triangle in $\mathrm{Ho}^b(k\Upsilon, kH)$

$$\mathrm{G}\Gamma_c(U) \longrightarrow \mathrm{G}\Gamma_c(X) \longrightarrow \mathrm{G}\Gamma_c(Z) \rightsquigarrow .$$

Lemma 1.13. *Assume the stabilisers of points in X under H are ℓ' -groups. Then $\mathrm{Res}_H \mathrm{G}\Gamma_c(X)$ is a bounded complex of projective modules and it is perfect.*

Furthermore, if Υ/H is good, then $\mathrm{G}\Gamma_c(X)$ is isomorphic in $\mathrm{Ho}^b(k\Upsilon, kH)$ to a complex $\tilde{\mathrm{R}}\Gamma_c(X)$ such that $\mathrm{Res}_H \tilde{\mathrm{R}}\Gamma_c(X) \in \mathrm{Comp}^b(kH\text{-proj})$.

Proof. It follows from [34, §2.5] that $\mathrm{Res}_H \mathrm{G}\Gamma_c(X)$ is a bounded complex of projective kH -modules and from [13, Proposition 3.5] that it is perfect. When Υ/H is good, we obtain the second part of the lemma from Proposition 1.12. \square

We explain now how to describe this finer invariant $\mathrm{G}\Gamma_c$ from the classical derived category invariant $\mathrm{R}\Gamma_c$ in general, by filtrating X . We define a filtration of X by open Υ^+ -stable subvarieties $X_{\leq i} = \{x \in X \mid |\mathrm{Stab}_H(x)| \leq i\}$. Each variety $X_{\leq i-1}$ is open in $X_{\leq i}$ and the complement is a locally closed subvariety of X which we will denote by X_i . Given $Q \subset H$, we put $X_Q = \{x \in X \mid \mathrm{Stab}_H(x) = Q\}$. Given C an Υ -conjugacy class of subgroups of H , we put $X_C = \coprod_{Q \in C} X_Q$. We

have a decomposition into open and closed subvarieties $X_i = \coprod_C X_C$, where C runs over the set of Υ -conjugacy classes of subgroups of H of order i . Given $Q \in C$, the map $(\gamma, x) \rightarrow \gamma x \gamma^{-1}$ induces an isomorphism $\text{Ind}_{N_\Upsilon(Q)}^\Upsilon X_Q \xrightarrow{\sim} X_C$. As a consequence, we have a distinguished triangle in $\text{Ho}^b(k\Upsilon, kH)$

$$\text{G}\Gamma_c(X_{\leq i-1}) \rightarrow \text{G}\Gamma_c(X_{\leq i}) \rightarrow \bigoplus_Q \text{Ind}_{N_\Upsilon(Q)}^\Upsilon \text{G}\Gamma_c(X_Q) \rightsquigarrow,$$

where Q runs over representatives of Υ -conjugacy classes of subgroups of order i of H .

The action of $N_H(Q)$ on X_Q factors through a free action of $N_H(Q)/Q$. Lemmas 1.13 and 1.7 show that $\text{G}\Gamma_c(X_Q)$ is up to isomorphism the unique object of $\text{Ho}^b(kN_\Upsilon(Q), kN_H(Q))$ isomorphic in $D^b(kN_\Upsilon(Q))$ to $\text{R}\Gamma_c(X)$ and whose restriction to $kN_H(Q)$ is homotopy equivalent to a bounded complex of projective $(kN_H(Q)/Q)$ -modules.

Recall that a kH -module is an ℓ -permutation module if it is a direct summand of a permutation module. The filtration of $\text{G}\Gamma_c(X)$ above shows that it is isomorphic in $\text{Ho}^b(k\Upsilon, kH)$ to a bounded complex of $k\Upsilon$ -modules whose restrictions to H are ℓ -permutation modules. The second part of Lemma 1.13 shows the following stronger finiteness statement.

Proposition 1.14. *Assume that Υ/H is good (cf. §1.1.3). Then the complex $\text{G}\Gamma_c(X)$ is isomorphic in $\text{Ho}^b(k\Upsilon, kH)$ to a bounded complex $\tilde{\text{R}}\Gamma_c(X)$ of $k\Upsilon$ -modules whose restrictions to H are finitely generated ℓ -permutation modules.*

In the setting of Broué's abelian defect conjecture, we have $\Upsilon = H \rtimes B$, where B is the braid group of a complex reflection group, so that Proposition 1.14 applies when the reflection group has no exceptional component of dimension ≥ 3 (cf. Proposition 1.10).

Let P be an ℓ -subgroup of H . Given V an ℓ -permutation kH -module, $\text{Br}_P(V)$ is defined as the image of the invariants V^P in the coinvariants $V_P = V \otimes_{kP} k$. This construction extends to complexes of ℓ -permutation modules. The description of $\text{G}\Gamma_c(X)$ above shows that the injection $X^P \hookrightarrow X$ induces an isomorphism

$$\text{Br}_P(\text{G}\Gamma_c(X)) \xrightarrow{\sim} \text{G}\Gamma_c(X^P)$$

in $\text{Ho}^b(kN_\Upsilon(P), kN_H(P)/P)$ (cf. also [34, Theorem 2.29] and [33, Theorem 4.2]).

Remark 1.15. The complex $\text{Res}_H \text{G}\Gamma_c(X_1)$ is homotopy equivalent to a bounded complex of finitely generated projective modules since by definition H acts freely on X_1 . As a consequence, the canonical map $\text{G}\Gamma_c(X) \rightarrow \text{G}\Gamma_c(X \setminus X_1)$ is an isomorphism in $\text{Ho}^b(kH\text{-Mod})/\text{Ho}^b(kH\text{-proj})$ (compare with Lemma 2.6).

Remark 1.16. Note that a finiteness property can be obtained more directly for Galois actions. Let $\check{C}(X, k)$ be the Čech complex of X , limit of the Čech complexes $\check{C}(\mathcal{F}, k)$ over the category of étale coverings \mathcal{F} of X . The action of Υ on that category induces an action on $\check{C}(X, k)$.

Assume now X is endowed with a Frobenius endomorphism F defining a rational structure over a finite field. Let $\alpha \in \check{C}(X, k)$. There is a covering \mathcal{F} such that α is in the image of $\check{C}(\mathcal{F}, k)$. The covering \mathcal{F} is isomorphic to a covering \mathcal{F}' whose elements are stable under the action of F^n and such that F^n acts trivially on $\check{C}(\mathcal{F}', k)$, for some $n \geq 1$. It follows that $F^n(\alpha) = \alpha$. So, $\check{C}(X, k)$ is locally finite for the action of F .

2 Deligne-Lusztig varieties

Let \mathbf{G} be a (not necessarily connected) reductive algebraic group, together with an isogeny F , some power of which is a Frobenius endomorphism. In other words, there exists a positive integer n such that F^n defines a split \mathbb{F}_{q^n} -structure on \mathbf{G} for a certain power q^n of the characteristic p , where $q \in \mathbb{R}_{>0}$. Given an F -stable algebraic subgroup \mathbf{H} of \mathbf{G} , we will denote by H the finite group of fixed points \mathbf{H}^F .

Let $\mathbf{P} = \mathbf{L}\mathbf{U}$ be a parabolic subgroup of \mathbf{G} with unipotent radical \mathbf{U} and an F -stable Levi complement \mathbf{L} . We define the parabolic Deligne-Lusztig varieties

$$\begin{array}{c} Y_{\mathbf{G}}(\mathbf{U}) = \{g \in \mathbf{G} \mid g^{-1}F(g) \in F(\mathbf{U})\}/(\mathbf{U} \cap F(\mathbf{U})) \\ \pi_L \downarrow /L \\ X_{\mathbf{G}}(\mathbf{P}) = \{g \in \mathbf{G} \mid g^{-1}F(g) \in F(\mathbf{P})\}/(\mathbf{P} \cap F(\mathbf{P})) \end{array}$$

where π_L denotes the restriction to $Y_{\mathbf{G}}(\mathbf{U})$ of the canonical projection $\mathbf{G}/(\mathbf{U} \cap F(\mathbf{U})) \rightarrow \mathbf{G}/(\mathbf{P} \cap F(\mathbf{P}))$. The varieties $Y_{\mathbf{G}}(\mathbf{U})$ and $X_{\mathbf{G}}(\mathbf{P})$ are quasi-projective varieties and endowed with a left action of G by left multiplication. Furthermore, L acts on the right on $Y_{\mathbf{G}}(\mathbf{U})$ by right multiplication and π_L is isomorphic to the corresponding quotient map, so that it induces a G -equivariant isomorphism of varieties $Y_{\mathbf{G}}(\mathbf{U})/L \xrightarrow{\sim} X_{\mathbf{G}}(\mathbf{P})$.

2.1 Fixed points and endomorphisms

2.1.1 Description of fixed points. The claim in [34, Lemma 4.1] can be extended to parabolic Deligne-Lusztig varieties (cf. [13, Proposition 4.7] and [16, proof of Lemma 12.3] for a related result).

Lemma 2.1. *Let S be a finite solvable subgroup of $\text{Aut}(\mathbf{G})$ of order prime to p . Assume S commutes with the action of F and stabilises \mathbf{U} . Then the inclusion $\mathbf{G}^S \hookrightarrow \mathbf{G}$ induces an isomorphism*

$$Y_{\mathbf{G}^S}(\mathbf{U}^S) \xrightarrow{\sim} Y_{\mathbf{G}}(\mathbf{U})^S.$$

Proof. Denote by $\mathcal{L}_{\mathbf{G}} : \mathbf{G} \rightarrow \mathbf{G}, g \mapsto g^{-1}F(g)$ the Lang map. We have a commutative diagram

$$\begin{array}{ccccc}
\mathcal{L}_{\mathbf{G}^S}^{-1}(F(\mathbf{U}^S)) & \xrightarrow{\sim} & \mathcal{L}_{\mathbf{G}}^{-1}(F(\mathbf{U}))^S & \hookrightarrow & \mathcal{L}_{\mathbf{G}}^{-1}(F(\mathbf{U})) \\
\downarrow & & \downarrow & & \downarrow \alpha \\
Y_{\mathbf{G}^S}(\mathbf{U}^S) & \hookrightarrow & Y_{\mathbf{G}}(\mathbf{U})^S & \hookrightarrow & Y_{\mathbf{G}}(\mathbf{U})
\end{array}$$

Assume S is an ℓ -group for some prime ℓ . Let $y \in Y_{\mathbf{G}}(\mathbf{U})^S$ and $V = \alpha^{-1}(y)$, an affine space. The stratification of V by stabilisers as in §1.2 shows that $\ell \mid \sum_i (-1)^i \dim H_c^i(V \setminus V^S, \mathbb{F}_\ell)$. We deduce that $H_c^*(V^S, \mathbb{F}_\ell) \neq 0$, hence $V^S \neq \emptyset$. This proves the lemma when S is an ℓ -group.

We prove now the lemma by induction on $|S|$. There is a non-trivial normal ℓ -subgroup S_1 of S for some prime ℓ . The canonical map $Y_{\mathbf{G}^{S_1}}(\mathbf{U}^{S_1}) \rightarrow Y_{\mathbf{G}}(\mathbf{U})^{S_1}$ is an isomorphism. By induction, the lemma holds for \mathbf{G}^{S_1} with the action of S/S_1 , and we deduce that the lemma holds for (\mathbf{G}, S) . \square

Let Σ^+ be a monoid acting by automorphisms on L and acting on the right by equivalences of the étale site on the Deligne-Lusztig variety $Y_{\mathbf{G}}(\mathbf{U})$. We assume the action is compatible with the action of L and commutes with the action of G . We denote by Σ the group associated with Σ^+ and we put $Y = G \times (L \rtimes \Sigma)^{\text{opp}}$.

Given H a group, we denote by $\Delta H = \{(x, x^{-1}) \mid x \in H\}$ the corresponding diagonal subgroup of $H \times H^{\text{opp}}$.

Lemma 2.2. *Assume there exists a Σ^+ -stable p' -subgroup Z of L such that $\mathbf{L} = C_{\mathbf{G}}(Z)^\circ$. Then we have*

$$\bigcup_{h \in G} h(Y_{\mathbf{G}}(\mathbf{U})^{\Delta Z}) = G/G \cap \mathbf{U}$$

where G acts by left multiplication and $L \rtimes \Sigma$ by right multiplication preceded by a morphism $L \rtimes \Sigma \rightarrow N_G(L, G \cap \mathbf{U})$ that extends the identity on L .

Proof. By assumption on Z , the closed subvariety $R = \bigcup_{h \in G} h(Y_{\mathbf{G}}(\mathbf{U})^{\Delta Z})$ of $Y_{\mathbf{G}}(\mathbf{U})$ is stable by the action of Y^+ . Let $Q = \mathbf{U}^{\Delta Z} = \mathbf{U} \cap C_{\mathbf{G}}(Z)$. We have $\mathbf{L} \subset N_{\mathbf{G}}(Q)$. Since $\mathbf{U} \cap \mathbf{L} = \{1\}$ it follows that Q is finite hence $\mathbf{L} \subset C_{\mathbf{G}}(Q)$. Since $\mathbf{U} \cap C_{\mathbf{G}}(\mathbf{L}) = \mathbf{U} \cap C_{\mathbf{P}}(\mathbf{L}) = \{1\}$ we deduce that $Q = \{1\}$. Now by Lemma 2.1 the variety $Y_{\mathbf{G}}(\mathbf{U})^{\Delta Z}$ is the image of $\mathcal{L}_{C_{\mathbf{G}}(Z)}^{-1}(F(Q)) = C_G(Z)$ by the projection $\mathbf{G} \rightarrow \mathbf{G}/(\mathbf{U} \cap F(\mathbf{U}))$ and therefore we obtain

$$R = G(\mathbf{U} \cap F(\mathbf{U})) / (\mathbf{U} \cap F(\mathbf{U})) \simeq G/G \cap \mathbf{U}.$$

In particular the action of $L \rtimes \Sigma^+$ on R induces a G -equivariant action on $G/G \cap \mathbf{U}$.

Given H a subgroup of G , there is a group isomorphism $N_G(H)/H \xrightarrow{\sim} \text{End}_G(G/H)$ constructed as follows: an element $xH \in N_G(H)/H$ defines a G -equivariant map $yH \rightarrow yxH$. Conversely, the image of H by a G -equivariant map of G/H is in $N_G(H)/H$. Consequently the action of Y^+ on R yields a canonical group homomorphism $L \rtimes \Sigma \rightarrow N_G(G \cap \mathbf{U})/G \cap \mathbf{U}$.

Let $\sigma \in \Sigma$ and $y(G \cap \mathbf{U})$ be the image of σ by this morphism. Let $Q = \{(\sigma(l), l^{-1}) \mid l \in Z\}$. We claim that $y(\mathbf{U} \cap F(\mathbf{U})) \in Y_{\mathbf{G}}(\mathbf{U})^Q$. Indeed, $y^{-1}F(y) = 1$ hence $y(\mathbf{U} \cap F(\mathbf{U})) \in Y_{\mathbf{G}}(\mathbf{U})$. Furthermore, by definition of y , we have $yl y^{-1} \in$

$\sigma(l)(G \cap \mathbf{U})$ and therefore $\sigma(l)yl^{-1} \in y(G \cap \mathbf{U})$ for all $l \in L$. We deduce from Lemma 2.1 that y is the image of an element of $\mathcal{L}_{\mathbf{G}^Q}^{-1}(F(\mathbf{U}^Q))$, hence there exists $x \in \mathbf{G}^Q$ and $u \in \mathbf{U} \cap F(\mathbf{U})$ such that $y = xu$. By definition an element $x \in \mathbf{G}^Q$ acts on Z as σ . Consequently, $x^{-1}F(x)$ acts by $\sigma^{-1}F\sigma$, and in particular it normalises Z . Now $F(y) = y$ and $u, F(u) \in F(\mathbf{U})$ forces $x^{-1}F(x) \in F(\mathbf{U})$. Since $N_G(Z) \subset N_G(C_G(Z)^\circ) = N_G(\mathbf{L})$ we have $F(\mathbf{U}) \cap N_G(Z) = \{1\}$ and we deduce that $x \in N_G(L)$ and $u \in G \cap \mathbf{U}$. This proves that the image of $L \rtimes \Sigma \rightarrow N_G(G \cap \mathbf{U})/G \cap \mathbf{U}$ lies in $N_G(L, G \cap \mathbf{U})(G \cap \mathbf{U})/G \cap \mathbf{U}$, which is canonically isomorphic to $N_G(L, G \cap \mathbf{U})$ since $\mathbf{U} \cap N_G(L) = \mathbf{U} \cap N_G(\mathbf{L}) = \{1\}$. \square

Remark 2.3. (i) There is an obstruction for equivalences on the étale site of $Y_{\mathbf{G}}(\mathbf{U})$ to exist: if $\sigma \in \Sigma$ acts on L by conjugation by $\dot{v} \in N_G(L)$ then \dot{v} will necessarily normalise $G \cap \mathbf{U}$. This extends the case of F -stable unipotent radical \mathbf{U} , for which $Y_{\mathbf{G}}(\mathbf{U}) \simeq G/U$ and $N_G(L, U) = L$.

(ii) When $G \cap \mathbf{U}$ is trivial, this gives no obstruction for an element of the complex reflection group $N_G(L)/L$ lifts to an equivalence on the étale site of $Y_{\mathbf{G}}(\mathbf{U})$. Such equivalences have already been constructed in [7, 17] when \mathbf{U} is associated with a *minimal ζ -element*. Note that $G \cap \mathbf{U} = \{1\}$ for a larger class of elements.

(iii) The following lemma shows that one can always find a Z satisfying the assumptions in Lemma 2.4 providing that q is not too small. In the situation of the next section, Z will be a cyclic Sylow ℓ -subgroup of G .

The following lemma is a variation on a classical result (cf. [10, Lemma 13.17]).

Lemma 2.4. *Assume \mathbf{G} is connected. Let \mathbf{S} be an F -stable torus of \mathbf{G} and E a set of good prime numbers for \mathbf{G} , distinct from p , and prime to $|(Z(\mathbf{G})/Z(\mathbf{G})^\circ)^F|$. Let Z be the Hall E -subgroup of S .*

If for every irreducible factor Φ of the polynomial order of \mathbf{S} there is $\ell \in E$ such that $\ell \mid \Phi(q)$, then $C_{\mathbf{G}}(Z)^\circ = C_{\mathbf{G}}(\mathbf{S})$, and this is a Levi subgroup of \mathbf{G} .

Proof. Note that $C_{\mathbf{G}}(\mathbf{S})$ is a Levi subgroup by [16, Proposition 1.22].

Let $\mathbf{M} = C_{\mathbf{G}}(Z)^\circ$. This is a Levi subgroup of \mathbf{G} (cf. [10, Proposition 13.16.(ii)]) and $|Z|$ is prime to $|(Z(\mathbf{M})/Z(\mathbf{M})^\circ)^F|$ (cf. [10, Proposition 13.12.(iv)]). Consequently, $Z \subset Z(\mathbf{M})^\circ$. Let $\pi : \mathbf{M} \rightarrow \mathbf{M}/Z(\mathbf{M})^\circ$ be the quotient map. By [10, Lemma 13.17.(i)], the order of Z is prime to $[\pi(\mathbf{S})^F : \pi(S)]$, hence $\pi(\mathbf{S})^F$ has order prime to $|Z|$. On the other hand, the polynomial order of $\pi(\mathbf{S})$ divides that of \mathbf{S} , hence $\pi(\mathbf{S}) = 1$, so $\mathbf{S} \subset Z(\mathbf{M})^\circ$ and we are done. \square

2.1.2 Stable category and ℓ -ramification. Let us consider the closed Y -subvariety $Y_{\mathbf{G}}(\mathbf{U})_\ell$ of $Y_{\mathbf{G}}(\mathbf{U})$ defined by

$$Y_{\mathbf{G}}(\mathbf{U})_\ell = \{y \in Y_{\mathbf{G}}(\mathbf{U}) \mid \ell \text{ divides } |\text{Stab}_{G \times L^{\text{opp}}}(y)|\}.$$

By construction, the stabilisers in $G \times L^{\text{opp}}$ of points in $Y_{\mathbf{G}}(\mathbf{U}) \setminus Y_{\mathbf{G}}(\mathbf{U})_\ell$ are ℓ' -groups and $Y_{\mathbf{G}}(\mathbf{U})_\ell$ is the smallest variety such that this property holds.

Lemma 2.5. *The variety $Y_{\mathbf{G}}(\mathbf{U})_{\ell}$ decomposes as*

$$Y_{\mathbf{G}}(\mathbf{U})_{\ell} = \bigcup_{\substack{s \in L_{\ell} \setminus \{1\} \\ h \in G}} Y_{\mathbf{G}}(\mathbf{U})^{(h^{-1}s^{-1}h, s)} = \bigcup_{\substack{s \in L_{\ell} \setminus \{1\} \\ h \in G}} h(Y_{\mathbf{G}}(\mathbf{U}))^{(s^{-1}, s)}.$$

Proof. Let $y(\mathbf{U} \cap F(\mathbf{U})) \in Y_{\mathbf{G}}(\mathbf{U})$ and $(g, s) \in G \times L$ be an ℓ -element fixing y . Then $gys = yv$ for some $v \in \mathbf{U} \cap F(\mathbf{U})$, which we can write $y^{-1}gy = vs^{-1}$. Consequently $u^{-1}vs^{-1}u = u^{-1}y^{-1}gyu = F(y^{-1}gy) = F(v)s^{-1}$. Since $v, F(v) \in F(\mathbf{U})$ and $s^{-1} \in \mathbf{L} = F(\mathbf{L})$, we deduce that $u \in C_{\mathbf{G}}(s)$. From [16, Lemma 2.5] we deduce that $u \in F(\mathbf{U}) \cap C_{\mathbf{G}}(s)^{\circ}$. By Lang's theorem, there exists $x \in C_{\mathbf{G}}(s)^{\circ}$ such that $x^{-1}F(x) = u = y^{-1}F(y)$. With $h = x^{-1}y \in G$ we obtain $h^{-1}s^{-1}hys = yx^{-1}s^{-1}xs = y$. \square

Given A a self-injective algebra, we denote by $A\text{-stab}$ the stable category of A : it is the additive quotient $A\text{-stab} = A\text{-mod}/A\text{-proj}$. The canonical map $A\text{-stab} \rightarrow D^b(A\text{-mod})/A\text{-perf}$, where the right-hand term is the quotient as triangulated categories, is an equivalence of categories (Keller-Vossieck, Rickard). This provides $A\text{-stab}$ with a structure of triangulated category with translation functor Ω^{-1} .

From now on we assume that Σ^+ is cyclic, generated by σ . Then the group $\Upsilon = G \times (L \rtimes \Sigma)^{\text{opp}}$ is good and we have a complex $\tilde{\mathbf{R}}\Gamma_c(Y_{\mathbf{G}}(\mathbf{U})) \in \text{Ho}^b(k\Upsilon, k(G \times L^{\text{opp}}))$ whose terms are finitely generated ℓ -permutation $k(G \times L^{\text{opp}})$ -modules (cf. §1.2).

Given $\lambda \in k^{\times}$ and given M a finite-dimensional right $k\Sigma$ -module, we will denote by M_{λ} the generalised λ -eigenspace of σ (this is the image of $M \otimes_{k\Sigma} \widehat{k[\sigma]_{(\sigma-\lambda)}}$ in M). We put ${}_{\lambda}M = M_{\lambda^{-1}}$, the eigenspace of σ acting on M on the left by σ^{-1} .

Lemma 2.6. *Given $\lambda \in k^{\times}$ we have an isomorphism*

$$\tilde{\mathbf{R}}\Gamma_c(X_{\mathbf{G}}(\mathbf{P}), k)_{\lambda} \xrightarrow{\sim} \tilde{\mathbf{R}}\Gamma_c(Y_{\mathbf{G}}(\mathbf{U})_{\ell}/L, k)_{\lambda}$$

in $kG\text{-stab}$.

Proof. From Proposition 1.14 we deduce that the cone of the canonical map $f : \tilde{\mathbf{R}}\Gamma_c(Y_{\mathbf{G}}(\mathbf{U})) \rightarrow \tilde{\mathbf{R}}\Gamma_c(Y_{\mathbf{G}}(\mathbf{U})_{\ell})$ is homotopy equivalent to a bounded complex of projective $k(G \times L^{\text{opp}})$ -modules. As a consequence, $\text{cone}(f) \otimes_{kL} k$ is homotopy equivalent to a bounded complex of projective kG -modules. The map $f \otimes_{kL} k$ is a morphism of bounded complexes of finite-dimensional $k(G \times \Sigma^{\text{opp}})$ -modules, hence for any $\lambda \in k$ it induces a morphism of complexes of ℓ -permutation kG -modules

$$\tilde{\mathbf{R}}\Gamma_c(X_{\mathbf{G}}(\mathbf{P}))_{\lambda} \rightarrow \tilde{\mathbf{R}}\Gamma_c(Y_{\mathbf{G}}(\mathbf{U})_{\ell}/L)_{\lambda}$$

whose cone is homotopy equivalent to a bounded complex of finitely generated projective kG -modules. \square

2.2 The cyclic case

2.2.1 Centralisers of cyclic Sylow ℓ -subgroups. We start by describing the centralisers of Sylow ℓ -subgroups of G under the assumption that they are cyclic.

Lemma 2.7. *Assume \mathbf{G} is connected and G has a cyclic Sylow ℓ -subgroup S_ℓ . Let $\mathbf{L} = C_{\mathbf{G}}(S_\ell)^\circ$. Then*

- (i) \mathbf{L} is an F -stable Levi subgroup of \mathbf{G} and $S_\ell \subset Z(\mathbf{L})^\circ$.
- (ii) For any non-trivial element $s \in S_\ell$, we have $C_{\mathbf{G}}(s)^\circ = \mathbf{L}$ and $C_G(s) = L$, hence any two distinct Sylow ℓ -subgroups of G have trivial intersection.
- (iii) $N_G(S_\ell) = N_G(L) = N_G(\mathbf{L})$.

Proof. Let us first consider the case where \mathbf{G} is simple. Let \mathbf{G}_{sc} be the universal cover of \mathbf{G} . We denote by $\mathbf{O}_{\mathbf{G},F}(x) = x^N \prod_e \Phi_e(x)^{a(e)}$ the "very twisted" polynomial order of \mathbf{G} : we have $|G| = \mathbf{O}_{\mathbf{G},F}(q^\varepsilon)$ where $\varepsilon = 2$ if \mathbf{G} has type 2B_2 , 2F_4 or 2G_2 , and $\varepsilon = 1$ otherwise. Let d be the order of q^ε modulo ℓ . With S_ℓ being cyclic, we claim that:

- the multiplicity of Φ_d as a divisor of $\mathbf{O}_{\mathbf{G},F}(x)$ is 1;
- ℓ is odd;
- $\ell \nmid |Z(\mathbf{G}_{\text{sc}})^F|$. In particular, both $Z(\mathbf{G})^F$ and $Z(\mathbf{G}^*)^F$ are ℓ' -groups;
- $\Phi_{d\ell^r} \nmid \mathbf{O}_{\mathbf{G},F}(x)$ for $r \geq 1$;
- ℓ is good for \mathbf{G} .

We have $\ell \neq 2$ by [24, Theorem 4.10.5(a)]. Assume now ℓ is odd. If ℓ divides $|Z(\mathbf{G}_{\text{sc}})^F|$, then W^F has non-cyclic Sylow ℓ -subgroups (cf. [24, Table 2.2]), unless \mathbf{G} has type A: in that case, if \mathbf{T} is a quasi-split torus of \mathbf{G} , then $N_G(\mathbf{T})$ has non-abelian Sylow ℓ -subgroups. We deduce that the multiplicity of Φ_d as a divisor of $\mathbf{O}_{\mathbf{G},F}(x)$ is 1 [24, Theorems 4.10.2 and 4.10.3] and that G_{sc} has cyclic Sylow ℓ -subgroups. The last two properties are easily checked by inspection. Note that conversely, if the multiplicity of Φ_d as a divisor of $\mathbf{O}_{\mathbf{G},F}(x)$ is 1, then G has cyclic Sylow ℓ -subgroups [24, Theorem 4.10.3]. Note also that by descents of scalars, the result remains true if $\mathbf{G} \simeq \mathbf{G}_1 \times \cdots \times \mathbf{G}_r$ is a product of simple groups permuted cyclically by F since in that case $\mathbf{G}^F \simeq \mathbf{G}_1^{F^r}$.

Now any connected reductive group \mathbf{G} is a product of its minimal F -stable semisimple normal connected subgroups and its connected center. Moreover, the intersection of any two such subgroups is finite and central, and the conditions on ℓ given above force S_ℓ to lie in only one component (since $Z(\mathbf{H})$ is a quotient of $Z(\mathbf{H}_{\text{sc}})$ for any semisimple group \mathbf{H}). We may therefore assume that (\mathbf{G}, F) is a product of simple groups permuted cyclically by F .

Let $\mathbf{L} = C_{\mathbf{G}}(S_\ell)^\circ$ and $s \in S_\ell$. We fix a pair (\mathbf{G}^*, F^*) dual to (\mathbf{G}, F) . By [10, Proposition 3.16.(ii)], $C_{\mathbf{G}}(s)^\circ$ is a Levi subgroup, which proves (i). By [10, Proposition 3.16.(i)], the group $(C_{\mathbf{G}}(s)/C_{\mathbf{G}}(s)^\circ)^F$ is trivial since it is both an ℓ -group and a subquotient of $Z(\mathbf{G}^*)^F$ which is an ℓ' -group (it is isomorphic to a quotient of $Z(\mathbf{G}_{\text{sc}})$). This shows that $(C_{\mathbf{G}}(s)^\circ)^F = C_G(s)$. In particular, $C_{\mathbf{G}}(s)^\circ$ contains s . By [10, Proposition 13.12.(ii)], its connected center $Z(C_{\mathbf{G}}(s)^\circ)^\circ$ also

contains s . The (usual) polynomial order of (\mathbf{G}, F) has a unique simple factor over $\mathbb{Z}[x]$ (or $\mathbb{Z}[\sqrt{p}][x]$ for Ree and Suzuki groups) that vanishes modulo ℓ at $x = q$. Consequently, $\ell \nmid [G : (Z(C_{\mathbf{G}}(s)^\circ)^\circ)^F]$, hence $S_\ell \subset Z(C_{\mathbf{G}}(s)^\circ)^\circ$ and therefore $C_{\mathbf{G}}(s)^\circ = C_{\mathbf{G}}(S_\ell)^\circ$.

The last part of (ii) follows from the inclusions $N_G(\mathbf{L}) \subset N_G(L) \subset N_G(S_\ell) \subset N_G(Q) \subset N_G(C_G(Q)^\circ) = N_G(\mathbf{L})$ given any non-trivial subgroup Q of S_ℓ . \square

Remark 2.8. Note that $C_{\mathbf{G}}(S_\ell)$ is not always connected. For example, take $\mathbf{G} = \mathrm{PGL}_\ell$ and assume F defines a split structure over \mathbb{F}_q . Let d be the order of q in \mathbb{F}_ℓ^\times . Assume $d > 1$ and $\ell^2 \nmid \Phi_d(q)$. Then, a Sylow ℓ -subgroup S_ℓ of G has order ℓ and $C_{\mathbf{G}}(S_\ell)/C_{\mathbf{G}}(S_\ell)^\circ$ has order ℓ .

Let us assume now that \mathbf{G} is a connected reductive group such that G has a cyclic Sylow ℓ -subgroup S_ℓ . We take $\mathbf{L} = C_{\mathbf{G}}(S_\ell)^\circ$. It is an F -stable Levi subgroup of \mathbf{G} (cf. Lemma 2.7). Given s a non-trivial element of S_ℓ , we have $C_G(s) = L$ by Lemma 2.7.(ii). We deduce from Lemmas 2.2 and 2.5 that there exists a group homomorphism $L \rtimes \Sigma \rightarrow N_G(L, G \cap \mathbf{U})$ such that

$$Y_{\mathbf{G}}(\mathbf{U})_\ell \simeq \mathrm{Res}_{G \times (L \rtimes \Sigma)^{\mathrm{opp}}}^{G \times N_G(L, G \cap \mathbf{U})^{\mathrm{opp}}} G/G \cap \mathbf{U}.$$

Let N_Σ be the subgroup of $N_G(L)$ generated by the image of $L \rtimes \Sigma$. Let e be the order of the cyclic group N_Σ/L . Given λ an e -th root of unity in k^\times , we denote by k_λ the one-dimensional representation of N_Σ on which the image of σ acts by λ and N_Σ acts trivially.

Proposition 2.9. *Assume \mathbf{G} is connected and G has a cyclic Sylow ℓ -subgroup S_ℓ . Let $\mathbf{L} = C_{\mathbf{G}}(S_\ell)^\circ$. Given $\lambda \in k^\times$, we have*

$$\tilde{\mathrm{R}}\Gamma_c(\mathbf{X}_{\mathbf{G}}(\mathbf{P}), k)_\lambda \simeq \begin{cases} \mathrm{Ind}_{N_\Sigma}^G k_\lambda & \text{if } \lambda^e = 1; \\ 0 & \text{otherwise} \end{cases}$$

in kG -stab.

Proof. By Lemma 2.6 and the description of $Y_{\mathbf{G}}(\mathbf{U})_\ell$, we have $\tilde{\mathrm{R}}\Gamma_c(\mathbf{X}_{\mathbf{G}}(\mathbf{P}), k)_\lambda = 0$ in kG -stab if $\lambda^e \neq 1$. Otherwise we have

$$\tilde{\mathrm{R}}\Gamma_c(\mathbf{X}_{\mathbf{G}}(\mathbf{P}), k)_\lambda \simeq \mathrm{Ind}_{N_\Sigma \times (G \cap \mathbf{U})}^G \mathrm{Res}_{N_\Sigma \times (G \cap \mathbf{U})}^{N_\Sigma} k_\lambda$$

in kG -stab. Now by Lemma 2.7.(iii) we have $N_G(S_\ell) \cap \mathbf{U} = N_G(\mathbf{L}) \cap \mathbf{U} = \{1\}$, hence $S_\ell \cap {}^u(S_\ell) = \{1\}$ for any non-trivial $u \in G \cap \mathbf{U}$ (cf. Lemma 2.7.(ii)). It follows from the Mackey formula that $\mathrm{Ind}_{N_\Sigma}^{N_\Sigma \times (G \cap \mathbf{U})} k_\lambda \simeq \mathrm{Res}_{N_\Sigma \times (G \cap \mathbf{U})}^{N_\Sigma} k_\lambda$ in $k(N_\Sigma \times (G \cap \mathbf{U}))$ -stab. \square

Remark 2.10. Note that this result holds if we replace the condition that S_ℓ is a cyclic Sylow ℓ -subgroup of G by the following: S_ℓ is a Sylow ℓ -subgroup of L and for all non-trivial ℓ -element $s \in L$ we have $C_{\mathbf{G}}(s)^\circ = \mathbf{L}$.

2.2.2 Endomorphism associated with F . We can construct a specific endomorphism σ of $Y_{\mathbf{G}}(\mathbf{U})$ associated with the Frobenius. There exists $\dot{w} \in N_{\mathbf{G}}(\mathbf{L})$

such that ${}^w F(\mathbf{L}, \mathbf{P}) = (\mathbf{L}, \mathbf{P})$. Let $\delta \geq 1$ be minimal such that ${}^w F$ induces a split structure on \mathbf{L} . Let us consider $\dot{v} = {}^w F(\dot{w}) \cdots F^{\delta-1}(\dot{w})$ and define $\sigma = \dot{v} F^\delta = ({}^w F)^\delta$. We can choose \dot{w} such that \dot{v} is fixed by F . We let σ act on $Y_{\mathbf{G}}(\mathbf{U})$ by $\sigma(g) = F^\delta(g)\dot{v}^{-1}$. It is compatible with the action of $G \times L^{\text{opp}}$, where σ acts on L by conjugation by \dot{v}^{-1} .

Corollary 2.11. *Assume there is a cyclic Sylow ℓ -subgroup S_ℓ of G such that $\mathbf{L} = C_{\mathbf{G}}(S_\ell)^\circ$. Assume furthermore that $v = wF(w) \cdots F^{\delta-1}(w)$ generates $N_G(L)/L$. Let $m \in \{0, \dots, e-1\}$. If ${}_{q^{m\delta}} \tilde{\text{R}}\Gamma_c(\mathbf{X}_{\mathbf{G}}(\mathbf{P}), k)$ is quasi-isomorphic to a module concentrated in degree d with no projective indecomposable summand, then there exists an isomorphism of kG -modules*

$${}_{q^{m\delta}} \text{H}_c^d(\mathbf{X}_{\mathbf{G}}(\mathbf{P}), k) \simeq \Omega^{2m-d} k.$$

Proof. The endomorphism σ induces a split \mathbb{F}_{q^δ} -structure on the torus $Z(\mathbf{L})^\circ$, and therefore \dot{v} acts on S_ℓ by raising any element to the power of $q^{-\delta}$. In particular, since v has order e , the image of q^δ in k is a primitive e -th root of unity. We deduce that the one-dimensional representation of $N_G(L)$ on which v acts by $q^{m\delta}$ satisfies $k_{q^{m\delta}} \simeq \Omega^{-2m} k$ in the category of $kN_G(L)$ -modules (see Example 3.3 below for more details). We deduce from Proposition 2.9 that ${}_{q^{m\delta}} \tilde{\text{R}}\Gamma_c(\mathbf{X}_{\mathbf{G}}(\mathbf{P})) \simeq \Omega^{2m} \text{Ind}_{N_G(L)}^G k$ in the stable category of kG -modules.

Since the distinct Sylow ℓ -subgroups of G have trivial intersection (Lemma 2.7.(ii)), we have $\text{Ind}_{N_G(L)}^G k = \text{Ind}_{N_G(S_\ell)}^G k \simeq k$ in the stable category. The result follows then from the fact that two kG -modules that have no projective indecomposable summand are isomorphic in the stable category if and only if they are isomorphic as kG -modules. \square

Remark 2.12. This corollary generalises to the eigenspace of an operator $D_{\dot{v}}$ (as defined in [7, 17]) whenever $N_G(L)$ is generated by L and \dot{v} .

3 Brauer trees

3.1 Walking around Brauer trees

Let ℓ be a prime number, \mathcal{O} be the ring of integers of a finite extension K of \mathbb{Q}_ℓ and let k be its residue field. We will assume that K is large enough for all the finite groups encountered. Let H be a finite group and $b\mathcal{O}H$ be a block of $\mathcal{O}H$. If the defect D of the block is a non-trivial cyclic group, then the category of $b\mathcal{O}H$ -modules can be described by a combinatorial object, the *Brauer tree* Γ of the block [20, Chapter VII]:

- The set of vertices \mathcal{V} of Γ consists of the ordinary non-exceptional characters in the block and the sum χ_{exc} of the exceptional characters in the block. The number of non-exceptional (resp. exceptional) characters will be denoted by e (resp. m). The integer m will also be referred to as the *multiplicity* of the exceptional vertex.

- There is an edge $\chi - \chi'$ in the Brauer tree if there exists a projective indecomposable $b\mathcal{O}H$ -module with character $\chi + \chi'$ for $\chi \neq \chi'$ in \mathcal{V} .
- There is a cyclic ordering of the edges containing any given vertex, defining a planar embedding of the tree.

The planar embedded Brauer tree determines the category of $b\mathcal{O}H$ -modules up to Morita equivalence.

Let us first describe the structure of the projective indecomposable modules in the block. Let P be such a module, and assume that its character is the sum of two non-exceptional characters χ and χ' as in the following picture:

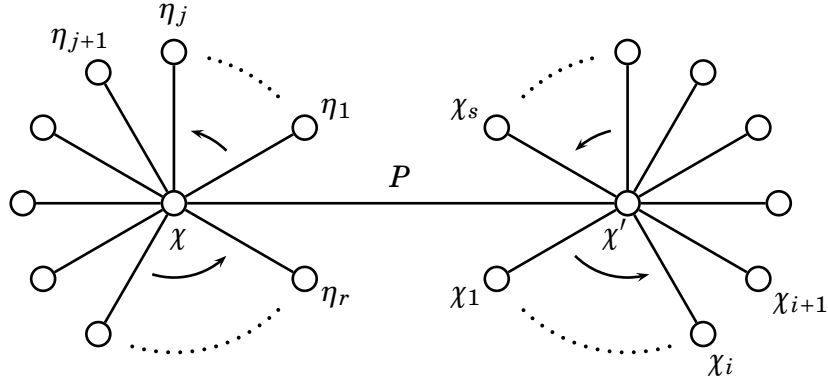

Denote by S_j (resp. T_i) the simple kH -module whose projective cover has character $\chi + \eta_j$ (resp. $\chi' + \chi_i$) over K and let $\bar{P} = P \otimes_{\mathcal{O}} k$. Assume $\chi, \chi' \neq \chi_{\text{exc}}$. The module $\text{rad}\bar{P}/\text{soc}\bar{P}$ is the direct sum of two uniserial modules with composition series S_1, \dots, S_r and T_1, \dots, T_s so that \bar{P} has the following structure:

$$\begin{array}{cc}
 & S \\
 S_1 & T_1 \\
 \vdots & \vdots \\
 S_r & T_s \\
 & S
 \end{array} \tag{3.1}$$

In addition, the unique quotient U (resp. submodule V) of \bar{P} which has S, S_1, \dots, S_r (resp. T_1, \dots, T_s, S) as a composition series can be lifted to an \mathcal{O} -free $\mathcal{O}H$ -module of character χ (resp. χ'). The structure of $\bar{P} = P_U$ yields $\Omega U \simeq V$. Now V is in turn a quotient of a projective cover of T_1 , so that $\Omega V = \Omega^2 U$ is a uniserial module with character χ_1 . By iterating with process, we obtain a sequence $(\Omega^i U)_{i \geq 0}$ of uniserial modules, each of which lifts to an \mathcal{O} -free $\mathcal{O}H$ -module yielding an irreducible ordinary character (or the exceptional character) in the block. This sequence is called the *Green walk* starting at U [25]. It is periodic of period $2e$ and can be easily read off from the planar embedded tree.

Remark 3.2. When $\chi = \chi_{\text{exc}}$, the structure of \bar{P} described above is slightly different: one should turn around the exceptional node as many times as the multiplicity of the exceptional vertex. This amounts to repeating m times the composition series S, S_1, \dots, S_r in U .

Example 3.3. We close this section with the example of a star. Assume that $H = D \rtimes E$ where D is a cyclic ℓ -group and E is an ℓ' -subgroup of $\text{Aut}(D)$. Fix a generator x of E of order e . Then x acts on D by raising the elements to some power d . By Hensel's Lemma there exists a primitive e -th root of unity $\zeta \in \mathcal{O}$ congruent to d . Denote by χ_1, \dots, χ_e the one-dimensional characters of H over K such that $\chi_i(x) = \zeta^i$ and denote by $S_1, \dots, S_e = k$ the associated kH -modules. The exceptional characters are the characters of H of dimension > 1 . The planar embedded Brauer tree of the principal ℓ -block of H is given by the following picture:

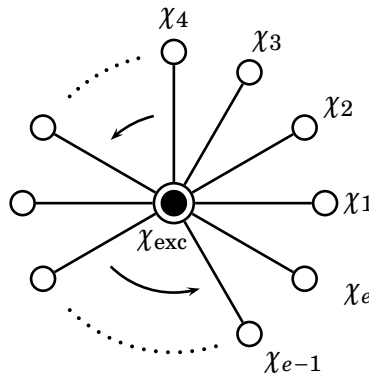

In this particular case, the syzygies of a module S_j satisfy $\Omega^{2i} S_j = S_{j+i}$ and Green's walk from S_j yields the sequence $\chi_j, \chi_{exc}, \chi_{j+1}, \chi_{exc}, \chi_{j+2}, \dots$

3.2 Brauer trees of the principal Φ_h -block

When d is the Coxeter number, Hiß, Lübeck and Malle have formulated in [29] a conjecture describing the Brauer tree of the principal Φ_d -block. In this section we shall combine the results of [18] and §2 to obtain a general proof of the conjecture. This includes the determination of the previously unknown planar embedded tree for groups of type 2F_4 , E_7 and E_8 . As a byproduct we obtain a proof of the geometric version of Broué's conjecture for varieties associated with Coxeter elements when p is good (see Theorem 3.6).

In this section, \mathbf{G} is a connected reductive group, \mathbf{T} is a maximal F -stable torus of \mathbf{G} , $\Phi = \Phi(\mathbf{G}, \mathbf{T})$ is the corresponding root system and $W = N_{\mathbf{G}}(\mathbf{T})/\mathbf{T}$ its Weyl group. We put $\phi = q^{-1}F$, a linear transformation of $V = Y(\mathbf{T}) \otimes \mathbb{C}$. Throughout this section we will assume that V is irreducible for the action of $W \rtimes \langle \phi \rangle$. In particular, \mathbf{G} decomposes as an almost product of simple groups that are permuted cyclically by F .

3.2.1 Previous results. We assume \mathbf{T} is a *Coxeter torus*. This means that ϕ has an eigenvalue of order the Coxeter number h , where h is the maximal possible order of an eigenvalue of $y\phi$ in V for $y \in W$. In that case there exists $w \in W$ and a $w\phi$ -stable basis Δ of Φ such that each orbit of Φ under $w\phi$ contains exactly one positive root α such that $\phi(\alpha) < 0$ (cf. [37, Section 7]). Furthermore, the following properties are satisfied:

- the $\exp(2\pi i/h)$ -eigenspace of ϕ in V is maximal and it is a line which intersects trivially any reflecting hyperplane. As a consequence, the order of $|G|$, which is a polynomial in q , has Φ_h as a simple factor;
- if δ denotes the order of $w\phi$ as an endomorphism of V , then $C_W(F)$ is a cyclic group of order $h_0 = h/\delta$ generated by $v = wF(w)\cdots F^{\delta-1}(w)$.

The basis Δ defines a wF -stable Borel subgroup \mathbf{B} containing \mathbf{T} . The corresponding Deligne-Lusztig variety $X_G(\mathbf{B})$ will be referred to as a *Coxeter variety* and we will denote by r its dimension.

We assume the image of q in k is a primitive h -root of 1. If \mathbf{G} has type 2B_2 (resp. 2F_4 , resp. 2G_2) we assume in addition that $\ell \mid q^2 - q\sqrt{2} + 1$ (resp. $\ell \mid q^4 - q^3\sqrt{2} + q^2 - q\sqrt{2} + 1$, resp. $\ell \mid q^2 - q\sqrt{3} + 1$). The Sylow ℓ -subgroups of G are cyclic (cf. proof of Lemma 2.7) and \mathbf{T} is the centraliser of one of them.

Let us recall some results of Lusztig [31] on the cohomology of Coxeter varieties. We fix an F -stable lift \dot{v} of v in $N_G(\mathbf{T})$. The Frobenius endomorphism $\sigma = \dot{v}F^\delta$ acts (on the left) semi-simply on $H_c^i(X_G(\mathbf{B}), K)$ and each eigenvalue is equal to $q^{j\delta}$ in k for a unique $j \in \{0, \dots, h_0 - 1\}$. The eigenspaces of σ are mutually disjoint irreducible KG -modules and their characters $\{\chi_0, \dots, \chi_{h_0-1}\}$ are the non-exceptional characters in the block. Moreover, if we fix a square root of q^δ in K , then each eigenvalue of σ can be written as $\zeta q^{im\delta/2}$ for some integer i and some root of unity ζ which depends only on the Harish-Chandra series of the associated eigenspace. For a given ζ , the contribution of the corresponding Harish-Chandra series to the cohomology of $X_G(\mathbf{B})$ is given by

$$\begin{array}{c|c|c|c} H_c^r(X_G(\mathbf{B}), K) & H_c^{r+1}(X_G(\mathbf{B}), K) & \cdots & H_c^{r+M_\zeta-m_\zeta}(X_G(\mathbf{B}), K) \\ \hline \chi_{m_\zeta} & \chi_{m_\zeta+1} & \cdots & \chi_{M_\zeta} \end{array}$$

for some $M_\zeta \geq m_\zeta$. Furthermore, according to [23], the following tree

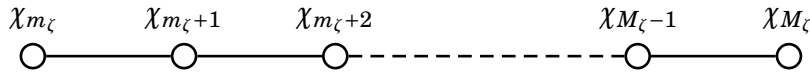

is a subtree of the Brauer tree of the principal ℓ -block. The missing vertex is the exceptional one: it corresponds to the non-unipotent characters in the block. By [19], the missing edges are labelled by the cuspidal kG -modules in the block. With this notation, the conjecture of Hiß-Lübeck-Malle [29] can be stated as follows:

Conjecture 3.4 (Hiß-Lübeck-Malle). *Let Γ be the Brauer tree of the principal Φ_h -block. Then*

- (i) *(Shape of the tree) The vertices labelled by χ_{m_ζ} are the only nodes connected to the exceptional node in Γ .*
- (ii) *(Planar embedding) The vertices labelled by χ_{m_ζ} are ordered around the exceptional vertex according to increasing values of m_ζ .*

Assertion (i) is known to hold for any group but E_7 and E_8 . The proof relies on a case-by-case analysis, combining results of Fong-Srinivasan for classical

groups [22], Hiß for Ree groups [27], Hiß-Lübeck-Malle for groups of type E_6 [29] and Hiß-Lübeck for groups of type F_4 and 2E_6 [28]. The planar embedding was not known for groups of type 2G_2 , 2F_4 , F_4 , E_7 and E_8 . The first two cases were recently settled in [19] (under the assumption $p \neq 2, 3$ in type 2F_4), but the other cases remained unsolved. Our main result gives an unconditional proof of this conjecture:

Theorem 3.5. *The conjecture of Hiß-Lübeck-Malle holds.*

From [18, Theorems 3.9 and 3.11], we deduce that the geometric version of Broué's conjecture holds for the principal Φ_h -block whenever p is good. Moreover, in that case the contribution to the block of the cohomology of $Y_{\mathbf{G}}(\mathbf{U})$ with coefficients in \mathcal{O} is torsion-free.

Theorem 3.6. *Assume p is good. Then there is a bounded complex C of finitely generated ℓ -permutation $\mathcal{O}(G \times N_G(T)^{\text{opp}})$ -modules such that $\text{Res}_{G \times (L \times \Sigma)^{\text{opp}}}^{G \times N_G(T)^{\text{opp}}}(C \otimes_{\mathcal{O}} k)$ is isomorphic to $\tilde{\text{R}}\Gamma_c(Y_{\mathbf{G}}(\mathbf{U}), k)$ in $\text{Ho}^b(k(G \times (T \rtimes \Sigma)^{\text{opp}}))$ and such that C induces a perverse Rickard equivalence between the principal blocks of $\mathcal{O}G$ and $\mathcal{O}N_G(T)$.*

3.2.2 Determination of the Brauer trees. We shall now give a proof of the conjecture of Hiß-Lübeck-Malle. For that purpose, we shall use Corollary 2.11 and the results in [18] to compute the syzygies of the trivial module. By [19, Proposition 2.12], the generalised $q^{m_{\zeta}\delta}$ -eigenspace of $\sigma = \iota F^{\delta}$ on $\tilde{\text{R}}\Gamma_c(X_{\mathbf{G}}(\mathbf{B}), k)$ is quasi-isomorphic to a complex concentrated in degree r . Moreover, it has no projective indecomposable summand since it can be lifted up to an \mathcal{O} -free $\mathcal{O}G$ -module of character $\chi_{m_{\zeta}}$. Consequently we can apply Corollary 2.11 to obtain the following isomorphism of kG -modules

$$q^{m_{\zeta}\delta} H_c^r(X_{\mathbf{G}}(\mathbf{B}), k) \simeq \Omega^{2m_{\zeta}-r} k. \quad (3.7)$$

The principal ℓ -block is self-dual, the dual of the character $\chi_{m_{\zeta}}$ is $\chi_{m_{\zeta^{-1}}}$ and the dual of the module $\Omega^{2m_{\zeta}-r} k$ is $\Omega^{r-2m_{\zeta}} k$. In particular, if we apply (3.7) to ζ and ζ^{-1} we deduce that both $\Omega^{2m_{\zeta}-r} k$ and $\Omega^{r-2m_{\zeta^{-1}}} k$ can be lifted up to \mathcal{O} -free $\mathcal{O}G$ -modules with character $\chi_{m_{\zeta}}$. In order to compare the positions of these two modules in Green's walk we will use the following relation:

Lemma 3.8. *With the notation in §3.2.1, we have $m_{\zeta^{-1}} + M_{\zeta} \equiv r \pmod{h}$.*

Proof. Recall from [31, Table 7.1] that the eigenvalues of σ on the series associated with ζ are $\zeta q^{a\delta/2}, \zeta q^{\delta(a/2+1)}, \dots, \zeta q^{\delta(a/2+M_{\zeta}-m_{\zeta})}$ for some integer a . Moreover, the interval $\{a/2, \dots, a/2 + M_{\zeta} - m_{\zeta}\}$ is centred at $r/2$, so that $a + M_{\zeta} - m_{\zeta} = r$. Finally, we observe that a does not change if we replace ζ by its conjugate ζ^{-1} . Since $\zeta q^{a\delta/2}$ (resp. $\zeta^{-1} q^{a\delta/2}$) is equal in k to $q^{\delta m_{\zeta}}$ (resp. $q^{\delta m_{\zeta^{-1}}}$) and q^{δ} has order h modulo ℓ , we deduce that $a \equiv m_{\zeta} + m_{\zeta^{-1}} \pmod{h}$ and we conclude the proof using the previous equality. \square

Let $1 = \zeta_1, \dots, \zeta_s$ be the roots of unity that appear in the eigenvalues of $\sigma = \psi F^\delta$ on $H_c^\bullet(X_G(\mathbf{B}), K)$, ordered according to increasing value of m_ζ . From the lemma we compute $r - 2m_{\zeta^{-1}} - (2m_\zeta - r) \equiv 2(M_\zeta - m_\zeta) \pmod{2h}$ and $2m_{\zeta_{i+1}} - r - (r - 2m_{\zeta_i^{-1}}) \equiv 2 \pmod{2h}$ since $m_{\zeta_{i+1}} = M_{\zeta_i} + 1$ and $m_{\zeta_1} = r$. We deduce that Green's walk starting from the trivial module satisfies the following pattern

$$1_G \xrightarrow{+r} \chi_{m_{\zeta_1}} \xrightarrow{+2} \chi_{m_{\zeta_2}} \xrightarrow{+2(M_{\zeta_2} - m_{\zeta_2})} \chi_{m_{\zeta_2}} \xrightarrow{+2} \chi_{m_{\zeta_3}} \xrightarrow{+2(M_{\zeta_3} - m_{\zeta_3})} \dots \quad (3.9)$$

The following consequence will be helpful in determining the Brauer tree:

Lemma 3.10. *During Green's walk from k to $\Omega^{2h}k \simeq k$, the first occurrence of a character in a Harish-Chandra series associated with $\zeta \neq 1$ is χ_{m_ζ} .*

Proof. If χ_{m_ζ} is not the first character of the ζ -series encountered in a Green walk, then between any two occurrences of χ_{m_ζ} , at least one character from a different series must occur. Let $\xi \neq \zeta$ be the corresponding root of unity. By the results recalled in §3.2.1, every character in the block lying in this series will also occur. In particular, since the Brauer tree is a tree, any occurrence of χ_{m_ξ} will be found between these two occurrences of χ_{m_ζ} , which contradicts (3.9). \square

We claim that this information together with the results in §3.2.1 is enough to determine the Brauer tree. We will only examine the case of the ζ_1 -series (the principal series) and the ζ_2 -series as the other cases are similar. Since the distance between $\chi_{m_{\zeta_1}} = \text{St}_G$ and $\chi_0 = 1_G$ is equal to r , which is also the length of the principal series, a character is connected to the principal series in the Brauer tree if and only if it is connected to the Steinberg character:

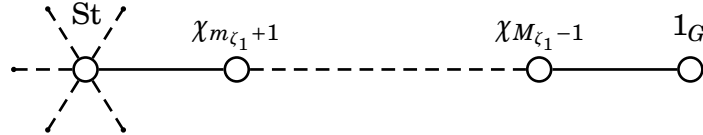

By (3.9), we know that $\chi_{m_{\zeta_2}}$ is two steps further the first occurrence of the Steinberg. If the $(r + 2)$ -th vertex χ in the walk is not the exceptional one then we are in the following situation

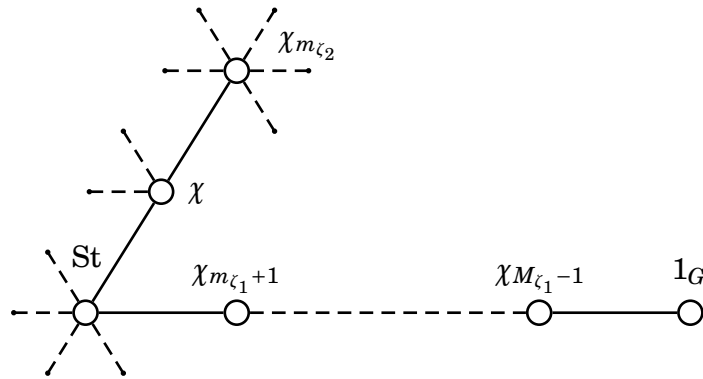

Here χ is a non-exceptional character lying in a Harish-Chandra series associated with some root of unity ζ . But by parity χ cannot be equal to χ_{m_ζ} , which contradicts Lemma 3.10.

Therefore $\chi_{m_{\zeta_2}}$ is connected to the exceptional node and the Brauer tree has the following shape:

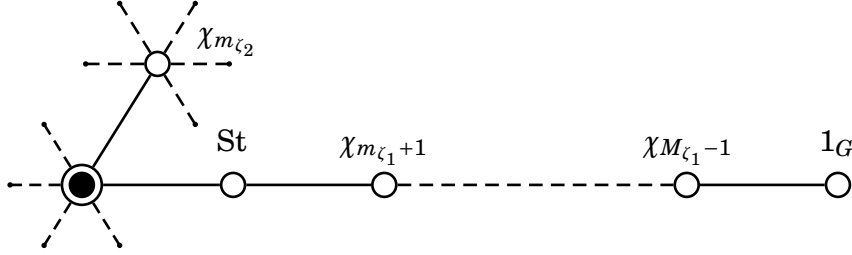

Finally, since the branch corresponding to the ζ_2 -series has $M_{\zeta_2} - m_{\zeta_2}$ edges, we deduce from (3.9) that the Brauer tree has the following shape

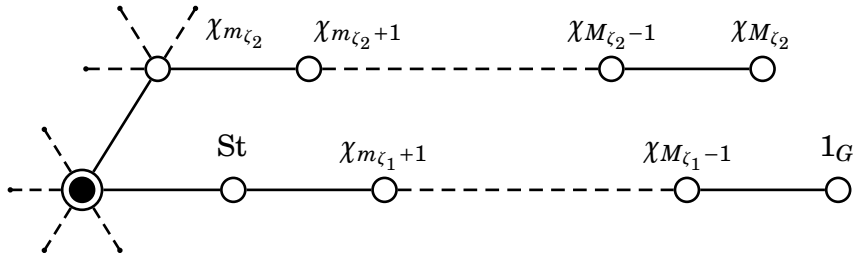

It remains to iterate the process to obtain the planar embedded Brauer tree predicted by the conjecture of Hiß-Lübeck-Malle. This completes the proof of Theorem 3.5.

3.3 Non-unipotent ℓ -blocks

We keep the assumption on ℓ given in §3.2 and we fix a pair $(\mathbf{G}^*, \mathbf{T}^*, F^*)$ dual to $(\mathbf{G}, \mathbf{T}, F)$. Throughout this section, we will assume that \mathbf{G} is adjoint, so that the centraliser of any semisimple element in \mathbf{G}^* is connected. Let $s \in G^*$ be a semisimple ℓ' -element. Following [8], we denote by $\mathcal{E}_\ell(G, (s))$ the union of rational series $\mathcal{E}(G, (st))$ where t runs over a set of representatives of conjugacy classes of semisimple ℓ -elements in $C_{G^*}(s)$. By [8, Théorème 2.2] and [9, §3.2], it is a union of blocks that have either trivial or full defect. Furthermore, if $\mathcal{E}_\ell(G, (s))$ contains a non-trivial block, then s must be conjugate to an element of $C_{G^*}(S_\ell^*) = T^*$, where S_ℓ^* denotes the Sylow ℓ -subgroup of $T^* = (\mathbf{T}^*)^{F^*}$. Note that by [8, Théorème 3.2], the principal block is the only unipotent block with non-trivial defect.

We assume now that s is an ℓ' -element of T^* such that $\mathcal{E}_\ell(G, (s))$ contains a non-trivial block b . If there is a proper F^* -stable Levi subgroup \mathbf{L}^* of \mathbf{G}^* such

that $C_{\mathbf{G}^*}(s) \subset \mathbf{L}^*$, then by [3, Théorème B'] the block b is Morita equivalent to an ℓ -block b_s in $\mathcal{E}_\ell(L, (s))$. Now $[\mathbf{L}^*, \mathbf{L}^*]$ is adjoint and two cases can arise: if $\ell \nmid |Z(\mathbf{L}^*)^F|$ then $[\mathbf{L}^*, \mathbf{L}^*]$ has a minimal F -stable connected normal subgroup that contains s . It is also the unique one whose Coxeter number is h . If S_ℓ^* is central in L^* then b_s is isomorphic to a unipotent block of L and the results in §3.2 apply and the Brauer tree of the block is known by induction on the rank of \mathbf{G} .

If such a proper Levi subgroup \mathbf{L}^* does not exist then s and by extension b are said to be *isolated*. Under our assumptions on ℓ , very few isolated blocks with non-trivial defect can appear in exceptional adjoint groups:

Lemma 3.11. *Let (\mathbf{G}, F) be an exceptional adjoint simple group not of type G_2 . Under the assumptions on ℓ in §3.2, any isolated ℓ -block has trivial defect.*

Proof. Let $\mathbf{M}^* = C_{\mathbf{G}^*}(s)$. It is a connected reductive subgroup of \mathbf{G}^* . If ℓ does not divide $[\mathbf{M}^*, \mathbf{M}^*]^{F^*}$, then S_ℓ^* must be central in \mathbf{M}^* since $\mathbf{M}^* = [\mathbf{M}^*, \mathbf{M}^*]Z(\mathbf{M}^*)$. Therefore $\mathbf{M}^* \subset C_{\mathbf{G}^*}(S_\ell^*) = \mathbf{T}^*$. Consequently ℓ divides the order of $[\mathbf{M}^*, \mathbf{M}^*]^{F^*}$ whenever s is isolated.

Recall that the conjugacy classes of isolated elements are parametrised by roots in the extended Dynkin diagram (given for example in [2]). With the assumption on §3.2, there is a unique (tp)-cyclotomic polynomial Ψ such that ℓ divides $\Psi(q)$ and Ψ divides the polynomial order of G (we have $\Psi = \Phi_h$ if we exclude the Ree and Suzuki groups). Therefore the group $[\mathbf{M}^*, \mathbf{M}^*]^{F^*}$ contains a non-trivial ℓ -subgroup if and only if Ψ appears in its polynomial order, that is if $[\mathbf{M}^*, \mathbf{M}^*]$ contains an F^* -stable component with the same Coxeter number as (\mathbf{G}, F) . The Coxeter numbers for exceptional groups are given in Table 1.

(\mathbf{G}, F)	2B_2	3D_4	2E_6	E_6	E_7	E_8	2F_4	F_4	2G_2	G_2
h	8	12	18	12	18	30	24	12	12	6

Table 1: Coxeter numbers for exceptional groups

Using the extended Dynkin diagram, one can check that the only centralisers of isolated elements that have the same Coxeter number are $A_2 \times A_2 \times A_2$ realised as ${}^2A_2(q^3)$ for ${}^2E_6(q)$ and as $A_2(q) \times {}^2A_2(q^2)$ for E_6 , and A_2 realised as ${}^2A_2(q)$ for G_2 . By [15, §2] and [21, §2], the first two cases never happen for simply connected groups. \square

For classical groups, the ℓ -blocks with cyclic defect have been determined in [22]. For G_2 they are given in [36] (note that when $q \equiv -1$ modulo 3 there exists a non-trivial quasi-isolated block). As a consequence, the Jordan decomposition provides an inductive argument for determining all the ℓ -blocks up to Morita equivalence.

Theorem 3.12. *Assume \mathbf{G} is an adjoint simple group. In the Coxeter case, the Brauer tree of any non-trivial ℓ -block of G is known.*

Remark 3.13. Using [15] and [14], one can check that for groups of type 2B_2 , 3D_4 , 2E_6 , E_8 , 2F_4 and 2G_2 , the order of the derived group of the centraliser of any semisimple element is coprime to ℓ . Therefore any non-principal ℓ -block will be either trivial or Morita equivalent to $\mathcal{O}S_\ell$.

3.4 New planar embedded Brauer trees

We give here the new Brauer trees that we have obtained. Note that the shape of the trees for 2F_4 and F_4 were already known by [27] and [28] but the planar embeddings was known for F_4 and $p \neq 2, 3$ only (cf. [18]). We have used the package CHEVIE of GAP3 to label the irreducible unipotent characters with the convention that 1, ε and r stand respectively for the trivial, the sign and the reflection representation of a Coxeter group.

3.4.1 Type 2F_4 . Here $q = 2^m \sqrt{2}$ for some integer $m \geq 1$. The Coxeter case corresponds to prime numbers ℓ dividing $\Phi'_{24}(q) = q^4 - \sqrt{2}q^3 + q^2 - \sqrt{2}q + 1$. The class of q in k is a primitive 24-th root of unity. We have denoted by θ (resp. i , resp. η) the unique primitive 3-rd (resp. 4-th, resp. 8-th) root of unity which is equal to q^8 (resp. q^6 , resp. q^3) in k . The planar embedded Brauer tree of the principal ℓ -block is given by Fig. 1.

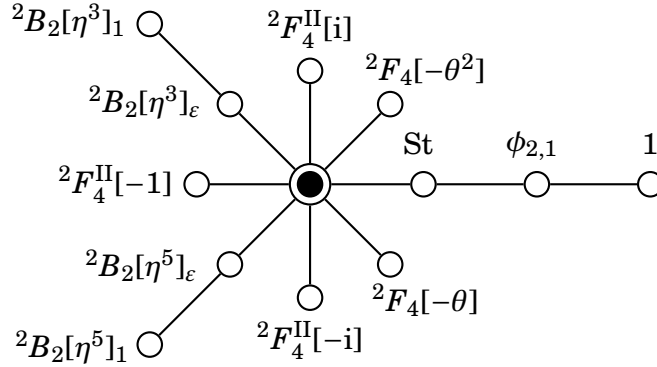
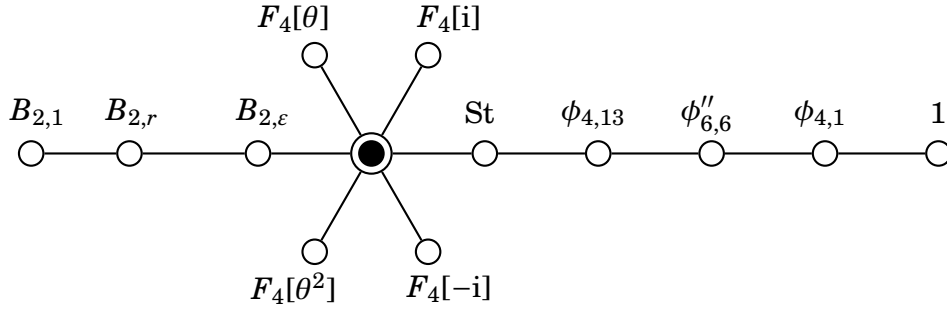

Figure 1: Brauer tree of the principal Φ'_{24} -block of 2F_4

3.4.2 Type F_4 . The Coxeter case corresponds to prime numbers ℓ dividing $\Phi_{12}(q) = q^4 - q^2 + 1$. The class of q in k is a primitive 12-th root of unity. We have denoted by θ (resp. i) the unique primitive 3-rd (resp. 4-th) root of unity which is equal to q^4 (resp. q^3) in k . The planar embedded Brauer tree of the principal ℓ -block is given by Fig. 2.

3.4.3 Type E_7 . The Coxeter case corresponds to prime numbers ℓ dividing $\Phi_{18}(q) = q^6 - q^3 + 1$. The class of q in k is a primitive 18-th root of unity. We

Figure 2: Brauer tree of the principal Φ_{12} -block of F_4

fix a square root $\sqrt{q} \in \mathcal{O}$ of q . We have denoted by θ (resp. i) the unique primitive 3-rd (resp. 4-th) root of unity which is equal to q^6 (resp. $(\sqrt{q})^9$) in k . The planar embedded Brauer tree of the principal ℓ -block is given by Fig. 3.

3.4.4 Type E_8 . The Coxeter case corresponds to prime numbers ℓ dividing $\Phi_{30}(q) = q^8 + q^7 - q^5 - q^4 - q^3 + q + 1$. The class of q in k is a primitive 30-th root of unity. We fix a square root $\sqrt{q} \in \mathcal{O}$ of q . We have denoted by θ (resp. i , resp. ζ) the unique primitive 3-rd (resp. 4-th, resp. 5-th) root of unity which is equal to q^{10} (resp. $(\sqrt{q})^{15}$, resp. q^6) in k . The planar embedded Brauer tree of the principal ℓ -block is given by Fig. 4.

Remark 3.14. (*Communicated by David Craven*) From the Coxeter case in E_7 one can also deduce the Brauer trees of the principal Φ_{18} -block of E_8 and its Alvis-Curtis dual. Assume q has order 18 modulo ℓ . Then there exists an F -stable parabolic subgroup $\mathbf{P} = \mathbf{L}\mathbf{U}$ of \mathbf{G} with F -stable Levi complement \mathbf{L} such that $\ell \nmid [G : L]$ (take \mathbf{L} to be the centraliser of a Φ_{18} -torus). Let c (resp. b) be the principal ℓ -block of L (resp. G). Then $b(\mathcal{O}G/U)c$ is a finitely generated $(b\mathcal{O}G, c\mathcal{O}L)$ -bimodule that is projective as a $b\mathcal{O}G$ -module and as a right $c\mathcal{O}L$ -module. Moreover one can check that the functor $b(KG/U)c \otimes_{KL} -$ induces a bijection between the irreducible characters in c and b . By [4, Théorème 0.2], we deduce that the functor $b\mathcal{O}G/Uc \otimes_{\mathcal{O}L} -$ induces a Morita equivalence between $c\mathcal{O}L$ and $b\mathcal{O}G$. In particular we obtain the planar embedded Brauer tree of the principal Φ_{18} -block of E_8 from the tree of the principal Φ_{18} -block of E_7 . The same argument applies to the ℓ -block of G containing the Steinberg character.

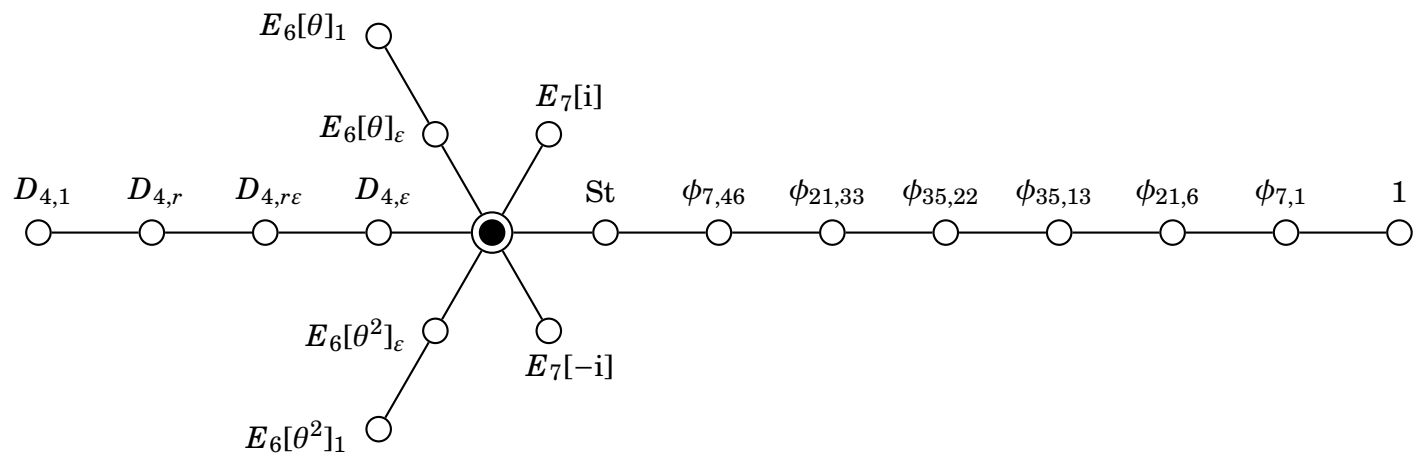

Figure 3: Brauer tree of the principal Φ_{18} -block of E_7

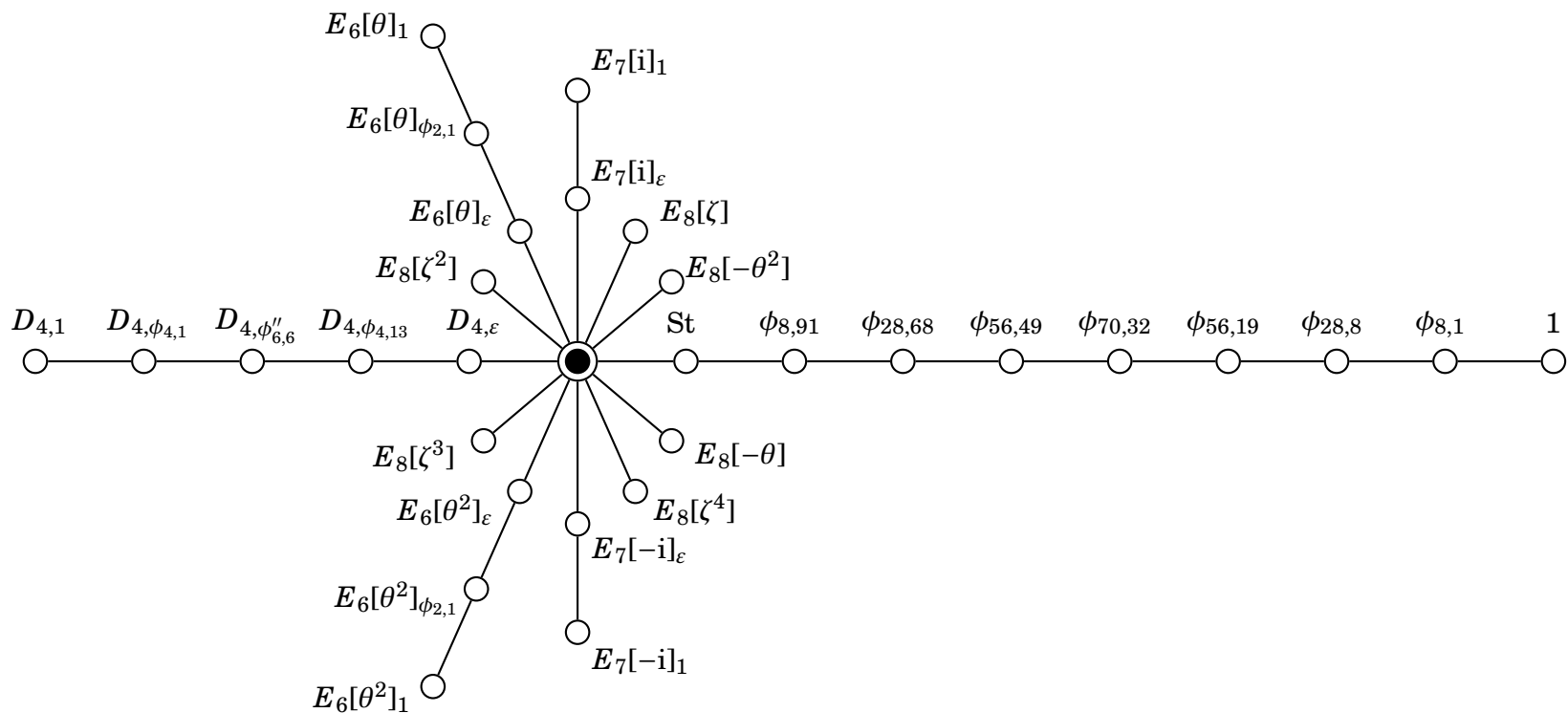

Figure 4: Brauer tree of the principal Φ_{30} -block of E_8

References

- [1] A. Bökstedt, Marcel and Neeman. Homotopy limits in triangulated categories. *Compositio Math.*, 86:209–234, 1993.
- [2] C. Bonnafé. Quasi-isolated elements in reductive groups. *Comm. Algebra*, 33(7):2315–2337, 2005.
- [3] C. Bonnafé and R. Rouquier. Catégories dérivées et variétés de Deligne-Lusztig. *Publ. Math. Inst. Hautes Études Sci.*, (97):1–59, 2003.
- [4] M. Broué. Isométries de caractères et équivalences de Morita ou dérivées. *Inst. Hautes Études Sci. Publ. Math.*, (71):45–63, 1990.
- [5] M. Broué and G. Malle. Zyklotomische Heckealgebren. *Astérisque*, (212): 119–189, 1993. Représentations unipotentes génériques et blocs des groupes réductifs finis.
- [6] M. Broué, G. Malle, and R. Rouquier. Complex reflection groups, braid groups, Hecke algebras. *J. Reine Angew. Math.*, 500:127–190, 1998.
- [7] M. Broué and J. Michel. Sur certains éléments réguliers des groupes de Weyl et les variétés de Deligne-Lusztig associées. In *Finite reductive groups (Luminy, 1994)*, volume 141 of *Progr. Math.*, pages 73–139.
- [8] M. Broué and J. Michel. Blocs et séries de Lusztig dans un groupe réductif fini. *J. Reine Angew. Math.*, 395:56–67, 1989.
- [9] M. Cabanes and M. Enguehard. Local methods for blocks of reductive groups over a finite field. In *Finite reductive groups (Luminy, 1994)*, volume 141 of *Progr. Math.*, pages 141–163. Birkhäuser Boston, Boston, MA, 1997.
- [10] M. Cabanes and M. Enguehard. On blocks of finite reductive groups and twisted induction. *Adv. Math.*, 145(2):189–229, 1999.
- [11] D. Craven. On the cohomology of Deligne-Lusztig varieties, arXiv:1107.1871v1. *Preprint*, 2011.
- [12] D. Craven. Perverse equivalences and Broué’s conjecture II: the cyclic case. *In preparation*, 2012.
- [13] P. Deligne and G. Lusztig. Representations of reductive groups over finite fields. *Ann. of Math. (2)*, 103(1):103–161, 1976.
- [14] D. I. Deriziotis. The centralizers of semisimple elements of the Chevalley groups E_7 and E_8 . *Tokyo J. Math.*, 6(1):191–216, 1983.

-
- [15] D. I. Deriziotis and M. W. Liebeck. Centralizers of semisimple elements in finite twisted groups of Lie type. *J. London Math. Soc. (2)*, 31(1):48–54, 1985.
- [16] F. Digne and J. Michel. *Representations of finite groups of Lie type*, volume 21 of *London Mathematical Society Student Texts*. Cambridge University Press, Cambridge, 1991.
- [17] F. Digne and J. Michel. Parabolic Deligne-Lusztig varieties, arxiv:1110.4863. *preprint*, 2011.
- [18] O. Dudas. Coxeter Orbits and Brauer trees II, arXiv:math/1011.5478. *preprint*, 2010.
- [19] O. Dudas. Coxeter Orbits and Brauer trees. *Adv. Math.*, 229(6):3398–3435, 2012.
- [20] W. Feit. *The representation theory of finite groups*, volume 25 of *North-Holland Mathematical Library*. North-Holland Publishing Co., Amsterdam, 1982.
- [21] P. Fleischmann and I. Janiszczak. The semisimple conjugacy classes of finite groups of Lie type E_6 and E_7 . *Comm. Algebra*, 21(1):93–161, 1993.
- [22] P. Fong and B. Srinivasan. Brauer trees in classical groups. *J. Algebra*, 131(1):179–225, 1990.
- [23] M. Geck. Brauer trees of Hecke algebras. *Comm. Algebra*, 20(10):2937–2973, 1992.
- [24] D. Gorenstein, R. Lyons, and R. Solomon. *The classification of the finite simple groups. Number 3. Part I. Chapter A*, volume 40 of *Mathematical Surveys and Monographs*. American Mathematical Society, Providence, RI, 1998. Almost simple K -groups.
- [25] J. A. Green. Walking around the Brauer Tree. *J. Austral. Math. Soc.*, 17:197–213, 1974. Collection of articles dedicated to the memory of Hanna Neumann, VI.
- [26] F. Grunewald, A. Jaikin-Zapirain, and P. A. Zalesskii. Cohomological goodness and the profinite completion of Bianchi groups. *Duke Math. J.*, 144(1):53–72, 2008.
- [27] G. Hiss. The Brauer trees of the Ree groups. *Comm. Algebra*, 19(3), 1991.
- [28] G. Hiss and F. Lübeck. The Brauer trees of the exceptional Chevalley groups of types F_4 and 2E_6 . *Arch. Math. (Basel)*, 70(1):16–21, 1998.

- [29] G. Hiss, F. Lübeck, and G. Malle. The Brauer trees of the exceptional Chevalley groups of type E_6 . *Manuscripta Math.*, 87(1):131–144, 1995.
- [30] B. Keller. On the construction of triangle equivalences. In *Derived equivalences for group rings*, volume 1685 of *Lecture Notes in Math.*, pages 155–176. Springer, Berlin, 1998.
- [31] G. Lusztig. Coxeter orbits and eigenspaces of Frobenius. *Invent. Math.*, 38(2):101–159, 1976/77.
- [32] T. Nakamura. A note on the $K(\pi, 1)$ property of the orbit space of the unitary reflection group $G(m, l, n)$. *Sci. Papers College Arts Sci. Univ. Tokyo*, 33(1):1–6, 1998.
- [33] J. Rickard. Finite group actions and étale cohomology. *Inst. Hautes Études Sci. Publ. Math.*, (80):81–94 (1995), 1994.
- [34] R. Rouquier. Complexes de chaînes étales et courbes de Deligne-Lusztig. *J. Algebra*, 257(2):482–508, 2002.
- [35] J.-P. Serre. *Galois cohomology*. Springer Monographs in Mathematics. Springer-Verlag, Berlin, english edition, 2002. Translated from the French by Patrick Ion and revised by the author.
- [36] J. Shamash. Brauer trees for blocks of cyclic defect in the groups $G_2(q)$ for primes dividing $q^2 \pm q + 1$. *J. Algebra*, 123(2):378–396, 1989.
- [37] T. A. Springer. Regular elements of finite reflection groups. *Invent. Math.*, 25:159–198, 1974.

OLIVIER DUDAS: MATHEMATICAL INSTITUTE, UNIVERSITY OF OXFORD, 24-29 ST GILES', OXFORD, OX1 3LB, UK.

E-mail address: `dudas@maths.ox.ac.uk`

RAPHAËL ROUQUIER: MATHEMATICAL INSTITUTE, UNIVERSITY OF OXFORD, 24-29 ST GILES', OXFORD, OX1 3LB, UK AND DEPARTMENT OF MATHEMATICS, UCLA, BOX 951555, LOS ANGELES, CA 90095-1555, USA.

E-mail address: `rouquier@maths.ox.ac.uk`