



HAL
open science

A Boundary Operator for Computing the Homology of Cellular Structures

Sylvie Alayrangues, Guillaume Damiand, Pascal Lienhardt, Samuel Peltier

► **To cite this version:**

Sylvie Alayrangues, Guillaume Damiand, Pascal Lienhardt, Samuel Peltier. A Boundary Operator for Computing the Homology of Cellular Structures. 2011. hal-00683031v1

HAL Id: hal-00683031

<https://hal.science/hal-00683031v1>

Submitted on 27 Mar 2012 (v1), last revised 2 Oct 2013 (v2)

HAL is a multi-disciplinary open access archive for the deposit and dissemination of scientific research documents, whether they are published or not. The documents may come from teaching and research institutions in France or abroad, or from public or private research centers.

L'archive ouverte pluridisciplinaire **HAL**, est destinée au dépôt et à la diffusion de documents scientifiques de niveau recherche, publiés ou non, émanant des établissements d'enseignement et de recherche français ou étrangers, des laboratoires publics ou privés.

A Boundary Operator for Computing the Homology of Cellular Structures

S. Alayrangues G. Damiand P. Lienhardt S. Peltier

Abstract

The paper focuses on homology computation over cellular structures through the computation of incidence numbers. Roughly speaking, if two cells are incident, then their incidence number characterizes how they are attached. Having these numbers naturally leads to the definition of a boundary operator, which induces a cellular homology. More precisely, the two main families of cellular structures (incidence graphs and ordered models) are studied through various models. A boundary operator is then proposed for the most general structure, and is optimized for the other structures. It is proved that, under specific conditions, the cellular boundary operator proposed in this paper defines a cellular homology equivalent to the simplicial one.

Keywords: cellular homology computation, incidence graph-based representations, ordered models, boundary operator.

1 Introduction

Many simplicial and cellular structures have been defined in geometric modeling [AdFF85, Bau75, BD94, CMP06, CCM97, CR91, DFMMMP03, DFMP03b, DFMP03a, HC93, Lie89, Lie91, LL96, LL01, LL90, M88, MH90, PBCF93, PFL09, PFP95, Wei85, Wei86], image analysis [Bau75, BDF00, BDDV03, BG88, BK03, DBF04, DCB03, DD08, BG88, GP90, MK05, PIK⁺09] and computational geometry [Bri89, DL89, Ede87, GS85, Spe91]. We focus here on cellular

⁰S. Alayrangues, P. Lienhardt, S. Peltier
Université de Poitiers, Laboratoire XLIM, Département SIC, CNRS 6172;
Bâtiment SP2MI - Téléport 2; Boulevard Marie & Pierre Curie; BP 30179; 86962 Futuroscope-
Chasseneuil Cedex; France
sylvie.alayrangues@xlim.fr
pascal.lienhardt@xlim.fr
samuel.peltier@xlim.fr

G. Damiand
LIRIS UMR 5205; Université Claude Bernard; Bâtiment Nautibus (710); 43 Boulevard du 11
Novembre 1918; 69622 Villeurbanne Cedex; France
guillaume.damiand@liris.cnrs.fr

structures used to encode finite nD -space subdivisions. Schematically, such structures are defined according to two main approaches. In both, the topology of cellular objects is unambiguously defined as the topology of their *simplicial analog*, i.e. it is possible to associate a simplicial object with any cellular object, and this simplicial object is structured into cells (cf. Section 2).

Incidence graph based representations rely on an explicit definition of the cells and their incidence relations whereas their associated abstract simplicial complex is implicitly defined [Ber99, Ede87, RO89, Sob89]. *Ordered models*, as cell-tuple and combinatorial map derived structures, explicitly provide the simplicial interpretation of an object and implicitly encode the cells and their incidence relations [Bri93, Lie94, Vin83]. Both approaches have specific advantages and drawbacks. Incidence graphs intrinsically provide a direct access to the cells and to their incidence relations. But they suffer from three major limitations. First they are definitely not able to encode subdivisions with any kind of multi-incidence (for instance a loop edge, in which the vertex is incident twice to the edge). Then they do not make any assumption on the topology of the cells. For instance, in such a representation, nothing prevents an edge to be incident to more than two vertices. To tackle this difficulty, subclasses of such structures have been exhibited (e.g. n -surfaces [Ber99, EKM96]). But the properties they have to fulfill are expensive to check. Finally such cellular representations have only been equipped with a few operations, because they are not able to easily provide control over the evolution of their topology. Ordered models overcome most drawbacks of incidence graphs: they are able to encode subdivisions with multi-incidence, topological properties of cells are contained in their very definition, and topological modifications induced by local operations are naturally monitored. As an expectable counterpart, the memory cost of such representations is usually higher. Moreover though the topology of cells is more constrained, there still may exist peculiar cells (e.g. cells which are not homeomorphic to balls ¹).

Many data structures based either on incidence graph or on ordered model approaches have been designed, each with its own advantages and drawbacks. They usually incorporate constraints either on the topology of the cells (e.g. homeomorphic to balls, to cones) or on the way cells are glued together (e.g. pseudo-manifolds, quasi-manifolds). Structures derived from incidence graphs are usually completed with consistency properties and are more expensive to handle than simple incidence graphs (e.g. n -surfaces). On the contrary, subclasses of ordered models as combinatorial maps generally provide optimizations by taking advantage of the topological properties of the represented cellular object. The choice of one structure rather than another essentially depends on the requirements of the application. A compromise has often to be made between three kinds of complexity: space complexity to store the structure, time complexity for handling them, and difficulty of algorithms design and imple-

¹Note that speaking of cellular structures, we do not make any assumption either on the topology of cells nor on the way they are glued together. More precisely, “cellular structures” does not mean “CW-complexes” and n -dimensional cells do not have to be homeomorphic to n -balls. The definition of cells for cellular structures will be precised in Section 2.

mentation.

Many applications require the computation of topological properties of cellular objects. We focus here on homology groups which contain meaningful topological information and are computable similarly in any dimension [Ago76, Hat02]. Intuitively these groups describe different kinds of “holes” of an object (e.g. connected components, tunnels, cavities). Generators of these groups provide a representation of the homological information directly onto the structure. Initially homology was only defined on abstract simplicial complexes but it has been extended to other topological objects, such as semi-simplicial sets [May67] and *CW*-complexes [FP90]. Algorithms have been designed to compute homological information, and their complexities are naturally highly related to the number of cells of the studied object.

The topology of the cellular structures we previously mention is by definition the topology of their simplicial analog. Their homology groups can hence be computed on the associated simplicial structure but this representation generally contains many more cells, in fact simplices, than the original cellular structure. Therefore, we choose to study *how to compute them directly on the cellular structure*.

To achieve this goal, a *chain complex* has to be constructed from the cellular structure. It is composed of two types of elements: groups and homomorphisms between them. *Chain groups* are naturally constructed as linear combinations of cells of the object, with coefficients in a given abelian group (e.g. \mathbb{Z} , $\mathbb{Z}/n\mathbb{Z}$). The choice of a suitable coefficient group is guided by the properties of the cellular object. The whole homology information is obtained when using \mathbb{Z} and requires each cell of the object to be orientable. When the object itself is orientable, computing homology over $\mathbb{Z}/2\mathbb{Z}$ is enough. Defining *boundary homomorphisms* between chain groups is much more difficult and proving that they induce a homology equivalent to the simplicial one is an even trickier challenge. The design of suitable boundary homomorphisms relies on the characterization of the incidence between any pair of cells having consecutive dimensions. Such relations are expressed through *incidence numbers* which tell how many times a cell is attached to another. For instance, a cylinder constructed by folding a piece of paper and gluing opposite sides together contains an edge twice incident to its face.

In this paper, we study the definition and the computation of incidence numbers for several cellular structures: for incidence graphs, *orders* in which the cells are n -surfaces [Ber99, DCB05]; for ordered models, *chains of maps, generalized maps and maps* [EL94, Lie94]. We choose these structures since they are representative of structures which are usually handled in different fields of geometric modeling, computational geometry and discrete geometry, for representing “non manifold” or “manifold” objects. From the definition of incidence numbers, different algorithms can be deduced for computing them, and we propose some algorithms which can be adapted for different structures.

More precisely the contributions of this paper are of two kinds. The first one is related to combinatorial structures. We exhibit indeed a formal link between a subclass of incidence graphs and a subclass of chains of maps (Section 6). Other

contributions deal with the computation of homology on cellular structures. We begin with defining boundary operators over $\mathbb{Z}/2\mathbb{Z}$ and \mathbb{Z} on suitable subclasses of incidence graphs (Section 3) and chains of maps (Section 4). This extends the results of [Bas10] and [APDL09] onto wider classes of, respectively, incidence graphs and combinatorial maps. We give then a purely combinatorial proof of the equivalence between the cellular homology induced by these boundary operators and the simplicial one that can be computed on the simplicial interpretation of both structures (Sections 5 and 6). The provided proof follows a different path than the one developed for a more restricted subclass of incidence graphs in [Bas10]. We also supply algorithms on both structures to compute the matrices encoding the boundary operators. Finally we study the optimization of these boundary operators on subclasses of chains of maps: generalized maps (Section 7) and maps (Section 8) and give adapted computation algorithms.

The paper is organized as follows. Section 2 covers the whole background of the paper. It briefly recalls essential notions about homology theory and associated computation methods (Section 2.1 page 5). Then it presents both families of cellular structures we are interested in (Section 2.2 page 7 and Section 2.3 page 13). It concludes by an explanation of the motivations and the ins and outs of this work (Section 2.4 page 17). Sections 3 and 4 respectively focus on the definition and computation of boundary operators for incidence graphs and chains of maps. They follow the same outline. The definition of the studied structure is given (Sections 3.1 and 4.1 pages 19 and 25). Then a notion of unsigned incidence number is provided which is proved to lead to a consistent boundary operator over $\mathbb{Z}/2\mathbb{Z}$ (Sections 3.2 and 4.2 pages 20 and 29). Afterwards this notion is extended to obtain a signed incidence number which in turn is proved to produce a sound boundary operator (Sections 3.3 and 4.3 pages 21 and 32). Finally an algorithm computing the matrix representation of this boundary operator is given for each structure (Sections 3.4 and 4.4 pages 23 and 35). The proof of the equivalence between the cellular homology defined on chain of maps and the classical simplicial one is detailed in Section 5 by building a correspondence between cellular and simplicial chains and showing that it preserves both cycles and boundaries. The proof of a similar equivalence for the subclass of incidence graphs is given in Section 6. It is based on the correspondence between this subclass and a subclass of chains of maps (proved in Section 6.1). Sections 7 and 8 pages 54 and 60 present optimizations by focusing on more specialized structures, respectively generalized maps and maps. We present in Section 9 some preliminary results, and finally we conclude and give some insight into future works (Section 10 page 62).

2 Background on cellular structures and homology

2.1 Homology

Characterizing subdivided objects regarding their topological structure is of interest in different domains of computer graphics, discrete geometry or geometric modeling (e.g. [LPR93, NSK⁺02, VL07]). More precisely, two topological spaces are “equal” if there exists a *homeomorphism* between them. In general, it is very difficult to prove that there exists or not an homeomorphism between two topological spaces. So topological invariants have been introduced. A topological invariant is a property that is preserved by homeomorphisms. Otherwise said, if a property is true on a topological space A , then it will also be true on B if A is homeomorphic to B . There exists many topological invariants as the number of connected components, the Euler characteristic, the fundamental group, the homology groups or the orientability.

Among all the existing topological invariants, we are especially interested in homology groups because they are classically studied in algebraic topology ([Mun30]), and known to be powerful. For each dimension $i = 0..n$, the homology group H_i of an nD object characterizes its holes (connected components for H_0 , tunnels for H_1 , cavities for $H_2...$). Informally, homology groups can be defined as the characterization of how the cells are glued together, and this is done by studying the boundary of each cell. Moreover, from a computational point of view, homology groups are defined in the same way in any dimension and are directly linked to the cells of an object and their incidence relations.

2.1.1 Chain complex

In this part, the algebraic notions of chain, cycle, boundary, and homology generator, are illustrated using Fig. 1.

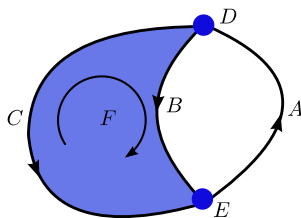

Figure 1: A cellular subdivision having the following homology groups: $H_0 \simeq H_1 \simeq \mathbb{Z}$, $H_i \simeq 0$ for $i > 1$. $3A - 6B$ and $C + 2B$ are 1-chains. As examples, $A + B$ is a 1-cycle as $(A + B)\partial = D - E + E - D = 0$ and $B - C$ is a 1-boundary as $B - C = F\partial$. The 1-chains $A + B$ and $A + C$ are homologous as $A + C + F\partial = A + B$. D is a generator for H_0 and $A + C$ is a generator of H_1 .

Homology groups are defined from an algebraic structure called a chain complex, i.e. a sequence $C_n \xrightarrow{\partial_n} C_{n-1} \xrightarrow{\partial_{n-1}} \dots \xrightarrow{\partial_1} C_0 \xrightarrow{\partial_0} 0$ of (boundary) homomorphisms of abelian groups satisfying $\partial\partial = 0$ ². A chain complex can be associated with a subdivided object A in the following way: each chain group C_i of dimension i , is generated by all the i -cells of A . The boundary homomorphisms are defined over chains of cells as linear extensions of the basic boundary operators defined for each cell. For example, the boundary of the chain $2c_1 - 3c_2$ (denoted $(2c_1 - 3c_2)\partial$) is defined as $2c_1\partial - 3c_2\partial$. Thus, computing homology groups over a combinatorial structure (abstract simplicial complex, orders, generalized maps...) requires a basic boundary operator over cells.

2.1.2 Cycles, boundaries, homology groups

Among all the possible chains, homology consider two particular kinds of chains: cycles and boundaries. A cycle z is a chain satisfying $z\partial = 0$, a chain b is a boundary if there exists a chain c satisfying $c\partial = b$. For each dimension i , the set of i -cycles equipped with the addition is a subgroup of C_i , denoted Z_i . The set of all i -boundaries equipped with the addition is a subgroup of Z_i , denoted B_i (a boundary is a cycle as the property $c\partial\partial = 0$ has to be satisfied for any chain).

Homology groups H_i are defined as the quotient group Z_i/B_i . So the elements of the homology group H_i are equivalence classes such that two cycles are in the same equivalence class if they differ by a boundary.

Homology groups are finitely generated abelian groups, so the following theorem describes their structure [Hat02].

Every finitely generated abelian group G is isomorphic to a direct sum of the form:

$$\underbrace{\mathbb{Z} \oplus \dots \oplus \mathbb{Z}}_{\beta} \oplus \mathbb{Z}/t_1\mathbb{Z} \oplus \dots \oplus \mathbb{Z}/t_k\mathbb{Z}.$$

where $1 < t_i \in \mathbb{Z}$ and t_i divides t_{i+1} .

The rank β of an homology group is also called its Betti number, and the t_i are also known as its torsion coefficients.

2.1.3 Homology generators

Depending on what is expected, “computing homology” may have different meanings. For example, the number of i -dimensional holes of a given object is completely defined by the Betti numbers and the torsion coefficients. But if one is interested in computing homology generators, these numbers are not sufficient, the computation of one representant cycle per homology class is needed.

²Usually, we do not explicitly denote the dimensions of the boundary homomorphisms.

2.1.4 Different coefficients

In the previous description of homology groups, it was implicit that all the chains are considered with coefficients over \mathbb{Z} . In a more general point of view, homology groups can be computed with any coefficients (e.g. homology on $\mathbb{Z}/2\mathbb{Z}$ or \mathbb{Q}).

The universal coefficient theorem [Hat02] ensures that all the homological information is contained in homology groups with coefficients in \mathbb{Z} . But for optimisation purposes, it may be useful to compute with other coefficients. In particular, homology over $\mathbb{Z}/2\mathbb{Z}$ is interesting for torsion-free objects, as in this case, these groups are known to be isomorphic to the homology groups over integer coefficients.

2.1.5 Computing homology

Several algorithms have been designed to compute Betti numbers, torsion coefficients and eventually homology groups generators. The most classical approach is based on incidence matrices reductions into the so-called Smith Normal Form [Ago76, Mun30, KB79, PAFL06a]. Generally the incidence matrices of the whole object are handled, involving sometimes a high computational cost and memory issues since huge integers may occur during the computational process [KB79]. Many works aim at optimizing this process [DSV01, Gie96, Sto96]. Others aim at simplifying the structure while preserving its topology [GDJMR09, KMS98, KMM04]. Some works follow an incremental approach and intend to compute the homology of an object while constructing it [DPF08, DE95]. More recently, persistence homology theory has been introduced [ELZ02]. Informally, this original approach allows to describe the topology of an object at different scales. In particular, persistent homology led to the notion of localized homology for computing "nice" generators [ZC08].

2.2 Cellular structures

2.2.1 Incidence graph based structures

aim at characterizing a subdivision through the incidence relations between its cells. Roughly speaking the vertices of such a graph represent the cells of the subdivision and an edge exists between two vertices when the corresponding cells are incident. Note that such structures are not able to accurately represent subdivisions containing multiply incident cells. But they are still generic because their natural definitions include no other constraint on the subdivision than mono-incidence and does not make any assumption on the topology of cells.

Many structures based on this approach have been designed and adapted to different kinds of applications, e.g. [Sob89, RO89, Ede87]. Their differences lie either on the way they are defined (e.g. with an explicit or implicit dimension associated with each vertex of the graph) or on the kinds of subdivisions they encode (e.g. n -surfaces). In the latter case, additional constraints are added in

order to ensure some topological properties of the represented subdivisions (e.g. to grant some similarities with manifolds).

We choose here an order-based representation of incidence graphs where the dimension of cells is implicitly defined [Ber99]. It is a bit more restrictive than some other definitions because there cannot be any “dimensional gap” between two incident cells. More precisely whenever two cells of dimensions i and j are incident, there exists at least one cell of each dimension between i and j which is incident to both cells.

We first recall the definition of a locally finite order.

Definition 2.1 (CF-order [Ber99]) *An order is a pair $|X| = (X, \alpha)$, where X is a set and α a reflexive, antisymmetric, and transitive binary relation. We denote β the inverse of α and θ the union of α and β . CF-orders are orders which are countable, i.e. X is countable, and locally finite, i.e. $\forall x \in X, \theta(x)$ is finite.*

We introduce some vocabulary and notations (based on [DCB03, DCB05]) and carefully relate them to those classically defined on cellular subdivisions. The set $\alpha(x)$ is called the α -adherence of x and represents the closure of cell x , i.e. x and all cells of lower dimensions incident to x (i.e. the cells in the boundary of x). The set $\beta(x)$ is similarly called β -adherence of x and encodes the star of x , i.e. x and all cells of greater dimensions to which x is incident. The θ -adherence of x is simply the union of the closure and of the star of x . The strict α -, β - and θ -adherences are respectively denoted by α^\square , β^\square , and θ^\square and contain all elements of the corresponding adherence except x itself. The notion of α -closeness of x , denoted by $\alpha^\bullet(x)$, also proves useful. This set contains the elements of the order which are the closest to x according to α . It is formally defined as the set: $\{y \in \alpha^\square(x), \alpha^\square(x) \cap \beta^\square(y) = \emptyset\}$. The β - and θ -closeness are similarly defined.

There are many ways to visually represent orders. We choose here to use simple Directed Acyclic Graphs (DAG), whose vertices are exactly the elements of X and each oriented edge relates an element x to an element of $\alpha^\bullet(x)$. We use hence the DAG (X, α^\bullet) to represent the order (X, α) . The set $\alpha(x)$ is naturally obtained from the DAG by extracting the transitive closure of $\alpha^\bullet(x)$ (see Fig. 2(c) page 10).

If S is any subset of X , $(S, \alpha \cap S \times S)$ is a suborder of $|X|$ and is denoted by $|S| = (S, \alpha|_S)$.

Finally a sequence x_0, x_1, \dots, x_n such that x_i belongs to $\theta^\square(x_{i+1})$ is called a θ -chain of length n , n - θ -chain or simply a path. An order is said to be connected if it is path-connected. Note that α -, α^\bullet -, β -, β^\bullet -chains are similarly defined. The rank of an element denoted by $\rho(x, |X|)$ is defined as the length of the longest α^\bullet -chain beginning at it. The rank of an order is simply the highest rank of its elements.

The rank of an element can be seen as its implicit dimension. To grant that this implicit dimension is consistent with the dimension in the underlying subdivision, we only deal with subdivisions which can be encoded by closed CF-orders. The closeness condition prevents any “dimensional gap” from occurring

in the subdivision and in its representative order. It yields hence to the equality of the notions of dimension in both representations.

Definition 2.2 (closed order [Ber99]) *Let $|X|$ be an order of rank n , $|X|$ is said to be closed if for any $x \in X$ and $y \in \alpha^\square(x)$:*

$$\forall i \in]\rho(y, |X|), \rho(x, |X|], \exists z \in \alpha^\square(x) \cap \beta^\square(y), \rho(z, |X|) = i$$

The *main* cells are the cells the strict stars of which are empty. A *pure* order is such that all main cells have the same dimension ³.

Usually any order is associated with a simplicial interpretation built on the α -chains of the order. The *order complex* of an order $|X|$, denoted by $\Delta(|X|)$ is an abstract simplicial complex and defines the topology of the order.

Definition 2.3 (abstract simplicial complex [Ago76]) *An abstract simplicial complex (V, Δ) is a set of vertices V together with a family Δ of finite non-empty subsets of V , called simplices, such that $\emptyset \neq \sigma \subseteq \tau \in \Delta$ implies $\sigma \in \Delta$.*

The dimension of a simplex σ in Δ , $\dim_\Delta(\sigma)$ is its cardinality less 1.

Vertices of the order complex are exactly the elements of the order. And there is a bijection between the sets of k -simplices and the sets of k - α -chains. Obviously the incidence relations between simplices are deduced from the inclusion relations between α -chains. Moreover the order complex associated with a closed order is a *numbered* abstract simplicial complex, i.e. there exists a numbering of the vertices such that the vertices of each main i -simplex are numbered from 0 to i (see Figs. 2(c) and 2(b) page 10, where v_1 and v_2 , e_1 and e_2 , f_1 and f_2 respectively correspond to both vertices numbered 0, 1 and 2.). Labeling each element of a closed order with its implicit dimension provides such a numbering. Note that when the closed order is also pure, all main simplices are numbered from 0 to n .

The orders described so far are so little constrained that they would be able to encode “pathologic subdivisions” where, for instance, three vertices could be incident to a same edge. As such configurations should never appear, this allowance is a serious drawback. More specialized orders have been defined to avoid inconsistent configurations.

We focus here on two families of orders. The most constrained is made of n -surfaces, which have manifold-like properties and constitute a subset of pseudomanifolds ⁴. The properties of the associated subdivisions, called *cellular quasimanifolds*, are described further. The other class of order is a generalization of

³These notions and many others as star, boundary, etc are also defined in a similar way for other combinatorial models.

⁴A *closed pseudomanifold* is defined as follow:

- It is a pure, finite n -dimensional abstract simplicial complex ($n \geq 1$) (purity condition);
- Each $(n - 1)$ -simplex is a face of exactly two n -simplices (nonbranching condition);
- Every two n -simplices can be connected by means of a series of alternating n and $(n - 1)$ -simplices, each of which is incident with its successor (strong connectivity condition).

n -surfaces: i -cells have to be i -surfaces but the whole subdivision does not have to. Otherwise said the topology of each cell is restricted but their attachment can be achieved more loosely. This class is formally defined in Section 3.

Definition 2.4 (n -surface) Let $|X| = (X, \alpha)$ be a non-empty CF-order.

- The order $|X|$ is a 0-surface if X is composed exactly of two elements x and y such that $y \notin \alpha(x)$ and $x \notin \alpha(y)$;
- The order $|X|$ is an n -surface, $n > 0$, if $|X|$ is connected and if, for each $x \in X$, the order $|\theta^\square(x)|$ is an $(n - 1)$ -surface.

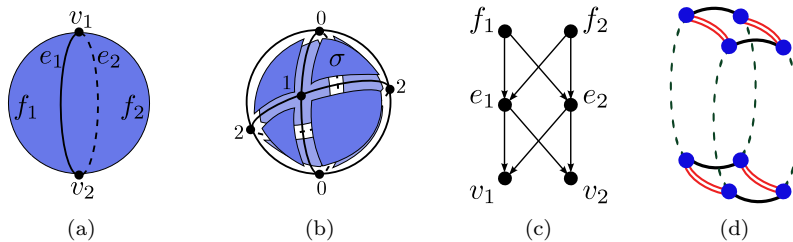

Figure 2: (a) A cellular decomposition of the 2-sphere with 2 faces, 2 edges and 2 vertices. (b) Its associated numbered abstract simplicial complex. (c) The order corresponding to (a) which is a 2-surface. (d) The 2-dimensional generalized map associated with (a).

The definition of orders derived from n -surfaces provides a characterization of a subclass of incidence graphs having manifold-like properties. But such subdivisions are not easy to handle. First, checking if an incidence graph fulfills n -surface properties is expensive. Then modification operators should be carefully designed in order to preserve n -surface properties.

To overcome such difficulties, structures have been designed whose definition mechanisms convey natural restrictions on the kind of subdivisions they are able to encode.

2.2.2 Combinatorial maps based structures

are by construction dedicated to the representation of cellular structures whose cells have regularity properties close to manifold. They are used in many applications related to geometrical modeling as well as image analysis [BSP⁺05, BG88, BDDV03, DBF04, BDF00]. They are also known to be equivalent to other combinatorial structures, such as cell-tuples, facet-edge, quad-edge [Bri93, DL89, GS85, Lie91]. Several families of combinatorial maps have been defined depending on the constraints imposed upon the arrangement of such cells. These structures are not constructed directly from the cells of the subdivision but from a more elementary object, namely a dart. The set

of darts is structured through involutions that describe how they are linked to each other. Such a representation provides an implicit description of cells as sets of darts and conveys hence a more precise description of how the cells of the subdivision are attached together.

We are more particularly interested in three families of combinatorial maps based structures, because they are representative of optimization mechanisms which are at the basis of the definition of commonly used data structures. *Chains of maps* (described in Section 4) are the most general because they impose only few constraints on the way cells are glued together. Then *n-dimensional generalized maps or n-gmaps* (defined below) are a bit more restrictive. Not only the cells have to look like manifolds but the whole subdivision also has to. Finally, *n-dimensional maps* (defined in Section 8) are the most specialized and provide an optimized representation of orientable manifold-like subdivisions without boundaries.

We first recall the notion of *n-gmap*. Subdivisions encoded by such structures are precisely what we have called so far “*manifold-like*” subdivisions and are formally known as “*cellular quasi-manifolds*” (see page 15 and [Lie94])

Definition 2.5 (*n-gmap*) Let $n \geq 0$, an *n-gmap* is defined by an $(n+2)$ -tuple $G = (D, \alpha_0, \dots, \alpha_n)$ such that:

- D is a finite set of darts;
- $\forall i, 0 \leq i \leq n, \alpha_i : D \rightarrow D$ is an involution⁵;
- $\forall i, 0 \leq i \leq n-2, \forall j, i+2 \leq j \leq n, \alpha_i \alpha_j$ is an involution.

We will see that it is possible to associate a simplicial object, more formally a semi-simplicial set, with any *n-gmap*, and this simplicial object is structured into cells. Two examples are displayed respectively on Figs. 2 and 3. The first condition satisfied by the α operators grants that the simplicial object is a quasi-manifold, and the second condition grants that all cells are quasi-manifolds (see page 15). Contrary to incidence graphs, this cellular object is able to contain multiply incident cells (see Fig. 3).

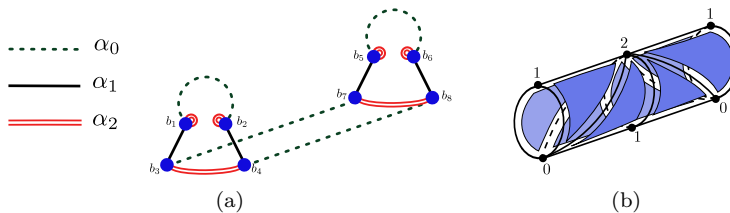

Figure 3: (a) A 2-gmap representing a cylinder. (b) Its associated numbered semi-simplicial set.

⁵i.e. $\alpha_i = \alpha_i^{-1}$.

Darts of an n -gmap can be structured into subsets, which are defined through the notion of orbit (see Fig. 4).

Definition 2.6 (orbit) Let $\Phi = \{\pi_0, \dots, \pi_n\}$ a set of permutations defined on a set D . We denote $\langle \Phi \rangle = \langle \pi_0, \dots, \pi_n \rangle = \langle \rangle_{[0,n]}$ the permutation group of D generated by Φ . The orbit of an element $d \in D$ relatively to $\langle \Phi \rangle$, denoted $\langle \Phi \rangle(d)$ is the set $\{d\phi \mid \phi \in \langle \Phi \rangle\}$. It denotes also the structure $(D^d = \langle \Phi \rangle(d), \pi_0/D^d, \dots, \pi_n/D^d)$, where π_i/D^d denotes the restriction of π_i to D^d .

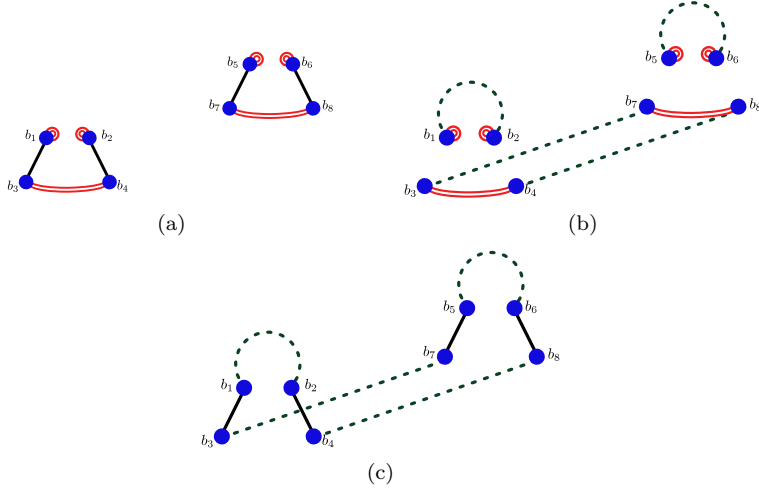

Figure 4: (a) Orbits $\langle \alpha_1, \alpha_2 \rangle$ defining the "neighborhood" of the vertices of the subdivision. (b) Orbits $\langle \alpha_0, \alpha_2 \rangle$ defining the "neighborhood" of the edges. (c) Orbits $\langle \alpha_0, \alpha_1 \rangle$ defining the faces.

The *connected component* of gmap G incident to dart d is the orbit $\langle \alpha_0, \dots, \alpha_n \rangle(d)$. The i -dimensional cell incident to dart d is the orbit $\langle \alpha_0, \dots, \hat{\alpha}_i, \dots, \alpha_n \rangle(d)$, where $\hat{\alpha}_i$ denotes that involution α_i is removed⁷.

Whereas the cellular interpretation of an n -gmap is implicit, a *semi-simplicial set* is more explicitly associated with an n -gmap. Such structures are defined as a set of simplices equipped with operators expliciting the face relations between simplices having consecutive dimensions [May67].

Definition 2.7 (semi-simplicial set) An n -dimensional semi-simplicial set $S = (K, (d_j)_{j=0, \dots, n})$ is defined by:

- $K = \bigcup_{i=0, \dots, n} K_i$, where K_i is a finite set the elements of which are called i -simplices;

⁶We often omit to explicitly indicate the restriction, since it is usually obvious.

⁷In other words, an i -cell is a connected component of the $(n - 1)$ -gmap $(D, \alpha_0, \dots, \hat{\alpha}_i, \dots, \alpha_n)$.

- $\forall j \in \{0, \dots, n\}$, $d_j : K \longrightarrow K$, called face operator, is s.t.:
 - $\forall i \in \{1, \dots, n\}, \forall j \in \{0, \dots, i\}$, $d_j : K_i \longrightarrow K_{i-1}$; $\forall j > i$, d_j is undefined on K_i , and no face operator is defined on K_0 ;
 - $\forall i \in \{2, \dots, n\}, \forall j, k \in \{0, \dots, i\}$, $d_j d_k = d_k d_{j-1}$ for $k < j$.

Each dart of an n -gmap corresponds to an n -simplex of the associated simplicial set. Each orbit $\langle \rangle_{[0,n]-\{k_0, \dots, k_i\}}$ defines an i -simplex numbered (k_0, \dots, k_i) , and the face operators are deduced from the α_i 's. For instance, each orbit $\langle \rangle_{[0,n]-\{i\}}$ corresponds to a 0-simplex numbered i , which identifies an i -cell, and the darts of this orbit describe in fact the neighborhood of the i -cell (see Fig. 4).

2.3 Structural framework

We have seen in the previous sections two families of cellular structures: incidence graphs and combinatorial maps. These structures have in common the fact that they have a simplicial topological interpretation. More precisely incidence graphs are interpreted as numbered abstract simplicial complexes and combinatorial maps are interpreted as numbered semi-simplicial sets. The main difference between these structures is related to multi-incidence. In this section, we will precise all these notions.

2.3.1 Simplicial structures

Abstract simplicial complexes is a well known simplicial structure, which geometric realization is a simplicial complex [Ago76]: such objects are widely used in geometric modeling, computational geometry, etc. The word “abstract” indicates that the structure is based on set theory. More precisely, in this structure, a k -simplex is defined as a set of $k + 1$ vertices, and an abstract simplicial complex is a set of simplices. This implies the fact that there is no multi-incidence between simplices, i.e. both following properties hold (cf. Fig. 5(a)):

- a k -simplex is incident to $k + 1$ distinct vertices;
- distinct simplices have distinct boundaries.

For instance, the *abstract simplicial complex* fully defined by its main simplices: $\{\{B\}, \{A, F\}, \{C, D, E\}, \{E, F, G\}\}$ is geometrically represented on Fig. 5(a).

Semi-simplicial sets are more “flexible” than abstract simplicial complexes in the sense that they allow multi-incidence (see Fig. 5(d)): a k -simplex can be incident to less than $k + 1$ vertices (cf. Fig. 5(b)), distinct simplices can have the same boundary (cf. Fig. 5(c)). So, it is not always possible to directly associate an abstract simplicial complex with a semi-simplicial set, but the converse is true: given an abstract simplicial complex, we can define an order on the

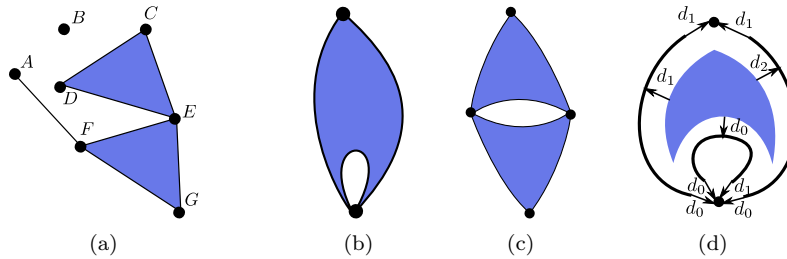

Figure 5: (a) An abstract simplicial complex. (b) The triangle is incident to two vertices. (c) Two edges have the same boundary. These two subdivisions can be described by semi-simplicial sets but not by abstract simplicial complexes. (d) Semi-simplicial set associated with (b).

vertices, and associate a sequence of vertices with each simplex (note that this induces an orientation for the simplices). An abstract simplex is then associated with each sequence of vertices, and the boundary operators can directly be deduced from this ordering ⁸. At last, note that the geometric realization of an abstract simplicial complex is a simplicial complex whereas the geometric realization of a semi-simplicial set is a *CW-complex* [May67, Ago76].

2.3.2 Cellular structures defined as numbered simplicial structures

Abstract simplicial complexes associated with incidence graphs and semi-simplicial sets associated with combinatorial maps correspond both to numbered simplicial structures. This numbering induces a notion of cell and cellular objects correspond thus to simplicial objects structured into cells.

In an incidence graph, each node represents a k -cell. In the associated simplicial complex, it corresponds to a vertex numbered k . More generally, any sequence of incident cells corresponds to a simplex numbered by the dimensions of the cells (so any k -simplex is incident to $k+1$ distinct vertices having different numbers).

For example, Fig. 2(c) illustrates an incidence graph, Fig. 2(b) shows its simplicial interpretation, and Fig. 2(a) shows its corresponding cellular decomposition. In this example, 2-simplex σ is defined as the set $\{v_1, e_1, f_2\}$ and it is numbered $\{0, 1, 2\}$.

Regarding n -dimensional generalized maps, each orbit $\langle \rangle_{[0,n]-\{i_0, \dots, i_p\}}(d)$ is associated with a simplex numbered $\{i_0, \dots, i_p\}$. The semi-simplicial set associated with the gmap has thus its vertices numbered from 0 to n , and, for a given simplex, all its vertices have distinct numbers.

The main difference between combinatorial maps and incidence graphs is the fact that in the case of gmaps, two simplices may have the same boundary

⁸More precisely, for any i , face operator d_i is defined in such a way that it corresponds intuitively to remove the i^{th} vertex of the simplex.

(see Fig. 6(c)). Nevertheless, the principle of the topological interpretation of incidence graphs and gmaps is the same and it is based on the following definition:

Definition 2.8 (i -cell [Lie94]) *In a numbered simplicial object, an i -cell is defined by a vertex v numbered i and all the simplices of dimension 1 to i incident to v which are numbered by integers lower than i .*

It can be noticed that this definition of cells is very general: in particular, it allows to have cells the geometric realization of which are not topological balls (see Fig. 6(b)). To conclude, a cellular object is simply a numbered simplicial object, where the numbering defines a partition of the simplices into cells.

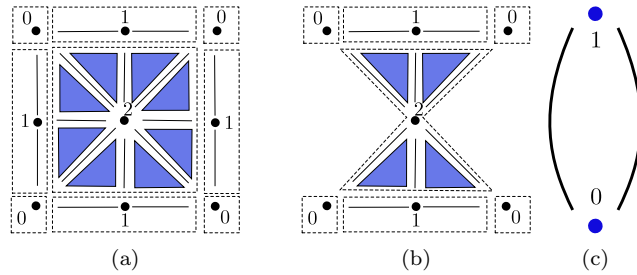

Figure 6: (a)-(b) Two numbered semi-simplicial sets structured into cells. On (a), each cell is a topological ball whereas on (b) the 2-cell is not even a manifold. (c) An edge incident twice to a vertex: two 1-simplices share the same boundary.

In order to restrict this generality, some authors have defined different subclasses of these cellular objects, in particular n -surfaces and cellular quasi-manifolds (cf. below). A slightly more general class is that of *numbered simplicial quasi-manifold*, which can be constructively defined in the following way: starting with n -simplices numbered 0 to n (and their boundaries), $(n - 1)$ -simplices are identified in such a way that at most 2 n -simplices are incident to an $(n - 1)$ -simplex. For example, the numbered semi-simplicial set on Fig. 6(b) is not a numbered simplicial quasi-manifold, since its construction needs to identify not only edges and their boundaries, but also single vertices.

Note that the representation can be simplified by keeping only the n -simplices and by replacing faces operators by adjacency operators. We then obtain a *premap* $(D, \alpha_0, \dots, \alpha_n)$, where each dart of D corresponds to an n -simplex, and all α operators correspond to adjacency relations of n -simplices. One can notice that cells may not be quasi-manifolds (see Fig. 7(b)).

Cellular quasi-manifolds are a subclass of numbered simplicial quasi-manifolds where the cells are also cellular quasi-manifolds. They can be characterized through two different ways:

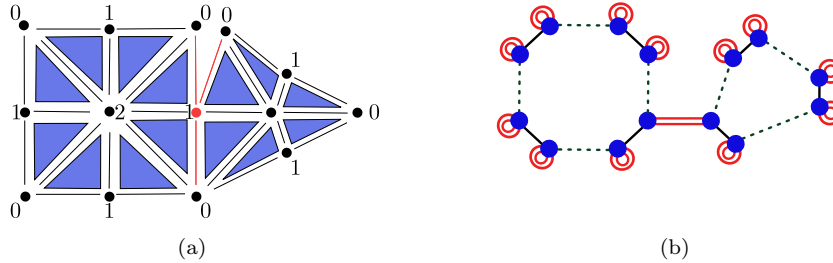

Figure 7: (a) A numbered simplicial quasi-manifold having a 1-cell which is not a quasi-manifold. (b) Its associated premap.

- through a characterization of the cell neighborhoods, as it is done for n -surfaces;
- constructively: a 0-dimensional cellular quasi-manifold is a collection of sets of one or two vertices. An n -dimensional cellular quasi-manifold containing isolated n -cells is obtained from an $(n - 1)$ -dimensional cellular quasi-manifold by cone operations over each connected component. The n -cells can then be glued together by identifying $(n - 1)$ -cells (and their boundaries) in such a way that there is at most two n -cells around an $(n - 1)$ -cell. We then come up to the definition of generalized maps: the fact that cells are cellular quasi-manifolds is ensured by the second condition over the α_i (i.e. $\alpha_i\alpha_j$ is an involution for all i, j s.t. $0 \leq i \leq j - 2 < j \leq n$).

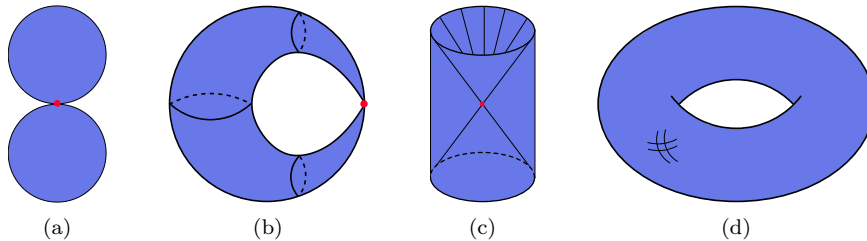

Figure 8: (a) A non manifold. (b) A pseudo-manifold (non quasi-manifold). (c) A quasi-manifold (non-manifold). This object can be obtained by gluing two opposite triangular faces of a square based pyramid. (d) A manifold.

At last, note that a cellular quasi-manifold may not be a manifold (see Fig. 8(c)), but it is a pseudo-manifold [Lie94].

So, we are now able to define cellular complexes in which the cells are cellular quasi-manifolds. For map structures, we obtain the notion of chain of maps (cf.

Section 4), whereas in the incidence graph context, we consider incidence graph in which all the subgraphs restricted to the main cells (and their boundaries) are i -surfaces (cf. Section 3). We can also consider a subclass, which corresponds to orientable cellular quasi-manifolds without boundary (cf. Section 8).

2.4 Problem

2.4.1 Simplicial homology

The definition of homology for simplicial objects is well-known: it consists in defining the chain groups (which is straightforward) and the boundary operators. These boundary operators are defined as linear extensions of basic boundary operators which act on simplices. For abstract simplicial complexes, we can define an homology on $\mathbb{Z}/2\mathbb{Z}$ by defining the basic boundary operator in the following way: $\{v_0, \dots, v_i, \dots, v_k\}\partial = \sum_{0 \leq i \leq k} \{v_0, \dots, \hat{v}_i, \dots, v_k\}$ where \hat{v}_i means

that vertex v_i is removed. For semi-simplicial sets, as said before when comparing them with abstract simplicial complexes, simplices are implicitly oriented, and we can define an homology on \mathbb{Z} by defining the basic boundary operator as: $\sigma\partial = \sum (-1)^i \sigma d_i$. We will follow this idea later for defining an homology for cellular structures: first defining an homology on $\mathbb{Z}/2\mathbb{Z}$, then adding an orientation of the cells for defining an homology on \mathbb{Z} .

2.4.2 Cellular Homology

The homology of cellular objects (incidence graphs or ordered models) can be simply defined as their simplicial homology, since a cellular object is a simplicial object structured into cells. Our objective is to take advantage of this structuration into cells. So we are looking for some optimization by defining a boundary operator which acts directly on the cells (i.e. on sets of simplices). So the optimization acts on the number of elements that are considered as there are less cells than simplices in the associated topological interpretation. A boundary operator is commonly based upon the notion of *incidence number*: given two cells c^i (of dimension i) and c^{i-1} (of dimension $i-1$), the incidence number ($c^i : c^{i-1}$) is the number of times c^{i-1} appears in the boundary of c^i . A boundary operator is the linear extension of a basic boundary operator which acts on cells, defined by:

Definition 2.9 (boundary operator) *Let C^{i-1} denote the set of $(i-1)$ -cells, and c^i be an i -cell; the boundary operator ∂ associates the $(i-1)$ -chain:*

$$c^i\partial = \sum_{c^{i-1} \in C^{i-1}} (c^i : c^{i-1})c^{i-1}$$

So, we just have to focus on the definition of incidence numbers. For example, we have seen that we can define a boundary operator over abstract simplicial complexes with coefficients in $\mathbb{Z}/2\mathbb{Z}$. In the same way, it is possible to define a boundary operator with coefficients over $\mathbb{Z}/2\mathbb{Z}$ for incidence graphs by setting

$(c^i : c^{i-1})$ equals 1 if c^{i-1} is in the boundary of c^i , and 0 if it is not. Then, we need to study the conditions which have to be satisfied in order to define a true boundary operator (i.e. such that $\partial\partial = 0$), and the relationships between the cellular homology we have defined and the simplicial homology defined on the associated abstract simplicial complex.

Moreover, we expect here to define an homology with coefficients over \mathbb{Z} . The idea here is to proceed in the same way as it has been classically done for simplicial structures. In particular, we have to add an orientation of the cells. For this we need to add the following constraints over cells:

- cells are cellular quasi-manifolds;
- cells have complete boundaries (or else, there is no chance we can define a cellular boundary operator ∂ which satisfies $\partial\partial = 0$);
- cells are orientable (since it is necessary to define an orientation on them);
- the “canonical” boundary of each k -cell has the homology of a $(k - 1)$ -sphere. Actually, from a simplicial point of view, a k -cell is a cone over a $(k - 1)$ -quasi-manifold. From a cellular point of view, a cell fills its boundary. In order to have a chance to define a cellular homology equivalent to its simplicial interpretation, the cone operation has to have the same effects in the cellular structure as in the simplicial one. So, it is expected that a cone kills all the homology groups (except H_0), and the only way to ensure this property in the cellular structure is to perform cones over spheres.

In a first step, we detail this approach for incidence graphs where cells are n -surfaces. This approach is then extended to chains of maps, which can represent multi-incidence. Finally, we study possible optimizations for subclasses of chains of maps (gmaps and maps).

In the sequel, each boundary operator is denoted by the letter ∂ together with a subscript corresponding to the initial of the name of the structure on which it is defined, i.e. ∂_S , ∂_G and ∂_M respectively stand for simplicial structures, incidence graphs and maps. Note that no specific notation is used to distinguish between boundary operators acting on \mathbb{Z} or $\mathbb{Z}/2\mathbb{Z}$. The context is sufficient to achieve this distinction.

3 Incidence graphs

We first describe in this section the subclass of incidence graphs we are interested in and highlight some of their properties. We define then the notion of unsigned incidence number and prove that it is consistent with the construction of a boundary operator with coefficients belonging to $\mathbb{Z}/2\mathbb{Z}$. We go on explaining how to detect whether a cell of such a subdivision is orientable or not and we define a signed incidence number for any pair of oriented cells having consecutive dimensions. We prove that this definition induces a boundary operator with

coefficients in \mathbb{Z} and hence a homology over \mathbb{Z} . We provide then an algorithm computing all incidence matrices of an incidence graph belonging to the subclass we consider. The proof of the equivalence between this cellular homology and the traditional simplicial one is postponed to Section 6.

3.1 Definition

Elementary notions related to incidence graphs have been recalled in Section 2.2.1. We focus here on a subclass of incidence graphs more general than n -surfaces. Such incidence graphs actually encode subdivisions that are not cellular quasi-manifolds but whose cells are (see an example on Figure 9).

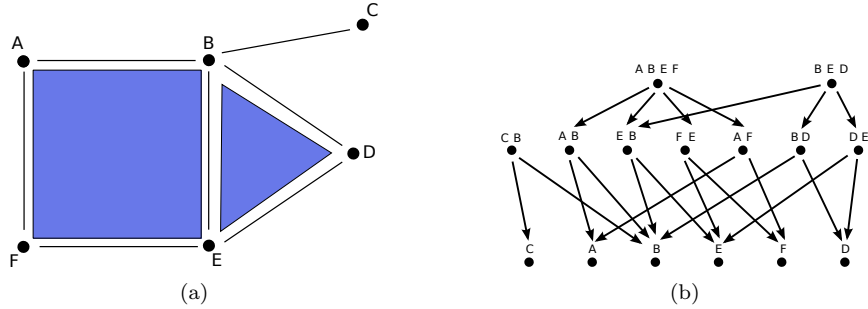

Figure 9: (a) Cell subdivision. (b) Its associated incidence graph which is a 2-dimensional chain of surfaces.

In the remaining of the paper, the symbol representing an element of an order is superscripted by its rank whenever the dimension of the element has to be taken into account.

Definition 3.1 (chain of surfaces) Let $|X| = (X, \alpha)$ be a non-empty connected CF -order. $|X|$ is a k -dimensional chain of surfaces if $\forall x^i$ main cell of $|X|$, $\alpha^\square(x^i)$ is an $(i - 1)$ -surface.

This subclass of incidence graphs inherits some interesting properties of n -surfaces. First, whenever a $(k - 2)$ -cell is incident to a k -cell, there exists exactly two $(k - 1)$ -cells between them (*diamond configuration*). Similarly any 1-cell has exactly two incident 0-cells. To obtain an homogeneous definition of this so-called *switch-property* [Bri93], a fictive element x^{-1} is added to X such that x^{-1} belongs to the α -adherence of any element of X (i.e. x^{-1} is a sink for $|X|$).

Property 3.2 (switch-property) Let $|X|$ be a k -dimensional chain of surfaces.

$\forall (x, y) \in (X \cup \{x^{-1}\}) \times (X \cup \{x^{-1}\})$, $\beta^\bullet(x) \cap \alpha^\bullet(y)$ is either empty or made of exactly 2 elements.

On n -surfaces, the **switch**-property also holds for $(n - 1)$ -elements and a fictive source x^{n+1} . Moreover this property induces $(n + 1)$ operators on n - β^\bullet -chains, denoted by \mathbf{switch}_i , $i \in \{0, \dots, n\}$, each of which acts on the i -dimensional element of the chain. The operator \mathbf{switch}_i actually transforms the chain $(x^0, \dots, x^{i-1}, x^i, x^{i+1}, \dots, x^n)$ into $(x^0, \dots, x^{i-1}, x^i, x^{i+1}, \dots, x^n)$, where $\beta^\bullet(x^{i-1}) \cap \alpha^\bullet(x^{i+1}) = \{x^i, x^i\}$ (see [Bri93]).

Property 3.3 *Let $|X|$ be a k -dimensional chain of surfaces and x^i be an element of X . The suborder built on all elements of $\alpha^\square(x^i)$ having dimensions $(i - 2)$ and $(i - 1)$ is connected.*

Proof. $|\alpha^\square(x^i)|$ is an $(i - 1)$ -surface (see proof in [DCB05]). Then it is chain-connected (see [ADLL08]), which means that any two $(i - 1)$ - β^\bullet -chains having k elements in common can be obtained from one another by a composition of **switch**-operators involving elements that are not shared by both chains.

Let y and z be two elements belonging to the suborder of $|\alpha^\square(x^i)|$ built on $(i - 1)$ - and $(i - 2)$ -elements. We show that there exists a path in this very suborder linking both elements by building it step by step. Let C_y and C_z be two $(i - 1)$ - β^\bullet -chains respectively containing y and z . Note that each such chain contains exactly two elements of the suborder. If $y \in C_z$ or $z \in C_y$, then y and z are connected. Else, as $|\alpha^\square(x^i)|$ is chain-connected, C_z is the image of C_y under a composition of \mathbf{switch}_k operators. This composition of involutions contains at least one \mathbf{switch}_{i-1} or one \mathbf{switch}_{i-2} involution. Let C'_y be the image of C_y by the subsequence of consecutive involutions ending with the first involution whose index, k_0 , is equal to $i - 1$ or $i - 2$. And let C_y^0 the chain obtained by applying the same sequence of operators and ending with the involution preceding \mathbf{switch}_{k_0} . In the following let us denote respectively by y^{i-3} , y^{i-2} and y^{i-1} the $(i - 3)$ -, $(i - 2)$ - and $(i - 1)$ -cells of C_y^0 . Note that both y^{i-2} and y^{i-1} belong to the suborder of $|\alpha^\square(x^i)|$ built on its $(i - 1)$ - and $(i - 2)$ -elements and that y is either y^{i-1} or y^{i-2} .

Let y^{k_0} be the k_0 -dimensional element of C'_y . If k_0 is equal to $i - 1$, then, y^{i-2} belongs both to C'_y and to C_y^0 . And $y^{k_0} = \alpha^\bullet(x^i) \cup \beta^\bullet(y^{i-2}) \setminus \{y^{i-1}\}$. The chain $y^{i-1}, y^{i-2}, y^{k_0}$ is a path in the suborder. If k_0 is equal to $i - 2$, then y^{i-1} still belongs to C'_y . Moreover $y^{k_0} = \alpha^\bullet(y^{i-1}) \cup \beta^\bullet(y^{i-3}) \setminus \{y^{i-2}\}$ and $y^{i-2}, y^{i-1}, y^{k_0}$ is a path in the suborder. There exists hence a path between y and y^{k_0} . If $y^{k_0} = z$ then we are done. Else we go on applying involutions and building a path step by step. \square

3.2 Unsigned incidence number

The unsigned incidence number counts the number of times a cell is incident to another. As subdivisions encoded by incidence graphs cannot contain any

multi-incidence, the value of the unsigned incidence number for any couple of consecutive cells is either 1 or 0, depending on whether one cell belongs to the boundary of the other or not.

Definition 3.4 (unsigned incidence number) *Let $|X|$ be a k -dimensional chain of surfaces, let x^i and x^{i-1} be two elements of X , the unsigned incidence number, $(x^i : x^{i-1})$ is defined to be equal to 1 if $x^{i-1} \in \alpha^\bullet(x^i)$, else it is equal to 0.*

Let us recall that ∂_G denotes here the operator built from the unsigned incidence number as a linear extension over $\mathbb{Z}/2\mathbb{Z}$ of the basic operator described in definition 2.9.

Theorem 3.5 ∂_G is a boundary operator (i.e. $\partial_G \partial_G = 0$).

Proof. Let x^i be an element of a k -dimensional chain of surfaces:

$$\begin{aligned} x^i \partial_G &= \sum_{x^{i-1} \in \alpha^\bullet(x^i)} x^{i-1} \\ x^i \partial_G \partial_G &= \sum_{x^{i-1} \in \alpha^\bullet(x^i)} (x^{i-1} \partial_G) \\ &= \sum_{x^{i-1} \in \alpha^\bullet(x^i)} \sum_{x^{i-2} \in \alpha^\bullet(x^{i-1})} x^{i-2} \end{aligned}$$

The switch-property says that each element x^{i-2} incident to x^i , is incident to exactly two $(i-1)$ -elements of $\alpha^\bullet(x^i)$. It implies that each $(i-2)$ -element involved in the double sum above is present exactly twice, one for each $(i-1)$ -element it is incident to. As coefficients of ∂_G belong to $\mathbb{Z}/2\mathbb{Z}$, the sum is hence equal to 0. \square

3.3 Signed incidence number

The signed incidence number describes not only the number of times a cell is incident to another but also the relative orientations of both cells. It has hence to be defined on subdivisions whose cells can have an orientation.

Definition 3.6 (oriented cell) *Let $|X|$ be a k -dimensional chain of surfaces, and x^i be an element of $|X|$, x^i is oriented by adding a + or - mark on each α^\bullet -relation. The marked α^\bullet -relation between x^i and x^{i-1} is denoted by $sg(x^i, x^{i-1})$ ⁹. The inductive orientation process is:*

$\forall i \geq 2, \forall x^{i-2} \in \alpha(x^i)$, let $\{x^{i-1}, x'^{i-1}\} = \beta^\square(x^{i-2}) \cap \alpha^\square(x^i)$, then

$$sg(x^i, x^{i-1}).sg(x^{i-1}, x^{i-2}) = -sg(x^i, x'^{i-1}).sg(x'^{i-1}, x^{i-2})$$

⁹According to the context, the value of $sg(x^i, x^{i-1})$ is + or -, or +1 or -1.

All possible diamond configurations are displayed on Figure 10. If such a mark cannot be consistently added on each α^\bullet -relation, then there exists at least one cell of the subdivision which is not orientable. If a cell is orientable, then it can be equipped with two different orientations.

On subdivisions represented by incidence graphs where cells cannot be multiply incident to each other, the value of the signed incidence number between two cells is equal to either -1 , 1 , or 0 .

Definition 3.7 (signed incidence number) *Let $|X|$ be a k -dimensional chain of surfaces. Let x^i and x^{i-1} be two oriented elements of X , the incidence number, $(x^i : x^{i-1})$ is equal to 0 if $x^{i-1} \notin \alpha^\bullet(x^i)$, else $(x^i : x^{i-1}) = sg(x^i, x^{i-1})$.*

Let us recall that ∂_G denotes here the operator built from the incidence number as a linear extension over \mathbb{Z} of the basic operator described in definition 2.9.

Theorem 3.8 ∂_G is a boundary operator (i.e. $\partial_G \partial_G = 0$).

Proof. Let x^i be an element of a k -dimensional chain of surfaces:

$$\begin{aligned} x^i \partial_G &= \sum_{x^{i-1} \in \alpha^\bullet(x^i)} (x^i : x^{i-1}) x^{i-1} \\ x^i \partial_G \partial_G &= \sum_{x^{i-1} \in \alpha^\bullet(x^i)} ((x^i : x^{i-1}) x^{i-1} \partial_G) \\ &= \sum_{x^{i-1} \in \alpha^\bullet(x^i)} (x^i : x^{i-1}) \sum_{x^{i-2} \in \alpha^\bullet(x^{i-1})} (x^{i-1} : x^{i-2}) x^{i-2} \\ &= \sum_{x^{i-1} \in \alpha^\bullet(x^i)} \sum_{x^{i-2} \in \alpha^\bullet(x^{i-1})} (x^i : x^{i-1}) (x^{i-1} : x^{i-2}) x^{i-2} \end{aligned}$$

As previously, the **switch-property** says that each element x^{i-2} incident to x^i is incident to exactly two $(i-1)$ -elements of $\alpha^\bullet(x^i)$. It implies that each $(i-2)$ -element involved in the double sum above is present exactly twice, one for each $(i-1)$ -element it is incident to. Let x^{i-1} and x'^{i-1} be these two elements. The coefficient of x^{i-2} in $x^i \partial_G \partial_G$ is hence $(x^i : x^{i-1})(x^{i-1} : x^{i-2}) + (x^i : x'^{i-1})(x'^{i-1} : x^{i-2})$ which by definition is equal to 0 , since the cells are oriented ones. □

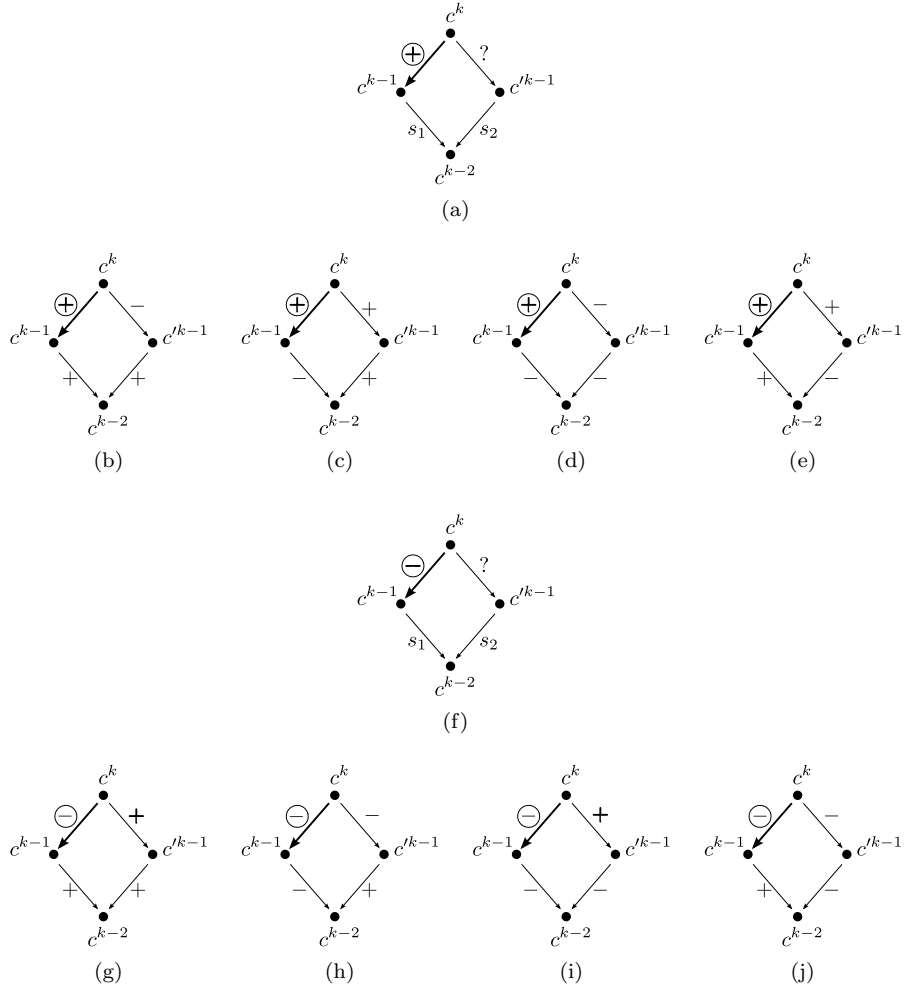

Figure 10: Diamond configurations related to **switch**-property.

3.4 Algorithm

The signed incidence number linking two incident cells is directly deduced from their relative orientation. Hence such incidence numbers can be computed while assigning an orientation to each cell of the subdivision. Therefore, the computations of orientations and of incidence matrices are achieved during the same traversal of the graph. Note that if the algorithm detects a non orientable cell, it stops immediately with an error message. Moreover all diamonds configurations have to be checked in order to be sure that a cell is orientable.

Detecting whether a cell x^i of a k -dimensional chain of surfaces is orientable or not and, in the first case, giving an orientation to it, is simply achieved by

following definition 3.6:

- Fix a sign in the boundary of x^i , i.e. mark an α^\bullet -relation with sign '+' for instance;
- Go through all $(i-1)$ -cells of $\alpha^\bullet(x^i)$ by looking at all diamonds having at least one signed branch (see Figure 10).

Two cases may occur:

1. One branch in the diamond has not yet been equipped with a sign. Its sign is computed applying definition 3.6;
2. Both branches are already signed. If signs are not consistent, then a non orientable cell has been detected.

This process is implemented by Procedure *compute_Eⁱ_Row* (page 26), which computes the orientation of an i -cell and the corresponding row of the i^{th} incidence matrix. It uses orientation information about $(i-1)$ -cells belonging to the boundary of the considered i -cell by looking at the $(i-1)^{\text{th}}$ incidence matrix. More precisely, for a given i -cell, x^i , of the subdivision, an element, x^{i-1} , of its α^\bullet -adherence is arbitrarily picked and the corresponding incidence number is set to 1. Then all diamonds rooted at x^i are traversed, one after another.

The traversal has to grant that at least one branch of the current diamond has already a sign (to be able to complete the signing) and that all diamonds are traversed in a finite number of steps. Note that each $(i-2)$ -element of $\alpha(x^i)$ belongs to exactly one such diamond in $\alpha(x^i)$ (due to **switch**-property). Moreover, property 3.3 guarantees that the suborder built on all these diamonds is connected. Hence, traversing all diamonds is equivalent to going through the set of $(i-2)$ -elements and examining each one of them exactly once. Both previous properties allow thus to traverse all diamond configurations following a suitable ordering by constructing step by step the set of $(i-2)$ -elements belonging to $\alpha(x^i)$ as the union of the α^\bullet -adherences of already hit x^{i-1} of $\alpha^\bullet(x^i)$. The algorithm ends when a fully signed diamond is hit and there is no other $(i-2)$ -cell left.

For instance, the orientation process of cell $ABEF$ belonging to the subdivision displayed on Figure 11 is illustrated on Figure 12. Let us first suppose the 0-cells and 1-cells oriented as indicated. Step 1 (Fig. 12(a)): Pick any cell in the α^\bullet -adherence of $ABEF$ and mark the corresponding relation with a +. Let us choose, for instance, AB . The set of 0-cells is hence initialized with $\{A, B\}$. Step 2 (Fig. 12(b)): Let us choose A as the first 0-cell to deal with. The α^\bullet -relation between $ABEF$ and AF is marked according to **switch**-property. And the set of 0-cells to explore is updated: A is removed and F is added. Step 3 (Fig. 12(c)): One of these cells is arbitrarily chosen: F for instance. The missing mark on the diamond delimited by F and $ABEF$ is added (on the relation between $ABEF$ and FE). F is removed from the set of 0-cells and E is added. Step 4 (Fig. 12(d)): Let us choose B as the next 0-cell. The missing mark on the diamond delimited by B and $ABEF$ is added (on the relation between $ABEF$ and EB). Step 5 (Fig. 12(e)): No new cell is added to the set of 0-cells

as E already belongs to it. There is only one cell left in the set of 0-cells. The diamond delimited by $ABEF$ and E is already signed. The consistency of the signing is checked and the algorithm comes to an end.

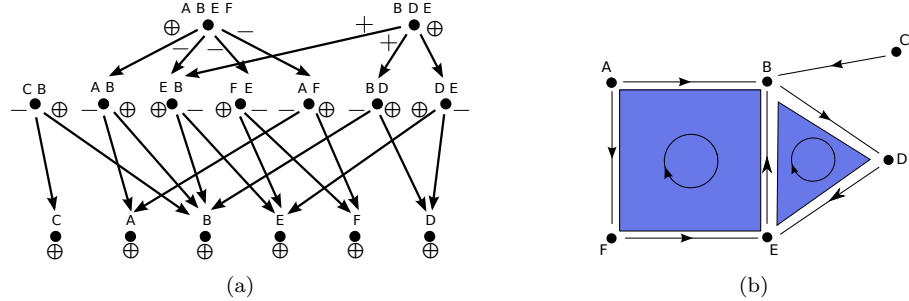

Figure 11: (a) Orientation of the cells of a 2-dimensional chain of surfaces. (b) Corresponding orientation of the cells of the associated subdivision.

Then the algorithm, we provide to compute all incidence matrices of the incidence graph (see Algorithm 1 page 28), begins with elements of rank 0 and successively computes the incidence of every element of rank i for i growing from 0 to the dimension of the subdivision.

To initialize the process, each 0-element is equipped with a positive orientation by assigning the value 1 to the incidence relation between each 0-element and x^{-1} . While traversing $\beta^\bullet(x^{-1})$ to treat all 0-elements, the set of 1-elements is also computed by aggregating the β^\bullet -adherences of every 0-element.

As previously the set of $(i+1)$ -elements is built when dealing with i -elements by aggregating their β^\bullet -adherences.

The cellular homology of a n -dimensional chain of surfaces computed with the above defined cellular boundary operator is equivalent to the simplicial homology of the associated numbered simplicial complex. The proof is established in Section 6 in two steps. First n -dimensional chains of surfaces are proved to be equivalent to a subclass of chains of maps. Then results, obtained in Section 5, about the equivalence of the cellular homology computed on chains of maps and the simplicial homology of their associated semi-simplicial sets are applied.

4 Chain of maps

4.1 Definition

As for incidence graphs, we focus here on structures in which the main cells are cellular quasi-manifolds: so, the cells are represented by generalized maps, and they are linked by a face operator (cf. Fig. 13 and [EL94]).

Definition 4.1 (chain of maps) *An n -dimensional chain of maps is a tuple $C = ((G^i)_{i=0,\dots,n}, (\sigma^i)_{i=1,\dots,n})$ such that:*

Procedure *compute_Eⁱ_Row*(c^i, E^{i-1});

Computation of the row of the i^{th} incidence matrix of an n -dimensional chain of surfaces corresponding to a given i -cell, c^i . The algorithm detects whether each cell is orientable. If this condition is not fulfilled the algorithm stops with an information message.

Data:

$GI = (X \cup \{x^{-1}\}, \alpha^\bullet, \beta^\bullet)$;

c^i : i -cell of GI ;

E^{i-1} : incidence matrix describing the incidence relations between $(i-1)$ - and $(i-2)$ -cells;

Result:

$E^i(c^i, *)$: row of E^i describing the incidence relations of c^i ;

Variables:

$c^{i-1}, c^{i-1'}$: $(i-1)$ -cells belonging to $\alpha^\bullet(c^i)$;

lesser_C: $(i-2)$ -cells belonging to the boundary of the current i -cell;

```

1  $c^{i-1} \leftarrow \text{pickCell}(\alpha^\bullet(c^i))$ ;
2  $E^i(c^i, c^{i-1}) \leftarrow 1$ ;
3  $\text{lesser\_C} \leftarrow \alpha^\bullet(c^{i-1})$ ;
4 while ( $\text{lesser\_C} \neq \emptyset$ ) do
5    $c^{i-2} \leftarrow \text{pickCell}(\text{lesser\_C})$ ;
6    $(c^{i-1}, c^{i-1'}) \leftarrow \beta^\bullet(c^{i-2}) \cap \alpha^\bullet(c^i)$ ;
7   if  $E^i(c^i, c^{i-1})$  not defined then
8      $\text{swap}(c^{i-1}, c^{i-1'})$ ;
9   end
10  if  $E^i(c^i, c^{i-1'})$  not defined then
11     $E^i(c^i, c^{i-1'}) \leftarrow$ 
12     $(-1) * E^i(c^i, c^{i-1}) * E^{i-1}(c^{i-1}, c^{i-2}) * E^{i-1}(c^{i-1'}, c^{i-2})$ ;
13     $\text{lesser\_C} \leftarrow \text{lesser\_C} \cup \alpha^\bullet(c^{i-1'}) \setminus \{c^{i-2}\}$ ;
14  else
15    if  $E^i(c^i, c^{i-1'}) * E^{i-1}(c^{i-1'}, c^{i-2}) \neq -E^i(c^i, c^{i-1}) * E^{i-1}(c^{i-1}, c^{i-2})$ 
16      then
17        exit(the cell is non orientable.) ;
18      end
19     $\text{lesser\_C} \leftarrow \text{lesser\_C} \setminus \{c^{i-2}\}$ ;
20  end
21 end

```

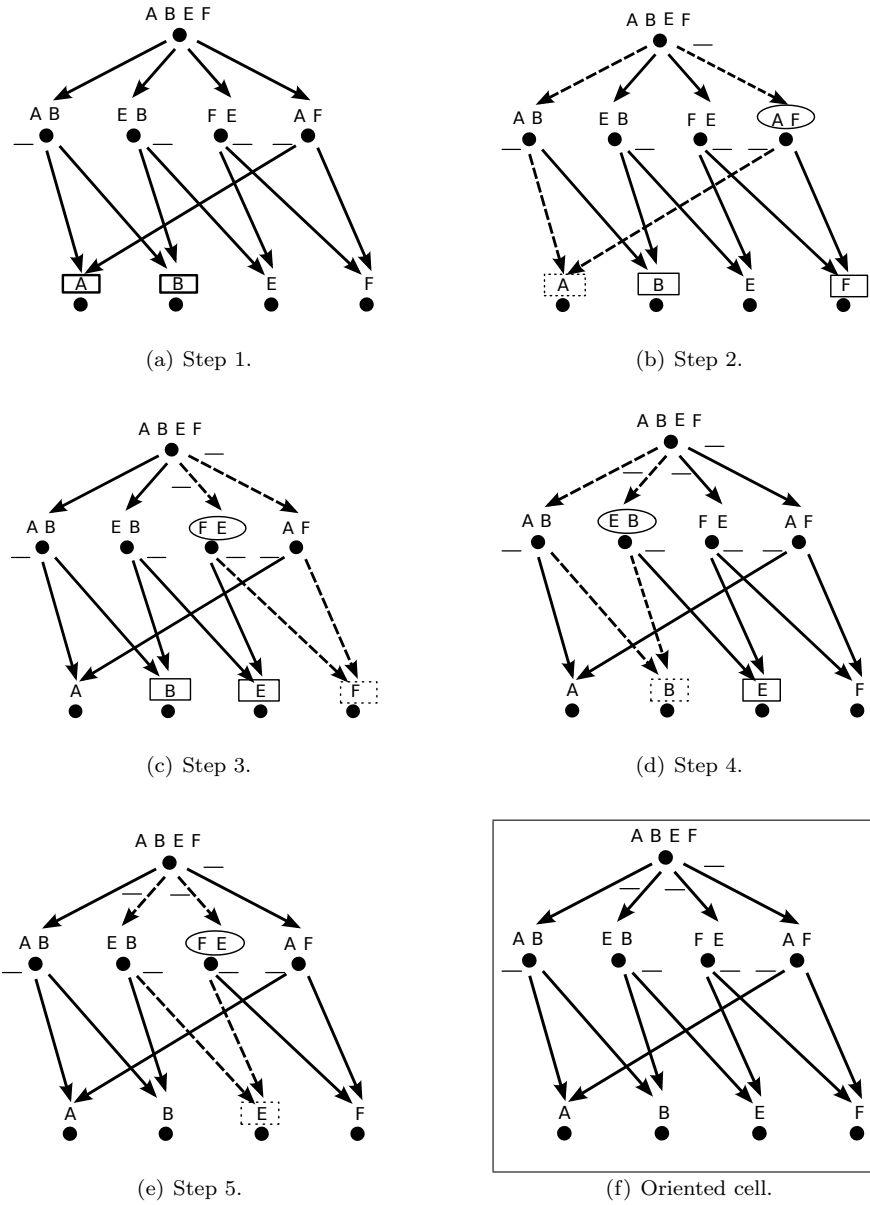

Figure 12: Orientation process of $ABEF$.

1. $\forall i, 0 \leq i \leq n, G^i = (D^i, \alpha_0^i, \dots, \alpha_{i-1}^i, \alpha_i^i = \omega)$ is an i -dimensional generalized map such that ω is undefined on D^i ;
2. $\forall i, 1 \leq i \leq n, \sigma^i : D^i \longrightarrow D^{i-1}$;

Algorithm 1: Computation of incidence matrices of an n -dimensional chain of surfaces. The algorithm detects whether each cell is orientable. If this condition is not fulfilled the algorithm stops with an information message.

Data: $GI = (X \cup \{x^{-1}\}, \alpha^\bullet, \beta^\bullet)$
Result: Incidence Matrices: $\{E^i, i = 0 \dots n\}$
Variables:
 i : dimension of the current matrix ;
 C : set of i -cells ;
 $greater_C$: set of $(i + 1)$ -cells ;
 c^i : current i -cell whose boundary is computed ;

```

1  $C \leftarrow \emptyset$ ;
2 foreach  $c \in \beta^\bullet(x^{-1})$  do
3    $E^0(c, x^{-1}) \leftarrow 1$ ;
4    $C \leftarrow C \cup \beta^\bullet(c)$ ;
5 end
6  $greater\_C \leftarrow \emptyset$ ;
7  $i \leftarrow 1$  ;
8 while  $(C \neq \emptyset)$  do
9    $c^i \leftarrow \text{pickCell}(C)$  ;
10   $C \leftarrow C \setminus \{c^i\}$  ;
11   $greater\_C \leftarrow greater\_C \cup \beta^\bullet(c^i)$ ;
12   $\text{compute\_E}^i\_Row(c^i, E^{i-1})$  ;
13  if  $C = \emptyset$  then
14     $C \leftarrow greater\_C$  ;
15     $i \leftarrow i + 1$  ;
16  end
17 end

```

for $i \geq 2$, σ^i satisfies, for any dart d of D^i :

- (a) σ^i is an isomorphism¹⁰ between any orbit $\langle \alpha_0^i, \dots, \alpha_{i-2}^i \rangle$ of G^i and an orbit $\langle \alpha_0^{i-1}, \dots, \alpha_{i-2}^{i-1} \rangle$ of G^{i-1} ;
- (b) $d\alpha_{i-1}^i \sigma^i \sigma^{i-1} = d\sigma^i \sigma^{i-1}$.

Any connected component of an i -gmap is an i -cell: in fact, it describes the *interior* of an i -cell, that is why $\alpha_i^i = \omega$ is undefined. This is consistent with the simplicial interpretation defined with more details in Section 5: any orbit $\langle \rangle_{[0,i]-\{j_0, \dots, j_k, i\}}$ is well defined, since α_i^i is not taken into account, and it corresponds to a simplex incident to the vertex representative of the cell (i.e. corresponding to the orbit $\langle \rangle_{I-\{i\}}$). Any i -cell can be structured into orbits

¹⁰i.e. σ^i is a one-to-one mapping between the darts of the orbits, such that for any $j, 0 \leq j \leq i-2$, $\alpha_j^i \sigma^i = \sigma^i \alpha_j^{i-1}$. This condition is more restrictive than that given in [EL94], where σ^i can be an homomorphism for instance.

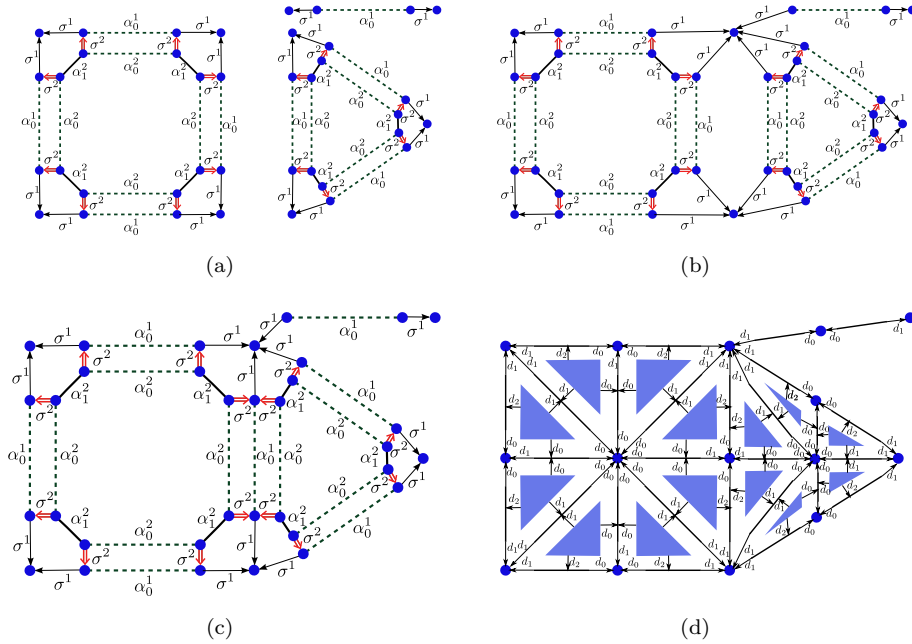

Figure 13: (a) First step for building a chain of maps of dimension 2: each chain of map corresponding to a main cell and its boundary is built. (b) Second step: vertex identifications. (c) The resulting chain of maps after edge identification. (d) The associated semi-simplicial set.

$\langle \alpha_0^i, \dots, \alpha_{i-2}^i \rangle$; these orbits are linked with $(i-1)$ -cells by operator σ^i , defining the boundary of the i -cell. For instance, the faces of the object represented Fig. 13 are structured in order to correspond to the edges of their boundaries: more precisely, the faces (i.e. orbits $\langle \alpha_0^2, \alpha_1^2 \rangle$) can be partitionned into orbits $\langle \alpha_0^2 \rangle$, which are linked with edges (i.e. orbits $\langle \alpha_0^1 \rangle$) by σ^2 . The fact that $\forall i$, σ^i restricted to an orbit $\langle \alpha_0^i, \dots, \alpha_{i-2}^i \rangle$ is an isomorphism between this orbit and an $(i-1)$ -cell implies that there is a strong correspondence between the structure of the interior of a cell and the structure of its boundary, even when cells are multi-incident ones to the others ¹¹.

4.2 Unsigned boundary operator

We can define the *incidence numbers* in the following way: the number of times an $(i-1)$ -cell c^{i-1} appears in the boundary of an i -cell c^i is, given a dart d^{i-1} of c^{i-1} , the number of darts of c^i which have d^{i-1} as image by σ^i . Since σ^i

¹¹From a practical point of view, it means that there exists some redundancy which can be taken into account in order to reduce the amount of explicit information within a data structure.

restricted to an orbit $\langle \alpha_0^i, \dots, \alpha_{i-2}^i \rangle$ is an isomorphism between this orbit and an $(i-1)$ -cell (cf. property 2a of definition 4.1), this number is the same whereas the chosen dart d^{i-1} is ¹². So the following definition is consistent.

Definition 4.2 (unsigned incidence number) *Let $i \in \{1, \dots, n\}$. Let c^i and c^{i-1} be two cells of the chain of maps C . The unsigned incidence number is*

$$(c^i : c^{i-1}) = (c^i(d^i) : c^{i-1}(d^{i-1})) = \text{card}((\sigma^i)^{-1}(d^{i-1}) \cap c^i(d^i))$$

where d^i and d^{i-1} are darts of respectively c^i and c^{i-1} .

Also due to property 2a of definition 4.1, this number is equal to the number of orbits $\langle \alpha_0^i, \dots, \alpha_{i-2}^i \rangle$ of c^i which have c^{i-1} as image (since each dart which image by σ^i is d^{i-1} identifies such an orbit). An alternative definition of the incidence number is then the following: let $\{p_j\}_{j=1 \dots k}$ be a set of darts such that the orbits $\{\langle \alpha_0^i, \dots, \alpha_{i-2}^i \rangle(p_j)\}_{j=1 \dots k}$ make a partition of c^i ; then $(c^i : c^{i-1}) = \text{card}(\{p_j, j = 1 \dots k / p_j \sigma^i \in c^{i-1}\})$. Let ∂_M be the corresponding boundary operator, according to definition 2.9. So we have $c^i \partial_M = \sum_{c^{i-1} \in C^{i-1}} (c^i : c^{i-1}) c^{i-1} = \sum_{p_j, j=1 \dots k} c^{i-1}(p_j \sigma^i)$, and the sum is done upon $\mathbb{Z}/2\mathbb{Z}$. Operator ∂_M is extended upon any sum of cells by linearity.

A condition has to be added in order to get a boundary operator, i.e. such that $\partial_M \partial_M = 0$: the boundary of each cell has to be “complete”, and this condition is expressed by the fact that α involutions are without fixed points ¹³.

Theorem 4.3 *Let C be a chain of maps such that all involutions are without fixed points. Then the corresponding operator ∂_M is a boundary operator.*

The proof of the theorem is based upon the following lemma.

Lemma 4.4 *Let c^i be any i -cell, and d be any dart of c^i . Then $\langle \alpha_0^i, \dots, \alpha_{i-3}^i \rangle(d) \neq \langle \alpha_0^i, \dots, \alpha_{i-3}^i \rangle(d\alpha_{i-1}^i)$.*

Proof. *The proof of the lemma is based upon the fact that involutions are without fixed points, and on the properties 2a and 2b of the chain of maps definition.*

More precisely, we know that $d \neq d\alpha_{i-1}^i$, since all involutions are without fixed points. Assume $\langle \alpha_0^i, \dots, \alpha_{i-3}^i \rangle(d) = \langle \alpha_0^i, \dots, \alpha_{i-3}^i \rangle(d\alpha_{i-1}^i)$. So $\langle \alpha_0^{i-1}, \dots, \alpha_{i-3}^{i-1} \rangle(d\sigma^i) = \langle \alpha_0^{i-1}, \dots, \alpha_{i-3}^{i-1} \rangle(d\alpha_{i-1}^i \sigma^i)$.

- Assume $d\alpha_{i-1}^i \sigma^i = d\sigma^i$. Since σ^i restricted to any orbit $\langle \alpha_0^i, \dots, \alpha_{i-2}^i \rangle$ is an isomorphism, σ^i restricted to any orbit $\langle \alpha_0^i, \dots, \alpha_{i-3}^i \rangle$ is also an isomorphism, and we get a contradiction : dart $d\sigma^i$ has two distinct preimages which are d and $d\alpha_{i-1}^i$ in a single orbit $\langle \alpha_0^i, \dots, \alpha_{i-3}^i \rangle(d)$;

¹²In fact, the property still holds for homomorphisms.

¹³i.e. $\forall i, 0 \leq i \leq n, \forall j, 0 \leq j \leq i-1, \forall d \in D^i, d \neq d\alpha_j^i$.

- So $d\alpha_{i-1}^i\sigma^i \neq d\sigma^i$. But we have $d\alpha_{i-1}^i\sigma^i\sigma^{i-1} = d\sigma^i\sigma^{i-1}$ (cf. property 2b of definition 4.1). Thus $d\sigma^i\sigma^{i-1}$ has two distinct preimages $d\alpha_{i-1}^i\sigma^i$ and $d\sigma^i$ within a single orbit $\langle \alpha_0^{i-1}, \dots, \alpha_{i-3}^{i-1} \rangle (d\sigma^i)$: contradiction with the fact that σ^{i-1} restricted to any orbit $\langle \alpha_0^{i-1}, \dots, \alpha_{i-3}^{i-1} \rangle$ is an isomorphism.

□

Proof. In order to prove theorem 4.3, let $c^i = \langle \alpha_0^i, \dots, \alpha_{i-1}^i \rangle (d)$ be an i -cell, and let $\{p_j\}_{j=1\dots k}$ be a set of darts such that the orbits $\{\langle \alpha_0^i, \dots, \alpha_{i-2}^i \rangle (p_j)\}_{j=1\dots k}$ make a partition of c^i . $c^i\partial_M = \sum_{p_j, j=1\dots k} c^{i-1}(p_j\sigma^i)$, where $c^{i-1}(p_j\sigma^i) = \langle \alpha_0^{i-1}, \dots, \alpha_{i-2}^{i-1} \rangle (p_j\sigma^i)$. For each p_j , let $\{p_{j,m}\}_{m=1\dots l_j}$ be a set of darts such that the orbits $\{\langle \alpha_0^{i-1}, \dots, \alpha_{i-3}^{i-1} \rangle (p_{j,m})\}_{m=1\dots l_j}$ make a partition of $c^{i-1}(p_j\sigma^i)$. So $c^i\partial_M\partial_M = \sum_{p_j, j=1\dots k} (c^{i-1}(p_j\sigma^i))\partial_M = \sum_{p_j, j=1\dots k} \sum_{p_{j,m}, m=1\dots l_j} c^{i-2}(p_{j,m}\sigma^{i-1})$, where $c^{i-2}(p_{j,m}\sigma^{i-1}) = \langle \alpha_0^{i-2}, \dots, \alpha_{i-3}^{i-2} \rangle (p_{j,m}\sigma^{i-1})$. Since σ^i is a one-to-one mapping between orbits $\langle \alpha_0^i, \dots, \alpha_{i-2}^i \rangle (p_j)$ and $\langle \alpha_0^{i-1}, \dots, \alpha_{i-2}^{i-1} \rangle (p_j\sigma^i)$, let $\{p'_{j,m}\}_{m=1\dots l_j}$ be the set of darts of $\langle \alpha_0^i, \dots, \alpha_{i-2}^i \rangle (p_j)$ such that $p'_{j,m}\sigma^i = p_{j,m}$. The orbits $\{\langle \alpha_0^i, \dots, \alpha_{i-3}^i \rangle (p'_{j,m})\}_{m=1\dots l_j}$ make a partition of $\langle \alpha_0^i, \dots, \alpha_{i-2}^i \rangle (p_j)$ and thus $c^i\partial_M\partial_M = \sum_{p_j, j=1\dots k} \sum_{p'_{j,m}, m=1\dots l_j} \langle \alpha_0^{i-2}, \dots, \alpha_{i-3}^{i-2} \rangle (p'_{j,m}\sigma^i\sigma^{i-1})$.

Moreover, the set of orbits $\{\langle \alpha_0^i, \dots, \alpha_{i-3}^i \rangle (p'_{j,m})\}_{j=1\dots k, m=1\dots l_j}$ make a partition of c^i . Since for all j, m , $\langle \alpha_0^i, \dots, \alpha_{i-3}^i \rangle (p'_{j,m}) \neq \langle \alpha_0^i, \dots, \alpha_{i-3}^i \rangle (p'_{j,m}\alpha_{i-1}^i)$ (cf. lemma 4.4), and $p'_{j,m}\sigma^i\sigma^{i-1} = p'_{j,m}\alpha_{i-1}^i\sigma^i\sigma^{i-1}$ (cf. property 2b of definition 4.1), $\langle \alpha_0^{i-2}, \dots, \alpha_{i-3}^{i-2} \rangle (p'_{j,m}\sigma^i\sigma^{i-1}) + \langle \alpha_0^{i-2}, \dots, \alpha_{i-3}^{i-2} \rangle (p'_{j,m}\alpha_{i-1}^i\sigma^i\sigma^{i-1}) = 0$, and thus $c^i\partial_M\partial_M = 0$.

In fact, we can distinguish three possible configurations:

- $\langle \alpha_0^i, \dots, \alpha_{i-2}^i \rangle (d) = \langle \alpha_0^i, \dots, \alpha_{i-2}^i \rangle (d\alpha_{i-1}^i)$, as for dart d in Fig. 14(a);
- $\langle \alpha_0^i, \dots, \alpha_{i-2}^i \rangle (d) \neq \langle \alpha_0^i, \dots, \alpha_{i-2}^i \rangle (d\alpha_{i-1}^i)$;
 - $\langle \alpha_0^{i-1}, \dots, \alpha_{i-2}^{i-1} \rangle (d\sigma^i) = \langle \alpha_0^{i-1}, \dots, \alpha_{i-2}^{i-1} \rangle (d\alpha_{i-1}^i\sigma^i)$, as for dart d in Fig. 15(a);
 - $\langle \alpha_0^{i-1}, \dots, \alpha_{i-2}^{i-1} \rangle (d\sigma^i) \neq \langle \alpha_0^{i-1}, \dots, \alpha_{i-2}^{i-1} \rangle (d\alpha_{i-1}^i\sigma^i)$ as for dart d in Fig. 16(a).

□

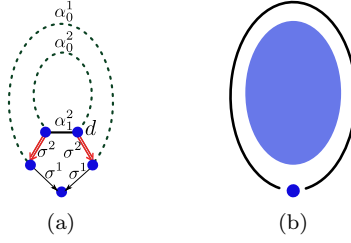

Figure 14: (a) A chain of maps encoding a $2d$ -disk, where dart d satisfies $\langle \alpha_0^2 \rangle (d) = \langle \alpha_0^2 \rangle (d\alpha_1^2)$. (b) The corresponding cellular subdivision.

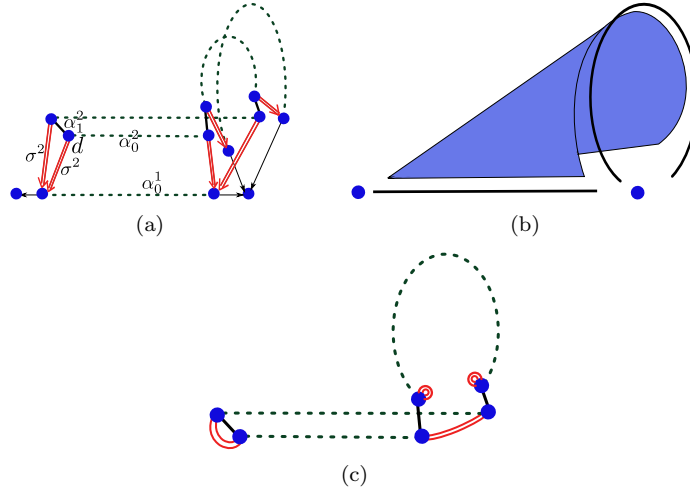

Figure 15: (a) A chain of maps where dart d satisfies $\langle \alpha_0^2 \rangle (d) \neq \langle \alpha_0^2 \rangle (d\alpha_1^2)$ and $\langle \alpha_0^1 \rangle (d\sigma^2) = \langle \alpha_0^1 \rangle (d\alpha_1^2\sigma^2)$. (b) The corresponding cellular subdivision. (c) The corresponding gmap.

4.3 Signed boundary operator

In order to define an homology with coefficients in \mathbb{Z} , it is necessary to define an orientation for any cell, and to take these orientations into account when defining the boundary operator. We restrict here to chains of maps such that:

- as before, all involutions are without fixed points;
- For all i , all i -cells are orientable, i.e. there are two orbits $\langle \alpha_0^i \alpha_1^i, \alpha_0^i \alpha_2^i, \dots, \alpha_0^i \alpha_{i-1}^i \rangle$ for any orbit $\langle \alpha_0^i, \dots, \alpha_{i-1}^i \rangle$ (cf. [Lie94] and Section 8).

The orientation condition corresponds to the fact that all darts of any cell can be partitioned into two distinct subsets, such that if dart d belongs to one

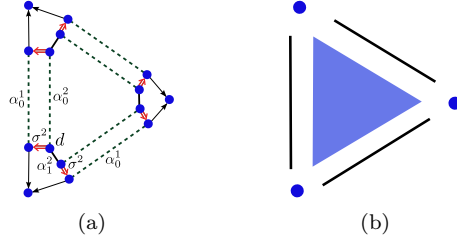

Figure 16: (a) A chain of maps where dart d satisfies $\langle \alpha_0^2 \rangle (d) \neq \langle \alpha_0^2 \rangle (d\alpha_1^2)$ and $\langle \alpha_0^1 \rangle (d\sigma^2) \neq \langle \alpha_0^1 \rangle (d\alpha_1^2\sigma^2)$. (b) The corresponding cellular subdivision.

of these subsets, all darts $d\alpha_j^i$ belong to the other subset. A possible way for representing this property consists in associating a sign (+ or -) with any dart d (denoted $sg(d)$), such that $sg(d) \neq sg(d\alpha_j^i) \forall j$. Let c^i be the i -cell incident to d : choosing an orientation for c^i consists in choosing a sign for d , the signs of the other darts of the cell are deduced from $sg(d)$.

Definition 4.5 (signed incidence number) Let C be a chain of maps, and let $i \in \{1, \dots, n\}$. Let $c^i(d^i)$ and $c^{i-1}(d^{i-1})$ be two cells of C . The signed incidence number, $(c^i(d^i) : c^{i-1}(d^{i-1}))$, is equal to $n_+ - n_-$, where:
 n_+ is the number of preimages (related to σ^i) of d^{i-1} in c^i whose sign is equal to $sg(d^{i-1})$,
 n_- is the number of preimages (related to σ^i) of d^{i-1} in c^i whose sign is different from $sg(d^{i-1})$.

The signed incidence number $(c^i : c^{i-1})$ is well defined, independently from the chosen darts: since c^i is orientable, any orbit $\langle \alpha_0^i, \dots, \alpha_{i-2}^i \rangle$ of c^i is orientable. Since σ^i restricted to an orbit $\langle \alpha_0^i, \dots, \alpha_{i-2}^i \rangle$ is an isomorphism, we can show that for any darts d and d' of this orbit, $sg(d).sg(d\sigma^i) = sg(d').sg(d'\sigma^i)$.

As for the unsigned boundary operator, we can provide an alternative definition: let $\{p_j\}_{j=1 \dots k}$ be darts of c^i such that $\{\langle \alpha_0^i, \dots, \alpha_{i-2}^i \rangle(p_j)\}_{j=1 \dots k}$ makes a partition of c^i . Then $(c^i : c^{i-1}) = \sum_{p_j, j=1 \dots k / p_j \sigma^i \in c^{i-1}} sg(p_j).sg(p_j \sigma^i)$ (where,

by abuse of notations, the signs are identified with +1 or -1). This alternative definition is equivalent to the original one, due to property 2a of definition 4.1. The corresponding boundary operator ∂_M acts on any i -cell c^i in the following way: $c^i \partial_M = \sum_{c^{i-1} \in G^{i-1}} (c^i : c^{i-1}) c^{i-1} = \sum_{p_j, j=1 \dots k} sg(p_j).sg(p_j \sigma^i) c^{i-1}(p_j \sigma^i)$. Operator ∂_M is extended on any sum of cells taken with any integer coefficients, by linearity.

Notice that such an operator ∂_M depends on the chosen cell orientations. We will see in Section 5 that the corresponding homology is equivalent to the simplicial homology of the semi-simplicial set associated with the chain of maps,

independently of the cell orientations. The cellular homology defined by a particular operator ∂_M is thus independent of the cell orientations which have been chosen for defining this operator.

Theorem 4.6 *Operator ∂_M is a boundary operator, i.e. $\partial_M \partial_M = 0$.*

Proof. The proof is similar to the unsigned case, but we have to take the orientations into account. Let $c^i = \langle \alpha_0^i, \dots, \alpha_{i-1}^i \rangle (d)$ be an i -cell, and let $\{p_j\}_{j=1 \dots k}$ be a set of darts such that the orbits $\{\langle \alpha_0^i, \dots, \alpha_{i-2}^i \rangle (p_j)\}_{j=1 \dots k}$ make a partition of c^i . $c^i \partial_M = \sum_{p_j, j=1 \dots k} sg(p_j) sg(p_j \sigma^i) c^{i-1}(p_j \sigma^i)$, where $c^{i-1}(p_j \sigma^i) =$

$\langle \alpha_0^{i-1}, \dots, \alpha_{i-2}^{i-1} \rangle (p_j \sigma^i)$. For each p_j , let $\{p_{j,m}\}_{m=1 \dots l_j}$ be a set of darts such that the orbits $\{\langle \alpha_0^{i-1}, \dots, \alpha_{i-3}^{i-1} \rangle (p_{j,m})\}_{m=1 \dots l_j}$ make a partition of $c^{i-1}(p_j \sigma^i)$. So $c^i \partial_M \partial_M = \sum_{p_j, j=1 \dots k} sg(p_j) sg(p_j \sigma^i) \partial_M c^{i-1}(p_j \sigma^i) =$

$$\sum_{p_j, j=1 \dots k} sg(p_j) sg(p_j \sigma^i) \sum_{p_{j,m}, m=1 \dots l_j} sg(p_{j,m}) sg(p_{j,m} \sigma^{i-1}) c^{i-2}(p_{j,m} \sigma^{i-1}),$$

where $c^{i-2}(p_{j,m} \sigma^{i-1}) = \langle \alpha_0^{i-2}, \dots, \alpha_{i-3}^{i-2} \rangle (p_{j,m} \sigma^{i-1})$. Since σ^i is a one-to-one mapping between orbits $\langle \alpha_0^i, \dots, \alpha_{i-2}^i \rangle (p_j)$ and $\langle \alpha_0^{i-1}, \dots, \alpha_{i-2}^{i-1} \rangle (p_j \sigma^i)$, let $\{p'_{j,m}\}_{m=1 \dots l_j}$ be the set of darts of $\langle \alpha_0^i, \dots, \alpha_{i-2}^i \rangle (p_j)$ such that $p'_{j,m} \sigma^i = p_{j,m}$. The orbits $\{\langle \alpha_0^i, \dots, \alpha_{i-3}^i \rangle (p'_{j,m})\}_{m=1 \dots l_j}$ make a partition of $\langle \alpha_0^i, \dots, \alpha_{i-2}^i \rangle (p_j)$ and thus

$$c^i \partial_M \partial_M = \sum_{j=1 \dots k} \sum_{m=1 \dots l_j} sign(p_j, p'_{j,m}) \langle \alpha_0^{i-2}, \dots, \alpha_{i-3}^{i-2} \rangle (p'_{j,m} \sigma^i \sigma^{i-1})$$

where

$$sign(p_j, p'_{j,m}) = sg(p_j) sg(p_j \sigma^i) sg(p'_{j,m}) sg(p'_{j,m} \sigma^i) sg(p'_{j,m} \sigma^i \sigma^{i-1})$$

Note that $sg(p_j) sg(p_j \sigma^i) sg(p'_{j,m}) sg(p'_{j,m} \sigma^i) = 1$, so $c^i \partial_M \partial_M = \sum_{j=1 \dots k} \sum_{m=1 \dots l_j} sg(p'_{j,m}) sg(p'_{j,m} \sigma^i \sigma^{i-1}) \langle \alpha_0^{i-2}, \dots, \alpha_{i-3}^{i-2} \rangle (p'_{j,m} \sigma^i \sigma^{i-1})$

The set of orbits $\{\langle \alpha_0^i, \dots, \alpha_{i-3}^i \rangle (p'_{j,m})\}_{j=1 \dots k, m=1 \dots l_j}$ make a partition of c^i . Since for all j, m , $\langle \alpha_0^i, \dots, \alpha_{i-3}^i \rangle (p'_{j,m}) \neq \langle \alpha_0^i, \dots, \alpha_{i-3}^i \rangle (p'_{j,m} \alpha_{i-1}^i)$ (cf. lemma 4.4), and $p'_{j,m} \sigma^i \sigma^{i-1} = p'_{j,m} \alpha_{i-1}^i \sigma^i \sigma^{i-1}$ (cf. property 2b of definition 4.1), and $sg(p'_{j,m}) \neq sg(p'_{j,m} \alpha_{i-1}^i)$ (the gmap is orientable), $sg(p'_{j,m}) sg(p'_{j,m} \sigma^i \sigma^{i-1}) \langle \alpha_0^{i-2}, \dots, \alpha_{i-3}^{i-2} \rangle (p'_{j,m} \sigma^i \sigma^{i-1}) + sg(p'_{j,m} \alpha_{i-1}^i) sg(p'_{j,m} \alpha_{i-1}^i \sigma^i \sigma^{i-1}) \langle \alpha_0^{i-2}, \dots, \alpha_{i-3}^{i-2} \rangle (p'_{j,m} \alpha_{i-1}^i \sigma^i \sigma^{i-1}) = 0$, and thus $c^i \partial_M \partial_M = 0$. □

4.4 Algorithms

We present now Algorithm 2 which computes the signed incidence number ($c^i : c^{i-1}$). Remember that cells in chain of maps are linked together by the σ^i operator defined between $D^i \rightarrow D^{i-1}$. When only σ^i operators are represented in data structures, it is simpler in algorithms to run through darts in c^i and to count the number of times a dart belonging to c^{i-1} is found than to run through darts in c^{i-1} and finding its number of antecedents.

For this reason, we use in our algorithm the second version of the signed incidence number definition: let $\{d_j^i\}_{j=1\dots k}$ be darts of c^i such that $\{\langle \alpha_0^i, \dots, \alpha_{i-2}^i \rangle (d_j^i)\}_{j=1\dots k}$ makes a partition of c^i . Then $(c^i : c^{i-1}) = \sum_{d_j^i, j=1\dots k / d_j^i \in c^{i-1}} sg(d_j^i).sg(d_j^i \sigma^i)$.

Algorithm 2: Compute the signed incidence number ($c^i(d) : c^{i-1}(d')$) for a chain of maps.

Data: $CM = (G^i)_{i=0,\dots,n}, (\sigma^i)_{i=1,\dots,n}$: a signed n D chain of maps
 i : a dimension, $1 \leq i \leq n$
 d, d' : two darts of CM such that $d \in G^i$ and $d' \in G^{i-1}$

Result: The signed incidence number ($c^i(d) : c^{i-1}(d')$)

```

1  $res \leftarrow 0$ ;
2 foreach  $c \in c^i(d)$  do
3   if  $c$  is not marked treated and  $c\sigma^i \in c^{i-1}(d')$  then
4      $res \leftarrow res + sg(c).sg(c\sigma^i)$ ;
5     mark treated all the darts of  $\langle \alpha_0^i, \dots, \alpha_{i-2}^i \rangle(c)$ ;
6 return  $res$ ;

```

To compute this sum, Algorithm 2 runs through all the darts of $c^i(d)$, and test if dart c is marked. If this is the case, dart c belongs to an orbit $\langle \alpha_0^i, \dots, \alpha_{i-2}^i \rangle$ already taken into account.

Otherwise, the partition is not already treated, thus we test if $c\sigma^i \in c^{i-1}(d')$. If it is not the case, the incidence number is not modified. Otherwise, we add one or subtract one depending on if $sg(c)$ is equal to $sg(c\sigma^i)$ or not. Then we mark treated all the darts belonging to $\langle \alpha_0^i, \dots, \alpha_{i-2}^i \rangle(c)$ since all these darts must not be re-consider later.

At the end of this algorithm, we have considered all the darts belonging to $c^i(d)$, and thus we have computed the sum $\sum_{d_j^i, j=1\dots k / d_j^i \in c^{i-1}} sg(d_j^i).sg(d_j^i \sigma^i)$.

This is the signed incident number.

The complexity of this algorithm is linear in number of darts in $c^i(d)$. Indeed, each dart of $c^i(d)$ is considered exactly once in the *for loop*, and in this loop, we process only non marked darts. That ensure that each dart of $c^i(d)$ is marked only once. Note that the test if $c\sigma^i \in c^{i-1}(d')$ can be achieved in $O(1)$ by marking before the loop all the darts of $c^{i-1}(d')$. During the loop, it is enough

to test if $c\sigma^i$ is marked.

This algorithm takes as input a signed chain of maps, i.e. each dart is marked with a (+ or -) with any dart d (denoted $sg(d)$), such that $sg(d) \neq sg(d\alpha_j^i) \forall j$. Note that the same algorithm can be used to compute the unsigned incidence number. The only difference being that the considered chain of maps is no more signed since we do not use $sg(d_j^i)$ and $sg(d_j^i\sigma^i)$. Moreover, *res* is now a Boolean initialized to false, and negated at each time the condition *c is not marked treated* **and** $c\sigma^i \in c^{i-1}(d')$ is satisfied since in $\mathbb{Z}/2\mathbb{Z}$, $1 + 1 = 1 - 1 = 0$.

Now to compute the i^{th} incidence matrix, we can use Algorithm 2 for each pair of i -cells and $(i - 1)$ -cells. However, it is possible to improve this basic version by avoiding the test if $c\sigma^i \in c^{i-1}(d')$. This is given in Algorithm 3 which compute the i^{th} incidence matrix, i.e. incidence numbers between all i -cells and $(i - 1)$ -cells.

Algorithm 3: Computation of the i^{th} incidence matrix

Data: $CM = (G^i)_{i=0,\dots,n}, (\sigma^i)_{i=1,\dots,n}$: a signed n D chain of maps
i: a dimension, $0 \leq i \leq n$
 C^i (resp. C^{i-1}) is the set of i -cells (resp. $(i - 1)$ -cells)

Result: The incidence matrix E^i

```

1 if  $i=0$  then
2   |  $E^i \leftarrow \text{zeroMatrix}(\text{card}(C^0), 1)$ ;
3 else
4   |  $E^i \leftarrow \text{zeroMatrix}(\text{card}(C^i), \text{card}(C^{i-1}))$ ;
5   | foreach dart  $d \in G^i$  do
6     |   if  $d$  is not marked treated then
7       |     foreach dart  $d' \in c^i(d)$  do
8         |       if  $d'$  is not marked treated then
9           |          $E^i(c^i(d), c^{i-1}(d'\sigma^i)) \leftarrow$ 
10            |          $E^i(c^i(d), c^{i-1}(d'\sigma^i)) + sg(d') \cdot sg(d'\sigma^i)$ ;
11            |         mark treated all the darts of  $\langle \alpha_0^i, \dots, \alpha_{i-2}^i \rangle (d')$ ;
12   |   return  $E^i$ ;

```

The case $i = 0$ is specific since there is no (-1) -cell thus the 0-incidence matrix is a zero matrix having $\text{card}(C^0)$ columns, which is the number of 0-cells and one line.

Otherwise, the incidence matrix E^i is initialized to a zero matrix having $\text{card}(C^i)$ columns and $\text{card}(C^{i-1})$ lines. Then we run through all the darts $d \in G^i$. If d is not marked, its i -cell $c^i(d)$ is not yet processed. Thus we enter in the second loop to compute all the incidence numbers between all the $(i - 1)$ -cells and $c^i(d)$. For that we only run through all the darts of $d' \in c^i(d)$ and consider each $(i - 1)$ -cell $c^{i-1}(d'\sigma^i)$. Indeed, other $(i - 1)$ -cells do not belong to the boundary of $c^i(d)$ thus we know that the incidence number between these cells and $c^i(d)$ is zero.

For each $(i-1)$ -cell, we use the same principle than for Algorithm 2, adding or subtracting one depending if d' and $d'\sigma^i$ have the same sign or not. After having considered all the darts $d' \in c^i(d)$, we have treated all the $(i-1)$ -cells incident to $c^i(d)$ thus we have computed all the incidence numbers between $c^i(d)$ and all the $(i-1)$ -cells. At the end of Algorithm 3 we have treated all the i -cells of the chain of maps, and for each one computed the incidence number with all the $(i-1)$ -cells in its boundary. Thus the matrix E^i is the i^{th} incidence matrix.

The complexity of Algorithm 3 is linear in number of darts of G^i . Indeed, each dart is considered exactly once during the second loop thanks to the treated mark, and for each dart, we have a direct access to each value used to compute the incidence number ($d'\sigma^i$, $sg(d')$ and $sg(d'\sigma^i)$).

To compute all the incidence matrices for a given n D chain of maps, we need first to orient each cell of the chain of maps; second to run Algorithm 3 for each i , $0 \leq i \leq n$. The complexity of the overall process is thus linear in the sum of all the $|G^i|$, $1 \leq i \leq n$, i.e. linear in size of the chain of maps.

5 Conditions and proof of the equivalence between cellular and simplicial homology on chains of maps

5.1 Simplicial interpretation of a chain of maps

A numbered semi-simplicial set can be associated with a chain of maps C in the following way (cf. Fig. 13). Let c^i be an i -cell of C , d be a dart of c^i , and $I = [0, i]$:

- *Simplices.* For $0 \leq j \leq i$, we associate a j -dimensional simplex numbered $\{k_0, \dots, k_{j-1}, i\}$ with the orbit $\langle \rangle_{I-\{k_0, \dots, k_{j-1}, i\}}(d)$, denoted $T(\langle \rangle_{I-\{k_0, \dots, k_{j-1}, i\}}(d))$;
- *Face operators* $(d_l)_{l \in [0, \dots, j]}$, if $j \geq 1$:
 - for any $l, 0 \leq l \leq j-1$, $T(\langle \rangle_{I-\{k_0, \dots, k_l, \dots, k_{j-1}, i\}}(d))d_l = T(\langle \rangle_{I-\{k_0, \dots, \hat{k}_l, \dots, k_{j-1}, i\}}(d))$;
 - $T(\langle \rangle_{I-\{k_0, \dots, k_{j-1}, i\}}(d))d_j = T(\langle \rangle_{K_{j-1}-\{k_0, \dots, k_{j-1}\}}(d\sigma^i \dots \sigma^{k_{j-1}+1}))$, where $K_{j-1} = [0, \dots, k_{j-1}]$.

As for generalized maps (cf. 2.3 and [Lie94]), we can prove that T extended on all orbits of an n -dimensional chain of maps C associates a semi-simplicial set $T(C)$ with it. $T(C)$ is a numbered one, i.e. it is structured into cells: any i -dimensional cell is identified by a vertex σ numbered by i , and made by all simplices of the star of σ which are numbered by integers lower than or equal to i .

We now study the equivalence between the cellular homology as defined by a boundary operator acting on a chain of maps, and the simplicial homology

defined on the associated semi-simplicial set. We show that it is possible to associate a homologous simplicial cycle (resp. boundary) with any cellular cycle (resp. boundary) (cf. Sections 5.2 and 5.3) and conversely (cf. Section 5.4).

5.2 Associating a simplicial chain with a cellular chain: unsigned case

A chain of simplices can be associated with any cell in the following way (cf. Fig. 13):

Definition 5.1 Let c^i be an i -cell. We define $c^i\tau = \sum_{d \in c^i} T(\langle \rangle(d))$.

This definition can be extended on any sum of cells by linearity, where the coefficients are in $\mathbb{Z}/2\mathbb{Z}$: such a sum is an *unsigned chain of cells*.

Theorem 5.2 Any chain of cells v of dimension greater than or equal to 1 satisfies $v\tau\partial_S = v\partial_M\tau$ (where ∂_S and ∂_M are respectively the simplicial and cellular boundary operators with coefficients in $\mathbb{Z}/2\mathbb{Z}$).

Proof. We prove that any i -dimensional cell c^i , with $1 \leq i$, satisfies $c^i\tau\partial_S = c^i\partial_M\tau$, and the theorem is deduced by linearity.

$$\begin{aligned} \text{We have } c^i\tau\partial_S &= \left(\sum_{d \in c^i} T(\langle \rangle(d)) \right) \partial_S = \sum_{d \in c^i} T(\langle \rangle(d)) \partial_S = \sum_{d \in c^i} \sum_{j=0 \dots i} T(\langle \rangle(d)) d_j \\ &= \left(\sum_{d \in c^i} \sum_{j=0 \dots i-1} T(\langle \rangle(d)) d_j \right) + \left(\sum_{d \in c^i} T(\langle \rangle(d)) d_i \right) = \left(\sum_{j=0 \dots i-1} \sum_{d \in c^i} T(\langle \rangle(d)) d_j \right) \\ &+ \sum_{d \in c^i} T(\langle \rangle(d)) d_i. \end{aligned}$$

When $0 \leq j \leq i-1$, $T(\langle \rangle(d)) d_j = T(\langle \alpha_j^i \rangle(d))$. Since α_j^i is an involution without fixed points, $T(\langle \alpha_j^i \rangle(d))$ appears twice in the sum, once for d and once for $d\alpha_j^i$. So, $c^i\tau\partial_S = \sum_{d \in c^i} T(\langle \rangle(d)) d_i = \sum_{d \in c^i} T(\langle \rangle(d\sigma^i))$.

We have $c^i\partial_M\tau = \left(\sum_{p_j, j=0 \dots k} c^{i-1}(p_j\sigma^i) \right) \tau$, where $\{\langle \alpha_0^i, \dots, \alpha_{i-2}^i \rangle(p_j)\}_{j=0 \dots k}$ makes a partition of c^i . So, $c^i\partial_M\tau = \sum_{p_j, j=0 \dots k} c^{i-1}(p_j\sigma^i) \tau = \sum_{p_j, j=0 \dots k} \sum_{d' \in c^{i-1}(p_j\sigma^i)} T(\langle \rangle(d'))$. Since σ^i restricted to an orbit $\langle \alpha_0^i, \dots, \alpha_{i-2}^i \rangle$ is an isomorphism, we have $c^i\partial_M\tau = \sum_{p_j, j=0 \dots k} \sum_{d' \in \langle \alpha_0^i, \dots, \alpha_{i-2}^i \rangle(p_j)} T(\langle \rangle(d'\sigma^i)) = \sum_{d' \in c^i} T(\langle \rangle(d'\sigma^i)) = c^i\tau\partial_S$. □

Corollary 5.3 τ associates a simplicial cycle (resp. boundary) with any cellular cycle (resp. boundary).

Proof. Let v be a cellular cycle, i.e. $v\partial_M = 0$. So $v\partial_M\tau = 0 = v\tau\partial_S$, and $v\tau$ is a simplicial cycle.

Let v, c^{i+1} be such that $v = c^{i+1}\partial_M$. Then $v\tau = c^{i+1}\partial_M\tau = c^{i+1}\tau\partial_S$, and $v\tau$ is a simplicial boundary. \square

5.3 Associating a simplicial chain with a cellular chain: signed case

Definition 5.4 Let c^i be an i -dimensional oriented cell. We define $c^i\tau = \sum_{d \in c^i} sg(d)T(\langle \rangle(d))$.

This definition can be extended on any sum of cells with integer coefficients, by linearity: such a sum is a *signed chain of cells*.

Theorem 5.5 Let $i \geq 1$, and v be an i -dimensional signed chain of cells. $v\tau\partial_S = (-1)^i v\partial_M\tau$ (where ∂_S and ∂_M are respectively the simplicial and cellular boundary operators with coefficients in \mathbb{Z}).

Proof. We prove that any i -dimensional cell c^i , with $1 \leq i$, satisfies $c^i\tau\partial_S = (-1)^i c^i\partial_M\tau$, and the theorem is deduced by linearity.

We have $c^i\tau\partial_S = (\sum_{d \in c^i} sg(d)T(\langle \rangle(d)))\partial_S = \sum_{d \in c^i} sg(d)T(\langle \rangle(d))\partial_S = \sum_{d \in c^i} sg(d) \sum_{j=0 \dots i} (-1)^j T(\langle \rangle(d))d_j = \sum_{d \in c^i} sg(d) \sum_{j=0 \dots i-1} (-1)^j T(\langle \rangle(d))d_j + \sum_{d \in c^i} sg(d)(-1)^i T(\langle \rangle(d))d_i = \sum_{j=0 \dots i-1} (-1)^j \sum_{d \in c^i} sg(d)T(\langle \alpha_j^i \rangle(d)) + (-1)^i \sum_{d \in c^i} sg(d)T(\langle \rangle(d\sigma^i))$. Since α_j^i is an involution without fixed points, and the cells are orientable, $T(\langle \alpha_j^i \rangle(d))$ appears for d and for $d\alpha_j^i$ with opposite signs. So $c^i\tau\partial_S = (-1)^i \sum_{d \in c^i} sg(d)T(\langle \rangle(d\sigma^i))$.

On the other hand, we have :

$$c^i\partial_M\tau = \sum_{p_j, j=0 \dots k} sg(p_j).sg(p_j\sigma^i)(c^{i-1}(p_j\sigma^i))\tau,$$

where $\{\langle \alpha_0^i, \dots, \alpha_{i-2}^i \rangle(p_j)\}_{j=0 \dots k}$ makes a partition of c^i . So $c^i\partial_M\tau = \sum_{p_j, j=0 \dots k} sg(p_j).sg(p_j\sigma^i) \sum_{d' \in c^{i-1}(p_j\sigma^i)} sg(d')T(\langle \rangle(d'))$. Since σ^i restricted to

orbits $\langle \alpha_0^i, \dots, \alpha_{i-2}^i \rangle$ is an isomorphism,

$$\begin{aligned}
& c^i \partial_M \tau \\
= & \sum_{p_j, j=0 \dots k} sg(p_j) \cdot sg(p_j \sigma^i) \sum_{d' \in \langle \alpha_0^i, \dots, \alpha_{i-2}^i \rangle(p_j)} sg(d' \sigma^i) T(\langle \rangle(d' \sigma^i)) \\
= & \sum_{p_j, j=0 \dots k} sg(p_j) \cdot sg(p_j \sigma^i) \left(\sum_{d' \in \langle \alpha_0^i \alpha_1^i, \dots, \alpha_0^i \alpha_{i-2}^i \rangle(p_j)} sg(p_j \sigma^i) T(\langle \rangle(d' \sigma^i)) \right) \\
& - \sum_{d' \in \langle \alpha_0^i \alpha_1^i, \dots, \alpha_0^i \alpha_{i-2}^i \rangle(p_j \alpha_0^i)} sg(p_j \sigma^i) T(\langle \rangle(d' \sigma^i)) \\
= & \sum_{p_j, j=0 \dots k} sg(p_j) \left(\sum_{d' \in \langle \alpha_0^i \alpha_1^i, \dots, \alpha_0^i \alpha_{i-2}^i \rangle(p_j)} T(\langle \rangle(d' \sigma^i)) \right) \\
& - \sum_{d' \in \langle \alpha_0^i \alpha_1^i, \dots, \alpha_0^i \alpha_{i-2}^i \rangle(p_j \alpha_0^i)} T(\langle \rangle(d' \sigma^i)) \\
= & \sum_{p_j, j=0 \dots k} \sum_{d' \in \langle \alpha_0^i, \dots, \alpha_{i-2}^i \rangle(p_j)} sg(d') T(\langle \rangle(d' \sigma^i)) \\
= & \sum_{d' \in c^i} sg(d') T(\langle \rangle(d' \sigma^i)) \\
= & (-1)^i c^i \tau \partial_S
\end{aligned}$$

□

Corollary 5.6 τ associates a simplicial cycle (resp. boundary) with any cellular cycle (resp. boundary).

Proof. Let v be a signed chain of cells such that $v \partial_M = 0$. Then $v \partial_M \tau = 0 = (-1)^i v \tau \partial_S$, so $v \tau$ is a simplicial cycle.

Let v, c^{i+1} be such that $v = c^{i+1} \partial_M$. Then $v \tau = c^{i+1} \partial_M \tau = (-1)^{i+1} c^{i+1} \tau \partial_S$, and $v \tau$ is a simplicial boundary. □

5.4 An homologous cellular cycle (resp. boundary) is associated with any simplicial cycle (resp. boundary)

We now show that a homologous cellular cycle (resp. boundary) can be associated with any simplicial cycle (resp. boundary). We do not distinguish between the signed and the unsigned cases, since the proofs are quite similar. In order to show this correspondence, we use the fact that any chain of maps can be constructed in the following way (see Fig. 13):

- create any main¹⁴ i -dimensional cell and its boundary. We restrict here this operation to the creation of cells which boundaries have the homology of a $(i - 1)$ -dimensional sphere;
- identify j -dimensional cells ($0 \leq j \leq i - 1$) which share a same boundary (we assume that the boundary of a vertex is null).

These two operations are formally defined below.

We then show that, with the following hypotheses:

- all involutions are without fixed points;
- $\forall i \geq 1, \sigma^i$ restricted to an orbit $\langle \alpha_0^i, \dots, \alpha_{i-2}^i \rangle$ is an isomorphism between this orbit and an $(i - 1)$ -dimensional cell;
- for the homology with coefficients in \mathbb{Z} , all cells are orientable;
- for each cell $c^i = (D^{c^i}, \alpha_0^i, \dots, \alpha_{i-1}^i, \omega)$, the chain of maps corresponding to its *canonical boundary* $(D^{c^i}, \alpha_0^i, \dots, \alpha_{i-1}^i)$ has the homology of a $(i - 1)$ -dimensional sphere.

then:

Theorem 5.7 *Let z_s be a simplicial cycle (resp. boundary), i.e. a cycle in the semi-simplicial set associated with a chain of maps. Then a cellular cycle (resp. boundary) z_c exists in the chain of maps, such that $z_c \tau$ is homologous to z_s .*

using the following lemma illustrated in Fig. 17:

Lemma 5.8 *Let c_s be a simplicial chain, such that:*

- all simplices of c_s belong to $T(\text{cel})$, where cel is a cell which dimension is strictly greater than that of c_s ;
- the simplices of the boundary of c_s belong to the semi-simplicial subset associated with the boundary of cel .

Then a simplicial chain c'_s exists, which is homologous to c_s (and thus which has the same boundary as c_s), such that all simplices of c'_s are in the semi-simplicial subset associated with the boundary of cel .

Proof. We first prove the theorem, assuming the lemma is true.

¹⁴A main cell has an empty star.

Correspondence of cycles.

Let z_s be a k -dimensional simplicial cycle (i.e. $z_s \partial_S = 0$, where ∂_S denotes the simplicial boundary operator with coefficients in $\mathbb{Z}/2\mathbb{Z}$ or in \mathbb{Z}). We can define a partition of the simplices of z_s according to the cells which triangulations produce these simplices, i.e. $z_s = \sum_{c_i} \sum_j \nu_{i_j} s_{i_j}$, where s_{i_j} is a simplex of $T(c_i)$ and ν_{i_j} is its coefficient (in $\mathbb{Z}/2\mathbb{Z}$ or in \mathbb{Z}).

- Assume that $\forall i$, the dimension of c_i is equal to the dimension of z_s . Then $\forall i$, $\sum_j \nu_{i_j} s_{i_j} = \nu_i c_i \tau$. If it is not the case, it is easy to prove that the boundary of this "subchain" contains simplices of $T(c_i)$, which cannot be removed by the boundary of an other "subchain", involving that the boundary of z_s is not null: contradiction.
- Assume that cells exist which dimension is strictly greater than that of z_s . Let c_i be such a cell, such that its dimension is maximal. The simplices of $(\sum_j \nu_{i_j} s_{i_j}) \partial_S$ are in the semi-simplicial set associated to the boundary of c_i : otherwise, and due to the definition of face operators of the semi-simplicial set associated with a chain of map, the boundary of this "subchain" contains simplices of $T(c_i)$, which cannot be removed by the boundary of an other "subchain": as before, we get a contradiction. Using the lemma, a chain z_i exists, such that its simplices are in the semi-simplicial set associated with the boundary of c_i , and which is homologous to $\sum_j \nu_{i_j} s_{i_j}$. We can thus replace this subchain by z_i in z_s . By iterating the process, we can replace z_s by an homologous cycle which satisfies the conditions of the first case.

Correspondence of boundaries.

Let b_s be a simplicial boundary: since a boundary is a cycle, a cellular cycle z_c exists, such that $z_c \tau$ is homologous to b_s ; $z_c \tau$ is thus a simplicial boundary, i.e. a simplicial chain c_k exists, such that $z_c \tau = c_k \partial_S$. As before, we can define a partition of the simplices of c_k according to the cells which triangulations produce these simplices, i.e. $c_k = \sum_{c_i} \sum_j \nu_{i_j} s_{i_j}$, where s_{i_j} is a simplex of $T(c_i)$. We prove that c_k is homologous to the image by τ of a cellular chain as before, i.e. by distinguishing the cases:

- assume that $\forall i$, the dimension of c_i is equal to the dimension of c_k . Then $\forall i$, $\sum_j \nu_{i_j} s_{i_j} = \nu_i c_i \tau$. If it is not the case, this leads to a contradiction, since the boundary of c_k is associated by τ with a cellular chain;

- assume that cells exists which dimension is strictly greater than that of c_k . Let c_i be such a cell, such that its dimension is maximal. Using the lemma, a chain z_i exists, such that its simplices are in the semi-simplicial set associated with the boundary of c_i , and which is homologous to $\sum_j \nu_{i_j} s_{i_j}$. We can thus replace this subchain by z_i in c_k . By iterating the process, we can replace c_k by an homologous chain which satisfies the conditions of the first case.

□

Proof. We now prove lemma 5.8. As said before, any chain of maps can be constructed by creating its main cells and their boundaries, and by identifying cells of the boundaries of main cells. We will show for each operation that if the lemma is satisfied before applying the operation, it is still satisfied after.

Creating an i -cell and its boundary.

A connected n -dimensional generalized map $G = (D, \alpha_0, \dots, \alpha_n)$ such that $\alpha_n = \text{identity}$ defines an n -cell and its boundary, and it is possible to associate an equivalent chain of maps with it. More generally, given a gmap $G = (D, \alpha_0, \dots, \alpha_n)$, we can associate with it a chain of maps $C = ((G^i = (D^i, \alpha_0^i, \dots, \alpha_{i-1}^i, \omega))_{i=0 \dots n}, (\sigma^i)_{i=1 \dots n})$, such that the corresponding quasi-manifolds are isomorphic [EL94]). There is a one-to-one mapping B between the orbits $\langle \alpha_{i+1}, \dots, \alpha_n \rangle$ of G and the darts of D^i . Moreover, $\forall d \in D$:

- $B(\langle \alpha_{i+1}, \dots, \alpha_n \rangle (d)) \alpha_j^i = B(\langle \alpha_{i+1}, \dots, \alpha_n \rangle (d \alpha_j))$, $\forall 0 \leq j \leq i-1 < n$;
- $B(\langle \alpha_{i+1}, \dots, \alpha_n \rangle (d)) \sigma^i = B(\langle \alpha_i, \alpha_{i+1}, \dots, \alpha_n \rangle (d))$, $\forall 1 \leq i \leq n$.

Creating an i -dimensional cell and its boundary consists in creating a cell c^i defined by $(D, \alpha_0, \dots, \alpha_{i-1}, \omega)$, a chain of maps corresponding to its canonical boundary $(D, \alpha_0, \dots, \alpha_{i-1})$, and σ^i is defined by: $\forall d \in D, b\sigma^i = B(\langle \rangle (d))$. The resulting chain of maps corresponds to the gmap $(D, \alpha_0, \dots, \alpha_{i-1}, \alpha_i = \text{identity})$, and it is shown in [Lie94] that the corresponding semi-simplicial set is a cone. Its simplicial homology is thus trivial (i.e. $H_0 = \mathbb{Z}, H_j = 0, \forall j \geq 1$). Moreover, as said before, we restrict here the construction to gmaps such that the chain of maps associated to $(D, \alpha_0, \dots, \alpha_{i-1})$ has the cellular homology of a sphere (i.e. $H_0 = \mathbb{Z}, H_j = 0, 1 \leq j \leq i-2, H_{i-1} = \mathbb{Z}$). By the recursion hypothesis, the simplicial homology of the associated semi-simplicial set is also that of a sphere. c^i is the unique i -dimensional cell, and the cells of $c^i \partial_M$ (where ∂_M is the cellular boundary operator defined on chains of maps,

with coefficients in $\mathbb{Z}/2\mathbb{Z}$ or in \mathbb{Z}) are $(i - 1)$ -dimensional cells. Since a boundary is a cycle, $c^i \partial_M$ is an element of the unique class of the $(i - 1)$ -dimensional cycles, and it is now a boundary. The cellular homology of c^i and its boundary is thus the homology of a cone, equal to the simplicial homology of the corresponding semi-simplicial set.

Let z_s be a k -dimensional simplicial chain, such that $1 \leq k \leq i - 1$, the simplices of z_s are simplices of $T(c^i)$, and the simplices of $z_s \partial_S$ are simplices of the semi-simplicial set associated with the boundary of c^i . $z_s \partial_S$ is thus a cycle made with simplices contained in the semi-simplicial set associated with the boundary of c^i . Since the simplicial homology of the boundary of c^i is the homology of a sphere, any $(k - 1)$ -cycle is a boundary, and a k -dimensional chain z'_s exists, which simplices are contained in the semi-simplicial set associated with the boundary of c^i , and such that $z'_s \partial_S = z_s \partial_S$. Thus $z_s - z'_s$ is a cycle, and since any k -dimensional cycle is a k -dimensional boundary (the homology of the chain of maps is the homology of a cone), a simplicial chain c' exists, which simplices are contained in $T(c^i)$ and in the semi-simplicial set associated with its boundary, such that $z'_s = z_s + c' \partial_S$. So, if the lemma is satisfied before creating a cell and its boundary, it is still satisfied after.

Identifying two cells.

The identification of two cells corresponds to the following operation: let c^i and c'^i be two distinct isomorphic i -dimensional cells (having the same boundary if $i \geq 1$), i.e. an isomorphism ϕ exists, such that $\forall d \in c^i, \forall j, 0 \leq j \leq i - 1, d \alpha_j^i \phi = d \phi \alpha_j^i$, and $d \sigma^i = d \phi \sigma^i$. The chain of maps is then modified by dividing it by ϕ , i.e. by identifying d with $d \phi$ for all darts d of c^i . Let us denote \bar{c}^i the cell resulting from the identification of c^i and c'^i . Due to the definition of the identification operation, a morphism exists between the initial chain of maps and the chain of maps resulting from the identification operation: this morphism can be extended onto a morphism between the associated semi-simplicial sets, and finally onto a morphism Φ between the associated simplicial chain complexes. By definition of a morphism, we have the following property: let c be a simplicial chain, the simplices of which belong to the initial chain of maps, then $c \partial_S \Phi = c \Phi \partial_S$.

Assume that lemma 5.8 is satisfied before an identification operation. After operation, let c' be a simplicial chain which simplices are contained in $T(cel)$, where cel is a cell of the chain of maps, and such that the simplices of $c' \partial_S$ are contained in the semi-simplicial set associated with the boundary of cel . We are now going to show that lemma 5.8 is still satisfied. For this we are considering the following three possible cases of identification.

case 1: $\bar{c}^i = cel$. The chain c' corresponds thus to a chain c'_1 and to a chain c'_2 , such that the simplices of c'_1 (resp. c'_2) are contained in $T(c^i)$ (resp. $T(c'^i)$), and they are isomorphic to each other (by ϕ extended to

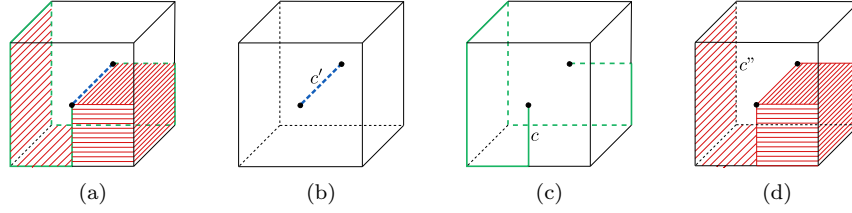

Figure 17: (b) A 1d-chain c' having all its simplices in a 3d-cell, such that the simplices of its boundary are in the boundary of the 3d-cell. (c) A 1d-chain c homologous to c' having all its simplices in the boundary of the 3d-cell. (d) 2d-chain c'' such that $c' = c + c''\partial_S$. (a) c' , c and c'' on the same figure.

$T(c^i)$ and to the associated chains of simplices). Since $c'_1\partial_S = c'_2\partial_S$, and the corresponding simplices are contained in $T(c^i)\partial_S = T(c'^i)\partial_S$, by the recursion hypothesis, a chain c_1 exists, which simplices are contained in $T(c^i)\partial_S$, a chain c''_1 exists, which simplices are contained in $T(c^i)$ and in $T(c^i)\partial_S$, such that $c'_1 = c_1 + c''_1\partial_S$, and $c'_2 = c_1 + c''_1\Phi\partial_S$. The identification operation results in identifying c'_1 with c'_2 into c' , c''_1 with $c''_1\Phi$ into c'' , and we get: $c' = c_1 + c''\partial_S$, where the simplices of c_1 are contained in $T(cel)\partial_S$, and the simplices of c'' are contained in $T(cel)$ and in $T(cel)\partial_S$.

case 2: \bar{c}^i is in the boundary of cel . First, we show that c' satisfied the lemma conditions before identification. We know that cel was not affected by the identification, so before identification, c' was a simplicial chain the simplices of which are contained in $T(cel)$. Moreover, the fact that Φ is a morphism ensures that the simplices of $c'\partial_S$ were in $T(cel)\partial_S$. So, before identification, c' satisfied the lemma conditions, and $c' = c + c''\partial_S$, where the simplices of c (resp. c'') belong to $T(cel)\partial_S$ (resp. to $T(cel)\cup T(cel)\partial_S$). More precisely, the chain c' can be decomposed as follow:

$$c' = (c_1 + c_2 + c_3) + (c''_1 + c''_2 + c''_3 + c''_4)\partial_S$$

where:

- the simplices of c_1 (resp. c_2, c_3) belong to $T(cel)\partial_S - T(c^i) - T(c'^i)$ (resp. $T(c^i), T(c'^i)$);
- the simplices of c''_1 (resp. c''_2, c''_3, c''_4) belong to $T(cel)$ (resp. $T(c^i), T(c'^i), T(cel)\partial_S - T(c^i) - T(c'^i)$).

After identification, we get:

$$\begin{aligned} c' = c'\Phi &= (c_1 + c_2 + c_3)\Phi + (c''_1 + c''_2 + c''_3 + c''_4)\partial_S\Phi \\ &= (c_1 + c_2 + c_3)\Phi + (c''_1 + c''_2 + c''_3 + c''_4)\Phi\partial_S \\ &= c_1 + c_2\Phi + c_3\Phi + c''_1\partial_S + c''_2\Phi\partial_S + c''_3\Phi\partial_S + c''_4\partial_S \end{aligned}$$

As Φ is a morphism, the simplices of $c_i\Phi$ belong to the boundary of $T(\text{cel})$, for $i = 1..3$; the simplices of c''_1 belong to $T(\text{cel})$ and the simplices of $c''_j\Phi$ belong to the boundary of $T(\text{cel})$, for $j = 2..4$, and the lemma is satisfied.

case 3: $\bar{c}^i \neq \text{cel}$ and $\bar{c}^i \notin \text{cel}\partial_M$. c' is not affected by the identification, and the lemma remains true for c' . \square

Corollary 5.9 *A consequence of corollaries 5.3 and 5.6 and theorem 5.7 is the existence of a one-to-one mapping between the classes of cellular cycles (resp. boundaries) of a chain of maps and the classes of simplicial cycles (resp. boundaries) of the associated semi-simplicial set. The cellular homology is thus equivalent to the simplicial homology.*

6 Conditions and proof of the equivalence between cellular and simplicial homology on incidence graphs

We first prove that chains of surfaces are equivalent to a subclass of chains of maps, more precisely chains of maps representing subdivisions without multi-incidence whose main cells have closed connected boundaries. We then show that the simplicial interpretation of both structures are equivalent. We finally prove that both boundary operators (unsigned and signed) built on both structures also are equivalent and define hence the same homology.

6.1 Equivalence between closed chains of maps without multi-incidence and chains of surfaces

Chains of maps are able to encode subdivisions containing multi-incidence whereas incidence graphs cannot. A cell is multiply incident to another when it is present several times among its faces, like a vertex being incident twice to an edge hence creating a simple loop (see Fig. 6(c)). To avoid such configurations we have hence to add some more constraints on the way cells are glued together, which first implies to be more restrictive on the definition of σ operators. But as pointed out before (see Section 4.1 page 28), the structure of the interior of each cell is also deeply related to the structure of its boundary through σ isomorphisms. We hence have to grant that the interior of each cell does not convey itself any multi-incidence (see for instance Fig. 13, in which no multi-incidence occurs).

Moreover, by definition, the boundary of any main cell of a subdivision encoded by a chain of surfaces is also closed and connected (as it is a k -surface for some k). Involved switch_i -operators have hence no fixed point. We will see below how switch_i -operators are related to α_i -involutions. And from here we focus on chains of maps whose involutions have no fixed point. This constraint

is anyway required to build a suitable boundary operator on chains of maps (see theorem 4.3).

Definition 6.1 (chains of maps without multi-incidence)

An n -dimensional chain of maps without multi-incidence is an n -dimensional chain of maps $C = ((G^i = (D^i, \alpha_0^i, \dots, \alpha_{i-1}^i, \alpha_i^i = \omega))_{i=0, \dots, n}, (\sigma^i)_{i=1, \dots, n})$ such that:

1. $\forall i, 0 \leq i \leq n, (D^i, \alpha_0^i, \dots, \alpha_{i-1}^i)$ is a closed $(i - 1)$ -generalized map without multi-incidence¹⁵;
2. $\forall i, 1 \leq i \leq n, \sigma^i : D^i \longrightarrow D^{i-1}$ induces an isomorphism between the set of $\langle \alpha_0^i, \alpha_1^i, \dots, \alpha_{i-2}^i \rangle$ -orbits included in each i -cell $c^i = \langle \alpha_0^i, \alpha_1^i, \dots, \alpha_{i-1}^i \rangle$ and the set of $\langle \alpha_0^{i-1}, \alpha_1^{i-1}, \dots, \alpha_{i-2}^{i-1} \rangle$ -orbits belonging to $c^i \sigma^i$.

Roughly speaking, point 2 of the previous definition simply means that σ induces an isomorphism between the boundary of each i -cell c^i and the chain corresponding to $(D|_{c^i}, \alpha_0^i, \dots, \alpha_{i-1}^i)$.

We now focus on the relationship between chains of surfaces and this subclass of chains of maps (cf. figures 11 and 13).

Before giving explicitly the construction processes through which a chain of surfaces can be constructed from any chain of maps and reciprocally, we present some useful properties.

Property 6.2 Let $|X|$ be an n -dimensional chain of surfaces, then $\forall x^i \in X, |\alpha^\square(x^i)|$ is a connected $(i - 1)$ -surface.

Proof. This property actually comes from the very definition when x^i is a main cell of the subdivision. Any other i -dimensional element x^i of the chain of surfaces belongs to a p -surface, where p is the dimension of a main cell having x^i in its α -adherence: $\alpha^\square(x^i)$ is also hence a connected $(i - 1)$ -surface (see proof in [DCB05]). \square

Property 6.3 Let $|X|$ be an n -dimensional chain of surfaces, each suborder built on $X^i = \bigcup_{x^i \in X} \{\alpha(x^i)\}$, $i \in \{0, \dots, n\}$, is itself a chain of surfaces whose each \mathbf{switch}_k^i -operator, $k \in \{0, \dots, i - 1\}$, is simply the restriction of the \mathbf{switch}_k -operator of X on X^i .

Proof. Main cells of such a suborder are i -cells of the original order. Their strict α -adherences are hence $(i - 1)$ -surfaces (Property 6.2). This corresponds precisely to the definition of chains of surfaces (see definition 3.1). The construction of \mathbf{switch} -operators is straightforward. \square

¹⁵An n -gmap is without multi-incidence [ADLL08] if and only if $\forall d \in D, \forall I \subseteq N, \langle \rangle_{N-\{I\}}(d) = \bigcap_{i \in I} \langle \rangle_{N-\{i\}}(d)$.

Theorem 6.4 (construction of an n -dimensional chain of maps from an n -dimensional chain of surfaces) Let $|X|$ be an n -dimensional chain of surfaces.

1. $\forall i \in \{0, \dots, n\}$, let D^i be the set of all i - α^\bullet -chains of $|X|$ rooted at some element of rank i , i.e. $D^i = \{i\text{-}\alpha^\bullet\text{-chains of } \alpha(x^i), x^i \in X\}$;
2. $\forall i \in \{0, \dots, n\}$, $\forall k \in \{0, \dots, i-1\}$, let α_k^i be the involution \mathbf{switch}_k^i induced on the chain of surfaces $|\bigcup_{x^i \in X} \{\alpha(x^i)\}|$;
3. $\forall i \in \{1, \dots, n\}$, let σ^i be the application which associates to each i - α^\bullet -chain of $|\alpha(x^i)|$, $(x^0, \dots, x^{i-1}, x^i)$, the $(i-1)$ - α^\bullet -chain of $|\alpha(x^{i-1})|$, (x^0, \dots, x^{i-1}) .

Then $C = ((D^i, \alpha_0^i, \dots, \alpha_{i-1}^i, \alpha_i^i = \omega)_{i \in \{0, \dots, n\}}, \{\sigma^i\}_{i \in \{1, \dots, n\}})$, where ω is undefined on D^i , $\forall i \in \{0, \dots, n\}$, is an n -dimensional chain of maps without multi-incidence whose main cells have closed connected boundaries.

Proof. In the sequel we denote by $D_{|Y}^k$ where Y is a k -dimensional suborder of $|X|$, the set of k - α^\bullet -chains belonging to Y . First note that each set D^i can be decomposed into the disjoint union of restrictions of D^i to suborders $|\alpha(x^i)|$, i.e. $D^i = \bigcup_{x^i \in |X|} D_{|\alpha(x^i)}^i$.

1. We first prove that, $\forall i \in \{0, \dots, n\}$, $(D^i, \alpha_0^i, \dots, \alpha_{i-1}^i, \alpha_i^i = \omega)$ is an i -dimensional generalized map where α_i^i is undefined on D^i .

As $|X|$ is an n -dimensional chain of surfaces, each $\alpha^\square(x^i)$ is a connected $(i-1)$ -surface (see property 6.2).

$(D_{|\alpha^\square(x^i)}^{i-1}, \mathbf{switch}_0^{i-1}, \dots, \mathbf{switch}_{i-1}^{i-1})$ is hence a closed connected $(i-1)$ -generalized map without multi-incidence [ADLL08]. Moreover there is an isomorphism ϕ_{x^i} between $(D_{|\alpha^\square(x^i)}^{i-1}, \mathbf{switch}_k^{i-1})$ and $(D_{|\alpha(x^i)}^i, \mathbf{switch}_k^i)$, which associates to each $(i-1)$ -chain (x^0, \dots, x^{i-1}) the i -chain $(x^0, \dots, x^{i-1}, x^i)$.

Hence $\forall i \in \{0, \dots, n\}$, $(D^i, \alpha_0^i, \dots, \alpha_{i-1}^i, \omega)$ is a closed i -generalized map without multi-incidence made of several connected components, each corresponding to some i -dimensional cell of the order;

2. Both equalities involving σ^i are quite straightforward. Actually when $i \geq 2$:

$$(a) \quad d\alpha_k^i \sigma^i = d\sigma^i \alpha_k^{i-1}, \text{ for } 0 \leq k \leq i-2$$

$$\begin{aligned} d\alpha_k^i \sigma^i &= (x^0, \dots, x^{k-1}, x^k, x^{k+1}, \dots, x^{i-1}, x^i) \alpha_k^i \sigma^i \\ &= (x^0, \dots, x^{k-1}, x^k, x^{k+1}, \dots, x^{i-1}, x^i) \sigma^i \\ &= (x^0, \dots, x^{k-1}, x^k, x^{k+1}, \dots, x^{i-1}) \\ &= (x^0, \dots, x^{k-1}, x^k, x^{k+1}, \dots, x^{i-1}) \alpha_k^{i-1} \\ &= (x^0, \dots, x^{k-1}, x^k, x^{k+1}, \dots, x^{i-1}, x^i) \sigma^i \alpha_k^{i-1} \\ &= d\sigma^i \alpha_k^{i-1} \end{aligned}$$

$$(b) \quad d\alpha_{i-1}^i \sigma^i \sigma^{i-1} = d\sigma^i \sigma^{i-1}$$

$$\begin{aligned} d\alpha_{i-1}^i \sigma^i \sigma^{i-1} &= (x^0, \dots, x^{i-1}, x^i) \alpha_{i-1}^i \sigma^i \sigma^{i-1} \\ &= (x^0, \dots, x^{i-1}, x^i) \sigma^i \sigma^{i-1} \\ &= (x^0, \dots, x^{i-1}) \sigma^{i-1} \\ &= (x^0, \dots, x^{i-2}) \end{aligned}$$

$$\begin{aligned} d\sigma^i \sigma^{i-1} &= (x^0, \dots, x^{i-1}, x^i) \sigma^i \sigma^{i-1} \\ &= (x^0, \dots, x^{i-1}) \sigma^{i-1} \\ &= (x^0, \dots, x^{i-2}) \end{aligned}$$

3. σ^i is, by construction, a one-to-one mapping between the i - α^\bullet -chains of $\alpha(x^i)$, $D_{|\alpha(x^i)}^i$ and the $(i-1)$ - α^\bullet -chains of $\bigcup_{x^{i-1} \in \alpha(x^i)} \alpha(x^{i-1})$, $D_{|\bigcup_{x^{i-1} \in \alpha(x^i)}}^{i-1}$. Moreover by definition of switch-operators, σ^i is an isomorphism between $(D_{|\alpha(x^i)}^i, \mathbf{switch}_k^i)$ and $(D_{|\bigcup_{x^{i-1} \in \alpha(x^i)}}^{i-1}, \mathbf{switch}_k^{i-1})$, $\forall k \in 0, \dots, i-2$.

Finally, as each $\alpha^\square(x^i)$ is an $(i-1)$ -surface, it is chain-connected [ADLL08] which means that there exists an isomorphism between the set $\{\alpha(x^{i-1}), x^{i-1} \in \alpha^\square(x^i)\}$ and the set of $\langle \mathbf{switch}_0^i, \dots, \mathbf{switch}_{i-2}^i \rangle$ -orbits of D^i . The chain of maps fulfills hence item 2 of definition 6.1. □

Theorem 6.5 (construction of an n -dimensional chain of surfaces from an n -dimensional chain of maps without multi-incidence) Let $C = ((D^i, \alpha_0^i, \dots, \alpha_{i-1}^i, \alpha_i^i = \omega)_{i \in \{0, \dots, n\}}, \{\sigma^i\}_{i \in \{1, \dots, n\}})$ be an n -dimensional chain of maps without multi-incidence, where ω is undefined on D^i , $\forall i \in \{0, \dots, n\}$.

1. $\forall i \in \{0, \dots, n\}$, let X^i be the set of $\langle \alpha_0^i, \dots, \alpha_{i-1}^i \rangle$ -orbits, i.e. of connected components, of $(D^i, \alpha_0^i, \dots, \alpha_{i-1}^i, \alpha_i^i = \omega)$. Let us denote by X the set:

$$\bigcup_{\substack{x^i \in X^i \\ i=0, \dots, n}} \{x^i\}$$

2. let α^\square be defined on $X \times X$, as the transitive closure of the relation α^\bullet :

$$x^{i-1} \in \alpha^\bullet(x^i) \Leftrightarrow D_{x^{i-1}}^{i-1} \subseteq D_{x^i}^i \sigma^i$$

where the orbit represented by $x^i \in X^i$ is denoted by $D_{x^i}^i$

and let $\alpha = \alpha^\square \cup (x, x)$.

Then $|X| = (X, \alpha)$ is an n -dimensional chain of surfaces.

- Proof.**
1. By construction of α , $|X|$ is obviously an order;
 2. Let x^i be a main cell of $|X|$. As the chain of maps is without multi-incidence, σ^i induces an isomorphism between the boundary of x^i , i.e. $\alpha^\square(x^i)$ and the corresponding gmap $(D|_{C^i}, \alpha_0^i, \dots, \alpha_{i-1}^i)$, which is a closed connected $(i-1)$ -generalized map without multi-incidence. $\alpha^\square(x^i)$ is hence an $(i-1)$ -surface [ADLL08].

□

Note also that the \mathbf{switch}_k^i -operators, $k \in \{1, \dots, i-1\}$, naturally induced on each $|\alpha(x^i)|$ are deeply related to the α_k^i involutions of the corresponding map (see [Bri93]).

Finally, constructions described in theorems 6.4 and 6.5 are inverse to each other up to isomorphism. Actually, the first one builds a chain of maps whose set of i -cells is in bijection with the set of $\{\alpha(x^i), x^i \in X\}$ of the chain of surfaces. The second builds a chain of surfaces whose set of i -cells is in bijection with the set of i -cells of the chains of maps and there is a straightforward bijection between the set of i -cells and the set of α -adherences of i -cells. Moreover two darts of G^i related by some α_k correspond to two i - α^\bullet -chains of the corresponding chain of surfaces related by \mathbf{switch}_k^i and reciprocally.

The equivalence between both structures leads to useful properties.

Property 6.6 *Let $C = ((D^i, \alpha_0^i, \dots, \alpha_{i-1}^i, \alpha_i^i = \omega)_{i \in \{0, \dots, n\}}, \{\sigma^i\}_{i \in \{1, \dots, n\}})$ and $|X| = (X, \alpha)$ be equivalent n -dimensional chain of maps without multi-incidence and n -dimensional chain of surfaces, then the following properties hold:*

1. $\forall i \in \{1, \dots, n\}, \forall k \in \{0, \dots, i-1\}, x^k \in \alpha(x^i) \Leftrightarrow D_{x^k}^k \subseteq D_{x^i}^i \sigma^i \sigma^{i-1} \dots \sigma^k$;
2. $\forall p \in \{1, \dots, n\}, (p+1)$ - α -chain $(x^{k_0}, \dots, x^{k_p}) \Leftrightarrow \langle \rangle_{I - \{k_0, \dots, k_p\}}(d) \subseteq D_{x^{k_p}}^{k_p}$ where $I = [0, \dots, k_p]$ and d corresponds to a (k_p+1) - α^\bullet -chain containing $(x^{k_0}, \dots, x^{k_p})$;
3. $\forall p \in \{1, \dots, n\}, \forall k \in \{1, \dots, p\}$, if d^p corresponds to the $(p+1)$ -chain (x^0, \dots, x^p) then $d^p \sigma^p \dots \sigma^{k+1}$ corresponds to the $(k+1)$ -chain (x^0, \dots, x^k) .

- Proof.**
1. directly comes from transitivity of α and point 2 of theorem 6.5;
 2. directly comes points 1 and 2 of theorem 6.4;
 3. it is highly related to point 1.

□

The correspondences between a chain of surfaces and a chain of maps representing the same subdivision are displayed on Table 1.

chain of surfaces (X, α)	chain of maps ($G_{i \in \{0, \dots, n\}}^i, \sigma_{i \in \{1, \dots, n\}}^i$)
$\alpha(x^i)$ \Downarrow x^i	connected component of G^i : $D_{\alpha(x^i)}^i$ \Downarrow i -cell
$x^k \in \alpha(x^i)$	$D_{x^k}^k \subseteq D_{x^i}^i \sigma^i \sigma^{i-1} \dots \sigma^k$
$(i+1)$ - α^\bullet -chain (x^0, \dots, x^i)	$d^i \in D^i$
switch $_k^i$	α_k^i
$(p+1)$ - α -chain $(x^{k_0}, \dots, x^{k_p})$ \Downarrow $\langle \mathbf{switch}_k^{k_p} \rangle_{k \in K^p \setminus \{k_0, \dots, k_p\}}$ where $K^p = [0, \dots, k_p]$	$\langle \alpha_k^{k_p} \rangle_{k \in K^p \setminus \{k_0, \dots, k_p\}} \subseteq D_{x^{k_p}}^{k_p}$ where $K^p = [0, \dots, k_p]$

Table 1: Correspondence between equivalent chain of surfaces and chain of maps.

6.2 Equivalence between associated simplicial objects

The topology of both incidence graphs and chains of maps is directly related to their simplicial interpretation. We focus here on equivalent chains of surfaces and chains of maps. It means that there is no multi-incidence in the associated subdivision, and that associated numbered simplicial sets are numbered simplicial complexes. The numbered simplices associated with an incidence graph (see page 9) are built on its α -chains, whereas numbered simplices associated with a chain of maps are built on orbits of darts (see Section 5.1 page 37).

More precisely a numbered j -simplex of a chain of surfaces is a $(j+1)$ - α -chain, $(x^{k_0}, \dots, x^{k_{j-1}}, x^i)$, which is naturally included in $\alpha(x^i)$. Let us recall that the number of each vertex is the rank of the corresponding element in the order, i.e. the simplex is numbered $\{k_0, \dots, k_{j-1}, i\}$. A j -simplex of a chain of maps, numbered (k_0, \dots, k_{j-1}, i) , is an orbit $\langle \rangle_{I - \{k_0, \dots, k_{j-1}, i\}}$ of $D_{\alpha(x^i)}^i$, where $I = [0, \dots, i]$. According to property 6.6.2, there is hence a bijection between the set of i -simplices associated to a chain of surfaces and the set of i -simplices associated to its corresponding chain of maps (see Table 2).

simplicial complex	chain of surfaces (X, α)	chain of maps ($G_{i \in \{0, \dots, n\}}, \sigma_{i \in \{1, \dots, n\}}^i$)
j -simplex	$(x^{k_0}, \dots, x^{k_{j-1}}, x^i)$	$\langle \rangle_{I - \{k_0, \dots, k_{j-1}, i\}} (D_{\alpha(x^i)}^i)$

Table 2: Simplicial correspondence between equivalent chain of surfaces and chain of maps.

Face relations between simplices are preserved by this bijection. Let $S_S^j = (x^{k_0}, \dots, x^{k_{j-1}}, x^i)$ and $S_M^j = T(\langle \rangle_{I - \{k_0, \dots, k_{j-1}, i\}}(d^i))$ be two corresponding simplices respectively associated with a chain of surfaces and an equivalent chain of maps. The face of S_S^j , obtained through d_l -operator, $l \in \{k_0, \dots, k_{j-1}, i\}$ is the $(j-1)$ -simplex obtained by removing x^l from S_S^j .

When $l \neq i$, the smallest cell of the subdivision containing the $(j-1)$ -simplex remains x^i . The image of this j - α -chain is simply the orbit $\langle \rangle_{I - \{k_0, \dots, \hat{l}, \dots, k_{j-1}, i\}}(d^i)$. The corresponding simplex is hence $T(\langle \rangle_{I - \{k_0, \dots, \hat{l}, \dots, k_{j-1}, i\}}(d^i))$, which is equal to $T(\langle \rangle_{I - \{k_0, \dots, k_{j-1}, i\}}(d^i))d_l$.

When $l = i$, then the smallest cell of the subdivision containing the $(j-1)$ -simplex is $x^{k_{j-1}}$. The image of $(x^{k_0}, \dots, x^{k_{j-1}})$ is the orbit $\langle \rangle_{[0, k_{j-1}] - \{k_0, \dots, k_{j-1}\}}(d^{k_{j-1}})$ where $d^{k_{j-1}} = d^i \sigma^i \sigma^{i-1} \dots \sigma^{k_{j-1}+1}$.

6.3 Unsigned boundary operators equivalence

As there is no multi-incidence in this context, the unsigned incidence number linking two cells is either equal to 1 or to 0.

We proved that there is a bijection between the set of cells associated to a chain of surfaces and the set of cells associated to the corresponding chain of maps. We just need to show that the unsigned incidence number between any two cells of the subdivision is preserved through this bijection which grants that boundary operators are equivalent and lead to same homology.

First note that definition 4.2 of unsigned incidence number on chain of maps (page 30) implies that when there is no multi-incidence ($c^i(d^i) : c^{i-1}(d^{i-1}) = 1$) is equivalent to $D_{x^{i-1}(d^{i-1})}^{i-1} \subseteq D_{x^i(d^i)} \sigma^i$.

The equivalence between both unsigned incidence numbers comes then from the fact that $x^{i-1} \in \alpha(x^i)$, i.e. $(x^i : x^{i-1}) = 1$ implies that $D_{x^{i-1}}^{i-1} \subseteq D_{x^i} \sigma^i$ and reciprocally.

6.4 Signed boundary operators equivalence

Like above, there is no multi-incidence, and the signed incidence number linking two cells is either equal to 1, -1 or 0.

The value of this number depends on the value of the unsigned incidence number and on the relative orientation of both cells. We hence have to prove that orienting a chain of surfaces and a chain of maps lead to the same signed incidence number.

Orienting the cells of a chain of surfaces consists in marking each α^\bullet -relation with a $+$ or a $-$. Based on these orientations, a sign can also be associated with each i - α^\bullet -chain as the product of all signs of α^\bullet -relations included in the chain. Due to the orientation process, two i - α^\bullet -chains obtained from one another by a switch_k -operator, $k \in \{0, \dots, i-1\}$, have different signs. Indeed they differ only on one branch on the diamond configuration related to switch_k . Otherwise said, the orientation of i - α^\bullet -chains leads to a consistent orientation of darts of D^i .

On the contrary, let d^i and d^{i-1} be two oriented darts of D^i and D^{i-1} , such that $d^i \sigma^i = d^{i-1}$. Let x^i and x^{i-1} the cells corresponding to the connected component of D^i and D^{i-1} respectively associated with d^i and d^{i-1} . Let us mark the α^\bullet -relation between x^{i-1} and x^i by the product of the signs of d^i and d^{i-1} . Note that this sign does not depend on the chosen darts. Let us consider a diamond configuration i.e. four cells x^{i-2} , x^{i-1} , $x^{i-1'}$, x^i such that $\{x^{i-1}, x^{i-1'}\} = \beta^\bullet(x^{i-2}) \cap \alpha^\bullet(x^i)$. Let d^i and $d^{i'}$ be darts corresponding to two α -chains containing respectively x^{i-2} , x^{i-1} , x^i , and x^{i-2} , $x^{i-1'}$, x^i . Let d^{i-1} , $d^{i-1'}$ be darts corresponding to both previous chains where x^i was removed. And let d^{i-2} be the dart associated with the intersection of both chains and $\alpha(x^{i-2})$. By construction $d^i = d^{i'} \alpha_{i-1}^i$. Both darts have hence opposite signs. Then:

$$\begin{aligned}
& sg(x^i, x^{i-1}) * sg(x^{i-1}, x^{i-2}) + sg(x^i, x^{i-1'}) * sg(x^{i-1'}, x^{i-2}) \\
&= (sg(d^i) * sg(d^{i-1})) * (sg(d^{i-1}) * sg(d^{i-2})) \\
&\quad + (sg(d^{i'}) * sg(d^{i-1'})) * (sg(d^{i-1'}) * sg(d^{i-2})) \\
&= sg(d^i) * sg(d^{i-2}) + sg(d^{i'}) * sg(d^{i-2}) \\
&= 0
\end{aligned}$$

A consistent orientation has hence been defined on the chain of surfaces.

Correspondences between orientations	
chain of surfaces	chain of maps
$\prod_{k=1}^{k=i} sg(x^k : x^{k-1})$	$sg(d^i)$ where d^i corresponds to (x^0, x^1, \dots, x^i)
$sg(x^i : x^{i-1})$	$sg(d^i(x^i)) * sg(d^{i-1}(x^{i-1}))$ where $d^{i-1}(x^{i-1}) = d^i(x^i) \sigma^i$

The signed incidence numbers on chain of surfaces and chain of maps are hence equal.

Moreover definition 4.5 of signed incidence number on chains of maps (page 33) can be simplified when there is no multi-incidence. In this context, the signed incidence number ($c^i : c^{i-1}$) is equal to 1 if there exists d^i in c^i such

that $d^i \sigma^i$ in c^{i-1} and $sg(d^i) = sg(d^i \sigma^i)$. It is equal to -1 if there exists d^i in c^i such that $d^i \sigma^i$ in c^{i-1} and $sg(d^i) = -sg(d^i \sigma^i)$. Else it is equal to 0 .

7 Generalized maps

7.1 Definition

Definitions of boundary operators have been proposed in [APDL09] in order to optimize the computation of the homology groups of generalized maps. We recall here these definitions, and we show that the so-defined homology of a generalized map is equivalent to the simplicial homology of the associated quasi-manifold. The proof of this equivalence is based upon the relations between a chain of maps corresponding to a quasi-manifold and the associated generalized map, which can be explained in the following way.

An homogeneous (or pure) n -dimensional chain of map $C = ((G^i)_{i=0,\dots,n}, (\sigma^i)_{i=1,\dots,n})$ is such that any i -cell is incident to an n -cell, for $0 \leq i \leq n-1$ [EL94]. We can then define an equivalent structure $C' = (G^n, (R^i)_{i=0,\dots,n-1})$, where $(R^i)_{i=0,\dots,n-1}$ are equivalence relations between the darts of G^n , such that two darts b and b' satisfy relation R^i if and only if they have the same image $b\sigma^n \dots \sigma^{i+1} = b'\sigma^n \dots \sigma^{i+1}$, for $0 \leq i \leq n-1$. In fact, relations $(R^i)_{i=0,\dots,n-1}$ implicitly represent the i -cells, and they satisfy properties which can be deduced from the definition of the chains of maps.

When the chain of maps corresponds to a quasi-manifold, this structure can again be simplified: it is sufficient to explicitly represent n -cells and relation R^{n-1} , since n -cells are glued along $(n-1)$ -cells; the equivalence classes of R^{n-1} contain each two darts, since at most two n -cells share an $(n-1)$ -cell. R^{n-1} can thus be represented by an involution, namely α_n , and we get the definition of generalized maps.

Moreover, since we consider chains of maps in which σ^{i+1} , for $0 \leq i \leq n-1$, is an isomorphism between orbits $\langle \alpha_0^{i+1}, \dots, \alpha_{i-1}^{i+1} \rangle$ and orbits $\langle \alpha_0^i, \dots, \alpha_{i-1}^i \rangle$ (cf. definition 4.1), we get the subclass of *generalized maps without self-bending* [ADLL08, CMP06]. A 2-gmap and a chain of maps encoding the same quasi-manifold are respectively displayed on Figure 18(a) and Figure 18(c).

A generalized map without self-bending $(D, \alpha_0, \dots, \alpha_n)$ can be iteratively constructed as follows:

Algorithm 4: Construction of a generalized map without self-bending

```

create the set of darts  $(D) = G_{-1}$  ;
for  $i=0$  to  $n-1$  do
  /* denote by  $G_{i-1} = (D, \alpha_0, \dots, \alpha_{i-1})$  the  $(i-1)$ -gmap
   constructed through the previous iteration */
  define  $G_i = (D, \alpha_0, \dots, \alpha_{i-1}, id)$  (creation of  $i$ -cells) ;
  define  $\alpha_i$  (identification of  $(i-1)$ -cells to glue  $i$ -cells) in such a way
  that it identifies only distinct  $(i-1)$ -cells ;

```

$\forall i, 0 \leq i \leq n:$

1. $\langle \alpha_0, \dots, \alpha_{i-1} \rangle(d) \cap \langle \alpha_{i+1}, \dots, \alpha_n \rangle(d) = \{d\};$
2. the simple cell $(\langle \alpha_0, \dots, \alpha_{i-1} \rangle(d), \alpha_0, \dots, \alpha_{i-1})$ is isomorphic to the compacted cell $cc^i = (c^i(d)/\langle \alpha_{i+1}, \dots, \alpha_n \rangle, \alpha_0, \dots, \alpha_{i-1})$, where $c^i(d) = \langle \alpha_0, \dots, \alpha_{i-1}, \alpha_{i+1}, \dots, \alpha_n \rangle(d)$. More precisely, $c^i(d)/\langle \alpha_{i+1}, \dots, \alpha_n \rangle$ means that a dart is associated with each orbit $\langle \alpha_{i+1}, \dots, \alpha_n \rangle$ of $c^i(d)$; since $\alpha_k \alpha_l = \alpha_l \alpha_k$ for $k \leq l - 2$, we get (by abuse of notations) that $(\langle \alpha_{i+1}, \dots, \alpha_n \rangle(d'))\alpha_k = \langle \alpha_{i+1}, \dots, \alpha_n \rangle(d\alpha_k)$ for $0 \leq k \leq i - 1$ (see Fig. 15).

This property is a direct consequence of the following properties of chains of maps, as stated by the following lemma:

Lemma 7.2 Let $C = ((G^i)_{i=0, \dots, n}, (\sigma^i)_{i=1, \dots, n})$ be a chain of map, as defined in definition 4.1. $\forall 0 \leq i < k \leq n, \forall d:$

1. let $d' \in \langle \alpha_{i+1}^k, \dots, \alpha_{k-1}^k \rangle(d)$; then $d' \sigma^k \dots \sigma^{i+1} = d \sigma^k \dots \sigma^{i+1}$;
2. the simple cells $(\langle \alpha_0^k, \dots, \alpha_{i-1}^k \rangle(d), \alpha_0^k, \dots, \alpha_{i-1}^k)$ and $(\langle \alpha_0^i, \dots, \alpha_{i-1}^i \rangle(d \sigma^k \dots \sigma^{i+1}), \alpha_0^i, \dots, \alpha_{i-1}^i)$ are isomorphic to each other;
3. $\langle \alpha_0^k, \dots, \alpha_{i-1}^k \rangle(d) \cap \langle \alpha_{i+1}^k, \dots, \alpha_{k-1}^k \rangle(d) = \{d\};$
4. the compacted cell:
 $(\langle \alpha_0^k, \dots, \alpha_{i-1}^k, \alpha_{i+1}^k, \dots, \alpha_{k-1}^k \rangle(d)/\langle \alpha_{i+1}^k, \dots, \alpha_{k-1}^k \rangle, \alpha_0^k, \dots, \alpha_{i-1}^k)$ is isomorphic to $(\langle \alpha_0^i, \dots, \alpha_{i-1}^i \rangle(d \sigma^k \dots \sigma^{i+1}), \alpha_0^i, \dots, \alpha_{i-1}^i)$.

Proof. 1. let $d' \in \langle \alpha_{i+1}^k, \dots, \alpha_{k-1}^k \rangle(d)$.

Then $d' = d \alpha_{j_1}^k \dots \alpha_{j_p}^k$, with $j_1, \dots, j_p \in [i+1, k-1]$. $d' \sigma^k \dots \sigma^{i+1} = d \alpha_{j_1}^k \dots \alpha_{j_{p-1}}^k \sigma^k \dots \alpha_{j_p}^{j_p+1} \sigma^{j_p+1} \sigma^{j_p} \dots \sigma^{i+1} = d \alpha_{j_1}^k \dots \alpha_{j_{p-1}}^k \sigma^k \dots \sigma^{i+1}$, due to the properties 2a and 2b of α and σ operators in definition 4.1. By iterating on indices j_1, \dots, j_{p-1} , we get the result;

2. since $\forall i+1 \leq j \leq k$, σ^j is an isomorphism between $(\langle \alpha_0^j, \dots, \alpha_{j-2}^j \rangle(d \sigma^k \dots \sigma^{j+1}), \alpha_0^j, \dots, \alpha_{j-2}^j)$ and $(\langle \alpha_0^{j-1}, \dots, \alpha_{j-2}^{j-1} \rangle(d \sigma^k \dots \sigma^j), \alpha_0^{j-1}, \dots, \alpha_{j-2}^{j-1})$, it is thus an isomorphism between $(\langle \alpha_0^j, \dots, \alpha_{i-1}^j \rangle(d \sigma^k \dots \sigma^{j+1}), \alpha_0^j, \dots, \alpha_{i-1}^j)$ and $(\langle \alpha_0^{j-1}, \dots, \alpha_{i-1}^{j-1} \rangle(d \sigma^k \dots \sigma^j), \alpha_0^{j-1}, \dots, \alpha_{i-1}^{j-1})$. The composition of isomorphisms is an isomorphism, and we get the result;
3. assume a dart d' exist, such that $d' \neq d$ and $d' \in \langle \alpha_0^k, \dots, \alpha_{i-1}^k \rangle(d) \cap \langle \alpha_{i+1}^k, \dots, \alpha_{k-1}^k \rangle(d)$. Then $d' = d \alpha_{j_1}^k \dots \alpha_{j_m}^k = d \alpha_{j_{m+1}}^k \dots \alpha_{j_p}^k$ with $j_1, \dots, j_m \in [0, i-1]$ and $j_{m+1}, \dots, j_p \in [i+1, k-1]$.

But $d\alpha_{j_{m+1}}^k \dots \alpha_{j_p}^k \sigma^k \dots \sigma^{i+1} = d\sigma^k \dots \sigma^{i+1} = d'\sigma^k \dots \sigma^{i+1}$. So we have two different darts d and d' of orbit $\langle \alpha_0^k, \dots, \alpha_{i-1}^k \rangle(d)$ which have the same image by $\sigma^k \dots \sigma^{i+1}$ in orbit $\langle \alpha_0^i, \dots, \alpha_{i-1}^i \rangle(d\sigma^k \dots \sigma^{i+1})$: contradiction with the fact that $\sigma^k \dots \sigma^{i+1}$ is an isomorphism between these orbits;

4. we consider $c^i = \langle \alpha_0^k, \dots, \alpha_{i-1}^k, \alpha_{i+1}^k, \dots, \alpha_{k-1}^k \rangle(d)$.

All darts of an orbit $\langle \alpha_{i+1}^k, \dots, \alpha_{k-1}^k \rangle$ contained in c^i have the same image by $\sigma^k \dots \sigma^{i+1}$, and all orbits $\langle \alpha_0^k, \dots, \alpha_{i-1}^k \rangle$ are isomorphic, since they are isomorphic to $\langle \alpha_0^i, \dots, \alpha_{i-1}^i \rangle(d\sigma^k \dots \sigma^{i+1})$ by $\sigma^k \dots \sigma^{i+1}$. We can thus extend the definition of $\sigma^k \dots \sigma^{i+1}$ onto orbits $\langle \alpha_{i+1}^k, \dots, \alpha_{k-1}^k \rangle$, and orbit $c^i / \langle \alpha_{i+1}^k, \dots, \alpha_{k-1}^k \rangle$ is isomorphic by $\sigma^k \dots \sigma^{i+1}$ to $\langle \alpha_0^i, \dots, \alpha_{i-1}^i \rangle(d\sigma^k \dots \sigma^{i+1})$.

□

7.2 Boundary operators

With this equivalence, we can thus extend the results presented above for chains of maps onto generalized maps. First, we define the unsigned incidence numbers:

Definition 7.3 (unsigned incidence number) *Let $i \in \{1, \dots, n\}$. Let $c^i(d)$ and $c^{i-1}(d')$ be two cells of G . The unsigned incidence number, $(c^i(d) : c^{i-1}(d'))$, is:*

$$\text{card}(\{\langle \alpha_{i+1}, \dots, \alpha_n \rangle(d'') \subseteq \langle \alpha_i, \dots, \alpha_n \rangle(d') \text{ s.t. } \langle \alpha_{i+1}, \dots, \alpha_n \rangle(d'') \subseteq c^i(d)\}).$$

This definition is a direct translation of the unsigned incidence numbers on chains of maps. We can simplify the definition in the following way : $(c^i(d) : c^{i-1}(d')) = \text{card}(\{\langle \alpha_{i+1}, \dots, \alpha_n \rangle(d'') \text{ s.t. } d'' \in \langle \alpha_i, \dots, \alpha_n \rangle(d') \text{ and } d'' \in c^i(d)\})$.

As for chain of map, we can provide the following alternative definition: let $\{p_j\}_{j=1 \dots k}$ be a set of darts such that the orbits $\{\langle \alpha_0, \dots, \alpha_{i-2} \rangle(p_j)\}_{j=1 \dots k}$ make a partition of $\langle \alpha_0, \dots, \alpha_{i-1} \rangle(d)$; then $(c^i : c^{i-1}) = \text{card}(\{p_j, j = 1 \dots k \mid p_j \in c^{i-1}\})$.

Then we define the signed incidence numbers, for gmaps which cells are orientable, i.e. for any i -cell $c^i = \langle \alpha_0, \dots, \alpha_{i-1}, \alpha_{i+1}, \dots, \alpha_n \rangle(d)$, there are two orbits $\langle \alpha_0\alpha_1, \dots, \alpha_0\alpha_{i-1}, \alpha_0\alpha_{i+1}, \dots, \alpha_0\alpha_n \rangle(d)$ and $\langle \alpha_0\alpha_1, \dots, \alpha_0\alpha_{i-1}, \alpha_0\alpha_{i+1}, \dots, \alpha_0\alpha_n \rangle(d\alpha_0)$ (cf. [Lie94] and section 8). We then choose an orientation for the associated compacted cell, i.e. each dart d of the i -cell is marked with a sign (+ or -) denoted $sg^i(d)$ such that $sg^i(d) \neq sg^i(d\alpha_j) \forall j: 0 \leq j < i$, and $sg^i(d) = sg^i(d\alpha_j) \forall j: i < j \leq n$ ¹⁶. Note that, as for chain of maps, the gmap itself can be not orientable.

Definition 7.4 (signed incidence number) *Let $i \in \{1, \dots, n\}$. Let $c^i(d)$ and $c^{i-1}(d')$ be two cells of G . The signed incidence number, $(c^i(d) : c^{i-1}(d'))$,*

¹⁶This definition is equivalent to the one given in [APDL09].

is:

$$\sum_{\substack{\langle \alpha_{i+1}, \dots, \alpha_n \rangle (d'') \subseteq \langle \alpha_i, \dots, \alpha_n \rangle (d') \\ \text{s.t. } d'' \in c^i(d)}} sg^i(d'').sg^{i-1}(d')$$

It has been shown in [APDL09] that the incidence number does not depend on the chosen darts, and thus that the definitions are consistent. As for unsigned incidence number, we will use the following alternative definition: let $\{p_j\}_{j=1 \dots k}$ be a set of darts such that the orbits $\{\langle \alpha_0, \dots, \alpha_{i-2} \rangle (p_j)\}_{j=1 \dots k}$ make a partition of $\langle \alpha_0, \dots, \alpha_{i-1} \rangle (d)$; then $(c^i : c^{i-1}) = \sum_{p_j, j=1 \dots k | p_j \in c^{i-1}} sg^i(p_j).sg^{i-1}(p_j)$.

Let ∂_M be the corresponding boundary operator, according to definition 2.9: we can easily prove that ∂_M satisfies $\partial_M \partial_M = 0$ when involutions α_i are without fixed points for $0 \leq i \leq n - 1$. Moreover, we have:

Theorem 7.5 *The homologies defined on gmaps by these boundary operators are equivalent to the simplicial homologies of the associated quasi-manifolds when the homology of the canonical boundary of each i -cell is that of an $(i - 1)$ -sphere.*

Proof. We have mentioned above the equivalence between chains of maps such that all involutions are without fixed points, and generalized maps without self-bending, such that all involutions except α_n are without fixed points. This equivalence still holds when the cells are orientable. We can also show easily that a generalized map and its corresponding chain of maps correspond to the same quasi-manifold, and that the incidence numbers defined for the generalized map are the same as those defined for the associated chain of maps. The result comes from the fact that the homology of the chain of map is equivalent to the homology of the quasi-manifold.

□

7.3 Algorithms

We present now Algorithm 5 allowing to compute the incidence number $(c^i : c^{i-1})$. The only difference with the same algorithm for chains of maps (cf. Algorithm 2) is the way that we now consider cells. Indeed, contrary to chains of maps, the darts of all the i -cells, $\forall i : 0 \leq i \leq n$ in relation by σ are now represented by only one dart in the gmap, thus we take the same dart c to consider i -cells and $(i - 1)$ -cells.

This algorithm is the direct translation of the alternative definition of the signed incidence number presented above. In order to consider all darts p_j such that the orbits $\{\langle \alpha_0, \dots, \alpha_{i-2} \rangle (p_j)\}_{j=1 \dots k}$ make a partition of $\langle \alpha_0, \dots, \alpha_{i-1} \rangle (d)$, we run through all the darts $c \in \langle \alpha_0, \dots, \alpha_{i-1} \rangle (d)$. If c is not marked treated, that means that the orbit $\langle \alpha_0, \dots, \alpha_{i-1} \rangle (c)$ is not already considered thus we

Algorithm 5: Computation of the signed incidence number $(c^i(d) : c^{i-1}(d'))$ for gmaps

Data: $GM = (D, \alpha_0, \dots, \alpha_n)$: a signed nG map
 i : a dimension, $1 \leq i \leq n$
 d, d' : two darts of GM

Result: The signed incidence number $(c^i(d) : c^{i-1}(d'))$

```

1  $res \leftarrow 0$ ;
2 foreach dart  $c \in \langle \alpha_0, \dots, \alpha_{i-1} \rangle (d)$  do
3   if  $c$  is not marked treated and  $c \in c^{i-1}(d')$  then
4      $res \leftarrow res + sg^i(c).sg^{i-1}(c)$ ;
5     mark treated all the darts of  $\langle \alpha_0, \dots, \alpha_{i-2} \rangle (c)$ ;
6 return  $res$ ;

```

process this dart and marks all the darts of this orbit. This allows us to consider exactly all darts p_j .

We use the same principle in Algorithm 6 which computes the incidence matrix E^i . As for the chain of maps, we do not use the previous algorithm computing the incidence number but compute directly the incidence matrix to avoid to mark and unmark each dart of $c^{i-1}(d')$.

Algorithm 6: Computation of the i^{th} incidence matrix

Data: $GM = (D, \alpha_0, \dots, \alpha_n)$: a signed nG map
 i : a dimension, $0 \leq i \leq n$

Result: The incidence matrix E^i

```

1 if  $i=0$  then
2    $E^i \leftarrow \text{zeroMatrix}(\text{card}(C^0), 1)$ ;
3 else
4    $E^i \leftarrow \text{zeroMatrix}(\text{card}(C^i), \text{card}(C^{i-1}))$ ;
5   foreach dart  $d \in GM$  do
6     if  $d$  is not marked treated then
7       foreach dart  $d' \in \langle \alpha_0, \dots, \alpha_{i-1} \rangle (d)$  do
8         if  $d'$  is not marked treated then
9            $E^i(c^i(d), c^{i-1}(d')) \leftarrow$ 
10             $E^i(c^i(d), c^{i-1}(d')) + sg^i(d').sg^{i-1}(d')$ ;
11            mark treated all the darts of  $\langle \alpha_0, \dots, \alpha_{i-2} \rangle (d')$ ;
12            mark treated all the darts of  $c^i(d)$ ;
13 return  $E^i$ ;

```

The complexity of Algorithm 5 is linear in number of darts of $c^i(d) + c^{i-1}(d')$. Indeed, each dart of $c^i(d)$ is considered exactly once, and we need to mark all the darts of $c^{i-1}(d')$ before to enter in the **foreach** loop in order to be able to

test in $O(1)$ if $c \in c^{i-1}(d')$.

The complexity of Algorithm 6 is linear in number of darts of the gmap. Indeed, each dart is processed exactly once thanks to the mark, and we have a direct access to each information associated to darts.

Let us recall that these algorithms require that the gmap has all its cells oriented. Orienting an i -cell can be achieved locally in complexity linear in number of darts of the cell. Thus, the algorithm which orients each cell for each dimension of the map is linear in number of darts of the gmap times its dimension.

The algorithm computing all the incidence matrices consists in first orienting all the cells in all dimensions, and second computing all the incidence matrices E^i for all $1 \leq i \leq n$. Its overall complexity is thus also linear in number of darts of the gmap times its dimension. It is hence less expensive than simplicial homology computation over the same structure which requires to compute every possible orbit and is hence equal to the number of darts times 2 to the power of the dimension.

8 Maps

N -dimensional maps are defined in order to represent orientable quasi-manifolds without boundaries (cf. [Lie94]).

Definition 8.1 (n -map) *Let $n \geq 0$, an n -map is defined by an $(n + 1)$ -tuple $M = (D, \beta_1, \dots, \beta_n)$ such that:*

- D is a finite set of darts;
- $\beta_1 : D \rightarrow D$ is a permutation; $\forall i, 2 \leq i \leq n, \beta_i : D \rightarrow D$ is an involution;
- $\forall i, 1 \leq i \leq n - 2, \forall j, i + 2 \leq j \leq n, \beta_i \beta_j$ is an involution.

The inverse of $M = (D, \beta_1, \beta_2, \dots, \beta_n)$ is $M^{-1} = (D, \beta_1^{-1}, \beta_2, \dots, \beta_n)$.

The link with n -gmaps is the following. Let $G = (D, \alpha_0, \dots, \alpha_n)$ be a connected n -gmap without boundaries, i.e. such that α_i is without fixed points for any $0 \leq i \leq n$. Let $O = (D, \alpha_0 \alpha_1, \dots, \alpha_0 \alpha_n)$ be the n -map of the orientations of G . O has at most two connected components; G is orientable if and only if O has exactly two connected components; in this case, each connected component is the inverse of the other one (cf. Fig. 20).

Conversely, let $M = (D, \beta_1, \dots, \beta_n)$ be a connected n -map, and $M' = (D', \beta'_1, \dots, \beta'_n)$ be an n -map isomorphic to M^{-1} by ϕ . Then we can define the corresponding gmap $G = (D \cup D', \alpha_0, \dots, \alpha_n)$ with:

- for $1 \leq i \leq n, \alpha_i/D = \phi \beta'_i, \alpha_i/D' = \phi^{-1} \beta_i$;
- $\alpha_0/D = \phi, \alpha_0/D' = \phi^{-1}$.

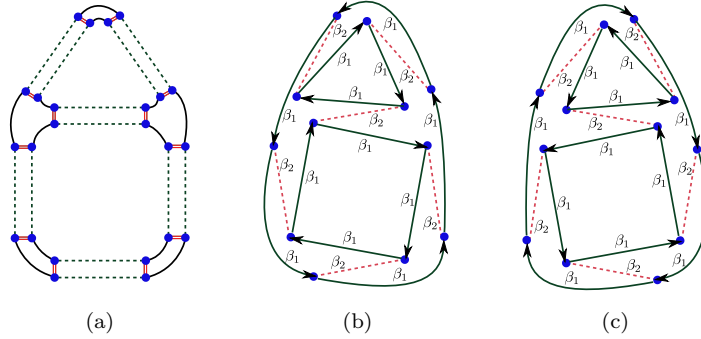

Figure 20: (a) A 2-gmap representing a decomposition of S^2 using 3 faces. (b)-(c) Its two corresponding oriented maps.

Note that the two connected components of the n -map of the orientations of G are M and M' .

We have not found a simple direct characterization of the self-bending condition that n -maps have to fulfill in order to define an homology which is equivalent to the homology of their simplicial interpretation. Given an n -dimensional map, we think the most easy way consists in computing the associated gmap, and in checking the conditions. The cost of the conversion map-gmap is linear in the size of the map, so it doesn't change the complexity of the whole computation. The main interest is here the fact that the quasi-manifold corresponding to an n -map is *torsion-free*; so *the whole topological information is got when using coefficients in $\mathbb{Z}/2\mathbb{Z}$* : the only possible values for the incidence numbers are 0 and 1. Thus, let c^{i-1} be an $(i-1)$ -cell and c^i be an i -cell, then:

$$(c^i : c^{i-1}) = \begin{cases} 0 & \text{if } c^{i-1} \text{ appears an even times in the boundary of } c^i \\ 1 & \text{otherwise} \end{cases}$$

There is a special case for dimension 1 cells to detect the case of loops (edges incident twice to the same vertex). Indeed, $(c^1(d) : c^0(d')) = 1$ if $c^0(d')$ is incident to $c^1(d)$ and $c^0(d\beta_1) \neq c^0(d')$; $(c^1(d) : c^0(d')) = 1$ otherwise.

A consequence of having coefficients in $\mathbb{Z}/2\mathbb{Z}$ is that no large integer can arise during the computation of the homology groups, when computing for instance the Smith Normal Form of the incidence matrices. We can thus use the same optimization as for computing unsigned incidence number for chain of maps, *i.e.* replace the use of integer by the use of Boolean.

However, we can use the alternative definition of incidence number for gmaps to propose the corresponding definitions for maps: let $\{p_j\}_{j=1\dots k}$ be a set of darts such that the orbits $\{\langle \beta_1, \dots, \beta_{i-2} \rangle(p_j)\}_{j=1\dots k}$ make a partition of $\langle \beta_1, \dots, \beta_{i-1} \rangle(d)$; then $(c^i : c^{i-1}) = 0$ if $\text{card}(\{p_j, j = 1 \dots k | p_j \in c^{i-1}\})$ is even; 1 otherwise. This alternative definition allows to propose algorithms similar to Algorithm 5 and Algorithm 6 to compute incidence numbers and incidence ma-

Object Cell dimension	Cellular				Simplicial			
	0	1	2	3	0	1	2	3
2-torus	151	294	142	-	588	1,770	1,180	-
Klein bottle	324	648	324	-	1,296	3,888	2,592	-
Pinion	470	701	231	-	1,402	4,206	2,804	-
Tower	228	452	226	4	910	3,824	4,928	2,016
Menger sponge	64	144	96	20	324	1,576	2,208	960

Table 3: Numbers of cells of objects shown in Fig. 21, for cellular objects, and for corresponding simplicial objects.

trices directly on oriented maps.

9 Preliminary experiments

We have implemented the computation of incidence matrices for n -gmaps, and use these matrices to compute homology of 2D and 3D object by using the method presented in [PAFL06b]. The dimension is for the moment restricted to 3D because the software used to develop these methods is *Moka* [VD03] which is for the moment only in 3D. But all the functions which compute incidence matrices and homology are generic in any dimension.

We present here some results obtained for the five objects shown in Fig. 21. The three first objects are surfacic (i.e. 2D combinatorial object embedded in 3D space) while the two last ones are 3D objects. We give in Table 3 the number of cells of each object in each dimension, and compare these numbers with the number of cells of the corresponding simplicial object. Of course we can verify that the number of cells of the cellular object is very small comparing it to the number of cells of the corresponding simplicial object, this is obvious.

Due to this important difference between the cellular and simplicial objects, we can observe in Table 4 that we need much less memory space and time to compute homology of cellular objects than for simplicial object. Once again, this is obvious, but this justifies the interest of our approach to propose a cellular framework to compute cellular homology. It must be noticed that the method implemented in *Moka* to compute homology has no optimization, thus the computation time can be much improved by using for instance optimized algorithms for computing the Smith Normal Form of the incidence matrices [DSV01, Gie96, Sto96].

10 Conclusion and perspectives

In this paper, we study the definition and computation of homology on cellular structures. Most previous works related to homology computation only deal with simplicial structures but many applications need to compute topological

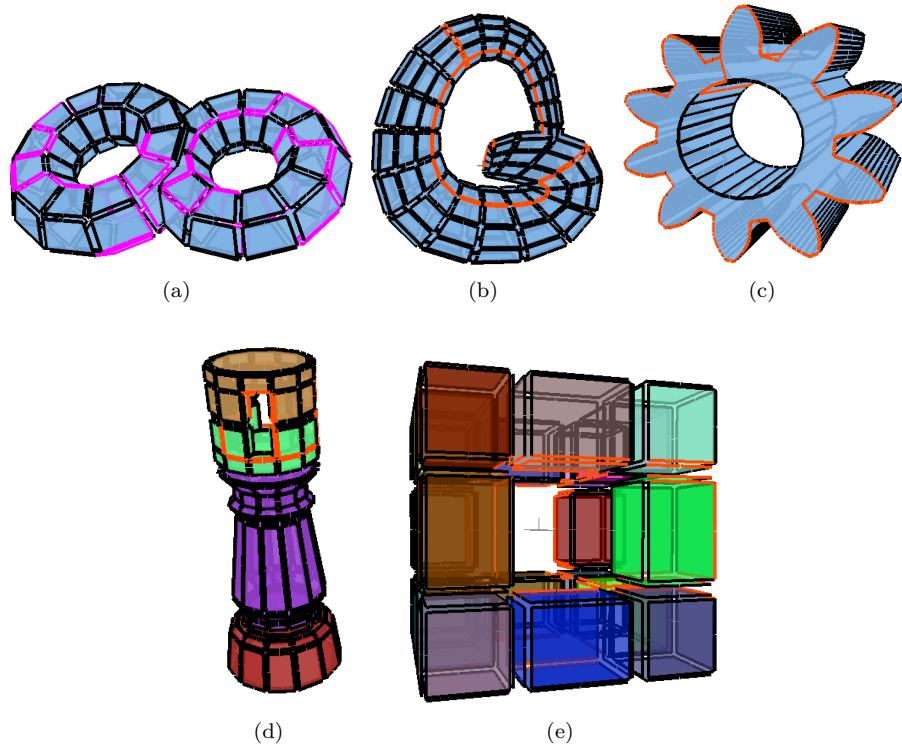

Figure 21: The five objects used in our preliminary experiments. (a) A two torus surfacic (thus a 2D combinatorial object). (b) A Klein bottle (also surfacic). (c) A pinion (surfacic). (d) A tower (volumic). (e) A Menger sponge (volumic).

Object	Cellular		Simplicial	
	memory	time	memory	time
2-torus	2.05Mb	0.18s	73Mb	134s
Klein bottle	9Mb	2.4s	352Mb	1,872s
Pinion	11Mb	4.5s	412Mb	2,228s
Tower	5.2Mb	0.7s	754Mb	4,892s
Menger sponge	0.6Mb	0.03s	143Mb	342s

Table 4: Memory space (in mega-bytes) occupied by incidence matrices and time (in seconds) for homology computation of objects shown in Fig. 21, for cellular objects, and for corresponding simplicial objects.

properties of cellular objects. In order to avoid computing the homology on the simplicial analog of cellular objects, we provide here a direct definition of homology on several cellular structures.

To achieve this objective, we study homology on the two main families of cellular structures: incidence graphs and ordered models. For each family, we exhibit a subclass that is compliant with the definition of an homology (chains of surfaces for incidence graphs, chains of maps for ordered models). The characterization of such structures is purely combinatorial. Roughly speaking they correspond to subdivisions whose cells are cellular quasi-manifolds. In this context, we define the notion of incidence numbers and use it to define a boundary operator. We study both homology over $\mathbb{Z}/2\mathbb{Z}$ which is sufficient when dealing with torsion-free objects and homology over \mathbb{Z} which encompasses all homology information for more general structures. We go on one step further with ordered models as we also study homology on two more restricted subclasses, namely generalized maps and n -maps. Our motivation is to take benefit from the specificities of both models to improve the complexity of homology computation.

To show the validity of our approach, we compare, for each studied structure, the homology of a cellular object computed with our boundary operator with the simplicial homology of its simplicial analog. We prove that both are equivalent when the boundary of each cell of the cellular object is homologically equivalent to a sphere, which is still a purely combinatorial constraint. We begin with proving it on the most general structures, i.e. the chains of maps. We then extend [ADLL08] to prove the equivalence between chains of surfaces and a subclass of chains of maps. We deduce from this correspondence the equivalence between cellular and simplicial homology on chains of surfaces. A similar equivalence for both generalized maps and n -maps is also proved as a consequence of well-known relations between such structures and chains of maps [EL94, Lie94]. Note that the cellular homology of a slightly more restricted subclass of incidence graphs has been explored by Basak in [Bas10]. The structures, he studies, belong to a subclass of chains of surfaces where two distinct cells cannot share exactly the same boundary: e.g. two edges cannot be incident to the two same vertices. Moreover the proof of the equivalence between the cellular homology and the simplicial homology of such structures follows a quite different path: the cellular structure is refined to obtain a simplicial subdivision by successively applying stellar subdivisions; it is proved that each elementary operation preserves the homology of the structure.

Apart the work of Basak [Bas10], the present study is, to our knowledge, the first one to tackle the problem of the definition and computation of a consistent cellular homology on quite generic and purely combinatorially defined cellular structures. This approach provides a natural optimization as the number of cells of a cellular structure is usually much lesser than the one of its simplicial analog. Moreover the complexity of cellular homology computation can obviously be further improved by using techniques similar to those used in the simplicial framework (e.g. optimization of matrices reductions [Sto96], elementary reductions [KMS98]).

Finally, we also design efficient algorithms on each structure to compute

cellular incidence numbers and associated incidence matrices. This computation is linear with respect to the size of the structure for chains of surfaces and chains of maps because cells are directly accessible. It is linear with respect to the size of the structure times its dimension for generalized maps and n -maps because cells are implicitly represented. Our preliminary experiments on generalized maps show the interest of our approach by comparing its efficiency to this of the classical simplicial approach. It clearly illustrates the significant gain of memory we obtain and the consequent reduction of computation time.

As future works, we plan to implement existing optimization techniques for homology computation based for instance on efficient matrices reductions in order to speed up the computation of homology groups (Betti numbers, torsion coefficients and generators).

References

- [AdFF85] S. Ansaldi, L. de Floriani, and B. Falcidieno. Geometric modeling of solid objects by using a face adjacency graph representation. *Computer Graphics*, 19(3):131–139, 1985.
- [ADLL08] S. Alayrangués, X. Daragon, J.-O. Lachaud, and P. Lienhardt. Equivalence between closed connected n -g-maps without multi-incidence and n -surfaces. *J. Math. Imaging Vis.*, 32(1):1–22, 2008.
- [Ago76] M. K. Agoston. *Algebraic Topology, a first course*. Pure and applied mathematics. Marcel Dekker Ed., 1976.
- [APDL09] Sylvie Alayrangués, Samuel Peltier, Guillaume Damiand, and Pascal Lienhardt. Border operator for generalized maps. In Srečko Brlek, Christophe Reutenauer, and Xavier Provençal, editors, *Discrete Geometry for Computer Imagery*, volume 5810 of *Lecture Notes in Computer Science*, pages 300–312. Springer Berlin / Heidelberg, 2009. 10.1007/978-3-642-04397-0_26.
- [Bas10] Tathagata Basak. Combinatorial cell complexes and poincaré duality. *Geometriae Dedicata*, 147:357–387, 2010. 10.1007/s10711-010-9458-y.
- [Bau75] B. Baumgart. A polyhedron representation for computer vision. In *Proc. AFIPS Nat. Conf.*, volume 44, pages 589–596, 1975.
- [BD94] Y. Bertrand and J-F. Dufourd. Algebraic specification of a 3D-Modeler based on hypermaps. *CVGIP: Graphical Models and Image Processing*, 56(1):29–60, January 1994.
- [BDDV03] A. Braquelaire, G. Damiand, J.-P. Domenger, and F. Vidil. Comparison and convergence of two topological models for 3d image segmentation. In *Proceedings of 4th IAPR-TC15 Workshop on*

Graph-Based Representations in Pattern Recognition, volume 2726 of *LNCS*, pages 59–70, York, England, Juillet 2003.

- [BDF00] Y. Bertrand, G. Damiand, and C. Fiorio. Topological encoding of 3d segmented images. In *Proceedings of 9th Discrete Geometry for Computer Imagery*, volume 1953 of *LNCS*, pages 311–324, Uppsala, Sweden, December 13-15 2000.
- [Ber99] G. Bertrand. New notions for discrete topology. In G. Bertrand, M. Couprie, and L. Perroton, editors, *Proc. DGCI'99*, volume 1568 of *Lecture Notes in Computer Science*, pages 218–228, Marne-la-Vallée, France, 1999. Springer.
- [BG88] J.-P. Braquelaire and P. Guitton. A model for image structuration. In *Proc. Computer Graphics International'88*, Genève, Switzerland, May 1988.
- [BK03] L. Brun and W. Kropatsch. Contraction kernels and combinatorial maps. *Pattern Recognition Letters*, 24(8):1051–1057, 2003.
- [Bri89] E. Brisson. Representing geometric structures in d dimensions: topology and order. In *Proc. 5th ACM Symp. Computational Geometry*, pages 218–227, Saarbrücken, Germany, June 1989.
- [Bri93] E. Brisson. Representing geometric structures in d dimensions: topology and order. *Discrete & Computational Geometry*, 9(1):387–426, 1993.
- [BSP⁺05] S. Brandel, S. Schneider, M. Perrin, N. Guiard, Jf Rainaud, P. Lienhardt, and Y. Bertrand. Automatic building of structured geological models. *Journal of Computing and Information Science in Ingeneering*, 5(2), 2005.
- [CCM97] P.R. Cavalcanti, P.C.P. Carvalho, and L.F. Martha. Non-manifold modeling : an approach based on spatial subdivisions. *Computer-Aided Design*, 29(3):299–320, 1997.
- [CMP06] David Cardoze, Gary Miller, and Todd Phillips. Representing topological structures using cell-chains. In Myung-Soo Kim and Kenji Shimada, editors, *Geometric Modeling and Processing - GMP 2006*, volume 4077 of *Lecture Notes in Computer Science*, pages 248–266. Springer Berlin / Heidelberg, 2006. 10.1007/11802914_18.
- [CR91] G. Crocker and W. Reinke. An editable non-manifold boundary representation. *Computer Graphics and Applications*, 11(2), 1991.
- [DBF04] G. Damiand, Y. Bertrand, and C. Fiorio. Topological model for two-dimensional image representation: definition and optimal extraction algorithm. *Computer Vision and Image Understanding*, 93(2):111–154, February 2004.

- [DCB03] X. Daragon, M. Couprie, and G. Bertrand. Discrete frontiers. In I. Nyström, G. Sanniti di Baja, and S. Svensson, editors, *Proc. DGCI'03*, volume 2886 of *Lecture Notes in Computer Science*, pages 236–245, Naples, Italie, 2003. Springer.
- [DCB05] X. Daragon, M. Couprie, and G. Bertrand. Discrete surfaces and frontier orders. *Journal of Mathematical Imaging and Vision*, 23:379–399, 2005.
- [DD08] A. Dupas and G. Damiand. First results for 3d image segmentation with topological map. In *Proceedings of 14th International Conference on Discrete Geometry for Computer Imagery*, volume 4992 of *LNCS*, pages 507–518, Lyon, France, April 2008. Springer.
- [DE95] C. J. A. Delfinado and H. Edelsbrunner. An incremental algorithm for betti numbers of simplicial complexes on the 3-sphere. *Comput. Aided Geom. Design*, 12(7):771–784, 1995.
- [DFMMP03] L. De Floriani, M. Mesmoudi, F. Morando, and E. Puppo. Decomposing non-manifold objects in arbitrary dimensions. *Graphical Models*, 65(1-3):2–22, 2003.
- [DFMP03a] L. De Floriani, F. Morando, and E. Puppo. A representation for abstract simplicial complexes. In I. Nyström, G. Sanniti di Baja, and S. Svensson, editors, *Proc. of DGCI'03*, volume 2886 of *Lecture Notes in Computer Science*, pages 454–464, Naples, Italie, November 2003. Springer.
- [DFMP03b] L. De Floriani, F. Morando, and E. Puppo. Representation of non-manifold objects through decomposition into nearly manifold parts. In V. Shapiro and G. Elber, editors, *8th A.C.M. Symposium on Solid Modeling and Applications*, pages 304–309, Seattle, U.S.A., June 2003. ACM Press.
- [DL89] D. Dobkin and M. Laszlo. Primitives for the manipulation of three-dimensional subdivisions. *Algorithmica*, 5(4):3–32, 1989.
- [DPF08] Guillaume Damiand, Samuel Peltier, and Laurent Fuchs. Computing Homology Generators for Volumes Using Minimal Generalized Maps. In *International Workshop on Combinatorial Image Analysis International Workshop on Combinatorial Image Analysis*, volume 4958 of *LNCS*, pages 63–74, Buffalo, NY États-Unis, 03 2008. Springer-Verlag.
- [DSV01] J. G. Dumas, B.D. Saunders, and G. Villard. On efficient sparse integer matrix smith normal form computations. *J. of Symbolic Computation*, 2001.
- [Ede87] H. Edelsbrunner. *Algorithms in Computational Geometry*. Springer, New-York, 1987.

- [EKM96] A. V. Evako, R. Kopperman, and Y. V. Mukhin. Dimensional properties of graphs and digital spaces. *Journal of Mathematical Imaging and Vision*, 6:109–119, 1996.
- [EL94] H. Elter and P. Lienhardt. Cellular complexes as structured semi-simplicial sets. *International Journal of Shape Modeling*, 1(2):191–217, 1994.
- [ELZ02] Herbert Edelsbrunner, David Letscher, and Afra Zomorodian. Topological persistence and simplification. *Discrete & Computational Geometry*, 28(4):511–533, 2002.
- [FP90] Rudolf Fritsch and Renzo A. Piccinini. *Cellular Structures in Topology*. Cambridge University Press, 1990.
- [GDJMR09] Rocío González-Díaz, María José Jiménez, Belén Medrano, and Pedro Real. Chain homotopies for object topological representations. *Discrete Applied Mathematics*, 157(3):490–499, 2009.
- [Gie96] M. Giesbrecht. Probabilistic computation of the smith normal form of a sparse integer matrix. In *Proceedings of the Second Int. Symp. on Algorithmic Number Theory, LNCS*, volume 1122, pages 173–186. Springer-Verlag, 1996.
- [GP90] Choi Y. Gursoz, E.L. and F.B. Prinz. Vertex-based representation of non-manifolds boundaries. In Turner J. Wozny, M. and K. Preiss, editors, *Geometric Modeling for Product Engineering*, pages 107–130. North-Holland, 1990.
- [GS85] L. Guibas and G. Stolfi. Primitives for the manipulation of general subdivisions and the computation of voronoi diagrams. *Transactions on Graphics*, 4(2):74–123, 1985.
- [Hat02] A. Hatcher. *Algebraic Topology*. Cambridge University Press, 2002.
- [HC93] O.H. Hansen and N.J. Christiansen. A model for n-dimensional boundary topology. In J. Rossignac and J. Turner, editors, *2nd A.C.M. Symposium on Solid Modeling Foundations and CAD/CAM Applications*, pages 65–73, Montréal, Canada, May 1993.
- [KB79] R. Kannan and A. Bachem. Polynomial algorithms for computing the Smith and Hermite normal forms of an integer matrix. *SIAM Journal on Computing*, 8(4):499–507, November 1979.
- [KMM04] T. Kaczynski, K. Mischaikow, and M. Mrozek. *Computational Homology*. Springer, 2004.

- [KMS98] T. Kaczynski, M. Mrozek, and M. Slusarek. Homology computation by reduction of chain complexes. *Computers & Math. Appl.*, 34(4):59–70, 1998.
- [Lie89] P. Lienhardt. Subdivisions of n -dimensional spaces and n -dimensional generalized maps. In *ACM Symposium on Computational Geometry*, pages 228–236, Juin 1989.
- [Lie91] P. Lienhardt. Topological models for boundary representation: a comparison with n -dimensional generalized maps. *Computer Aided Design*, 23(1):59–82, 1991.
- [Lie94] P. Lienhardt. N -dimensional generalized combinatorial maps and cellular quasi-manifolds. *International Journal of Computational Geometry and Applications*, 4(3):275–324, 1994.
- [LL90] Y. Luo and G.A. Lukacs. A boundary representation for form-features and non-manifold solid objects. In *1st ACM/Siggraph Symposium on Solid Modeling Foundations and CAD/CAM Applications*, Austin, Texas, U.S.A., 1990.
- [LL96] V. Lang and P. Lienhardt. Simplicial sets and triangular patches. In *Proceedings of CGI'96*, Pohang, Korea, 1996.
- [LL01] S.H. Lee and K. Lee. Partial entity structure : a fast and compact non-manifold boundary representation based on partial topological entities. In *6th A.C.M. Symposium on Solid Modeling and Applications*, Ann Arbor, U.S.A., 2001.
- [LPR93] C.N. Lee, T. Poston, and A. Rosenfeld. Holes and Genus of 2D and 3D Digital Images. *CVGIP: Graphical Models and Image Processing*, 55(1):20–47, January 1993.
- [M88] M. Mäntylä. *An Introduction to Solid Modeling*. Computer Science Press,, 1988.
- [May67] J. P. May. *Simplicial objects in algebraic topology*. Van Nostrand, Princeton, 1967.
- [MH90] S. Murabata and M. Higashi. Non-manifold geometric modeling for set operations and surface operations. In *Proc. IFIP/RPI Geometric Modeling Conference*, Rensselaerville, N.Y., 1990.
- [MK05] H. Meine and U. Köthe. The geomap : a unified representation for topology and geometry. In L. Brun and M. Vento, editors, *Proc. IAPR Graph-based representations in pattern recognition*, volume 3434 of *Lecture Notes in Computer Science*, Poitiers, France, April 2005.

- [Mun30] J. R. Munkres. *Elements of Algebraic Topology*. Addison Wesley Publisher Company, 1930.
- [NSK⁺02] M. Niethammer, A.N. Stein, W.D. Kalies, P. Pilarczyk, K. Mischaikow, and A. Tannenbaum. Analysis of blood vessel topology by cubical homology. In *IEEE Proceedings of the International Conference on Image Processing*, volume 2, pages 969–972, 2002.
- [PAFL06a] S. Peltier, S. Alayrangues, L. Fuchs, and J.-O. Lachaud. Computation of homology groups and generators. *Comput. & Graph.*, 30:62–69, feb. 2006.
- [PAFL06b] Samuel Peltier, Sylvie Alayrangues, Laurent Fuchs, and Jacques-Olivier Lachaud. Computation of Homology Groups and Generators. *computer & graphics*, 30:62–69, 02 2006.
- [PBCF93] A. Paoluzzi, F. Bernardini, C. Cattani, and V. Ferrucci. Dimension-independent modeling with simplicial complexes. *A.C.M. Transactions on Graphics*, 12(1):56–102, 1993.
- [PFL09] S. Peltier, L. Fuchs, and P. Lienhardt. Simplicial sets: Definitions, operations and comparison with simplicial sets. *Discrete App. Math.*, 157:542–557, feb. 2009.
- [PFP95] V. Pascucci, V. Ferrucci, and A. Paoluzzi. Dimension-independent convex-cell based hierarchical polyhedral complex : representation scheme and implementation issues. In *3rd Symposium on Solid Modeling and Applications*, pages 163–174, 1995.
- [PIK⁺09] Samuel Peltier, Adrian Ion, Walter G. Kropatsch, Guillaume Damiand, and Yll Haxhimusa. Directly Computing the Generators of Image Homology using Graph Pyramids. *Image and Vision Computing*, 27(7):846–853, 06 2009.
- [RO89] J. Rossignac and M. O’Connor. Sgc : A dimension-independent model for pointsets with internal structures and incomplete boundaries. *Geometric modeling for Product Engineering*, pages 145–180, 1989.
- [Sob89] C. Sobhanpanah. Extension of a boundary representation technique for the description of n-dimensional polytopes. *Computer and Graphics*, 13(1):17–23, 1989.
- [Spe91] J.-C. Spohner. Merging in maps and pavings. *Theoretical Computer Science*, 86:205–232, 1991.
- [Sto96] A. Storjohann. Near optimal algorithms for computing smith normal forms of integer matrices. In Y. N. Lakshman, editor, *Proceedings of the 1996 International Symposium on Symbolic and Algebraic Computation*, pages 267–274. ACM, 1996.

- [VD03] F. Vidil and G. Damiand. Moka. <http://moka-modeller.sourceforge.net/>, 2003.
- [Vin83] A. Vince. Combinatorial maps. *Journal of Combinatorial Theory Series B*, 34:1–21, 1983.
- [VL07] Éric Colin De Verdière and Francis Lazarus. Optimal pants decompositions and shortest homotopic cycles on an orientable surface. *J. ACM*, 54, July 2007.
- [Wei85] K. Weiler. Edge-based data structures for solid modelling in curved-surface environments. *Computer Graphics and Applications*, 5(1):21–40, 1985.
- [Wei86] K. Weiler. The radial-edge data structure: A topological representation for non-manifold geometry boundary modeling. In *Proc. IFIP WG 5.2 Working Conference*, Rensselaerville, U.S.A., 1986.
- [ZC08] Afra Zomorodian and Gunnar Carlsson. Localized homology. *Computational Geometry*, 41(3):126 – 148, 2008.