



**HAL**  
open science

# Diesel Oxidation Catalyst Combined to Non-Thermal Plasma: Effect on Activation Catalyst Temperature and by-products formation

Alexis Leray, Ahmed Khacef, Maxime Makarov, Jean Marie Cormier

► **To cite this version:**

Alexis Leray, Ahmed Khacef, Maxime Makarov, Jean Marie Cormier. Diesel Oxidation Catalyst Combined to Non-Thermal Plasma: Effect on Activation Catalyst Temperature and by-products formation. 20th International Symposium on Plasma Chemistry, Jul 2011, Philadelphia, United States. pp.1-4. hal-00680790v1

**HAL Id: hal-00680790**

**<https://hal.science/hal-00680790v1>**

Submitted on 20 Mar 2012 (v1), last revised 12 Apr 2012 (v2)

**HAL** is a multi-disciplinary open access archive for the deposit and dissemination of scientific research documents, whether they are published or not. The documents may come from teaching and research institutions in France or abroad, or from public or private research centers.

L'archive ouverte pluridisciplinaire **HAL**, est destinée au dépôt et à la diffusion de documents scientifiques de niveau recherche, publiés ou non, émanant des établissements d'enseignement et de recherche français ou étrangers, des laboratoires publics ou privés.

# Diesel Oxidation Catalyst Combined to Non-Thermal Plasma: Effect on Activation Catalyst Temperature and by-products formation

A. Leray<sup>1,2</sup>, A. Khacef<sup>1</sup>, M. Makarov<sup>2</sup>, J.M. Cormier<sup>1</sup>

<sup>1</sup>GREMI, PolyTech'Orléans, 14 rue d'Issoudun, BP 6744, 45067 Orléans Cedex 02, France

<sup>2</sup>RENAULT S.A.S, Technocentre, 1 avenue du Golf, 78288 Guyancourt, France

**Abstract:** The aim of this work is to study the pollutants removal efficiency together with the catalyst activation temperature when a Diesel Oxidation Catalyst (DOC) is placed downstream to a multi-plans Dielectric Barrier Discharge (DBD) reactor. In order to simulate Diesel engine exhaust, synthetic gas mixtures containing N<sub>2</sub>, O<sub>2</sub>, H<sub>2</sub>O, CO<sub>2</sub>, CO, NO, and hydrocarbons (HCs) at controlled concentrations could be heated at temperature up to 300°C. Catalytic material based on Pd and Pt supported on Al<sub>2</sub>O<sub>3</sub> was used at a gas hourly space velocities (GHSV) of about 55 000 h<sup>-1</sup>. The major gaseous components as NO<sub>x</sub>, CO, CO<sub>2</sub>, and HCs were systematically investigated online and quantified using an electrochemical analyzer and a Fourier Transform Infrared Absorption Spectroscopy (FTIR). Results show the advantageous plasma catalyst coupling effect on the lowering of the catalyst activation temperature. Improvement of about 20°C was obtained. As it is well known, the gas-phase chemistry in the plasma includes NO to NO<sub>2</sub> conversion as well as HCs partial oxidation to C<sub>x</sub>H<sub>y</sub>O<sub>z</sub>. These species play an important role in the catalytic mechanisms. By-products such as aldehydes (CH<sub>2</sub>O) and alcohols (CH<sub>3</sub>OH) compounds were also detected together with a small amount of nitrous acid (HONO) when water was added into the gas mixture.

**Keywords:** DBD, catalyst, exhaust gas, post-treatment, Diesel

## 1. Introduction

Increasingly stringent air quality standards will require future car engines to be equipped with exhaust aftertreatment systems capable of decreasing the emission of unburned hydrocarbons (UHCs), carbon monoxide (CO), nitrogen oxides (NO<sub>x</sub>) and sulfur oxides (SO<sub>x</sub>) in an oxidizing environment where the traditional three-way catalysts cannot work. Until now, no stable and sufficiently active catalyst for selective catalytic reduction (SCR) of emissions from automotive exhaust gases under lean-burn conditions (i.e. oxygen rich) and low temperature has been designed yet [1, 2]. The excess of oxygen makes lean NO<sub>x</sub> catalytic processing inefficient and fraught with limitations such as temperature windows and sulfur poisoning [1].

Among several approaches under development in the last decade, the research efforts are focusing on finding a catalyst that can be combined with non-

thermal plasma (NTP) to reduce pollutants from lean exhausts especially for Diesel exhaust [3]. In that field, dielectric barrier (DBD) and corona discharges in conjunction with number of materials having catalyst activity for NO<sub>x</sub> reduction in lean exhaust have been studied extensively [4, 5]. To be effective, this technology should improve pollutant conversion efficiencies and lower catalyst light-off temperature.

This paper focuses on the gas treatment efficiency together with the catalyst activation temperature when a Diesel Oxidation Catalyst (DOC) is placed downstream to DBD reactor.

## 2. Experimental part

The experimental arrangement is shown schematically in figure 1 and consists of a gas manifold, a heating line, a plasma-catalyst system and gas analyzers.

Gas mixtures were prepared in a gas handling

system including calibrated high precision mass flow controllers. The goal is to reach synthetic gas mixture simulating Diesel exhaust (10% O<sub>2</sub>, 4% CO<sub>2</sub>, 4% H<sub>2</sub>O, 8500 ppm CO, 1500 ppmC HCs, 100 ppm NO, N<sub>2</sub> as balance). Water vapor with controlled concentrations was added to the gas mixture using controlled evaporator mixer CEM<sup>®</sup>. After mixing in the manifold, the gas mixture passes through a temperature controlled line which heats the gas to temperature between 80 and 300°C. The local temperature in the plasma reactor is higher than the gas temperature measured at the outlet of the system (figure 1).

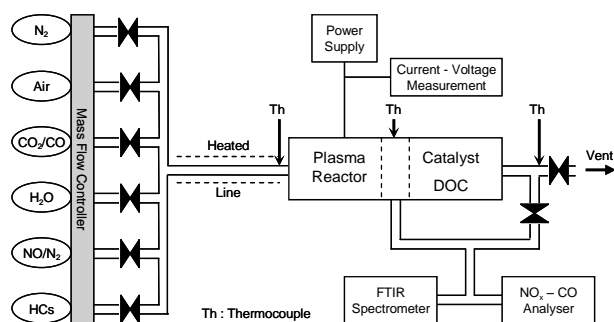

**Figure 1:** Schematic diagram of the experimental set-up.

The plasma reactor we used is multi-DBDs reactor in planar geometry (HK-MnS Co. Ltd, Korea). Each elementary part consists of a pair of alumina plates coated with thin metal layer (electrodes gap of about 1.5 mm). The plasma reactor was powered by a high voltage, high frequency AC generator (11 kV-20 kHz). An example of the plasma discharges in air is shown in figure 2.

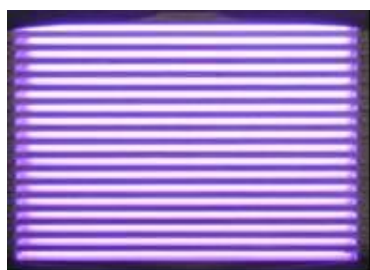

**Figure 2:** Photography of the plasma discharges in air.

The applied voltage and the current were measured using a high voltage probe (Tektronix P6015A) and current probe (Pearson 4001), respectively. The output signals were transmitted to a digitizing oscilloscope (Tektronix DPO 3054).

Commercial Diesel oxidation catalyst (Pt/Pd/Al<sub>2</sub>O<sub>3</sub>)

in monolith form is placed downstream to the plasma reactor. The catalyst was aged and calcined in a N<sub>2</sub> (70%)/O<sub>2</sub> (20%)/H<sub>2</sub>O (10%) flow at 750°C during 5 h at a heating rate of about 10°C.min<sup>-1</sup>. The catalyst gas hourly space velocities (GHSV) was 55 000 h<sup>-1</sup>.

The major gaseous components as O<sub>2</sub>, CO<sub>2</sub>, CO, NO and NO<sub>2</sub> were analyzed using an electrochemical analyzer (MRU – VarioPlus Industrial). HCs and by-products were analyzed by a Fourier Transform Infrared Spectrometer (FTIR, Nicolet Magna 550) equipped with a heated multiple pass 10 m absorption cell. For each FTIR spectrum, 32 scans were collected at 1 cm<sup>-1</sup> resolution.

All the experiments described in this paper were performed in simulated Diesel exhaust of composition described previously at a plasma specific input energy (SIE) of about 545 J.L<sup>-1</sup> and at room temperature and atmospheric pressure.

### 3. Results and discussion

#### 3.1. Plasma

Figure 3 illustrate the dependence of the NO and NO<sub>2</sub> concentrations on the gas temperature in plasma without catalyst. The plasma reactor partially oxidized NO to NO<sub>2</sub> for gas temperature less than 118°C. In fact, until 118°C, NO<sub>2</sub> concentration rises up from 0 to 163 ppm when NO decrease from 75 to 50 ppm. This oxidation dominant process is replaced by NO<sub>2</sub> to NO reduction reaction as the temperature increased.

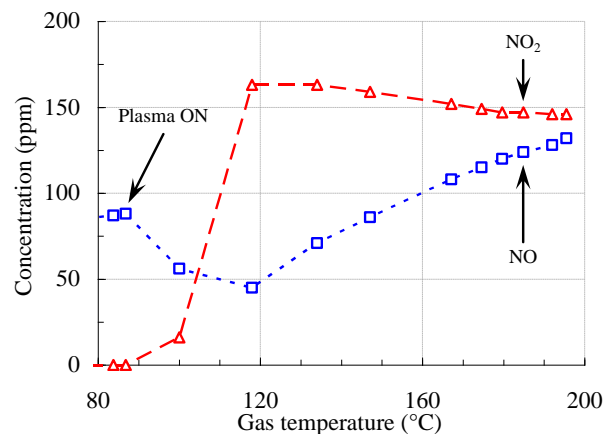

**Figure 3:** Effect of the gas temperature on NO/ NO<sub>2</sub> concentration.

Under oxygen-rich conditions (10%), a fraction of input plasma energy is dissipated in the dissociation

of  $O_2$  which become the dominant process in the production of O radicals. This is due to the fact that the rate of producing O is higher compared to N because of the lower dissociation energy of  $O_2$  (5.2 eV/molecule) compared to  $N_2$  (9.8 eV/molecule). Hydrocarbons, often present in the Diesel exhausts, significantly influence  $NO_x$  chemistry during the plasma remediation by oxidizing NO to  $NO_2$ . Globally, the atomic oxygen produced in the discharge is the initiator of the hydrocarbon chemistry which leads to the production of hydrocarbon radical intermediates such as  $RO_2$ , OH, and  $HO_2$ . After the initiation of the kinetic, the  $HO_2$  radicals and to a lesser extend peroxy,  $RO_2$ , radicals are responsible for the oxidation of NO to  $NO_2$  [1, 2] following reaction 1 and 2. The RO radicals then go on to produce aldehydes.

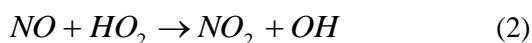
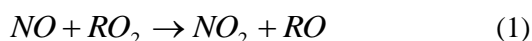

As expected, the plasma partially oxidizes the hydrocarbons. This partial oxidation processes lead to the formation of aldehyde ( $CH_2O$ ), alcohol ( $CH_4O$ ), and a large variety of by-product, such as  $RNO_x$  ( $CH_3NO_3$ ) and nitrous acid ( $HNO_2$ ) as shown in figure 4. The formation of acids, which is minimized in presence of HCs, is due to the OH radicals produced from the  $H_2O$  dissociation by the plasma.

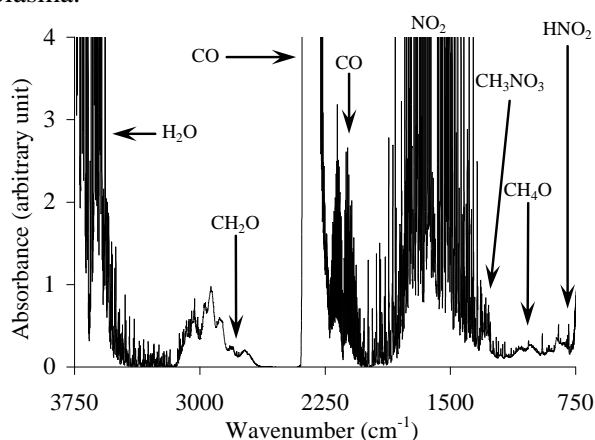

**Figure 4:** FTIR spectrum produced by plasma processing of synthetic Diesel exhaust.

Figure 5 give hydrocarbon infrared absorption spectra, ranging from 2600 to 3200  $cm^{-1}$ , showing the effect of the input energy density on the

hydrocarbon removal efficiency. The HC efficiency removal increases as the input energy density increased.

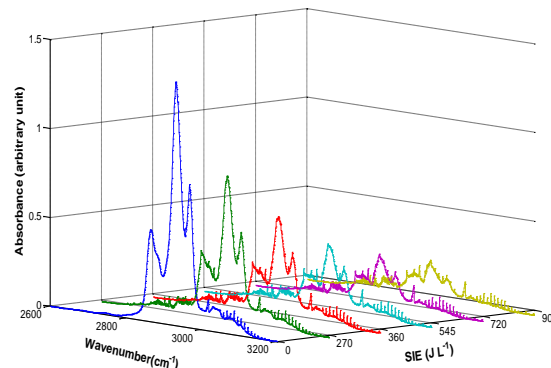

**Figure 5:** Typical FTIR spectra representing the HCs bands as a function of SIE (gas mixture without  $H_2O$ ).

### 3.2. Catalyst and plasma-catalyst

The catalytic activity is expressed in terms of temperature and the catalyst light-off temperature is defined as the temperature at which a catalytic converter achieves a 50% conversion of specific specie (CO, HC ...). Figure 6 shows CO conversion rate as a function of gas temperature for catalyst only (without plasma reactor) and for plasma-catalyst system.

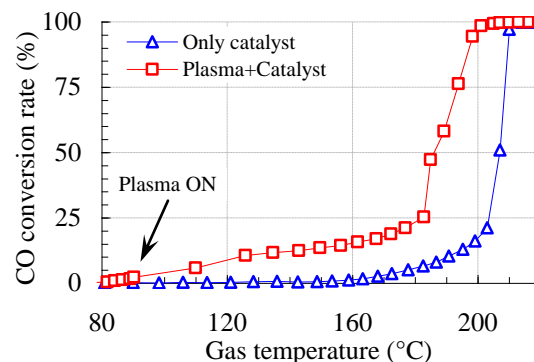

**Figure 6:** Effect of plasma on the light-off temperature of Diesel oxidation catalyst.  $SIE = 545 J L^{-1}$ .

For the "only catalyst" experiments, the catalyst start to be activated at temperature of about  $165^\circ C$  (no CO oxidation before  $165^\circ C$ ) and the light-off temperature of the catalyst is about  $207^\circ C$ .

For plasma-catalyst system, CO oxidation starts as soon as the plasma starts and increases linearly until  $183^\circ C$  leading to the activation of the catalyst at this temperature. In these plasma conditions ( $SIE = 545 J.L^{-1}$ ) and despite the additional gas heating due to the plasma reactor itself, the catalyst

light-off temperature decrease to 185°C. Compared to experiment with only catalyst, an improvement of the catalyst light-off temperature of about 22°C is reached. CO is completely removed at gas temperature of about 205°C.

Figure 7 show the gas temperature dependence of NO and NO<sub>2</sub> concentrations for "only catalyst" and plasma-catalyst systems. In the "only catalyst" experiments, NO to NO<sub>2</sub> oxidation appear at temperature higher than 203°C showing the activation of the catalyst.

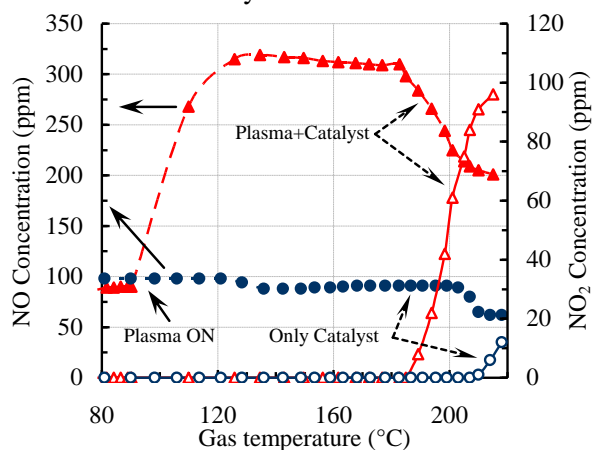
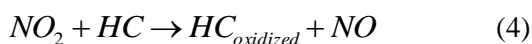
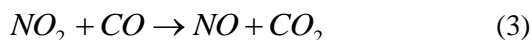

Figure 7: Effect of DOC on the conversion of NO<sub>x</sub>.

When the plasma was combined to the catalyst, NO concentration was significantly affected as the temperature increase, passing from 80 ppm at 80°C to 330 ppm at 189°C and NO<sub>2</sub> concentration remain at zero level. At gas temperature above 189°C, the catalyst is activated and NO<sub>2</sub> appears. Figure 7 confirms as well the decreasing of the catalyst activation temperature.

After the activation of the catalytic oxidation, CO is oxidized by O<sub>2</sub> on the active site of the catalyst. According to Raux et al [6], NO<sub>2</sub> plays a major role in CO abatement before the catalyst activation. NO<sub>2</sub> produced by the plasma discharge can react with CO and/or HCs at the surface of the catalyst through the reactions:



#### 4. Summary

The treatment of synthetic gas mixture (N<sub>2</sub>, O<sub>2</sub>, H<sub>2</sub>O, CO<sub>2</sub>, CO, NO, and HCs) simulating Diesel vehicle exhaust was performed in "only catalyst" and

plasma-catalyst system. Diesel oxidation catalyst (Pt/Pd/Al<sub>2</sub>O<sub>3</sub>) was placed downstream to a multi-DBDs reactor.

In this configuration, the catalyst light-off temperature was improved by about 22°C. By-products created by the plasma reactor (aldehyde, alcohol, nitrous acid, RNO<sub>x</sub>) was identified by FTIR. Moreover, NO<sub>2</sub> plays a role in the oxidation of CO before the activation of the catalyst.

Decreasing the catalyst light-off temperature can improve the pollutant emission efficiency at cold-start. Results presented here were obtained in laboratory conditions. The next step is to use the plasma reactor in real vehicle exhaust conditions.

#### Acknowledgments

This study was supported by national French CIFRE program with a financial support of Renault SA Company. The authors gratefully appreciate the technical assistance of G. Coudrat and acknowledge the support and the discussions with Kim Yone-Seung, Baek Sung-Joon, and their plasma group of HK-MnS Company Ltd (Korea).

#### References

- [1] B.M. Penetrante, R.M. Brusasco, B.T. Merritt, W.J. Pitz, G.E. Voglin, M.C. Kung, H.H. Kung, C.Z. Wan and K.E. Voss, *SAE Technical Paper*, No 982508, (1998)
- [2] B.M. Penetrante, W.J. Pitz, M.C. Hsiao, B.T. Merritt, G.E. Voglin, *Proceeding of the 1997 Diesel Engine Emissions Reduction Workshop*, (1997)
- [3] J.O. Chae, *Journal of Electrostatics*, 57, 251-262, (2003)
- [4] "Non-Thermal Plasma for Exhaust Emission Control", M.L. Balmer, G. Fisher and J. Hoard Eds, *SAE Special Publication*, SP 1483, (1999)
- [5] "Non-Thermal Plasma", M.L. Balmer, G. Fisher and J. Hoard Eds, *SAE Special Publication*, SP 1566, (2000)
- [6] S. Raux, A. Frobert and E. Jeudy, *Top Cata*, 52, 1903-1908, (2009).