



**HAL**  
open science

# Maximum Size of a Minimum Watching System and the Graphs Achieving the Bound

David Auger, Irène Charon, Olivier Hudry, Antoine Lobstein

► **To cite this version:**

David Auger, Irène Charon, Olivier Hudry, Antoine Lobstein. Maximum Size of a Minimum Watching System and the Graphs Achieving the Bound. 2012. hal-00680690

**HAL Id: hal-00680690**

**<https://hal.science/hal-00680690>**

Preprint submitted on 19 Mar 2012

**HAL** is a multi-disciplinary open access archive for the deposit and dissemination of scientific research documents, whether they are published or not. The documents may come from teaching and research institutions in France or abroad, or from public or private research centers.

L'archive ouverte pluridisciplinaire **HAL**, est destinée au dépôt et à la diffusion de documents scientifiques de niveau recherche, publiés ou non, émanant des établissements d'enseignement et de recherche français ou étrangers, des laboratoires publics ou privés.

# Maximum Size of a Minimum Watching System and the Graphs Achieving the Bound

David Auger\*, Irène Charon\*,  
Olivier Hudry\*, Antoine Lobstein†

{*david.auger, irene.charon, olivier.hudry, antoine.lobstein*}@telecom-paristech.fr

February 1, 2012

**Abstract** Let  $G = (V(G), E(G))$  be an undirected graph. A watcher  $w$  of  $G$  is a couple  $w = (\ell(w), A(w))$ , where  $\ell(w)$  belongs to  $V(G)$  and  $A(w)$  is a set of vertices of  $G$  at distance 0 or 1 from  $\ell(w)$ . If a vertex  $v$  belongs to  $A(w)$ , we say that  $v$  is covered by  $w$ . Two vertices  $v_1$  and  $v_2$  in  $G$  are said to be separated by a set of watchers if the list of the watchers covering  $v_1$  is different from that of  $v_2$ . We say that a set  $W$  of watchers is a watching system for  $G$  if every vertex  $v$  is covered by at least one  $w \in W$ , and every two vertices  $v_1, v_2$  are separated by  $W$ . The minimum number of watchers necessary to watch  $G$  is denoted by  $w(G)$ . We give an upper bound on  $w(G)$  for connected graphs of order  $n$  and characterize the trees attaining this bound, before studying the more complicated characterization of the connected graphs attaining this bound.

**Key-words:** Graph Theory, Watching Systems, Identifying Codes

2010 Mathematics Subject Classification: Primary: 05C; Secondary: 05C05, 05C12, 05C35, 05C69.

---

\*Institut Télécom - Télécom ParisTech & Centre National de la Recherche Scientifique - LTCI UMR 5141, 46, rue Barrault, 75634 Paris Cedex 13 - France

†Centre National de la Recherche Scientifique - LTCI UMR 5141 & Institut Télécom - Télécom ParisTech, 46, rue Barrault, 75634 Paris Cedex 13 - France

# 1 Introduction

Let  $G = (V(G), E(G))$  be an undirected connected graph (the case of an unconnected graph can also be treated, by considering separately its connected components). A *watcher*  $w$  of  $G$  is a couple  $w = (\ell(w), A(w))$ , where  $\ell(w)$  belongs to  $V(G)$  and  $A(w)$  is a set of vertices of  $G$  at distance 0 or 1 from  $\ell(w)$ ; in other words,  $A(w)$  is a subset of  $B(\ell(w))$ , the ball of radius 1 centred at  $\ell(w)$ . We will say that  $w$  is *located* at  $\ell(w)$  and that  $A(w)$  is its *watching area* or *watching zone*. If a vertex  $v$  belongs to  $A(w)$ , we say that  $v$  is *covered* by  $w$ .

Two vertices  $v_1$  and  $v_2$  in  $G$  are said to be *separated* by a set of watchers if the list of the watchers covering  $v_1$  is different from that of  $v_2$ .

We say that  $G$  is *watched* by a set  $W$  of watchers, or that  $W$  is a *watching system* for  $G$  if:

- for every  $v$  in  $V(G)$ , there exists  $w \in W$  such that  $v$  is covered by  $w$ ;
- if  $v_1$  and  $v_2$  are two vertices of  $G$ ,  $v_1$  and  $v_2$  are separated by  $W$ .

Note that several watchers can be located at a same vertex, and a watcher does not necessarily cover the vertex where it is located.

The minimum number of watchers necessary to watch a graph  $G$  is denoted by  $w(G)$ .

We will often represent watchers simply by integers, as for the graph  $G_0$ , which has 8 vertices, represented in Figure 1: the location of a watcher is written inside a rectangle; for each vertex  $v$  of the graph, the list of watchers covering  $v$  is written in italics, so that the watching area of each watcher can be retrieved. In the example of Figure 1, the watcher 1 is located at  $c$  and covers the vertices  $a$ ,  $c$  and  $d$ , the watcher 2 is also located at  $c$  and covers the vertices  $b$ ,  $c$  and  $e$ , the watcher 3 is located at  $f$  and covers the vertices  $d$ ,  $e$ ,  $f$  and  $h$ , and the watcher 4 is located at  $e$  and covers the vertices  $f$  and  $g$ . The graph  $G_0$  is watched by these four watchers and, using inequality (1) below, we have that  $w(G_0) = 4$ .

Let  $G$  be a graph of order  $n$ . If we have a set  $W$  of  $k$  watchers, the number of distinct non empty subsets of  $W$  is equal to  $2^k - 1$ . Therefore, it is necessary to have  $2^k - 1 \geq n$ , and so we have the inequality:

$$w(G) \geq \lceil \log_2(n + 1) \rceil. \tag{1}$$

Obviously, watching systems generalize *identifying codes* (see the seminal paper [8], and [9] for a large bibliography): indeed, identifying codes are

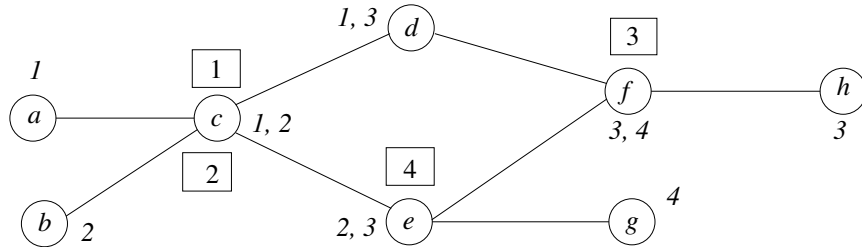

Figure 1: a graph  $G_0$  watched by the watchers 1, 2, 3 and 4

such that for any  $w = (\ell(w), A(w)) \in W$ , we have

$$A(w) = B(\ell(w)),$$

which means that, in this case, a watcher, or *codeword*, necessarily covers itself and all its neighbours.

See also [7], [10] for similar ideas.

Watching systems were introduced in [1] and [2], where motivations are exposed at large, basic properties are given, a complexity result is established, and the case of the paths and cycles is studied in detail, with comparison to identifying codes.

In Section 2, we give an upper bound on  $w(G)$  when  $G$  is a connected graph with  $n$  vertices. In Section 3, we characterize the trees of order  $n$  which attain this bound: Theorems 7, 12 and 13 are for the cases  $n = 3k$ ,  $n = 3k + 2$  and  $n = 3k + 1$ , respectively. This helps to study, in Section 4, the characterization of *maximal* graphs reaching the bound, that is, graphs to which no edge can be added without decreasing the minimum number of necessary watchers: Theorems 15 and 16 give the answer for  $n = 3k$  and  $n = 3k + 2$  respectively, and Proposition 17 and Conjecture 18 are stated for the case  $n = 3k + 1$ . This in turn gives results for all the connected graphs attaining the bound.

## 2 The maximum of minimum number of watchers

The following three easy lemmata will prove efficient. We recall that  $H = (V(H), E(H))$  is a partial graph of  $G = (V(G), E(G))$  if  $V(H) = V(G)$  and  $E(H) \subseteq E(G)$ .

**Lemma 1** *Let  $G$  be a graph and  $H$  be a partial graph of  $G$ . Then*

$$w(H) \geq w(G).$$

**Proof.** If  $H$  is watched by a set  $W$  of watchers, the same set  $W$  watches  $G$ , since two adjacent vertices in  $H$  are also adjacent in  $G$ .  $\square$

Note that this monotonicity property does not hold in general for identifying codes.

**Lemma 2** *Let  $T$  be a tree,  $x$  be a leaf of  $T$ , and  $y$  be the neighbour of  $x$ .*

(a) *There exists a minimum watching system for  $T$  with one watcher located at  $y$ .*

(b) *If  $y$  has degree 2, there exists a minimum watching system for  $T$  with one watcher located at  $z$ , the second neighbour of  $y$ .*

**Proof.** (a) A watching system must cover  $x$ , so there is a watcher  $w_1$  located at  $x$  or  $y$ , with  $x \in A(w_1)$ . If  $w_1 = (x, A(w_1))$ , then we can replace it by  $w_2 = (y, A(w_1))$ , since  $B_1(y) \supseteq B_1(x)$ .

(b) If, in a watching system of  $T$ , there is no watcher(s) located at  $z$ , then there are at least two watchers whose locations are in the set  $\{x, y\}$ . In the best case, these watchers cover  $x$ ,  $y$  and  $z$ , and separate them pairwise. This task can just as well be done by two watchers located at  $y$  and  $z$ .  $\square$

**Lemma 3** *Let  $T$  be a tree of order 4 and let  $v$  be a vertex of  $T$ ; there exists a set  $W$  of two watchers such that*

- *the vertices in  $V(T) \setminus \{v\}$  are covered and pairwise separated by  $W$  — in this case, we shall say, with a slight abuse of notation, that  $V(T) \setminus \{v\}$  is watched by  $W$ ;*
- *the vertex  $v$  is covered by at least one watcher.*

**Proof.** On Figure 2, we give all possibilities: the two trees of order 4, and for each of them, the two locations for  $v$  ( $v$  is a leaf, or  $v$  is not a leaf).  $\square$

We are now ready to give an upper bound for  $w(G)$  with respect to  $n$ , the order of  $G$ . Note in contrast that the upper bound for identifying codes, when they exist, is  $n - 1$ , see [3], [6], and is reached, among other graphs, by the star; see also [4] and [5].

**Theorem 4** *Let  $G$  be a connected graph of order  $n$ .*

- *If  $n = 1$ ,  $w(G) = 1$ .*

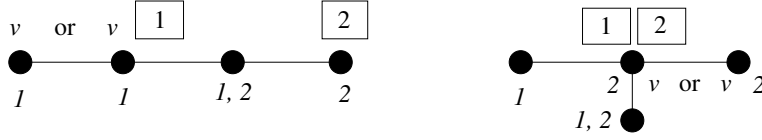

Figure 2: trees of order 4

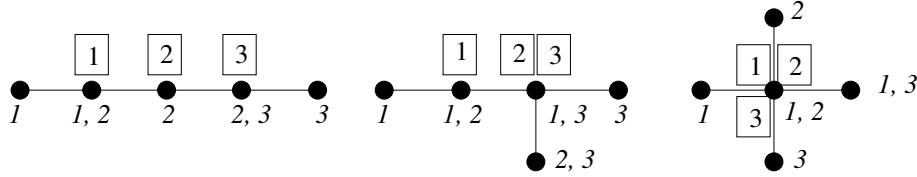

Figure 3: the case  $n=5$  in Theorem 4

- If  $n = 2$  or  $n = 3$ ,  $w(G) = 2$ .
- If  $n = 4$  or  $n = 5$ ,  $w(G) = 3$ .
- If  $n \notin \{1, 2, 4\}$ ,  $w(G) \leq \frac{2n}{3}$ .

The proof can be found in [1], [2], but we give it here, because the results of the four cases into which it is divided will be frequently used in the sequel.

**Proof.** For  $n = 1$ ,  $n = 2$ , or  $n = 3$ , the result is direct. For  $n = 4$ , it is necessary to have at least  $\lceil \log_2(5) \rceil = 3$  watchers and it is easy to verify that this is sufficient. For  $n = 5$ , all possibilities are given by Figure 3 and we can see that we always have  $w(G) = 3$ .

We proceed by induction on  $n$ . We assume that  $n \geq 6$  and that the theorem is true for any connected graph of order less than  $n$ .

Let  $G$  be a connected graph of order  $n$ . Let  $T$  be a spanning tree of  $G$ ; we will prove that  $w(T) \leq \frac{2n}{3}$  and then the theorem will result from Lemma 1. We denote by  $D$  the diameter of  $T$  (i.e., the maximum distance between two distinct vertices of  $T$ ) and we consider a path  $v_0, v_1, v_2, \dots, v_{D-1}, v_D$  of  $T$ , with  $D$  edges.

We distinguish between four cases, according to some conditions on the degrees of  $v_{D-1}$  and  $v_{D-2}$ .

- *First case: the degree of  $v_{D-1}$  is equal to 3*  
The vertex  $v_{D-1}$  is adjacent to a vertex  $x$  other than  $v_{D-2}$  and  $v_D$ ; because

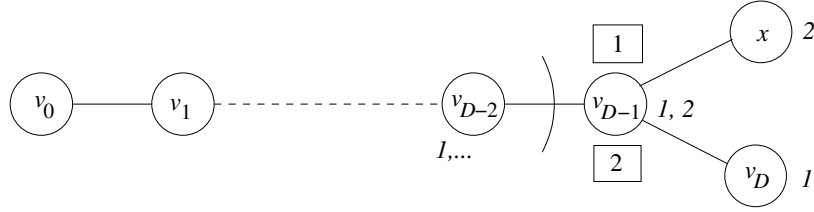

Figure 4: first case of Theorem 4: the degree of  $v_{D-1}$  is equal to 3

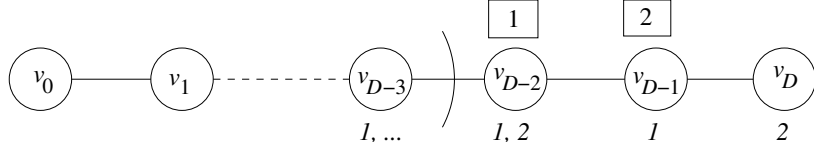

Figure 5: second case of Theorem 4: the degrees of  $v_{D-1}$  and  $v_{D-2}$  are equal to 2

$D$  is the diameter, clearly  $x$  and  $v_D$  are leaves of  $T$  (see Figure 4). We consider the tree obtained by removing  $x$ ,  $v_{D-1}$  and  $v_D$  from  $T$ ; this new tree  $T'$  has order  $n - 3$ .

If  $n \geq 8$  or if  $n = 6$ , we consider a minimum set  $W$  of watchers watching  $T'$ ; if  $n = 7$ , then  $T'$  is of order 4, and, using Lemma 3, we choose a set  $W$  of two watchers to watch  $V(T') \setminus \{v_{D-2}\}$  and cover the vertex  $v_{D-2}$ .

Then for  $T$ , in both cases, we add to  $W$  two watchers  $w_1 = (v_{D-1}, \{v_{D-2}, v_{D-1}, v_D\})$  and  $w_2 = (v_{D-1}, \{v_{D-1}, x\})$ . On Figure 4, we rename these watchers 1 and 2. Then  $T$  is watched by  $W \cup \{w_1, w_2\}$ . So,  $w(T) \leq |W| + 2 \leq w(T') + 2$ .

Now we use the induction hypothesis: if  $n \geq 8$  or  $n = 6$ , then  $w(T) \leq \frac{2}{3}(n - 3) + 2 = \frac{2n}{3}$ ; and if  $n = 7$ , then  $w(T) \leq 2 + 2 = 4 < \frac{2}{3} \times 7$ .

• *Second case: the degrees of  $v_{D-1}$  and  $v_{D-2}$  are equal to 2*

The neighbours of  $v_{D-1}$  are  $v_{D-2}$  and  $v_D$ , the neighbours of  $v_{D-2}$  are  $v_{D-3}$  and  $v_{D-1}$  (see Figure 5). We consider the tree obtained by removing  $v_{D-2}$ ,  $v_{D-1}$  and  $v_D$  from  $T$ ; this new tree  $T'$  has order  $n - 3$ .

If  $n \geq 8$  or if  $n = 6$ , we consider a minimum set  $W$  of watchers watching  $T'$ ; if  $n = 7$ ,  $T'$  is of order 4; again using Lemma 3, we choose a set  $W$  of two watchers to watch  $V(T') \setminus \{v_{D-3}\}$  and cover the vertex  $v_{D-3}$ . As in the first case, we add to  $W$  two watchers:  $w_1 = (v_{D-2}, \{v_{D-3}, v_{D-2}, v_{D-1}\})$  and

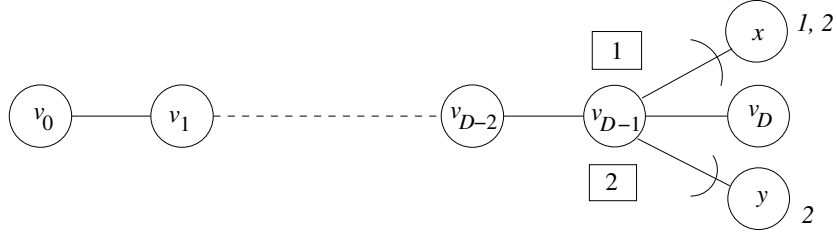

Figure 6: third case of Theorem 4: the degree of  $v_{D-1}$  is at least 4

$w_2 = (v_{D-1}, \{v_{D-2}, v_D\})$ , and  $T$  is watched. So,  $w(T) \leq |W| + 2 \leq w(T') + 2$ . The end of this case is the same as in the first case.

- *Third case: the degree of  $v_{D-1}$  is at least 4*

The vertex  $v_{D-1}$  is adjacent to at least two vertices other than  $v_{D-2}$  and  $v_D$ : let  $x$  and  $y$  be two neighbours of  $v_{D-1}$  distinct from  $v_{D-2}$  and  $v_D$ ; these two vertices are leaves of  $T$  (see Figure 6). We consider the tree  $T'$  obtained by removing  $x$  and  $y$  from  $T$ . By Lemma 2, there exists a minimum set  $W$  of watchers watching  $T'$  with a watcher  $w_1$  located at  $v_{D-1}$ . For  $T$ , we take the set  $W$  and we add the watcher  $w_2 = (v_{D-1}, \{x, y\})$ ; we also add the vertex  $x$  to the watching area of  $w_1$ . Since the tree  $T'$  is watched by  $W$ , the tree  $T$  is watched by  $W \cup \{w_2\}$ . So,  $w(T) \leq w(T') + 1$ .

If  $n \geq 7$ , the order of  $T'$  is at least 5 and, using the induction hypothesis,  $w(T) \leq \frac{2}{3}(n-2) + 1 < \frac{2n}{3}$ .

If  $n = 6$ , then  $n - 2 = 4$  and  $w(T) \leq 3 + 1 = 4 = \frac{2}{3} \times 6$ .

- *Fourth case: the degree of  $v_{D-1}$  is equal to 2 and the degree of  $v_{D-2}$  is at least 3*

The neighbours of  $v_{D-1}$  are  $v_{D-2}$  and  $v_D$ . The vertex  $v_{D-2}$  is adjacent to  $v_{D-3}$  and  $v_{D-1}$  but also to at least one other vertex  $x$  (see Figure 7); if the degree of  $x$  is at least 3, using the fact that the diameter of  $T$  is equal to  $D$ , we can use the first or third case to conclude the claim, with  $x$  playing the part of  $v_{D-1}$ .

So, we assume that the degree of  $x$  is 1 or 2; if its degree is 2, it has a neighbour  $y$  other than  $v_{D-2}$ .

We consider the tree  $T'$  of order  $n - 2$  obtained by removing  $v_{D-1}$  and  $v_D$  from  $T$ . By Lemma 2, there exists a minimum set  $W$  of watchers watching  $T'$  with a watcher  $w_1$  located at  $v_{D-2}$ . To watch  $T$ , we take the set  $W$  and add the watcher  $w_2 = (v_{D-1}, \{v_{D-1}, v_D\})$ ; we also add the vertex  $v_{D-1}$  to the



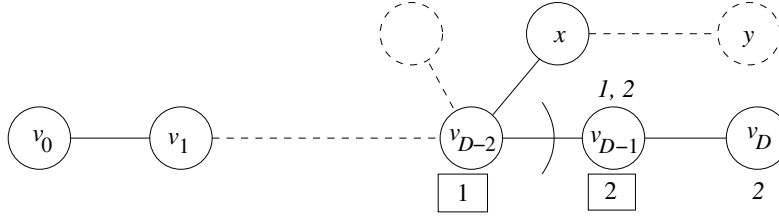

Figure 7: fourth case of Theorem 4: the degree of  $v_{D-1}$  is equal to 2 and the degree of  $v_{D-2}$  is at least 3

watching area of  $w_1$ . Then  $T$  is watched by  $W \cup \{w_2\}$ .

The end of this case is exactly the same as in the previous case.  $\square$

**Remark 5** *In the proof of Theorem 4, we have constructed, according to the cases, a tree  $T'$  with order  $n - 3$  such that  $w(T) \leq w(T') + 2$ , or a tree  $T'$  with order  $n - 2$  such that  $w(T) \leq w(T') + 1$ .*

These two constructions, from  $T$  to  $T'$ , will be used several times in the sequel, e.g., in the proof of Theorem 7.

### 3 Trees $T$ of order $n$ for which $w(T) = \lfloor \frac{2n}{3} \rfloor$

In this section, we characterize the trees  $T$  with  $n$  vertices and  $w(T) = \lfloor \frac{2n}{3} \rfloor$ . Our study is divided into three cases,  $n = 3k$ ,  $n = 3k + 2$  and  $n = 3k + 1$ . Note that the number of isomorphic trees of a given order can be determined: see, e.g., [11, Fig. 4, seq. 299] or [12]. The sequence goes 1, 1, 1, 2, 3, 6, 11, 23, 47, 106, ..., see also Figures 10, 13 and 23.

We first define some particular trees, of order 1 to 5, that we name *gadgets*. For each gadget, we choose one or two particular vertices named *binding vertices*, through which the different gadgets will be exclusively connected between themselves; a vertex which is not a binding vertex is said to be *ordinary*. In the sequel, we will sometimes denote a gadget of order  $i$  by  $g_i$ ,  $1 \leq i \leq 5$ , and use the abbreviation b. v. for binding vertex. The gadgets are depicted in Figure 8; we represent the binding vertices with squares and ordinary vertices with circles.

We will use the following easy lemma, whose proof we omit.

**Lemma 6** *Let  $T$  be a tree of order 3, and  $v$  and  $v'$  be two distinct vertices in  $T$ . It is possible to watch  $T$  with one watcher located at  $v$  and one watcher located at  $v'$ .*

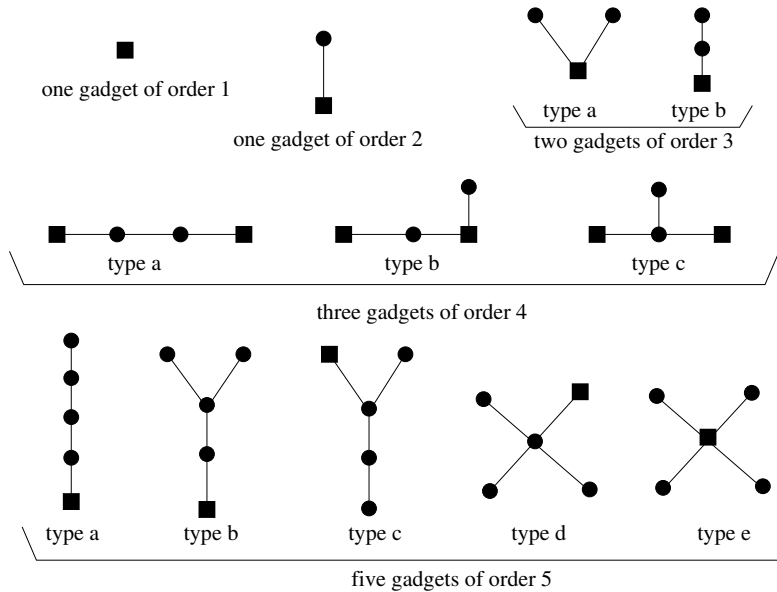

Figure 8: all the gadgets

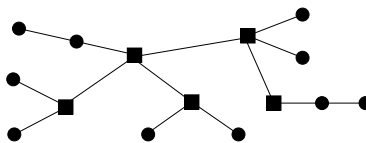

Figure 9: the tree  $T_{15}$

As a consequence, if  $T'$  is a tree of order 4 and  $x$  is a leaf of  $T'$ , there exists a set  $W$  of two watchers such that  $V(T') \setminus \{x\}$  is watched by  $W$  and  $x$  is covered by  $W$ .

The following theorem characterizes the trees  $T$  with order  $n = 3k$  and  $w(T) = 2k$ .

**Theorem 7** Let  $T$  be a tree of order  $n = 3k$  for  $k \geq 1$ . We have:  
 $w(T) = 2k \Leftrightarrow T$  can be obtained by choosing  $k$  gadgets of order 3 and joining these gadgets by their binding vertices to obtain a tree.

The tree  $T_{15}$  in Figure 9 is an example of a tree reaching this maximum.

**Proof.** Assume that a tree  $T$  of order  $n = 3k$  is obtained by choosing  $k$

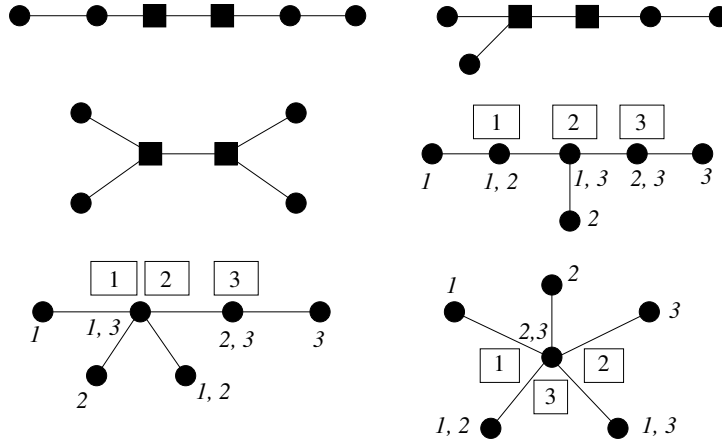

Figure 10: the trees of order 6 for the proof of Theorem 7

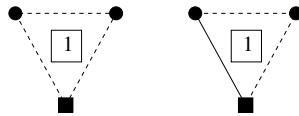

Figure 11: two representations for a g3 of type a or b

gadgets of order 3 and joining these gadgets by their b. v.'s to form a tree. It is clear that, to watch  $T$ , it is necessary to locate two watchers on each gadget. So  $T$  reaches the bound  $2k$ .

We will prove the converse by induction on  $k$ . For  $k = 1$ , it is immediate. We also examine the case  $k = 2$ , that is to say  $n = 6$ . We draw on Figure 10 the six different trees  $T$  on six vertices; when a tree is not of a type described in the right part of the equivalence, we explicitly give the watchers showing that  $w(T) = 3$  and, in the other cases, we simply indicate the b. v.'s of the two gadgets involved.

We will sometimes represent a g3 of type a or b with a triangle, as on Figure 11: a dashed edge means that the edge may exist or not, with always exactly two edges in each g3. A watcher indicated inside the triangle means that this watcher is located at one of the three vertices of the triangle, at an appropriate vertex according to the case.

We assume now that  $k \geq 3$  and that the theorem is true for  $k' < k$ . Let  $T$  be a tree of order  $n = 3k$  with  $w(T) = 2k$ .

We consider again the proof of Theorem 4 using a path  $v_0, v_1, v_2, \dots$ ,

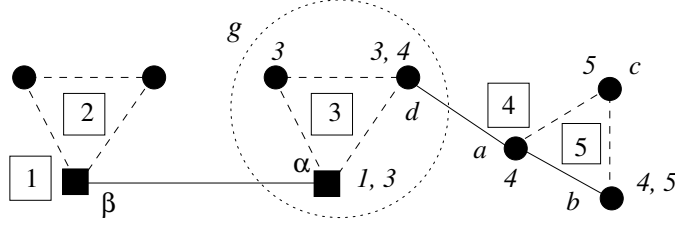

Figure 12:  $2k - 1$  watchers are sufficient in  $T$  (end of proof of Theorem 7)

$v_{D-1}, v_D$  with  $D$  edges, where  $D$  is the diameter of  $T$ . Here, the third and fourth cases are impossible, because they imply that  $w(T) < \frac{2n}{3} = 2k$ , unless  $n = 6$ , which has just been dealt with. In the first case of Theorem 4, we rename the vertices  $v_{D-1}, v_D, x$  and  $v_{D-2}$  by  $a, b, c$  and  $d$ , respectively; in the second case, we rename the vertices  $v_{D-2}, v_{D-1}, v_D$  and  $v_{D-3}$  by  $a, b, c$  and  $d$ , respectively; in both cases, we remove the vertices  $a, b$  and  $c$  from  $T$  and obtain a tree  $T'$  of order  $3(k-1)$ ; by Remark 5, it appears that  $T'$  needs at least  $w(T) - 2 = 2k - 2$  watchers and so  $w(T') = 2(k-1)$  and we can apply the induction hypothesis to  $T'$ : the vertex  $d$  belongs to a  $g_3$ , say  $g$ .

Assume that  $d$  is not the binding vertex of  $g$ . The b. v.  $\alpha$  of  $g$  is adjacent to the b. v.  $\beta$  of another  $g_3$  in  $T'$  (cf. Figure 12). By Lemma 6, we can locate watchers  $w_4$  and  $w_1$  at  $a$  and  $\beta$ , so that  $d$  is covered by  $w_4$  and  $\alpha$  is covered by  $w_1$ ; it is then possible to watch  $T$  with only one watcher located on the gadget  $g$ , as we can see on Figure 12, by choosing the appropriate vertex of  $g$  at which we locate the watcher denoted by 3. This leads to a contradiction on  $w(T)$ , and shows that  $d$  is the b. v. of  $g$ , in which case the result is immediately obtained, since  $\{a, b, c\}$  can be seen as a  $g_3$ , with its b. v. in  $a$ , connected to  $d$ .  $\square$

The following lemmata and definition will be used repeatedly in the sequel.

**Lemma 8** *Let  $T$  be a tree of order 5 and  $v$  be a vertex of  $T$ . It is possible to watch  $T$  with three watchers, one of the three watchers being located at  $v$ .*

*As a consequence, if  $T'$  is a tree of order 6 and  $x$  is a leaf of  $T'$ , there exists a set  $W$  of three watchers such that  $V(T') \setminus \{x\}$  is watched by  $W$  and  $x$  is covered by  $W$ .*

**Proof.** The result for  $T$  is straightforward, by examining all the different possibilities, as we can see on Figure 13; the consequence on  $T'$  is immediate.  $\square$

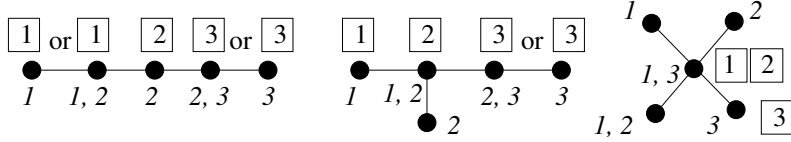

Figure 13: illustration for Lemma 8

**Lemma 9** Consider a  $g5$  with binding vertex  $\alpha$  and ordinary vertices  $v, x, y$  and  $z$ ; there exists a set  $W$  of two watchers such that

- $\{x, y, z\}$  is watched by  $W$ ;
- the vertex  $v$  is covered by  $W$ .

**Proof.** If the  $g5$  is of type a, b, c, or d, then the four vertices  $v, x, y, z$  form a tree, and by Lemma 3, we are done. If the  $g5$  is of type e, then it is also possible, with two watchers located at  $\alpha$ , the centre of the star, to watch  $\{x, y, z\}$  and cover  $v$ .  $\square$

**Definition 10** Let  $H = (V(H), E(H))$  be a connected graph and  $v$  be a vertex in  $V(H)$ ; let  $H'$  be the graph obtained by removing the vertex  $v$  from  $H$  ( $H'$  is connected or not). We say that  $v$  is free of charge, or free, in  $H$  if there exists a minimum watching system for the graph  $H'$  which is also a watching system for  $H$ .

**Lemma 11** Let  $p$  be an integer satisfying  $p \geq 2$ . Let  $F$  be a forest obtained by choosing  $p$  gadgets of order 3 or 5 and possibly, if desired, by adding edges between the binding vertices of the  $p$  gadgets. Let  $v$  be a new vertex, which is adjacent to at least one binding vertex and cannot be adjacent to ordinary vertices; we assume that the graph obtained by adding  $v$  to  $F$  is a tree, say  $T$ . Then, the vertex  $v$  is free in  $T$ .

**Proof.** If  $v$  is adjacent to only one b. v., let  $\alpha$  be this vertex; since  $T$  is connected and  $p \geq 2$ , the vertex  $\alpha$  is adjacent to another b. v., say  $\beta$ . If  $v$  is adjacent to at least two b. v.'s among the  $p$  gadgets, let  $\alpha$  and  $\beta$  be two such vertices. Figure 14 illustrates the lemma in detail in three cases:

- $v$  is linked to the b. v.  $\alpha$  of the  $g5$  of type b and  $\alpha$  is linked to the b. v. of a  $g3$ ;
- $v$  is linked to the b. v.  $\alpha$  of the  $g3$  of type a and  $\alpha$  is linked to the b. v. of a  $g3$ ;
- $v$  is linked to the b. v.'s of the  $g5$  of type b and of a  $g3$ .

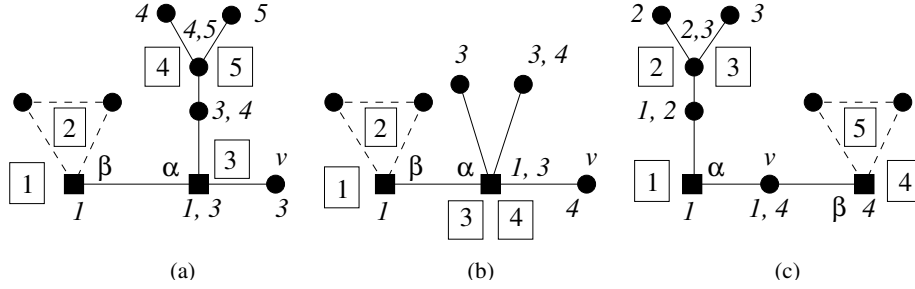

Figure 14: illustration for Lemma 11

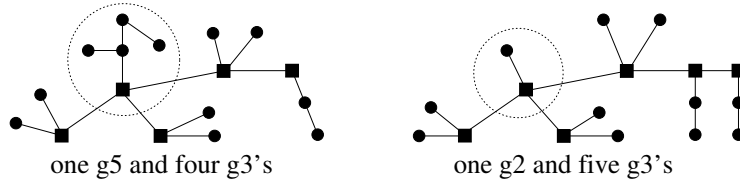

Figure 15: the trees  $T_{17}$  and  $T'_{17}$

After checking all types for the  $g_5$  in (a) and (c) and for the  $g_3$  in (b), one has checked the cases when (a)  $v$  is linked to a  $g_5$  linked to a  $g_3$ ; (b)  $v$  is linked to a  $g_3$  linked to a  $g_3$ ; (c)  $v$  is linked to a  $g_5$  and a  $g_3$ . Using repeatedly Lemmata 6 and 8, the remaining cases can be treated exactly in the same way.  $\square$

We are now ready to characterize the trees  $T$  with order  $n = 3k + 2$  and  $w(T) = 2k + 1$ .

**Theorem 12** *Let  $T$  be a tree of order  $n = 3k + 2$  for  $k \geq 1$ . We have:  $w(T) = 2k + 1 \Leftrightarrow T$  can be obtained by choosing one gadget of order 2 and  $k$  gadgets of order 3, or one gadget of order 5 and  $k - 1$  gadgets of order 3, and joining these gadgets by their binding vertices to obtain a tree.*

The trees  $T_{17}$  and  $T'_{17}$  of Figure 15 are examples of trees which attain this maximum.

**Proof.** Assume that a tree  $T$  of order  $n = 3k + 2$  is obtained by choosing one  $g_2$  and  $k$   $g_3$ 's, or one  $g_5$  and  $k - 1$   $g_3$ 's, and finally joining these gadgets by their binding vertices, in order to obtain a tree. It is necessary to locate one watcher on a  $g_2$ , two watchers on a  $g_3$  and, because a  $g_5$  has four ordinary

vertices, three watchers on a g5. So  $T$  attains the bound  $2k + 1$ : if there is a g2, we need one watcher for the g2 and  $2k$  watchers for the  $k$  g3's, if there is a g5, three watchers for the g5 and  $2k - 2$  watchers for the  $k - 1$  g3's.

We will prove the converse by induction on  $k$ . For  $k = 1$ ,  $n = 5$  and the result is clear, see Figure 3:  $T$  is a g5 (and in two out of three cases, it can also be seen as the connection of a g2 and a g3). We assume now that  $k \geq 2$  and that the theorem is true for  $k' < k$ . Let  $T$  be a tree of order  $n = 3k + 2$  with  $w(T) = 2k + 1$ . We consider again the proof of Theorem 4, using a path  $v_0, v_1, v_2, \dots, v_{D-1}, v_D$  with  $D$  edges, where  $D$  is the diameter of  $T$ .

- *Part (a): we assume that we are in the first or second case in the proof of Theorem 4*

In the first case, we rename the vertices  $v_{D-1}$ ,  $v_D$ ,  $x$  and  $v_{D-2}$  by  $a$ ,  $b$ ,  $c$  and  $d$ , respectively; in the second case, we rename the vertices  $v_{D-2}$ ,  $v_{D-1}$ ,  $v_D$  and  $v_{D-3}$  by  $a$ ,  $b$ ,  $c$  and  $d$ , respectively; we remove the vertices  $a$ ,  $b$  and  $c$  from  $T$  and obtain a tree  $T'$  of order  $3(k - 1) + 2$ ; by Remark 5, it appears that  $T'$  needs at least  $w(T) - 2 = 2k - 1$  watchers and so  $w(T') = 2(k - 1) + 1$  and we can apply the induction hypothesis to  $T'$ :  $T'$  is of one of the two types described in the right part of the equivalence, and the vertex  $d$  belongs to a gadget  $g$ , whose b. v. we denote by  $\alpha$ . Assume first that  $d \neq \alpha$ .

- (i) If  $g$  is of order 2, then the subtree induced by the vertices of  $g$  and the vertices  $a$ ,  $b$  and  $c$  yields a g5 of type a or b, and the result is proved for  $T$ .
- (ii) Assume next that  $g$  is of order 3. If  $T$  is of order 8, the two possibilities are given by Figure 16. Assume therefore that  $T$  is of order at least 11.

Then there are four cases: (ii1)  $\alpha$  is connected to a g2, which is itself connected to at least one more gadget, i.e., a g3; (ii2)  $\alpha$  is not connected to a g2, but is connected to a g3; (ii3)  $\alpha$  is not connected to a g2, but is connected to a g5; (ii4)  $\alpha$  is connected to a g2 connected only to  $g$ .

In the case (ii1), the left part of Figure 17 shows how to use only one watcher for  $g$ , which leads to a contradiction on  $w(T)$ . In the case (ii2), the same is true as shown by the right part of Figure 17, which actually is the same as Figure 12: notice that since  $\alpha$  is not connected to a g2, there does not have to be a watcher located at  $\alpha$ . The case (ii3) goes through in exactly the same way as (ii2), using Lemma 8. The final case (ii4) is treated in Figure 18.

- (iii) Finally, assume that  $g$  is of order 5. If  $T$  is of order 8, the reader will convince himself that locating  $d$  at all the different vertices, except at

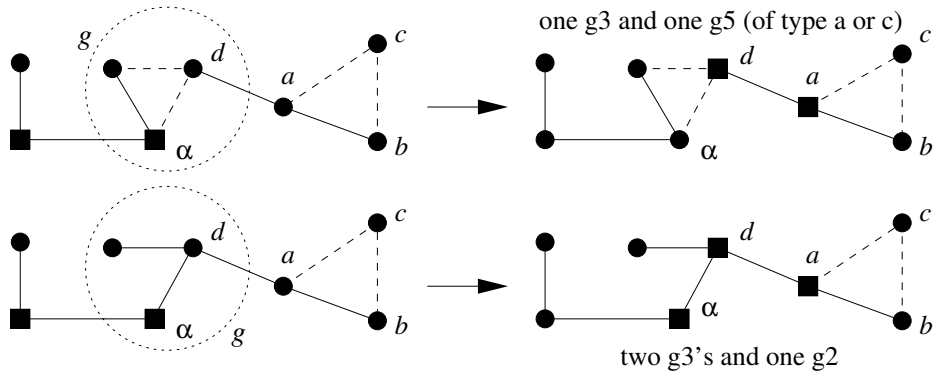

Figure 16: cases for  $n = 8$  in part (a) of Theorem 12, when  $g$  is of order 3

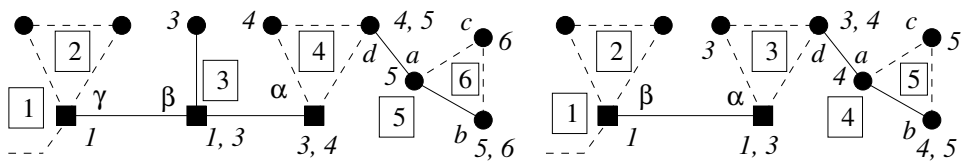

Figure 17: cases for  $n \geq 11$  in part (a) of Theorem 12, when  $g$  is of order 3



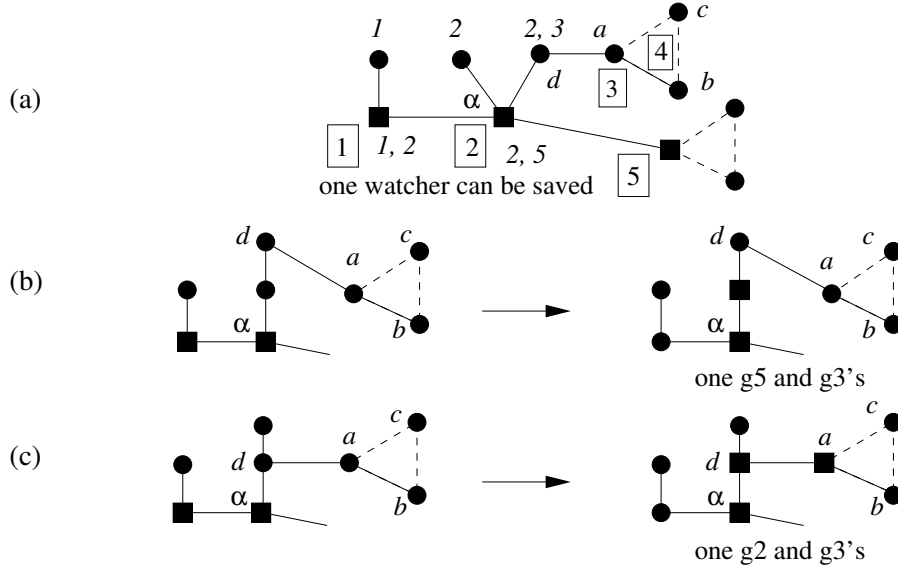

Figure 18: more cases for  $n \geq 11$  in part (a) of Theorem 12, when  $g$  is of order 3

the b. v.  $\alpha$ , of all the different types for a  $g_5$  leads to the six patterns given by Figure 19. If  $T$  is of order 11, the b. v.  $\alpha$  is adjacent to the b. v.  $\beta$  of a  $g_3$ . When one examines the different possibilities, it appears that if  $T$  reaches the bound, it is of the wished shape: this is shown by Figure 20.

To close the case when  $g$  is of order 5, we study the case when  $T$  is of order at least 14; then the tree  $T''$  obtained from  $T'$  by removing the four vertices of  $g$  other than  $\alpha$  has order at least 7 and we can apply Lemma 11 to it, which shows that the vertex  $\alpha$  is free in  $T''$ . Using Lemma 9, we can use two watchers on  $g$  to watch  $V(g) \setminus \{\alpha, d\}$  and cover the vertex  $d$ . With one watcher at  $a$  covering  $d$ , we can separate  $d$  from all the other vertices: so, we can do with only two watchers on  $g$ , and  $T$  does not attain the bound.

This shows that if  $d \neq \alpha$ , then either the tree does not attain the bound, or it is of the desired form. On the other hand, if  $d = \alpha$ , then the result is immediately obtained. This ends part (a).

- *Part (b): we assume that we are in the third or fourth case in the proof of Theorem 4*

If we are in the third case, we remove the vertices  $x$  and  $y$  and if we are in the fourth case, we remove the vertices  $v_{D-1}$  and  $v_D$ ; we obtain a tree  $T'$  of

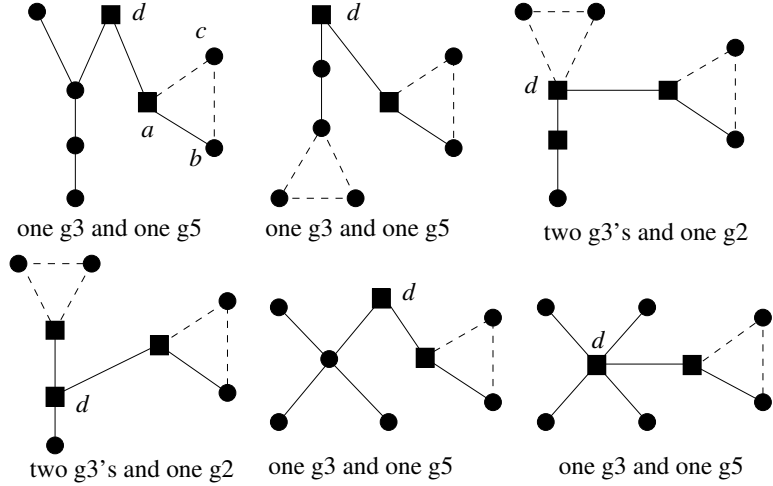

Figure 19: cases for  $n = 8$  in part (a) of Theorem 12, when  $g$  is of order 5

order  $3k$ . By Remark 5, we have  $w(T') = 2k$  and Theorem 7 may be used:  $T'$  can be obtained as a collection of  $g3$ 's linked by some edges between their binding vertices. So, the vertex  $v_0$  is a leaf of a  $g3$ , say  $g$ ; now we reverse the longest path  $v_0, v_1, \dots, v_D$  in  $T$ . If  $g$  is of type a (see the left part of Figure 21), then  $v_{D-1}$  is linked to only one b. v.,  $v_{D-2}$ , and has degree 3, because  $D$  is the diameter of the tree, and we are brought back to the first case. And if  $g$  is of type b, then  $v_{D-1}$  has degree 2, and either  $v_{D-2}$  has degree 2 and we are in the second case, or  $v_{D-2}$  has degree at least 3 and we are in the fourth case, with at least one b. v.  $x$  linked to  $v_{D-2}$  and  $x$  of degree at least 2 (see the right part of Figure 21); however,  $x$  cannot be linked to another b. v.  $\gamma$ , since this would increase the diameter of the tree, and for the same reason the  $g3$  of  $x$  is of type a, so that necessarily  $x$  has degree 3. With  $x$  playing the part of  $v_{D-1}$ , we are again in the first case. In all cases, we can re-use the result obtained in part (a).  $\square$

The last case,  $n = 3k + 1$  and  $w(T) = 2k$ , offers the greatest number of possibilities for the gadgets.

**Theorem 13** *Let  $T$  be a tree of order  $n = 3k + 1$  for  $k \geq 2$ . We have:  $w(T) = 2k \Leftrightarrow T$  can be obtained by choosing*

- (i) *two gadgets of order 2 and  $k - 1$  gadgets of order 3,*
- (ii) *or one gadget of order 2, one gadget of order 5 and  $k - 2$  gadgets*

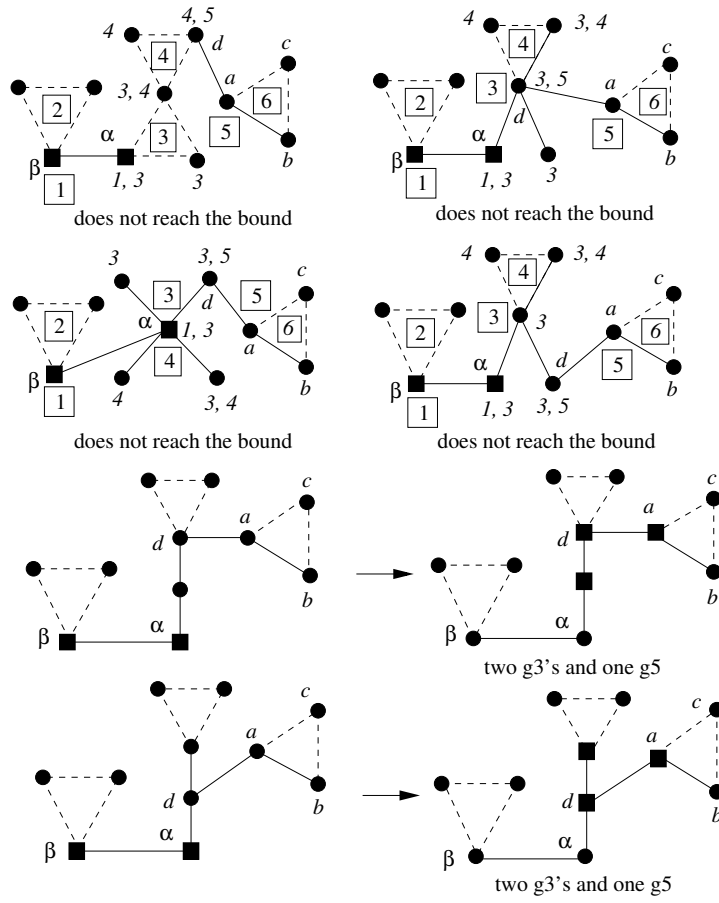

Figure 20: cases for  $n = 11$  in part (a) of Theorem 12, when  $g$  is of order 5

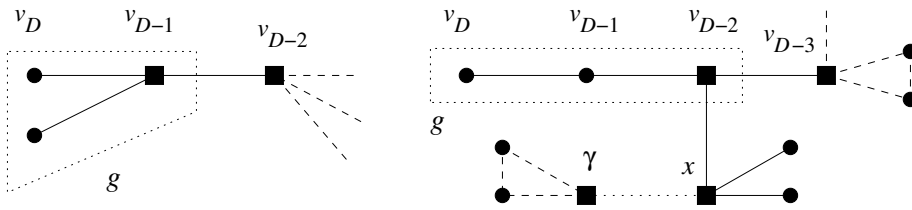

Figure 21: illustration for part (b) of Theorem 12

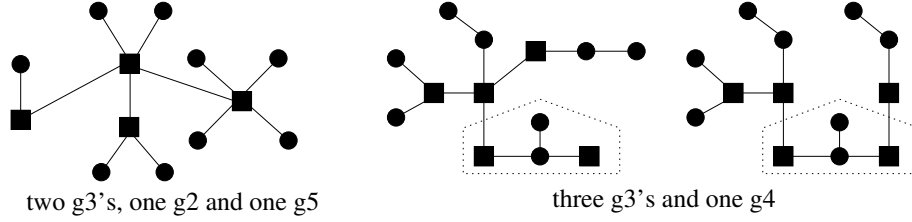

Figure 22: the trees  $T_{13}$ ,  $T'_{13}$  and  $T''_{13}$

of order 3,

- (iii) or two gadgets of order 5 and  $k - 3$  gadgets of order 3,
- (iv) or one gadget of order 1 and  $k$  gadgets of order 3,
- (v) or one gadget of order 4 and  $k - 1$  gadgets of order 3,

and joining these gadgets by their binding vertices to obtain a tree.

In  $T$ , it may be that one of the two binding vertices of a  $g_4$  is not connected to any (binding) vertex. In this case, this  $g_4$ , depending on its type and its connection, can be viewed as two  $g_2$ 's, or one  $g_1$  and one  $g_3$ . So we can assume that, if there is a  $g_4$  (case (v) of the theorem), then each of the two b. v.'s of the  $g_4$  is connected to at least one  $g_3$ . This will be used in the proof below.

The trees  $T_{13}$ ,  $T'_{13}$  and  $T''_{13}$  of Figure 22 are examples of trees attaining the bound  $2k$  for  $n = 3k + 1$  (with  $k = 4$ ).

**Proof.** Assume that a tree  $T$  of order  $n = 3k + 1$  is obtained as specified in the right part of the above equivalence. It is necessary to locate one watcher on a  $g_2$ , two watchers on a  $g_3$  and two on a  $g_4$  (because a  $g_4$  has two ordinary vertices), and three watchers on a  $g_5$ . So  $T$  reaches the bound  $2k$ :

- if we are in (i),  $(2 \times 1) + ((k - 1) \times 2) = 2k$ ;
- in (ii),  $(1 \times 1) + (1 \times 3) + ((k - 2) \times 2) = 2k$ ;
- in (iii),  $(2 \times 3) + ((k - 3) \times 2) = 2k$ ;
- in (iv),  $(1 \times 0) + (k \times 2) = 2k$ ;
- in (v),  $(1 \times 2) + ((k - 1) \times 2) = 2k$ .

We will prove the converse by induction on  $k$ . For  $n = 7$ , the different possibilities are examined on Figure 23. Now, we assume that  $n \geq 10$ .

We use the same scheme of proof as for Theorem 12: we assume that  $k \geq 3$  and that the theorem is true for  $k' < k$ , we let  $T$  be a tree of order

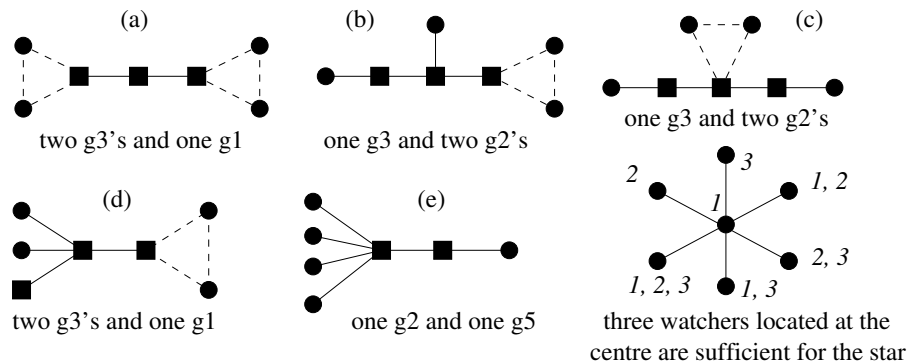

Figure 23: all the possibilities for  $n = 7$  in Theorem 13

$n = 3k + 1$  with  $w(T) = 2k$ , and we consider the proof of Theorem 4, using a path  $v_0, v_1, v_2, \dots, v_{D-1}, v_D$  with  $D$  edges, where  $D$  is the diameter of  $T$ .

- *Part (a): we assume that we are in the first or second case in the proof of Theorem 4*

In the first case, we rename the vertices  $v_{D-1}, v_D, x$  and  $v_{D-2}$  by  $a, b, c$  and  $d$ , respectively; in the second case, we rename the vertices  $v_{D-2}, v_{D-1}, v_D$  and  $v_{D-3}$  by  $a, b, c$  and  $d$ , respectively. In both cases, we remove the vertices  $a, b$  and  $c$  from  $T$  and obtain a tree  $T'$  with order  $3(k-1) + 1$ ; by Remark 5, it appears that  $T'$  needs at least  $w(T) - 2 = 2k - 2$  watchers and so  $w(T') = 2(k-1)$ : we can apply the induction hypothesis to  $T'$ , which is of one of the five types described in the right part of the equivalence.

The vertex  $d$  belongs to a gadget  $g$ ; as before, if  $d$  is a binding vertex, we are done, so we assume from now on that  $d$  is ordinary, so that  $g$  is of order 2 or more, and we have four cases, according to the order of  $g$ .

- (1) If  $g$  is of order 2, the subtree induced by the vertices of  $g$  and the vertices  $a, b$  and  $c$  yields a  $g5$  and the result is proved: indeed, if  $T'$  has two  $g2$ 's and  $k-2$   $g3$ 's (case (i)), or one  $g2$ , one  $g5$  and  $k-3$   $g3$ 's (case (ii)), then  $T$  can be obtained with one  $g2$ , one  $g5$  and  $k-2$   $g3$ 's (case (ii)), or two  $g5$ 's and  $k-3$   $g3$ 's (case (iii)), respectively.

- (2) Assume next that  $g$  is of order 3, with binding vertex  $\alpha$ .

If  $n = 10$ , we consider for  $T'$  the cases in Figure 23 where there is at least one  $g3$ , that is, the cases (a)–(d). The cases (a) and (d), where there is a  $g1$ , will be studied below, for general values of  $n$ . If, in the case (b),  $g$  is of type a, then, see Figure 24(a), five watchers are sufficient to watch  $T$ ,

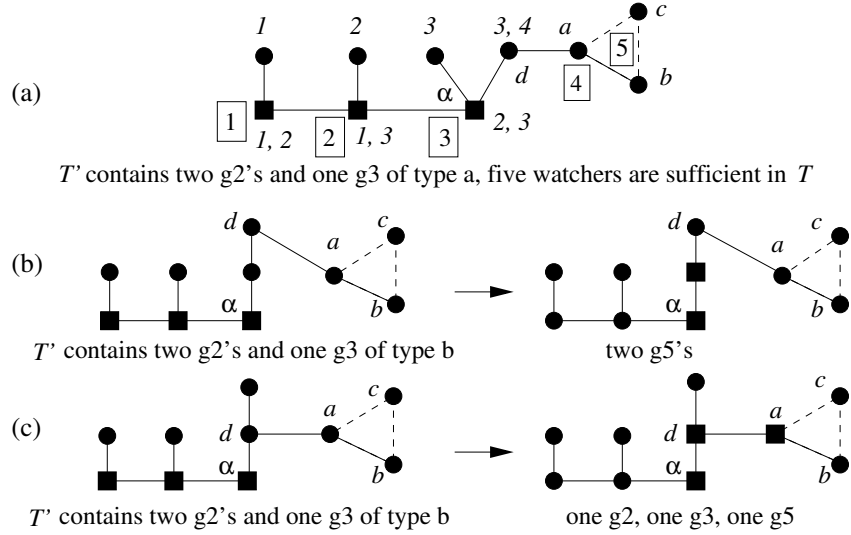

Figure 24: cases for  $n = 10$  in part (a) of Theorem 13, when  $g$  is a  $g3$

whereas if  $g$  is of type b, then, according to the location of  $d$  in  $g$ ,  $T$  consists of two  $g5$ 's, or of one  $g2$ , one  $g3$  and one  $g5$ , see Figure 24(b) and (c).

Similarly, if in the case (c) of Figure 23,  $g$  is of type a, then five watchers are sufficient, whereas if  $g$  is of type b, then  $T$  consists of one  $g2$ , one  $g3$  and one  $g5$ , or of two  $g3$ 's and two  $g2$ 's — cf. Figure 30(a) below.

We consider now the case when there is a  $g1$ , with vertex  $\delta$ , in  $T'$ , with  $n \geq 10$ : we are in case (iv) of Theorem 13 and all the other gadgets in  $T'$  are  $g3$ 's. If  $\delta$  is linked neither to  $\alpha$  nor to any neighbour of  $\alpha$ , we are in the situation depicted by Figure 25(a) and  $2k - 1$  watchers are sufficient for  $T$ : since  $\gamma$  or  $\delta$  is linked to another  $g3$ , these two vertices can be separated by another watcher. So we can assume from now on that  $\delta$  is linked either to  $\alpha$  or to one of its neighbours. First, we assume that  $\alpha$  is linked to at least one  $g3$ , cf. the left part of the tree in Figure 25(a). Again, we can save one watcher, so that  $T$  does not attain the bound  $2k$ , unless we are in one of the following three cases:

(i)  $\delta$  is linked only to  $\alpha$ , see Figure 25(b). Then either  $\delta$  is not covered by any watcher, or it is covered by the watcher 3 located at  $\alpha$ , in which case no watcher separates  $e$  and  $\delta$ . This gives the three possibilities detailed in Figure 26.

(ii)  $\delta$  is linked to  $\alpha$  and to exactly one other  $g3$ , which is not linked to any other  $g3$ , and the watcher 3 cannot be located at  $\alpha$ , which means that  $g$

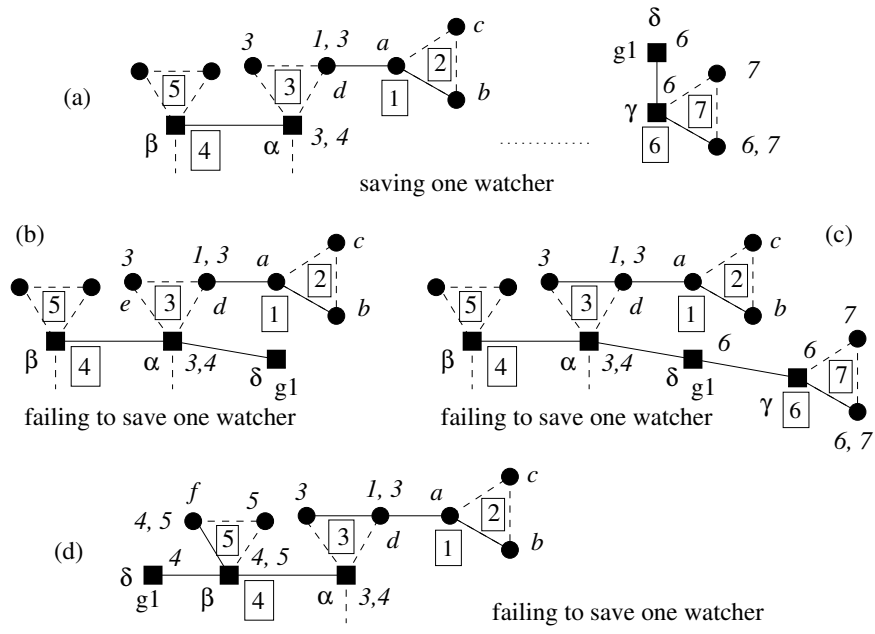

Figure 25: part (a) of Theorem 13:  $g$  is a  $g_3$  and there is a  $g_1$

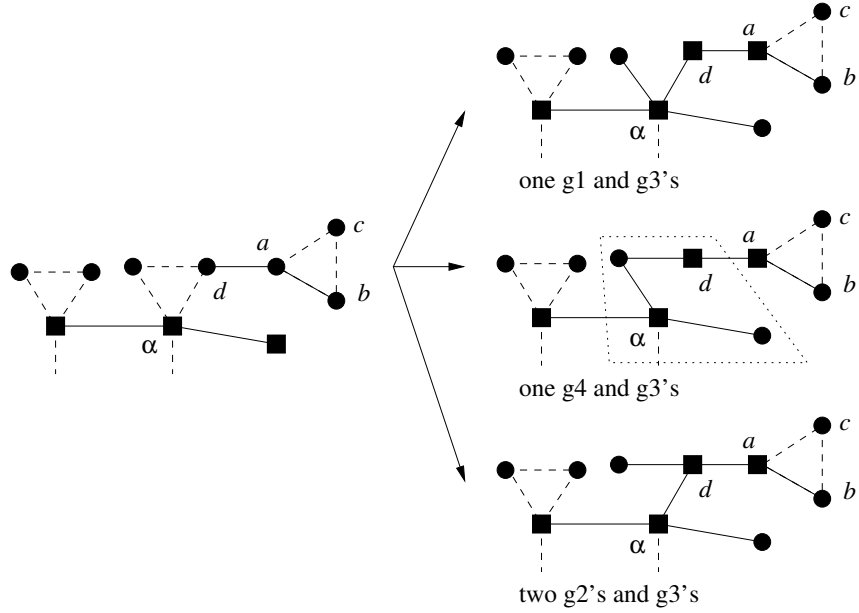

Figure 26: cases with a  $g_1$  in part (a) of Theorem 13, when  $g$  is a  $g_3$

is of type b, see Figure 25(c), where  $\gamma$  and  $\delta$  are not separated. Then there are two possibilities, given in Figure 27.

(iii)  $\delta$  is linked to a neighbour  $\beta$  of  $\alpha$ , and neither  $\delta$  nor  $\beta$  is linked to other b. v.'s, and  $g$  is of type b, see Figure 25(d), where  $\beta$  and  $f$  are not separated. Figure 28 shows then that we still are in the conditions of Theorem 13.

Now we can assume that  $\alpha$  is not linked to any  $g_3$ , which means that it is linked to  $\delta$ , which in turn is linked to at least one  $g_3$ ; then a  $g_4$  appears, containing  $g$  and  $\delta$ , and with binding vertices  $d$  and  $\delta$ . So the case when there is a  $g_1$  in  $T'$  is closed, also completing the case  $n = 10$ . From now on, we assume that  $n \geq 13$  and that there is no  $g_1$  in  $T'$ .

We can remark the following: if in  $T'$  we have a  $g_4$ , and if one of its binding vertices is connected to a  $g_3$ , it is always possible to locate  $w(T')$  watchers on  $T'$  with one watcher at the second binding vertex  $v$  of the  $g_4$ , see Figure 29. Since each of the two b. v.'s of the  $g_4$  has been required to be connected to at least one b. v. of a  $g_3$ , this means that if there is a  $g_4$  and one of its b. v.'s, say  $\beta$ , is connected to  $\alpha$ , then we can, using Figure 29, locate one watcher at  $\beta$ , in order to possibly cover  $\alpha$ . This or Lemma 6



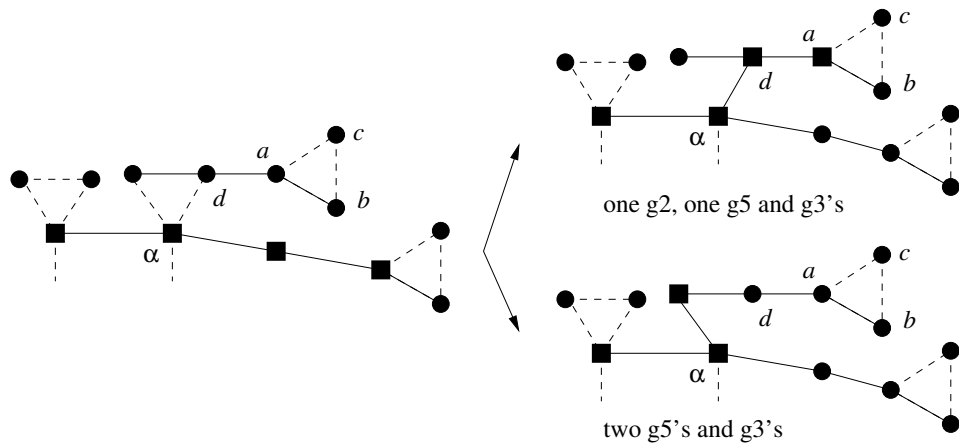

Figure 27: more cases with a  $g_1$  in part (a) of Theorem 13, when  $g$  is a  $g_3$

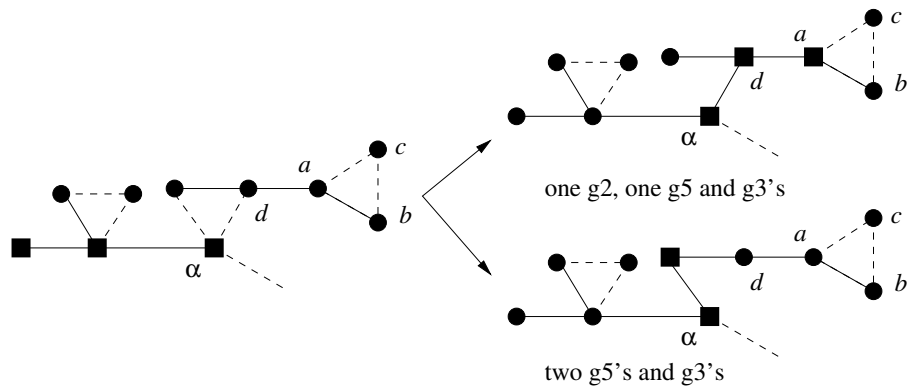

Figure 28: last cases with a  $g_1$  in part (a) of Theorem 13, when  $g$  is a  $g_3$

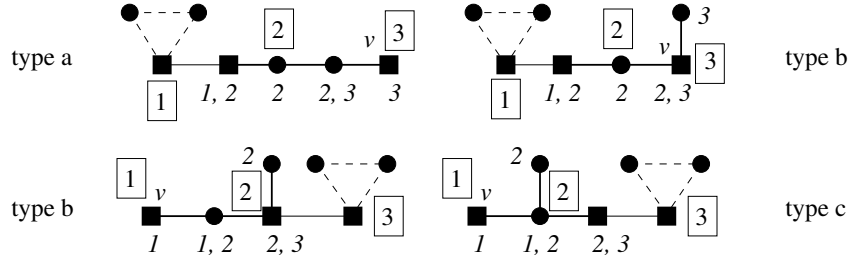

Figure 29: choice of a watcher at a binding vertex of a  $g_4$

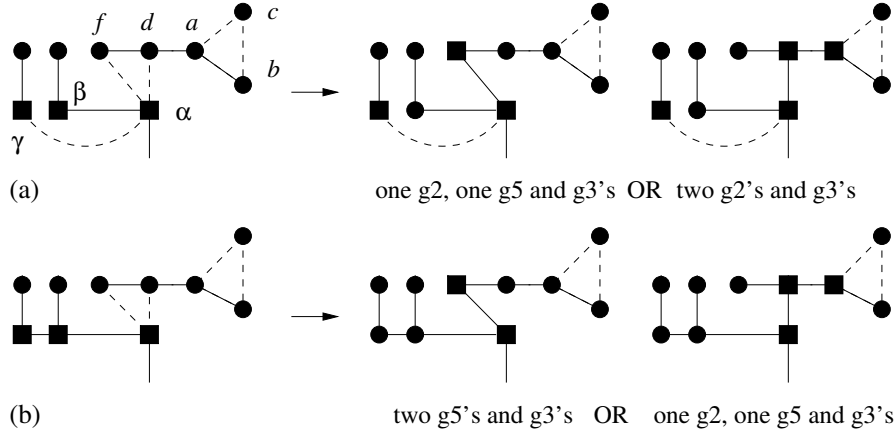

Figure 30: cases with two  $g_2$ 's in part (a) of Theorem 13, when  $g$  is a  $g_3$

allows us to save one watcher on  $g$  whenever there is one  $g_4$  in  $T'$ , exactly as we did in the left part of Figure 25(a), with  $\beta$  covering  $\alpha$ . So we can assume that there is no  $g_4$  in  $T'$ .

If there are no  $g_2$ 's either in  $T'$ , i.e., there are only  $g_3$ 's and  $g_5$ 's, then we can again save one watcher on  $g$ , using Lemma 6 or Lemma 8.

Therefore, we have only one case left when  $g$  is a  $g_3$ : when  $T'$  contains at least one gadget of order 2. If there is exactly one  $g_2$  (case (ii) of Theorem 13), the situation is very close to that of Theorem 12 (see Figure 18 and the left part of Figure 17), the difference being the existence of a  $g_5$ . So we assume that  $T'$  contains two  $g_2$ 's, and  $g_3$ 's (case (i) of Theorem 13). In general, one can still save one watcher on  $g$ ; the two critical situations are given by Figure 30, in which a single watcher located on  $g$  cannot simultaneously cover  $d$ ,  $f$  and  $\beta$  (and  $\gamma$  when  $\gamma$  is connected to  $\alpha$ ) — cf. Figure 24.

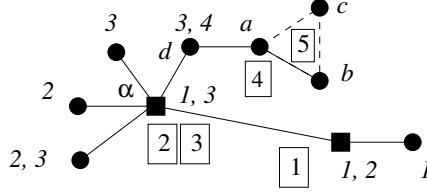

Figure 31: case  $n = 10$  in part (a) of Theorem 13, when  $g$  is a  $g_5$ : five watchers are sufficient

- (3) Assume now that  $g$  is of order 5, with binding vertex  $\alpha$  ( $\alpha \neq d$ ). The other gadgets in  $T'$  are either one  $g_2$  and  $k - 3$   $g_3$ 's, or one  $g_5$  and  $k - 4$   $g_3$ 's. We illustrate the cases occurring when in  $T'$ ,  $\alpha$  is linked to the  $g_2$  and only to this gadget: Figure 31 is for  $n = 10$  and uses the only representation with one  $g_5$  for a tree of order 7, cf. Figure 23(e); Figure 32 is for  $n \geq 13$  and is obtained by locating  $d$  at all the different vertices, except at the b. v.  $\alpha$ , in all the different types for a  $g_5$ , cf. Figure 20.

There are three other cases: (i) the  $g_2$  is linked only to  $\alpha$ ; (ii) the  $g_2$  is not linked to  $\alpha$ ; (iii) there is no  $g_2$ , but another  $g_5$ . Very similar to Figure 32 or to previous studies involving  $g_5$ 's, these cases often use Lemma 9 and are left to the reader.

- (4) The final case of this part (a) is when  $g$  is a  $g_4$ , with its two binding vertices  $\alpha$  and  $x$  ( $\alpha \neq d, x \neq d$ ) connected to other gadgets, and in  $T'$  all gadgets except  $g$  are  $g_3$ 's (case (v) of Theorem 13). Denote by  $T''$  the connected component containing  $x$  in the forest obtained from  $T'$  by removing the edges of  $g$ , see Figure 33. Assume that  $T''$  is of order at least 7; then by Lemma 11,  $x$  is free in  $T''$ . In a minimum watching system for  $T$ , we can assume that there is one watcher located at  $a$  which covers  $d$ , and one watcher located at  $\beta$  which covers  $\alpha$ . Then (see Figure 34), either only one more watcher, denoted by 3, is necessary inside  $g$  to watch  $T$ , and  $T$  does not reach the bound  $2k$ , or  $T$  consists of one  $g_2$ , one  $g_5$  and  $g_3$ 's, or of two  $g_5$ 's and  $g_3$ 's. The same argument with  $\alpha$  shows that we can assume that each b. v. of  $g$  is linked to exactly one  $g_3$ ; then  $n = 13$  and Figure 35 gives all the possible cases.

- *Part (b): we assume that we are in the third or fourth case in the proof of Theorem 4*

If we are in the third case, we rename the vertices  $x, y$  and  $v_{D-1}$  by  $a, b$  and  $d$ , respectively, and if we are in the fourth case, we rename the vertices  $v_{D-1}$ ,

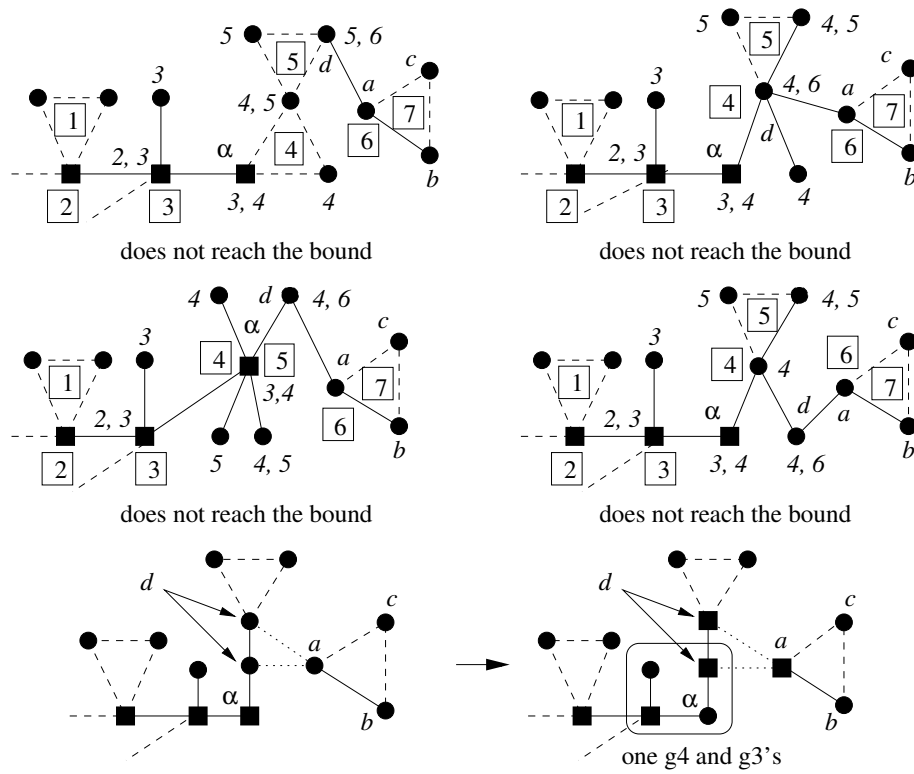

Figure 32: cases when  $g$  is a  $g_5$  in part (a) of Theorem 13, for  $n \geq 13$

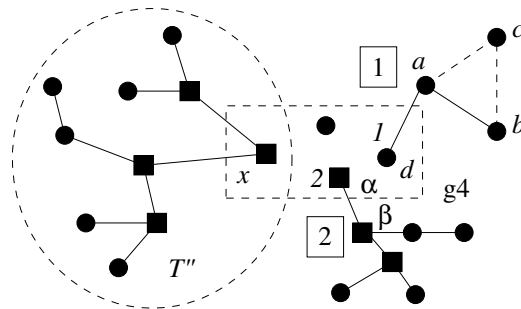

Figure 33: the definition of  $T''$  in part (a) of Theorem 13

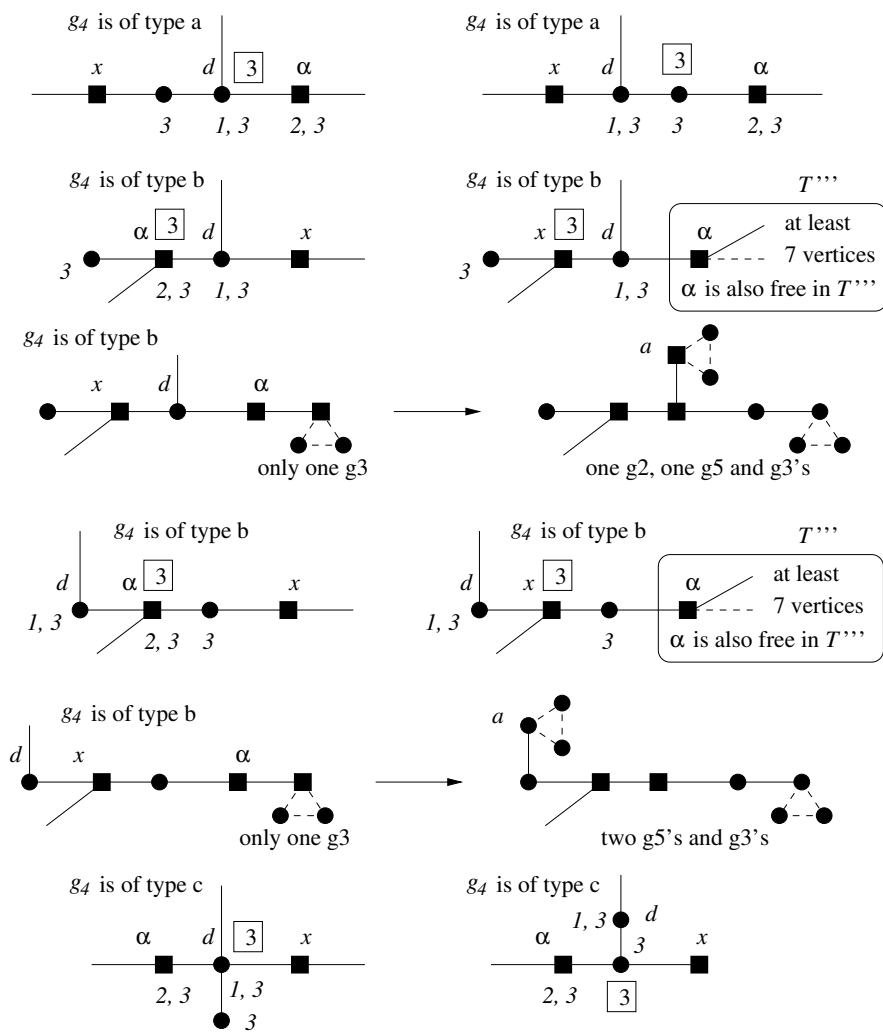

Figure 34: part (a) of Theorem 13:  $T'''$  is of order at least 7 and  $x$  is free in  $T'''$

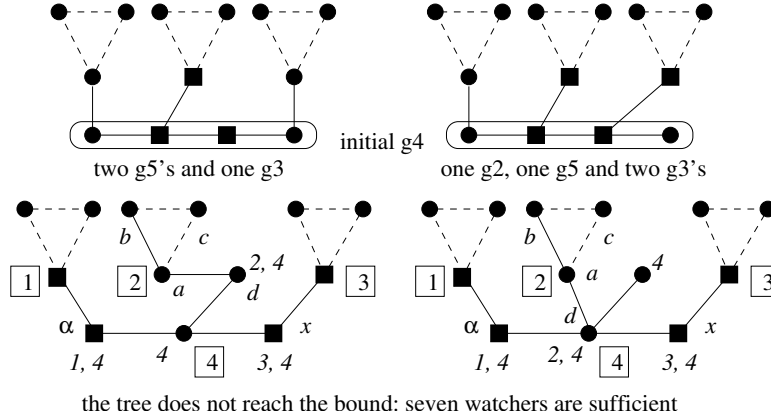

Figure 35: the remaining cases when  $g$  is a  $g_4$  in part (a) of Theorem 13

$v_D$  and  $v_{D-2}$  by  $a$ ,  $b$  and  $d$ , respectively; in both cases, we remove  $a$  and  $b$ , obtaining a tree  $T'$  of order  $3(k-1)+2$ . By Remark 5,  $w(T') = 2(k-1)+1$  and Theorem 12 may be used:  $T'$  can be obtained by choosing one  $g_2$  or one  $g_5$  and a collection of  $g_3$ 's linked by their binding vertices. Note that the vertex  $d$  has degree at least 2 in  $T'$ ; it belongs to a gadget  $g$  with b. v.  $\alpha$ .

We first assume that  $d \neq \alpha$ . Because of the degree of  $d$ , the gadget  $g$  cannot be of order 2, and if it is of order 3, with vertex set  $\{\alpha, d, c\}$ , then its edge set is  $\{\{d, \alpha\}, \{d, c\}\}$ , and  $\{a, b, c, d, \alpha\}$  is a  $g_5$  of type  $c$  or  $d$ :  $T$  is of the desired form. We are left with the case when  $g$  is a  $g_5$ , in which  $d$  has degree 2 or more, and the other gadgets in  $T'$  are all  $g_3$ 's; this is depicted in Figure 36, where we give the locations of the watchers showing that  $T$  does not reach the bound  $2k$ , or show the b. v.'s of the gadgets involved; note that if  $n \geq 13$ , then by Lemma 11,  $\alpha$  is free in  $T'$  deprived of the four ordinary vertices of  $g$ .

Finally, if  $d = \alpha$ , then Figures 37–39 give the different cases, according to the order of  $g$ . This completes the proof of Theorem 13.  $\square$

## 4 Graphs $G$ reaching the maximum value of $w(G)$

We first give the following definition.

**Definition 14** A connected graph  $G$  is said to be maximal if, when we add any edge to  $G$ , we obtain a graph  $G'$  for which  $w(G') < w(G)$ .

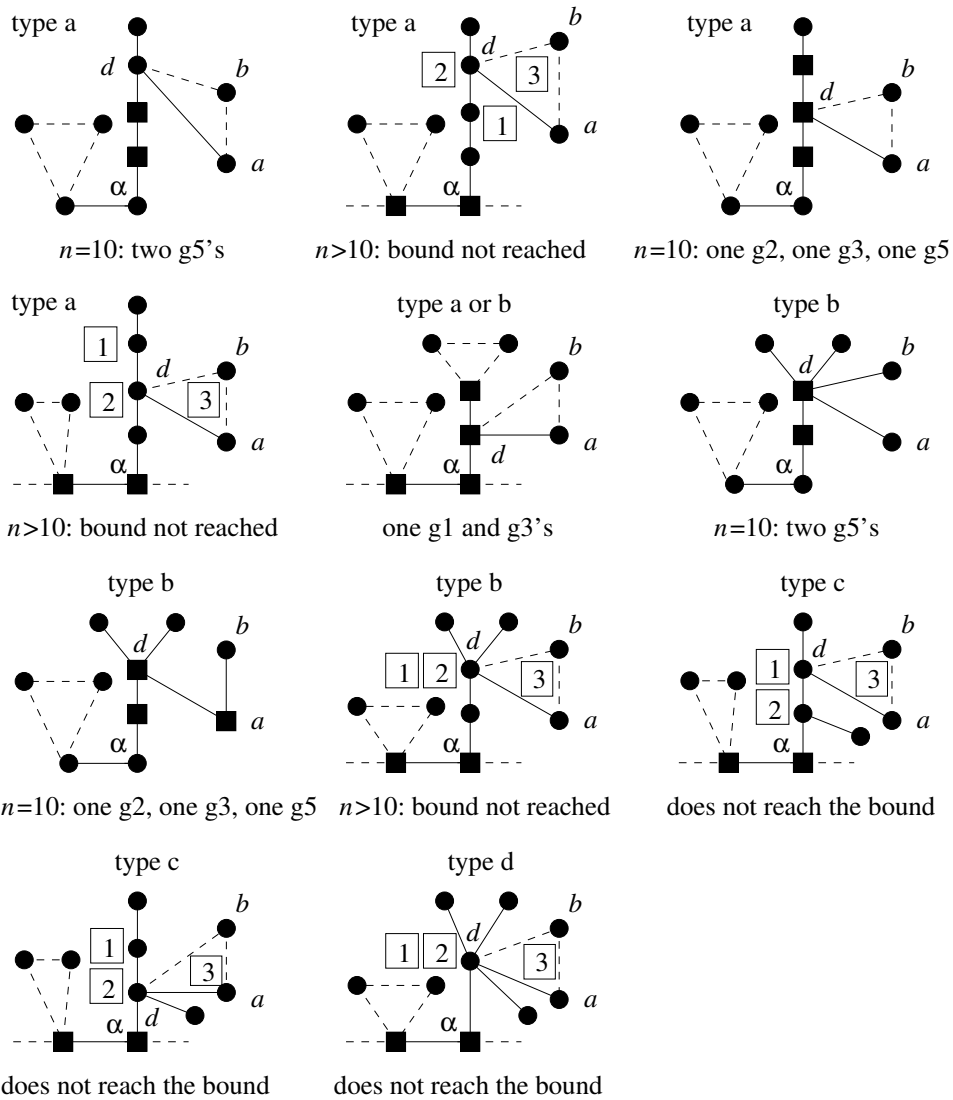

Figure 36: illustration for part (b) of Theorem 13, when  $g$  is a  $g_5$  and  $d \neq \alpha$

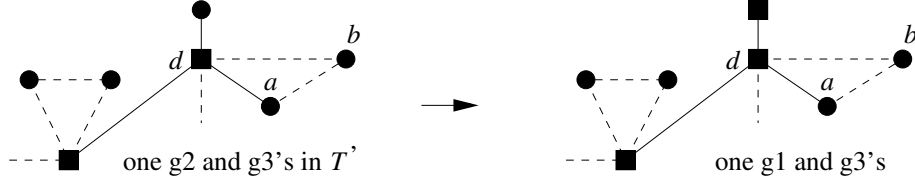

Figure 37: illustration for part (b) of Theorem 13, when  $d = \alpha$  and  $g$  is a  $g_2$

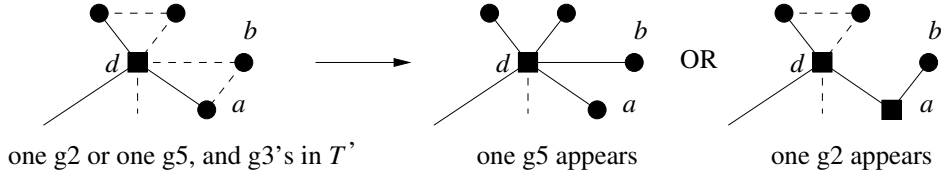

Figure 38: illustration for part (b) of Theorem 13, when  $d = \alpha$  and  $g$  is a  $g_3$

We denote by  $\omega(n)$  the maximum of minimum number of watchers needed in a connected graph of order  $n$ , i.e.,

$$\omega(n) = \max\{w(G) : G \text{ connected of order } n\}.$$

In the previous section, we have established that  $\omega(n) = \lfloor \frac{2n}{3} \rfloor$  for  $n \notin \{1, 2, 4\}$ , and we have characterized the trees of order  $n$  reaching  $\omega(n)$ . In this section, we want to describe all the maximal connected graphs of order  $n$  which reach  $\omega(n)$ . Using Lemma 1, the graphs of order  $n$  which reach  $\omega(n)$  are exactly the connected partial graphs of the maximal connected graphs of order  $n$  reaching  $\omega(n)$ .

We recall that  $K_p$  denotes the complete graph (or clique) of order  $p$ . Again, we divide our study into three cases,  $n = 3k$ ,  $n = 3k + 2$  and  $n = 3k + 1$ .

**Theorem 15** *Let  $k$  be an integer,  $k \geq 1$ , and  $G$  be a maximal graph of order  $3k$ . We have:  $w(G) = 2k \Leftrightarrow G$  is obtained by taking a collection of  $k$   $K_3$ 's, choosing one vertex named a binding vertex in each  $K_3$ , and connecting these  $k$  binding vertices by  $K_k$ .*

For instance, the graph  $G_{15}$  of Figure 40 is the unique maximal graph of order 15 reaching the bound  $\omega(15) = 10$ .

**Proof.** The implication from the right to the left is direct. So, given a maximal graph  $G$  of order  $3k$  satisfying  $w(G) = 2k$ , we have to prove that



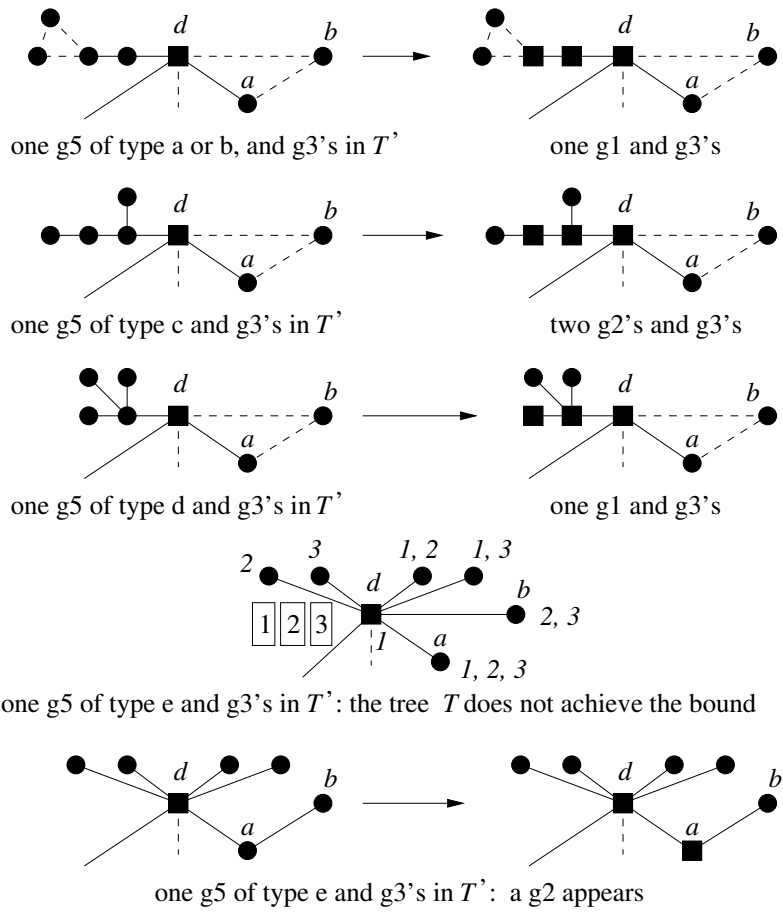

Figure 39: illustration for part (b) of Theorem 13, when  $d = \alpha$  and  $g$  is a  $g_5$

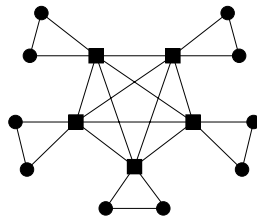

Figure 40:  $G_{15}$ , the maximal graph of order 15 reaching the bound

$G$  is of the form described in the theorem. Let  $T$  be a spanning tree of  $G$ . Using Lemma 1 and Theorem 4, we can see that  $w(T) = 2k$ . By Theorem 7,  $T$  is a collection of  $k$  gadgets of order 3 connected by their binding vertices. We shall show that in  $G$  any edge which is not in  $T$  is an edge between two b. v.'s of  $T$ , or is the missing edge of a g3; to do this, we assume that there is in  $G$  an edge  $e$  which is not an edge between two b. v.'s of  $T$ , nor the missing edge of a g3. In Figure 41, we consider the four possibilities:

(a) The edge  $e$  links an ordinary vertex  $a$  of a g3, denoted by  $g_3$ , whose b. v. is denoted by  $\beta$ , and the b. v.  $\alpha$  of another g3, and the edge  $\{\alpha, \beta\}$  exists; then, whatever the type of  $g_3$ , we can locate a watcher 3 on  $g_3$  covering  $a$ ,  $b$  and  $\alpha$ , and the six vertices are covered and separated by three watchers only.

(b)  $e$  links two ordinary vertices of two g3's which are linked by their b. v.'s. Again, the six vertices involved can be watched by three watchers.

In passing, these two cases show how to handle the case  $n = 6$ , so from now on we assume that  $n \geq 9$ .

(c)  $e$  links an ordinary vertex of a g3, whose b. v. is  $\beta$ , and the b. v.  $\alpha$  of another g3, and  $\{\alpha, \beta\}$  does not exist. Then  $\alpha$  and  $\beta$  are linked to at least one other g3 (possibly the same), because in the spanning tree  $T$ , there is a connection between any two b. v.'s.

(d) This is also true when  $e$  links two ordinary vertices of two g3's which are not linked by their b. v.'s.

In each of these two cases, we can see that we are able to locate only one watcher on a g3, so there is a contradiction with the value of  $w(G)$ .

Furthermore, if we add to  $T$  the missing edge on each g3 and all the missing edges between the b. v.'s of  $T$ , the number of needed watchers remains equal to  $2k$ : we have obtained the unique maximal graph containing  $T$ .  $\square$

**Theorem 16** (a) *Let  $k$  be an integer,  $k \geq 3$ , and  $G$  be a maximal graph of order  $3k+2$ . We have:  $w(G) = 2k+1 \Leftrightarrow G$  is obtained by taking a collection of  $k$   $K_3$ 's and one  $K_2$ , or  $k-1$   $K_3$ 's and one  $K_5$ , choosing one vertex named a binding vertex in each of these complete graphs, and connecting these binding vertices by  $K_{k+1}$  if we have taken a  $K_2$ , and by  $K_k$  if we have taken a  $K_5$ .*

(b) *If  $G$  is a maximal graph of order 8, then we have:  $w(G) = 5 \Leftrightarrow G$  is the graph given by Figure 42, or  $G$  is obtained by following the rules given in Case (a), for  $k = 2$ .*

(c) *The only maximal graph  $G$  of order 5 with  $w(G) = 3$  is the clique  $K_5$ .*

For instance, the graphs  $G_{17}$  and  $G'_{17}$  of Figure 43 are the two maximal graphs of order 17 reaching the bound  $\omega(17) = 11$ .

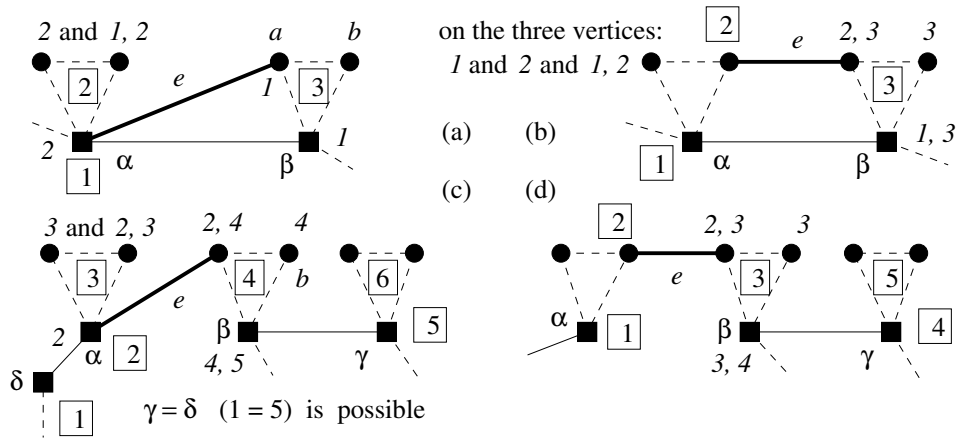

Figure 41: forbidden edges between two  $g_3$ 's in the proof of Theorem 15

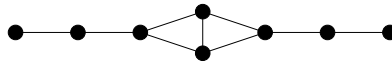

Figure 42: a maximal graph of order 8 reaching the bound

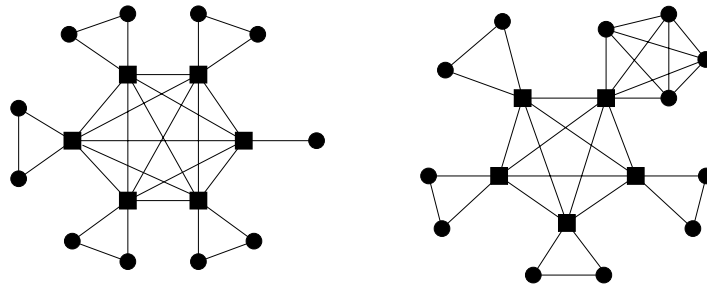

Figure 43: the two maximal graphs of order 17 reaching the bound

**Proof.** The implications from the right to the left are direct. So, given a maximal graph  $G$  of order  $3k + 2$  satisfying  $w(G) = 2k + 1$ , we have to prove that  $G$  is of the form(s) described in the theorem.

By inequality (1) from the Introduction and Theorem 4, all connected graphs  $G$  of order 5 are such that  $w(G) = 3$ ,  $K_5$  is the unique maximal graph of order 5, and Case (c) is true.

The case  $n = 8$ , which does not fit the general framework either, is rather tedious to check, and is not given here.

We assume from now on that  $n \geq 11$ . Let  $T$  be a spanning tree of  $G$ . Using Lemma 1 and Theorem 4, we can see that  $w(T) = 2k + 1$ . From Theorem 12,  $T$  can be obtained as one g2 or one g5 plus a collection of g3's, with the gadgets connected by their binding vertices to form a tree. If, among the spanning trees of  $G$ , there is one with a g5, we choose this tree; and if, in all the spanning trees, we cannot avoid a g2, then we choose a tree in which the b. v. of the g2 has maximum degree (in the tree).

We shall list pairs of vertices which cannot be adjacent in the maximal graph  $G$ : between g3's, between the g5 and a g3, and between the g2 and a g3 (the most delicate case).

- (1) Assume first that there is an edge between two g3's, with at least one of its ends different from a b. v. This case has been treated for Theorem 15, cf. Figure 41. If now  $\beta$ , the b. v. of  $g_3$ , is not linked to any b. v. other than  $\alpha$ , or if  $\beta$  is linked to the b. v. of a g3 other than  $\alpha$ , then we can save one watcher in exactly the same way as on Figure 41. If  $\beta$  is linked to the b. v.  $\gamma$  of the g5, by Lemma 8 we can have a watcher located at  $\gamma$  and covering  $\beta$ , thus still saving one watcher on  $g_3$ . So we can assume that  $\beta$  is linked to the b. v.  $\gamma$  of the g2. In cases (b) and (d) of Figure 41, we can save one watcher on the g3 with b. v.  $\alpha$ , since  $\alpha$  and  $\beta$  play symmetrical parts. In case (c), in all cases, but one, we can still save one watcher on  $g_3$ : the critical case (see Figure 44) is when the g2 has no connection other than  $\beta$ , and moreover the watcher 4, which is used to cover  $b$ , cannot be located at  $\beta$ , so that the two vertices of the g2 are not separated, and we cannot save one watcher; in this case however, since the b. v.'s  $\alpha, \beta, \gamma, \delta, \dots$  in  $T$  are connected, it is possible to add in  $T$  the edge  $e = \{\alpha, a\}$  and delete one edge between two b. v.'s, so that the result is a spanning tree of  $G$ , in which  $\gamma$  becomes an ordinary vertex in a g3, and  $a$  becomes the b. v. of the g2, now connected to two g3's. This means that the spanning tree in the left part of the figure cannot have been chosen, since the b. v. of its g2,  $\gamma$ , does not have maximum degree among the spanning trees of  $G$ . Case (a) of Figure 41 can be dealt with in the same way, with a critical situation similar to Figure 44, where we can add the edge  $\{\alpha, a\}$  and delete the edge  $\{\alpha, \beta\}$ .

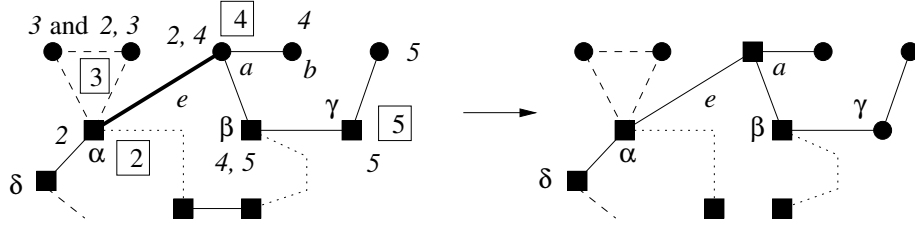

Figure 44: forbidden edges between two  $g_3$ 's: a critical case in part (1) of Theorem 16

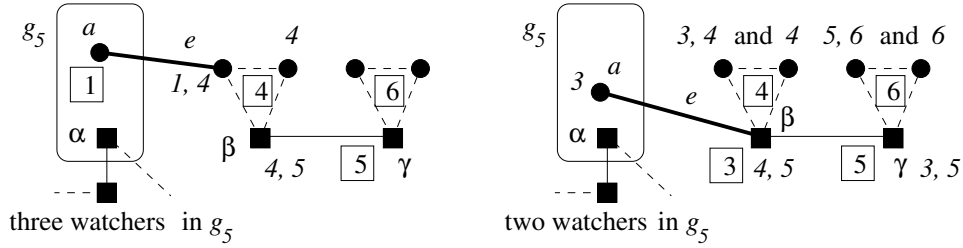

Figure 45: part (2) of Theorem 16: forbidden edges between a  $g_5$  and a  $g_3$

- (2) Assume next that there is one  $g_5$ , named  $g_5$ , in  $T$ , and that there is in  $G$  an edge  $e$  between  $g_5$  and a  $g_3$ ,  $g_3$ , with at least one of its ends different from  $a$ . v. Let  $\alpha$  and  $\beta$  be the b. v.'s of  $g_5$  and  $g_3$ , respectively. If the edge  $\{\alpha, \beta\}$  does not exist, then  $\alpha$  and  $\beta$  are connected to at least one other  $g_3$  (possibly the same), and we can save one watcher, using in particular Lemma 8: see Figure 45, where  $a$  can be equal to  $\alpha$  in the left part. In the right part, since  $\alpha$  is free in the tree  $T'$  consisting of the spanning tree  $T$  deprived of the four ordinary vertices of  $g_5$  (even if  $\alpha$  is linked only to  $\gamma$ , in which case  $\alpha$  is covered by the watcher 5), we are left with the problem of taking care of the three vertices  $x, y, z$  of  $g_5$  other than  $a$  and  $\alpha$ , with only two watchers; this can be done using Lemma 9.

So from now on we assume that we have the edge  $\{\alpha, \beta\}$  in  $T$ . Because  $n \geq 11$ ,  $\alpha$  is still free in  $T'$ , and obviously, if both  $\alpha$  and  $\beta$  are still connected to other  $g_3$ 's, the argument above still works. So we assume that only one of  $\alpha$  and  $\beta$  is connected to (at least) one (other)  $g_3$ . We first consider the case when it is  $\beta$ .

Figure 46 depicts the situation, where  $a$  can be equal to  $\alpha$  in the left part. In this left part, thanks to Lemma 8, the situation is the same as previously

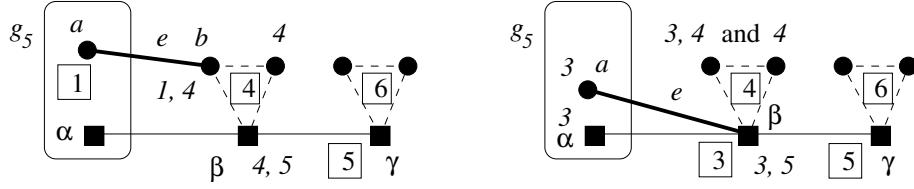

Figure 46: part (2) of Theorem 16: forbidden edges between a  $g_5$  and a  $g_3$ , with  $\{\alpha, \beta\}$  in  $T$

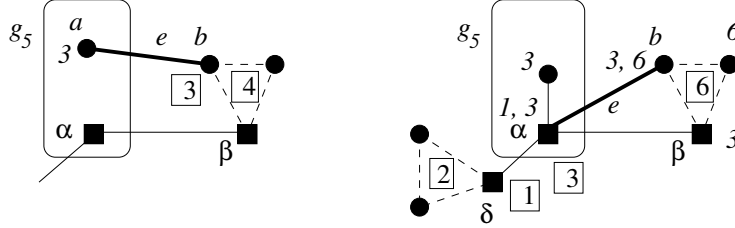

Figure 47: part (2) of Theorem 16: more forbidden edges between a  $g_5$  and a  $g_3$ , with  $\{\alpha, \beta\}$  in  $T$

(without the edge  $\{\alpha, \beta\}$ ). And if  $e$  links  $a$  and  $\beta$  (see the right part), then, still denoting by  $x, y$  and  $z$  the vertices in  $g_5$  other than  $a$  and  $\alpha$ , we can use Lemma 9: two watchers are sufficient to watch  $\{x, y, z\}$  and cover  $a$ , so that  $a$  and  $\alpha$  are now separated by a watcher. Thus, one watcher can be saved on  $g_5$ . We can now assume that  $\beta$  is linked to no gadget other than  $g_5$ .

Then the situation is described by Figure 47, with  $\alpha$  free in  $T'$ , and  $b \neq \beta$  or  $b = \beta$  in the left part (in the latter case, locate the watcher 3 at  $\beta$ ). When  $a$  is one extremity of  $e$ , we use Lemma 9 and save one watcher on  $g_5$ , so we are left with the case  $e = \{\alpha, b\}$  with  $b \neq \beta$  (see the right part of the figure), which is solved also using Lemma 9 and saving one watcher on  $g_3$ .

- (3) We finally study the case when there is one  $g_2$ , named  $g_2$ , with b. v.  $\alpha$  and ordinary vertex  $\alpha'$ , in the spanning tree  $T$ . The situation is now slightly different from the previous cases, because we may, without contradiction, have in  $G$  an edge between, for instance,  $\alpha'$  and a vertex of a  $g_3$ , since  $T$  may have been originally produced from  $K_5$  in  $G$ .

We consider in  $T$  a  $g_3$  named  $g_3$ , with b. v.  $\beta$ , and investigate which edge(s) can exist in  $G$  between  $g_2$  and  $g_3$ .

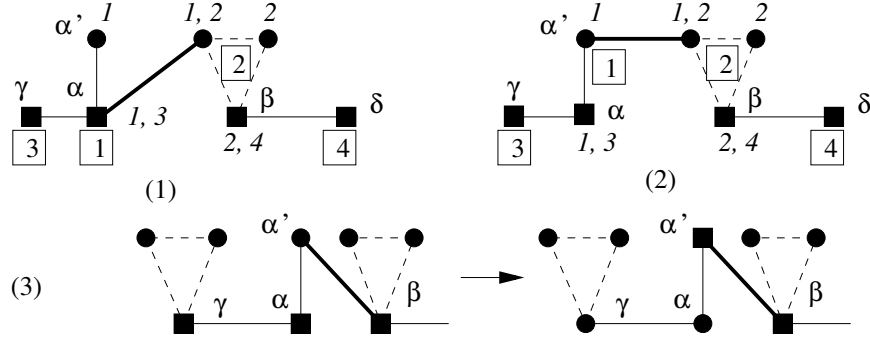

Figure 48: part (3) of Theorem 16: forbidden edges between a  $g_2$  and a  $g_3$

First, we assume that  $\{\alpha, \beta\}$  is not in  $T$ . Then in  $T$ ,  $\alpha$  is linked to the b. v.  $\gamma$  of a  $g_3$ , and  $\beta$  is linked to the b. v.  $\delta$  of a  $g_3$ , possibly with  $\gamma = \delta$ . Using Lemma 6, we locate watchers at  $\gamma$  and  $\delta$ , and Figure 48(1) and (2) shows how to routinely save one watcher on  $g_3$  when in  $G$  there is an edge between  $\alpha$  or  $\alpha'$  and an ordinary vertex of  $g_3$ , even if the watchers 3 and 4 coincide. Assume now that it is the edge  $\{\alpha', \beta\}$  which is in  $G$ . If in  $T$ , neither  $\alpha$  nor  $\gamma$  is connected to any  $g_3$ , we are in case (3) of Figure 48 and we consider that there is a  $g_5$  of type a or b in  $T$  rather than a  $g_2$ . So either  $\alpha$  or  $\gamma$  is connected to a  $g_3$ , with b. v.  $\phi$ . If  $\gamma \neq \delta$ , then  $\phi = \delta$  is possible, or (if  $\phi$  is not linked to  $\alpha$ )  $\phi = \beta$ ; if  $\gamma = \delta$ , then  $\phi = \beta$  is possible (if  $\phi$  is not linked to  $\alpha$ ). All this is depicted in Figure 49, where it can easily be seen how to save one watcher on  $g_2$  in all cases; we give only the full description of the last case, (e).

So we have just established that if  $\alpha$  is not connected to the b. v. of a  $g_3$ , then there exists no edge between this  $g_3$  and  $g_2$  in  $G$ . What happens now if  $\alpha$  is connected to the b. v.  $\beta$  of a  $g_3$ ,  $g_3$ , that is to say if there is the edge  $\{\alpha, \beta\}$  in  $T$ ? If in  $T$ ,  $\alpha$  is still linked to the b. v.  $\gamma$  of a  $g_3$  (with  $\gamma \neq \beta$ ) and  $\beta$  is still linked to the b. v.  $\delta$  of a  $g_3$  (with  $\gamma \neq \delta$  because there is no cycle in  $T$ ), we can re-run the argument used in the absence of  $\{\alpha, \beta\}$ : the first two cases of Figure 48 are exactly the same with or without  $\{\alpha, \beta\}$ , and in the third case, we have the edges  $\{\alpha', \beta\}$  and  $\{\alpha, \beta\}$  in  $G$ , from which we can still pick a spanning tree with a  $g_5$ ; and, because  $\phi \neq \beta$  and  $\phi \neq \delta$ , Figure 49 reduces to its first case (a), which can be treated similarly. Therefore, in  $T$ , either  $\alpha$  is not linked to the b. v. of any  $g_3$  other than  $\beta$ , or  $\beta$  is not linked to the b. v. of any  $g_3$ .

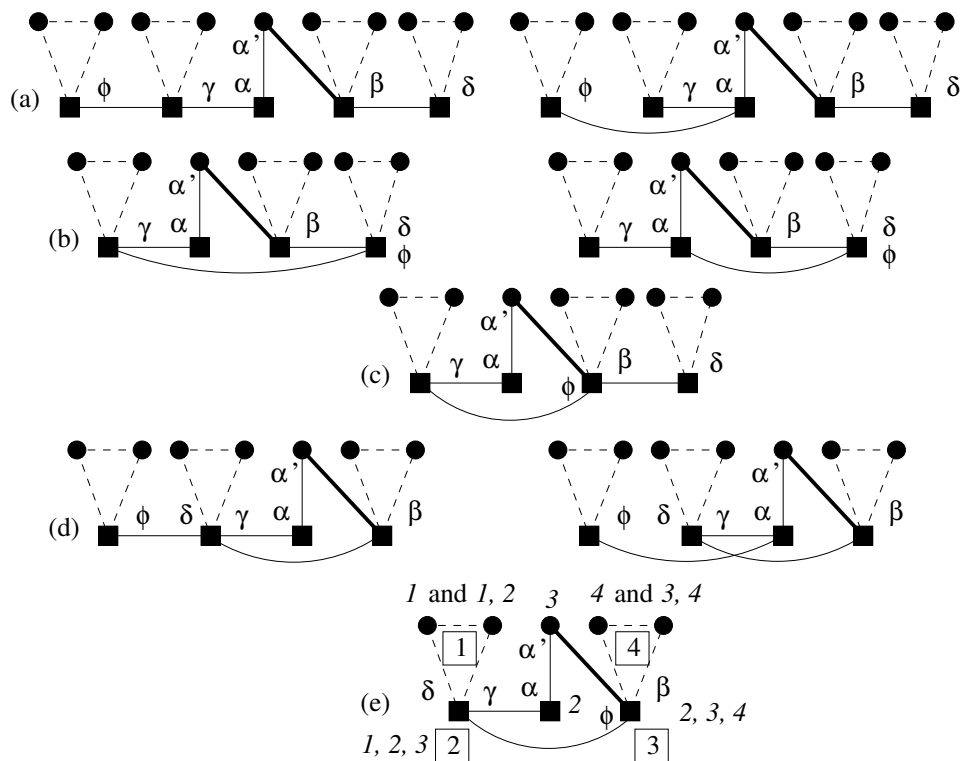

Figure 49: part (3) of Theorem 16, with the edge  $\{\alpha, \beta\}$  not in  $T$ : (a)  $\gamma \neq \delta$ ,  $\phi \neq \delta$ ,  $\phi \neq \beta$ ; (b)  $\gamma \neq \delta$ ,  $\phi = \delta$ ; (c)  $\gamma \neq \delta$ ,  $\phi = \beta$ ; (d)  $\gamma = \delta$ ,  $\phi \neq \beta$ ; (e)  $\gamma = \delta$ ,  $\phi = \beta$ .



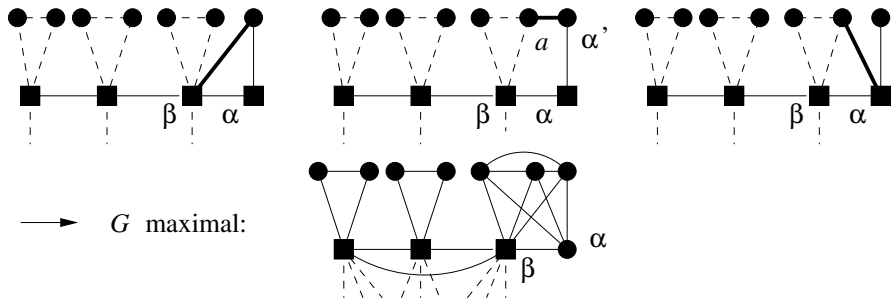

Figure 50: part (3) of Theorem 16, possible edges between a  $g_2$  and a  $g_3$ : actually, edges inside  $K_5$

If in  $T$ ,  $\alpha$  is linked to  $\beta$  only, then we have seen that no edge exists in  $G$  between  $g_2$  and any  $g_3$  other than  $g_3$ . But edges can exist between  $g_2$  and  $g_3$ , and indeed, we can add all the missing edges between these two gadgets, plus the missing edge in each  $g_3$ , plus all the missing edges between the b. v.'s of  $T$ , the number of needed watchers remains equal to  $2k + 1$ , and we have obtained the only maximal graph containing  $T$ , which is of the form described in the theorem; see Figure 50. Note that in some cases, the argument of the choice of a  $g_5$  in  $T$  can also be used, for instance if  $g_3$  is of type b and there is the edge  $\{a, \alpha'\}$ .

If  $\beta$  is linked only to  $\alpha$  and if  $\beta$  is the only b. v. which is linked only to  $\alpha$ , then any  $g_3$  other than  $g_3$ , with b. v.  $\gamma$ , can be linked to  $g_2$  uniquely through the edge  $\{\alpha, \gamma\}$ , and so in  $G$ , the possible edges between the ordinary vertex  $\alpha'$  of  $g_2$  and a  $g_3$  must affect  $g_3$  only. In the first two cases in Figure 51, a  $g_5$  should have been taken when choosing  $T$ , or, as in the third case and as in the previous figure, we can add all the edges between  $g_2$  and  $g_3$  and obtain  $K_5$ . So we are left with the case when there are two (or more)  $g_3$ 's with b. v.'s linked only to  $\alpha$  in  $T$ , see Figure 52(a). If in  $G$  there is the edge  $\{\alpha', a\}$ ,  $\{\alpha', b\}$  or  $\{\alpha', \beta\}$ , then again a spanning tree with a  $g_5$  could have been chosen, and if there is the edge  $\{\alpha, a\}$  or  $\{\alpha, b\}$  and neither  $\{\alpha, c\}$  nor  $\{\alpha, d\}$ , we can add to  $T$  all the edges between  $g_2$  and  $g_3$  in order to obtain  $K_5$  in a maximal graph. So the only possibility not ruled out yet is if there are the edges, say,  $\{\alpha, b\}$  and  $\{\alpha, c\}$  (more edges in  $G$  can only help). Then Figure 52(b) shows how to save (at least) one watcher, by locating two watchers at  $\alpha$ .

Now we are in a position to conclude. If in  $T$  there are edges between ordinary vertices of different gadgets or between the b. v. of a gadget and

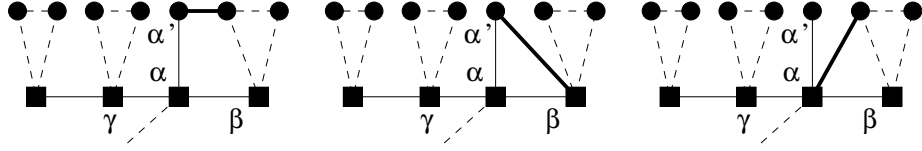

Figure 51: part (3) of Theorem 16:  $\beta$  is the only binding vertex linked only to  $\alpha$

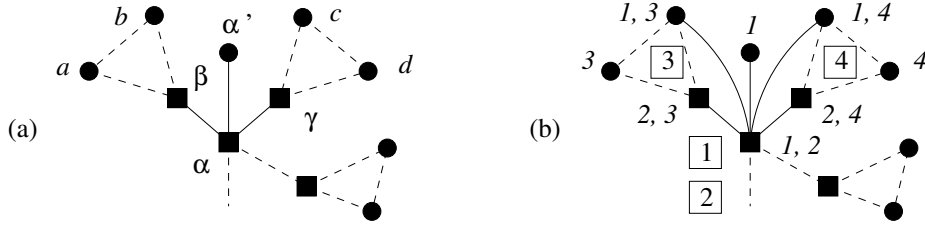

Figure 52: part (3) of Theorem 16: the binding vertices of (at least) two  $g_3$ 's are connected only to  $\alpha$

an ordinary vertex of another gadget, then another spanning tree should have been chosen, containing a  $g_5$  instead of a  $g_2$ , or containing a  $g_2$  with binding vertex of higher degree, or these edges are part of  $K_5$ , or we can save watchers.

Furthermore, if we add to  $T$  the missing edge on each  $g_3$ , the missing edges on the possible  $g_5$ , and all the missing edges between the b. v.'s in  $T$ , the number of needed watchers remains equal to  $2k+1$ : we have obtained the only maximal graph containing  $T$ . The proof of Theorem 16 is completed.  $\square$

The proof of the previous theorem, for  $n = 3k + 2$ , is not very encouraging in view of the case  $n = 3k + 1$ . Indeed, although we have some insight into the situation, we can only give the following proposition and conjecture, in which, to describe the graphs, we need three new gadgets of order 7 (which are not trees), with one or two binding vertices, see Figure 53. A  $g_7$  denotes a gadget of order 7. Unlike the  $g_4$ 's, the rightmost  $g_7$  of the figure must have each of its two binding vertices connected to other b. v.'s in the following statement.

**Proposition 17** *Let  $k$  be an integer,  $k \geq 6$ , and  $G$  be a graph of order  $3k + 1$  obtained by*

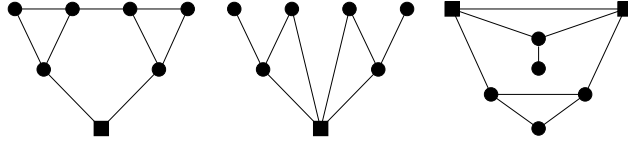

Figure 53: the three new gadgets of order 7

- (i) taking two  $K_2$ 's and  $k - 1$   $K_3$ 's,
- (ii) or taking one  $K_2$ , one  $K_5$  and  $k - 2$   $K_3$ 's,
- (iii) or taking two  $K_5$ 's and  $k - 3$   $K_3$ 's,
- (iv) or taking one  $K_4$  and  $k - 1$   $K_3$ 's,
- (v) or taking one  $g7$  and  $k - 2$   $K_3$ 's,

choosing one vertex named a binding vertex on each of the complete components  $K_i$ , except on  $K_4$  for which we choose two binding vertices, taking for the  $g7$  one or two binding vertices according to its type, and connecting these binding vertices to form a complete graph with them.

Then  $w(G) = 2k$ .

**Proof.** The proof is straightforward and is left to the reader. □

### Conjecture 18

- (1) The graphs described in the previous proposition are maximal.
- (2) They are the only maximal graphs attaining the bound  $2k$ .

The graphs of Figure 54 are examples of graphs described in Proposition 17. They have order 19 and reach the bound  $\omega(19) = 12$ : (a) with one  $K_2$ , one  $K_5$  and four  $K_3$ 's; (b) with one  $K_4$  and five  $K_3$ 's; (c) with one  $g7$  and four  $K_3$ 's.

For  $n = 3k + 1$  with  $k \leq 5$ , there are maximal graphs needing  $2k$  watchers which are not of the form described in Proposition 17. We give a certified example for  $n = 16$  in Figure 55.

## References

- [1] D. Auger, I. Charon, O. Hudry, A. Lobstein, Systèmes de contrôle dans les graphes : une extension des codes identifiants, Rapport Interne Télécom ParisTech-2010D011, Paris, France, 40 pages, 2010 (in English).

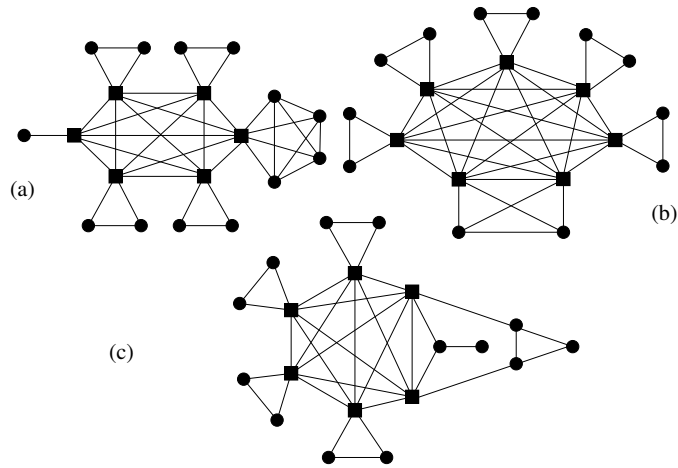

Figure 54: three graphs reaching the bound  $\omega(19) = 12$

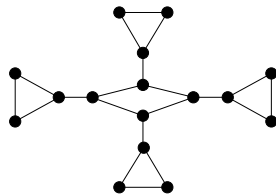

Figure 55: a maximal graph reaching the bound  $\omega(16) = 10$

- [2] D. Auger, I. Charon, O. Hudry, A. Lobstein, Watching systems in graphs: an extension of identifying codes, *Discrete Applied Math.*, to appear.
- [3] I. Charon, O. Hudry, A. Lobstein, Extremal cardinalities for identifying and locating-dominating codes in graphs, Rapport interne Télécom Paris-2003D006, Paris, France, 18 pages, 2003.
- [4] F. Foucaud, E. Guerrini, M. Kovše, R. Naserasr, A. Parreau, P. Valicov, Classifying graphs with minimum identifying code of size  $n-1$ , *Abstracts of the 8th French Combinatorial Conference*, Orsay, France, No. 151, 2010.
- [5] F. Foucaud, E. Guerrini, M. Kovše, R. Naserasr, A. Parreau, P. Valicov, Extremal graphs for the identifying code problem, *Europ. J. Combin.* **32** (2011), 628–638.
- [6] S. Gravier, J. Moncel, On graphs having a  $V \setminus \{x\}$  set as an identifying code, *Discrete Math.* **307** (2007), 432–434.
- [7] I. Honkala, A. Lobstein, On identification in  $Z^2$  using translates of given patterns, *J. Universal Comput. Sci.* **9(10)** (2003), 1204–1219.
- [8] M. G. Karpovsky, K. Chakrabarty, L. B. Levitin, On a new class of codes for identifying vertices in graphs, *IEEE Trans. Inform. Theory* **44** (1998), 599–611.
- [9] <http://www.infres.enst.fr/~lobstein/bibLOCDOMetID.html>
- [10] P. Rosendahl, On the identification of vertices using cycles, *Electron. J. Combin.* **10(1)** (2003), R7.
- [11] N. J. A. Sloane, *A Handbook of Integer Sequences*, New York - San Francisco - London: Academic Press, 1973.
- [12] N. J. A. Sloane, The On-Line Encyclopedia of Integer Sequences, <https://oeis.org/A000055>