



HAL
open science

Experimental measurement and numerical simulation of horizontal-coupled Slinky Ground Source Heat Exchangers

Yupeng Wu, Guohui Gan, Anne Verhoef, Pier Luigi Vidale, Raquel Garcia
Gonzalez

► **To cite this version:**

Yupeng Wu, Guohui Gan, Anne Verhoef, Pier Luigi Vidale, Raquel Garcia Gonzalez. Experimental measurement and numerical simulation of horizontal-coupled Slinky Ground Source Heat Exchangers. Applied Thermal Engineering, 2010, 30 (16), pp.2574. 10.1016/j.applthermaleng.2010.07.008 . hal-00675408

HAL Id: hal-00675408

<https://hal.science/hal-00675408>

Submitted on 1 Mar 2012

HAL is a multi-disciplinary open access archive for the deposit and dissemination of scientific research documents, whether they are published or not. The documents may come from teaching and research institutions in France or abroad, or from public or private research centers.

L'archive ouverte pluridisciplinaire **HAL**, est destinée au dépôt et à la diffusion de documents scientifiques de niveau recherche, publiés ou non, émanant des établissements d'enseignement et de recherche français ou étrangers, des laboratoires publics ou privés.

Accepted Manuscript

Title: Experimental measurement and numerical simulation of horizontal-coupled Slinky Ground Source Heat Exchangers

Authors: Yupeng Wu, Guohui Gan, Anne Verhoef, Pier Luigi Vidale, Raquel Garcia Gonzalez

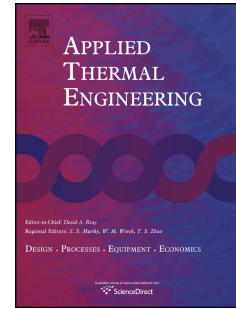

PII: S1359-4311(10)00291-7

DOI: [10.1016/j.applthermaleng.2010.07.008](https://doi.org/10.1016/j.applthermaleng.2010.07.008)

Reference: ATE 3167

To appear in: *Applied Thermal Engineering*

Received Date: 19 March 2010

Revised Date: 7 July 2010

Accepted Date: 8 July 2010

Please cite this article as: Y. Wu, G. Gan, A. Verhoef, P.L. Vidale, R.G. Gonzalez. Experimental measurement and numerical simulation of horizontal-coupled Slinky Ground Source Heat Exchangers, *Applied Thermal Engineering* (2010), doi: 10.1016/j.applthermaleng.2010.07.008

This is a PDF file of an unedited manuscript that has been accepted for publication. As a service to our customers we are providing this early version of the manuscript. The manuscript will undergo copyediting, typesetting, and review of the resulting proof before it is published in its final form. Please note that during the production process errors may be discovered which could affect the content, and all legal disclaimers that apply to the journal pertain.

Experimental measurement and numerical simulation of horizontal-coupled Slinky Ground Source Heat Exchangers

Yupeng Wu^{a*}, Guohui Gan^a, Anne Verhoef^b, Pier Luigi Vidale^c and Raquel Garcia Gonzalez^b

^aDepartment of the Built Environment, Faculty of Engineering, University of Nottingham, Nottingham NG7 2RD, UK

^bDepartment of Soil Science, School of Human and Environmental Sciences, University of Reading, Reading RG6 6DW, UK

^cNCAS-Climate, Department of Meteorology, University of Reading, Reading RG6 6BB, UK

*Corresponding author: Tel: +44 (0)1158467312;

Emails: Yupeng.Wu@nottingham.ac.uk, jackwuyp@googlemail.com

Abstract

Results from both experimental measurements and 3D numerical simulations of Ground Source Heat Pump systems (GSHP) at a UK climate are presented. Experimental measurements of a horizontal coupled slinky GSHP were undertaken in Talbot Cottage at Drayton St Leonard site, Oxfordshire, UK. The measured thermophysical properties of in-situ soil were used in the CFD model. The thermal performance of slinky heat exchangers for the horizontal-coupled GSHP system for different coil diameters and slinky interval distances was investigated using a validated 3D model. Results from a two month period of monitoring the performance of the GSHP system showed that the COP decreased with the running time. The average COP of the horizontal coupled GSHP was 2.5. The numerical prediction showed that there was no significant difference in the specific heat extraction of the slinky heat exchanger at different coil diameters. However, the larger the diameter of coil, the higher the heat extraction per meter length of soil. The specific heat extraction also increased, but the heat extraction per meter length of soil decreased with the increase of coil central interval distance.

Key words: Ground source heat pump; horizontal-coupled; slinky; specific heat extraction

1. Introduction

To reduce dependence on fossil fuel energy resources and environmental degradation resulting from their combustion, renewable energy sources must play an increasingly significant role. Geothermal energy, one of the renewable energy resources, can be used to provide electricity, heating and cooling for buildings. Shallow Ground Source Heat Pump systems (GSHP) which make use of the relatively constant temperature of the earth are mainly used for space conditioning. However, the installation of the ground Heat Exchanger (HE) is costly, which is one of the main causes preventing the wide adoption of the GSHPs in the UK. Therefore, the horizontal-coupled ground source heat pump has become increasingly important. It can reduce installation cost compared to that of other GSHP systems as no drilling is necessary and only a trench 1 to 2 m in depth is required. Nevertheless, A single tier ground loop requires a large area of ground to lay the pipe network. This problem can be alleviated to some extent by employing double tier pipe arrangement or slinky ground loop. A slinky ground loop requires horizontal trench lengths of 20-30% of those for a horizontal coupled single pipe configuration, however the thermal performance of the slinky ground loop may be doubled. A first recorded slinky heat exchanger coupled GSHP system was developed by Bose and Smith [1] at Oklahoma State University. They indicated that the slinky heat exchanger enhanced the heat transfer area within a limited space when compared to a horizontal buried heat exchanger.

The performance of a heat pump is usually expressed in terms of its Coefficient Of Performance (COP) which is the ratio of energy output to supplied energy (electricity for the

1 compressor, pump etc) of GSHP. COPs in the heating and cooling mode are identified by
2 COP_h and COP_c , respectively. A typical heat pump has a COP of around 4 which indicates
3 that the heat pump produces four units of heating energy for every unit of electrical energy
4 input. The COP of the GSHP depends on the soil type at the installation, etc. Research has
5 been carried out to determine the performance of horizontal-coupled GSHP. Metz [2] used a
6 horizontal-coupled GSHP to provide heating and cooling for a 104m² house in Long Island,
7 New York. During a period of one year monitoring, the obtained average COP_h and COP_c of
8 the GSHP system were 2.46 and 1.91, respectively. İnallı and Esen [3] carried out
9 experimental measurements of a GSHP system with horizontal-coupled heat exchanger in
10 selected depths of 1 and 2m in Elaziğ, Turkey. After running the GSHP for heating from
11 November 2002 to April 2003 for a room with 16.24m² floor area, the obtained average
12 COP_h of the GSHP system was 2.66 and 2.81 for the heat exchanger buried at depths of 1m
13 and 2m, respectively. Doherty et al [4] installed and undertook experimental measurements of
14 a horizontal slinky GSHP system in the University of Nottingham, UK. An average COP_h of
15 approximately 2.7 was reported. Coşkun et al [5] studied the performance of a horizontal
16 ground source compression refrigeration system in Bursa city, Turkey. The horizontal
17 coupled heat exchanger was buried at a depth of 2.0m. The COP_c of the overall system varied
18 between 2 and 2.5.

19 Research has also been undertaken for the horizontal-coupled GSHP systems by other
20 investigators including the experimental characterisations of the thermal performance of the
21 horizontal coupled heat exchanger and different approaches to enhance the heat transfer
22 between the heat exchanger and the soil [6-11]. Florides and Kalogirou [12] reviewed the
23 performance and numerical model of ground-coupled heat exchangers. They indicated that
24 the ambient climatic conditions would affect the temperature profile below the ground
25 surface and this should be considered when designing a horizontal coupled heat exchanger. In
26 the UK, most of the recent studies of the horizontal coupled GSHP were focused on the heat
27 pump output to maintain daily indoor air temperature [13-16]. Few studied the long term
28 effect of horizontal-coupled heat exchanger on the ground temperature, which is vital for
29 correct sizing of heat pumps to achieve an accurate prediction of their long term performance
30 over their useful working life. In this work, the performance of a horizontal coupled slinky
31 GSHP installed in the UK was monitored and measured results were used to validate a CFD
32 model. The validated model was then used to predict the thermal performance of ground
33 coupled slinky heat exchangers for different slinky diameters and slinky interval distances.

34 **2. Experimental measurements**

35 **2.1 Experimental apparatus installation**

36 Experimental measurements were carried out at Talbot Cottage, Drayton St Leonard site,
37 Oxfordshire, UK where 4 parallel horizontal-coupled slinky Heat Exchanger loops were
38 installed in a 80m long by 20m wide paddock area at a depth of around 1.2m below the
39 ground surface. Figure 1 shows an image for one of the loops. The fluid in the heat exchanger
40 was water-ethylene glycol (30% by weight) mixture. The ground surface was overgrown with
41 wild flowers. Soft sand was used below and on top of the slinky heat exchanger.

42 To monitor the soil temperature distribution and also the performance of the horizontal-
43 coupled heat exchanger, two holes were dug in the ground to install thermistors at various
44 depths. One hole was dug above a portion of the ground coupled heat exchanger, the second
45 hole served as a reference hole dug at a distance of around 2m from the other hole and with
46 no heat exchanger installed around it. After installing the sensors, all the holes were refilled
47 with the original soil. Monitoring started 1 month after switching on the GSHP system. A
48 sketch of the positions of the sensors used to monitor the soil and the heat exchanger thermal

1 performance with detailed sensor positions is shown in Figure 2. T-type thermocouples were
2 installed at the inlet and outlet of the ground coupled heat exchangers to monitor the thermal
3 energy extracted by the ground coupled slinky heat exchanger. Simultaneously, a mini
4 weather station was installed to monitor the ambient air temperature, wind speed, global solar
5 radiation, relative humidity and rain fall. All the sensors were calibrated before installation.

6 **2.2 Analysis of experimental results**

7 The sensor readings were taken every 30mins. Ambient air temperature and soil temperatures
8 above a portion of heat exchanger and in the reference hole for a period of around two
9 months from 6th Nov 2009 to 31st Dec 2009 are shown in Figures 3. The measured soil
10 temperature at a depth of 0.25m had a similar characteristic to ambient air temperature. There
11 were short term strong and irregular fluctuations of temperature, caused by the daily change
12 of weather conditions. However, the temperature fluctuation ceased at a larger depth, below
13 the depth of 0.5m, the temperature fluctuations were hardly discernible. It can be seen that
14 soil with and without heat exchanger below had a similar temperature variation pattern at the
15 same depth. However, the soil temperatures with a heat exchanger installed below were lower
16 than those of the soil in the reference hole without heat exchanger under it. With the soil
17 depth increase, the soil temperature increased without heat exchanger below it, whereas the
18 soil temperature decreased where the heat exchanger was installed below it. This is due to the
19 thermal energy being extracted by the heat exchanger. At a depth of 0.02m below the ground
20 surface, there were no significant temperature differences for the soil with and without heat
21 exchanger below them. Around 20th Dec 2009, the soil without heat exchanger installed
22 below had a higher temperature of around 2°C than that with heat exchanger installed below.
23 This deviation may be caused by the different soil physical properties or the heat exchanger.
24 At a larger depth, the temperature difference between the soil with and without heat
25 exchanger installed was larger. The temperature difference at a depth of 0.5m was around
26 1.5°C, and 3°C at a depth of 1m.

27 The ground temperature distribution was analysed in more detail for two different days-7th
28 Nov and 28th Dec 2009. It was sunny on 7th Nov 2009, and a partly cloudy day and the
29 ground was covered by snow on 28th Dec 2009. The measured solar radiation intensity,
30 ambient air temperature and wind speed for the two days are shown in Figure 4(a). The
31 measured solar radiation intensity on 7th Nov. 2009 was significantly higher than that on
32 28th Dec. 2009. The highest solar radiation intensity was around 350W/m² on 7th Nov 2009
33 and approximately 150W/m² on 28th Dec 2009. The measured ambient temperature was also
34 higher on 7th Nov 2009. The measured average wind speed was around 1 and 2m/s on 7th
35 Nov and 28th Dec 2009, respectively.

36 The various ground surface temperatures with ambient air temperature are shown in Figure
37 4(b), and the ground temperature distribution above the heat exchanger and without heat
38 exchanger installed below on 7th Nov 2009 is illustrated in Figure 5. From Figures 4(b) and 5,
39 it can be seen that the soil with and without heat exchanger installed, their surface
40 temperature had a similar characteristic to the ambient air temperature on that day, however,
41 the ground surface temperature was slightly higher with no heat exchanger installed below.
42 This might be caused by different soil physical properties. They all decreased in the night
43 from 00:00 to 8:00 due to convective and long wave radiative heat losses, and reached the
44 lowest value of around 3°C of the day at 8:00 in the morning, and then increased to around
45 13.5°C (no HE) and 11.5°C(HE installed), respectively at noon. After 13:30 they all began to
46 decrease due to the reduced solar radiation intensity. Because the thermal energy in the
47 ground was extracted by the heat exchanger, the soil temperature varied between 7 and 8°C at
48 a depth of around 1.14m below the ground. The environmental conditions influenced the soil

1 temperature up to a depth of around 0.5m. It can also be seen that at the same depth of around
2 1m from the ground surface, the soil with no heat exchanger installed below had a constant
3 temperature around 11°C for the whole day, which was over 3°C higher than the soil
4 temperature with heat exchanger installed below. At a depth of 0.25m from the ground
5 surface, the soil without heat exchanger installed below had a temperature around 1°C higher
6 than that with heat exchanger installed below. It can be concluded that the extraction of
7 thermal energy by the heat exchanger affected the soil temperature at a distance of around
8 0.9m from the heat exchanger during the operation period.

9 Figure 6 illustrates ground temperature distribution above the heat exchanger and ground
10 temperature distribution in the reference hole on 28th Dec 2009. From Figures 4(b) and 6, it
11 can be seen that the soil at a depth of 0.02m had a temperature around 0°C for the whole day,
12 because the ground surface was covered with approximately 0.05m thick snow, which
13 prevented the radiative and convective heat loss, and also the chance to absorb the diffused
14 solar radiation at the ground surface. Its temperature was higher than the ambient air
15 temperature at the same time. At a depth of around 1.0 m from the ground surface, the soil
16 with no heat exchanger below had a constant temperature around 5°C for the whole day, it
17 was approximately 2.5°C higher than that of the soil with heat exchanger installed below. At
18 a depth of 0.1m from the ground surface, the soil with no heat exchanger below had a
19 temperature around 0.5°C higher than that with heat exchanger installed below, similar to
20 characteristics of the soil temperature distribution found on 7th Nov 2009.

21 Figure 7 illustrates the measured inlet and outlet fluid temperatures of the ground coupled
22 heat exchanger. The temperatures of the inlet and outlet of the heat exchanger significantly
23 decreased with time. However, there were no significant change in temperature difference
24 between the inlet and outlet. The GSHP system had been continuously running for nearly two
25 month by the time (nearly 24 hours a day). Only for a few hours (less than 1 hour a week),
26 the temperature difference dropped to approximately 1°C from 2°C during a two month
27 operation, because the GSHP system stopped running, and the inlet temperature for the heat
28 exchanger began to increase for a short period. The calculated COP of the ground source heat
29 pump system is shown in Figure 8. It can be seen that the system COP decreased slightly with
30 the time from 6th Nov 2009 to 31st Dec 2009. It was around 2.7 on 6th Nov 2009, and
31 decreased to approximately 2.5 on 31st Dec 2009.

32 **2.3 Measurement of site soil properties**

33 Three soil samples at depths of around 0.2, 0.8 and 1m below the ground surface at the test
34 site were taken to the lab at the Department of Built Environment, University of Nottingham
35 using 50mm deep by 50mm inner diameter aluminium cylinder tins. The thermal
36 conductivity, thermal capacity, density and volumetric moisture content of the in situ
37 undisturbed soil were measured using the following facilities

- 38 • KD2 pro used to measure the thermal conductivity and capacity,
- 39 • A thermostatically controlled oven, capable of maintaining a temperature between
40 105 and 110°C,
- 41 • A balance readable and accurate of 0.01g

42 The measured thermophysical properties of the soil samples are shown in Table 1. The
43 measured thermophysical properties varied at different depths. The thermal conductivity and
44 density were higher for the soil near the ground surface and heat exchanger than in the middle

1 but the soil thermal capacity and the volumetric moisture content decreased with the depth.
2 Average thermophysical properties were used in the numerical prediction.

3. Numerical prediction

4 A commercial CFD software package FLUENT was used to predict the thermal performance
5 of a portion of the horizontal coupled slinky and straight heat exchangers. The transient 3
6 dimensional sensible heat transfer model for the ground coupled heat exchanger is as follows:

$$7 \quad \frac{\partial(\rho T)}{\partial t} + \nabla \cdot (\rho \bar{V} T - \frac{k}{c} \nabla T) = \frac{q}{c} \quad (1)$$

8 where ρ is the density (kg/m^3), t is the time (s), T is the temperature (K), V is the fluid flow
9 velocity (m/s), k is the thermal conductivity (W/mK), c is the specific heat (J/kgK) and q is
10 the heat source (W/m^3).

11
12 The model was validated using the experimentally measured results using the method
13 described below. The measured environmental conditions at 00:00 7th Nov 2009 were used
14 as the initial conditions for the model. The predicted and the measured soil temperature
15 distributions at selected times are shown in Figure 9. It can be seen that the predictions
16 generally agreed with the experimental measurements. The maximum difference between the
17 predicted and measured soil temperatures was less than 1°C , which was found near the
18 ground surface. This might be the result of using constant and uniform soil thermophysical
19 properties in the model, whereas the soil thermophysical properties might not be uniform
20 particularly near the surface.

21 The thermal performance of a portion of a horizontal coupled slinky and straight heat
22 exchangers was predicted using the validated CFD model. Comparisons of thermal
23 performances of the slinky heat exchanger at different slinky (coil) diameters and different
24 slinky (coil) interval distance were also conducted. The measured average thermophysical
25 properties of the in situ soil detailed in section 2.3 were used in the numerical model. In the
26 predictions, it was assumed that the horizontal-coupled straight and slinky heat exchangers
27 were buried at a depth of 1.2m in the ground as illustrated in Figure 10. Due to a large
28 number of meshes required to model the 3D transient heat transfer, only half of the slinky
29 heat exchanger was applied in the model and a symmetric surface was defined at the vertical
30 central surface as shown in Figure 10(b).

31 Further assumptions used to simplify the model were as follows,

- 32 • For a short length of the heat exchanger, the pipe outer surface temperature was
33 assumed constant at 1°C for heating mode. Prediction of the thermal performance of
34 the heat exchanger with similar dimension and environmental conditions with 1°C
35 refrigerant fluid flow at the inlet of the heat exchanger was also undertaken, and the
36 results showed that after running the system for more than 140 hours, there was no
37 significant difference in the temperature distribution in the soil or the specific heat
38 extraction between the conditions with fixed pipe temperature and fluid flow inside
39 the heat exchanger,
- 40 • A constant temperature of 10°C was utilised at a depth of 4m from the ground surface
41 for a short period of operating the GSHP,
- 42 • The soil thermal properties (soil thermal conductivity and diffusivity) were constant
43 and uniform,
- 44 • The wind speed was 3m/s on the ground surface with an ambient air temperature of
45 5°C .

1 **3.1 Predicted thermal performance of the horizontal-coupled straight and slinky heat** 2 **exchanger**

3 Isotherms generated from prediction for the horizontal-coupled straight and slinky heat
4 exchanger at the elapsed time of 1 and 50hours are shown in Figures 11 and 12, respectively.
5 For the horizontal-coupled straight heat exchanger, after running the system for 1 hour, the
6 temperature of the soil around the heat exchanger decreased to 1°C. The temperature of the
7 soil decreased at a distance within 0.1m from the central long axis of the heat exchanger, due
8 to the thermal energy being extracted by the heat exchanger. At 50 hours, the heat exchanger
9 affected the temperature of the soil within a distance of around 0.6m from the central long
10 axis of the heat exchanger. With further running of the system, the soil temperature
11 continuously decreased, due to the convective heat loss from the soil to the ambient air and
12 heat extraction by the heat exchanger. The slinky heat exchanger and its surrounding soil had
13 similar thermal characteristics as that for the straight heat exchanger under similar conditions.
14 However, the temperature of the soil within a distance of around 0.8m from the central long
15 axis of the heat exchanger was influenced by the heat exchanger, it was larger than that of the
16 single straight heat exchanger system. This is because the slinky system comprised of a
17 straight and coil heat exchangers with a small portion of the heat exchanger being in parallel
18 located.

19 A parameter used to calculate the required length of borehole heat exchangers is the specific
20 heat extraction, expressed in Watt per meter length. Typical values are in the range from 40
21 to 70W/m for borehole heat exchangers, dependent on soil thermal conductivity, heat pump
22 annual operation hours, number of neighbouring boreholes, etc [17]. The variation of the
23 predicted specific heat extraction with time for a portion of the horizontal-coupled straight
24 and slinky heat exchangers, and the difference of the specific heat extraction between the two
25 systems are illustrated in Figure 13. It can be seen that the specific heat extraction for both
26 the horizontal-coupled straight and slinky heat exchangers was approximately at 46W/m
27 initially, decreased to approximately 33 and 30W/m respectively after continuously running
28 the GSHP system for 10hours, and further decreased to around 18 and 15W/m after running
29 the GSHP system for 140hours. Thus, it can be concluded that the difference of the specific
30 heat extraction between the straight and the slinky heat exchangers increased with running
31 time. It was around 1.5W/m for the first hour, and increased to around 3W/m at 140hour. The
32 predicted specific heat extraction was lower than that commonly used for designing GSHPs.
33 If the total length of the heat exchanger was estimated from the over optimistic value of the
34 specific heat extraction, the output and COP of the heat pump would be lower than expected.

35 The variation of the heat extraction per meter length of the soil occupied by heat exchangers
36 is illustrated in Figure 14. Although the specific heat extraction of the slinky heat exchanger
37 was lower than that of the straight one, the heat extraction per meter length of the soil for the
38 slinky heat exchanger was significantly higher than that of the straight heat exchanger. At the
39 beginning, the difference between the slinky and straight heat exchanger was about 45W per
40 meter length of soil, and decreased to approximately 12W per meter length of soil after
41 running the simulation for 140hours.

42 **3.2 Effect of the coil diameter on the thermal performance of the slinky heat exchangers**

43 The thermal characteristics of the ground coupled slinky heat exchangers at different coil
44 diameters of 0.6, 0.8 and 1.0m were determined by running the transient state simulation for
45 the similar environmental conditions used in section 3.1. The dimensions of the domain and
46 the heat exchangers are shown in Table 2.

1 From the prediction, it was found that there was no significant difference of the specific heat
2 extraction of the slinky heat exchanger at different coil diameters of 0.6, 0.8 and 1.0m. This
3 might be because the horizontal-coupled straight part of the heat exchanger occupied over 50%
4 of the total length in the simulated slinky heat exchanger. Thus by changing the diameters of
5 the coil, there was no obvious differences of the specific heat extraction. However, the larger
6 the diameter of the coil, the higher the heat extraction per meter length of soil. The variation
7 of the heat extraction per meter length of the soil occupied by heat exchangers at different
8 coil diameters are illustrated Figure 15. At the beginning, the heat extraction per meter length
9 of soil was around 91W/m for the coil diameter of 1m, approximately 82W/m for the coil
10 diameter of 0.8m and 72W/m for the coil diameter of 0.6m. It decreased to approximately
11 30W/m with a coil diameter of 1m, around 27W/m with a coil diameter of 0.8m and
12 24.6W/m with a coil diameter of 0.6m at 140 hours.

13 **3.3 Effect of coil central interval distance on the thermal performance of the slinky heat** 14 **exchangers**

15 The thermal characteristics of the ground coupled slinky heat exchangers at different coil
16 central interval distance of 1.2, 1.6, 2.0 and 3.0m were predicted using the similar
17 environmental conditions used in sections 3.1 and 3.2.

18 The variation of the specific heat extraction for the slinky heat exchangers and the variation
19 of the heat extraction per meter length of the soil occupied by heat exchangers at different
20 coil central interval distances are illustrated Figures 16 and 17, respectively. From the
21 prediction, it was observed that the specific heat extraction increased with the increase in the
22 coil central interval distance. At the beginning, the specific heat extraction was 44.6W/m for
23 a slinky with coil central interval distance of 3m, 44.2W/m for that at 2m, 44.0W/m at 1.6m
24 and 43.8W/m at 1.2m. At 140hours, the specific heat extraction decreased to 14.9W/m for a
25 slinky with coil central interval distance at 3m, 14.0W/m for that at 2m, 13.3W/m at 1.6m
26 and 11.8W/m at 1.2m. However, the heat extraction per meter length of soil for a slinky
27 decreased with the increase of coil central interval distance. At the beginning, the heat
28 extraction per meter length of soil was 158.4W/m for a slinky with coil central interval
29 distance of 1.2m, 130.5W/m for that at 1.6m, 113.7W/m at 2.0m and 91.3W/m at 3.0m. At
30 140hours, the heat extraction per meter length of soil decreased to 42.5W/m for a slinky with
31 coil central interval distance of 1.2m, 39.3W/m for that at 1.6m, 36.1W/m for that at 2.0m
32 and 30.5W/m at 3.0m

33 **4. Conclusions**

34 The thermal performance of horizontal-coupled slinky GSHP was determined both
35 experimentally and numerically in a UK climate. During a two month period of monitoring
36 the performance of the GSHP system, the COP of the GSHP decreased with the running time.
37 The average COP of the horizontal coupled GSHP was 2.5. To increase the COP of the
38 system, it required longer heat exchanger and a larger land area for heat exchanger
39 installation.

40 The thermal performance of a portion of slinky GSHP at different coil diameters and different
41 coil central interval distances was predicted using a validated 3D model. The performance of
42 slinky heat exchangers was also compared with that of straight heat exchangers. The specific
43 heat extraction for both the straight and slinky heat exchangers initially at 46W/m decreased
44 with increasing system running time but at different rates. After running the systems for
45 140hours, the specific heat extraction of the straight pipe would be 3.5W/m higher than that
46 of the slinky pipe. However, the heat extraction per meter length of soil for the slinky heat
47 exchanger was significantly higher than of the straight system. There was no significant

1 difference in the specific heat extraction of the slinky heat exchanger at different coil
2 diameters of 0.6, 0.8 and 1.0m. However, the larger the diameter of coil, the higher the heat
3 extraction per meter length of soil. The specific heat extraction also increased with the
4 increase in the coil central interval distances. On the other hand, the heat extraction per meter
5 length of soil for a slinky decreased with the increase of coil central interval distance.

6 Acknowledgements:

7 This work has been supported by the Natural Environment Research Council through the
8 funding of the project. Also, the authors would like to thank Mr Alan Johns for allowing us to
9 access the Ground Source Heat Exchanger used in this work.

10

11 References

- 12 [1] J. E. Bose and M. D. Smith, Performance of new ground heat exchanger configurations
13 for heat pump, *Solar Engineering*, 1 (1992)
- 14 [2] P. D. Metz, Ground coupled heat pump system experimental results, Report No. BNL-
15 33540, Brookhaven National Laboratory, Upton (1983)
- 16 [3] M. İnallı and H. Esen, Experimental thermal performance evaluation of a horizontal
17 ground source heat pump system, *Applied Thermal Engineering*, 24 (2004) 2219-2232.
- 18 [4] P. S. Doherty, S. Al-Huthaili, S. B. Riffat and N. Abodahab, Ground source heat pump-
19 description and preliminary results of the Eco House system, *Applied Thermal Engineering*
20 24 (2004) 2627-2641
- 21 [5] S. Coşkun, E. Pulat, K. Ünlü and R. Yamankaradeniz, Experimental performance
22 investigation of a horizontal ground source compression refrigeration machine, *International*
23 *Journal of Energy Research*, 32 (2008) 44-56.
- 24 [6] W. V. Jones, J. Taylor Beard, R. J. Ribando and Barry K. Wilhelm, Thermal performance
25 of horizontal closed-loop ground coupled heat pump systems using flowable-fill, (1996)
26 *Proceedings of the 1996 IECEC Meeting*, Washington, D.C.
- 27 [7] M. Piechowski, Heat and mass transfer model of a ground heat exchanger: validation and
28 sensitivity analysis, *International Journal of Energy Research*, 22 (1998) 965-979.
- 29 [8] M. Piechowski, Heat and mass transfer model of a ground heat exchanger: theoretical
30 development, *International Journal of Energy Research*, 23 (1999) 571–588.
- 31 [9] H. Esen, M. İnallı and M. Esen, Numerical and experimental analysis of a horizontal
32 ground- coupled heat pump system, *Building and Environment*, 42 (2007) 1126-1134.
- 33 [10] H. Demir, A. Koyun and G. Temir, Heat transfer of horizontal parallel pipe ground heat
34 exchanger and experimental verification, *Applied Thermal Engineering*, 29 (2009) 224-233.
- 35 [11] A. Koyun, H. Demir and Z. Torun, Experimental study of heat transfer of buried finned
36 pip for ground source heat pump applications. *International Communications in Heat and*
37 *Mass Transfer*, 36 (2009) 739-743.

- 1 [12] G. Florides and S. Kalogirou, Ground heat exchangers-A review of systems, models and
2 applications. *Renewable Energy* 32 (2007) 2461-2478.
- 3 [13] R. Rawlings, Ground Source Heat Pump: A technology review. Available from:
4 www.bsria.co.uk.
- 5 [14] H., Singh, A. Muetzeb and P.C. Eames, Factors influencing the uptake of heat pump
6 technology by the UK domestic sector. *Renewable Energy* 35 (2010) 873-878.
- 7 [15] Energy Saving Trust, Heat pumps in the UK - a monitoring report (2000 edition). GIR72,
8 London Available from: [http://www.energysavingtrust.org.uk/business/Global-](http://www.energysavingtrust.org.uk/business/Global-Data/Publications/Heat-Pumps-in-the-UK-a-monitoring-report-GIR72)
9 [Data/Publications/Heat-Pumps-in-the-UK-a-monitoring-report-GIR72](http://www.energysavingtrust.org.uk/business/Global-Data/Publications/Heat-Pumps-in-the-UK-a-monitoring-report-GIR72).
- 10 [16] Energy Saving Trust, Domestic ground source heat pumps: design and installation of
11 closed-loop systems (2007 edition), CE82/GPG339, London Available from:
12 www.est.org.uk/housingbuildings (2007).
- 13 [17] European Geothermal Energy Council, Ground source heat pump: A guide book. (2008).

Table 1 Measured thermophysical properties of the undisturbed soil samples from the site

	Sample 1 (Depth at 1m)	Sample 2 (Depth at 0.6m)	Sample 3 (Depth at 0.2m)	Average
Soil thermal conductivity (W/m K)	1.37	1.02	1.32	1.24
Soil thermal capacity (J/kg K)	1383.32	1420.27	1591.07	1464.88
Soil density (kg/m ³)	1598.70	1431.15	1733.01	1587.62
Soil volumetric moisture content (%)	22.69	24.79	30.74	26.07

Table 2 Dimensions of domain for selected models

Model dimension	Slinky (d=1m)	Slinky (d=0.8m)	Slinky (d=0.6m)
Width (m)	3	2.8	2.6
Length (m)	1.5	1.5	1.5
Depth (m)	4	4	4
Diameter of the heat exchanger(m)	0.04	0.04	0.04
Total length of the heat exchanger (m)	1.5(straight part) +1.57(coil part)	1.5(straight part) +1.256(coil part)	1.5(straight part) +0.942(coil part)



Figure 1 Image of the horizontal-coupled ground source heat exchanger at Talbot Cottage, Drayton St Leonard site, Oxfordshire, UK

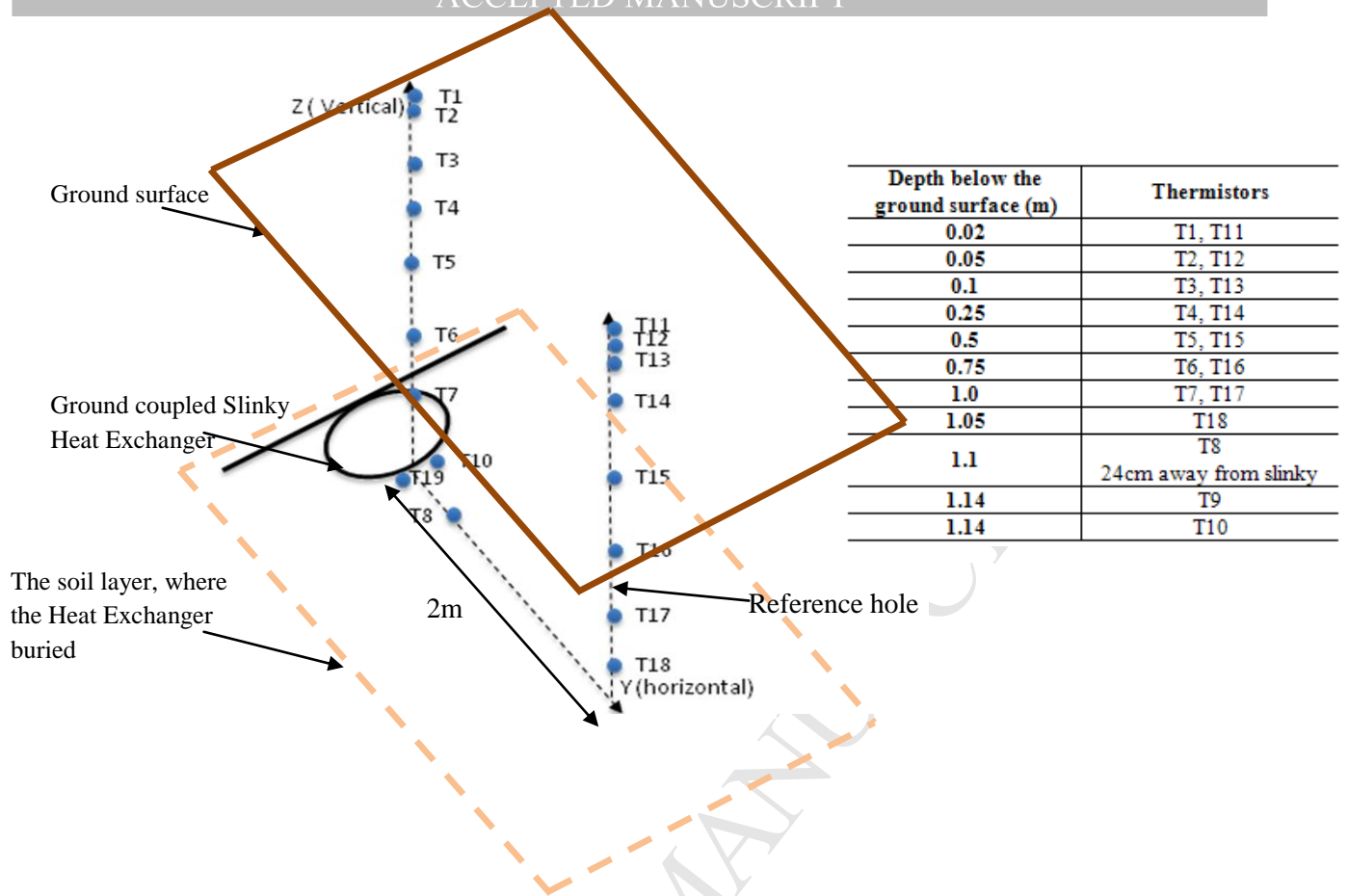
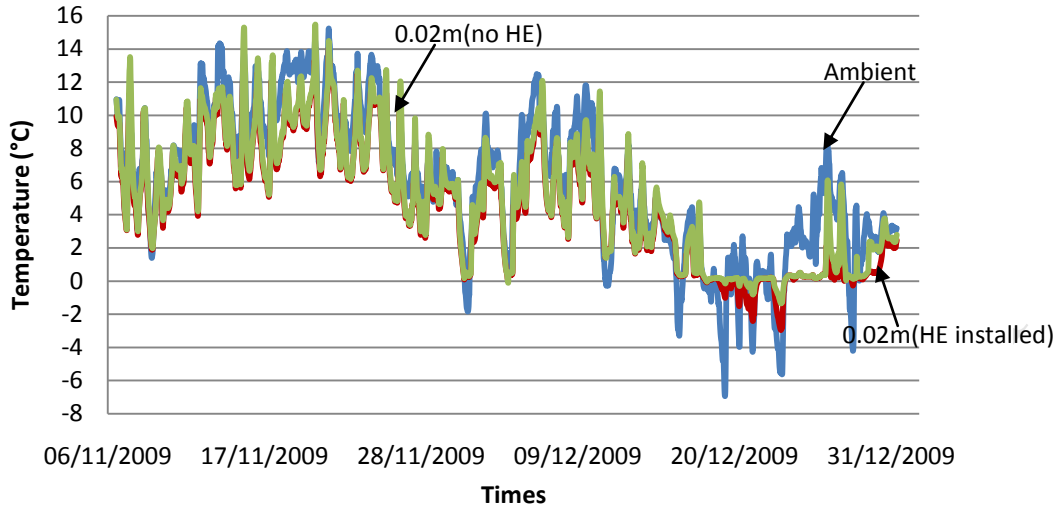
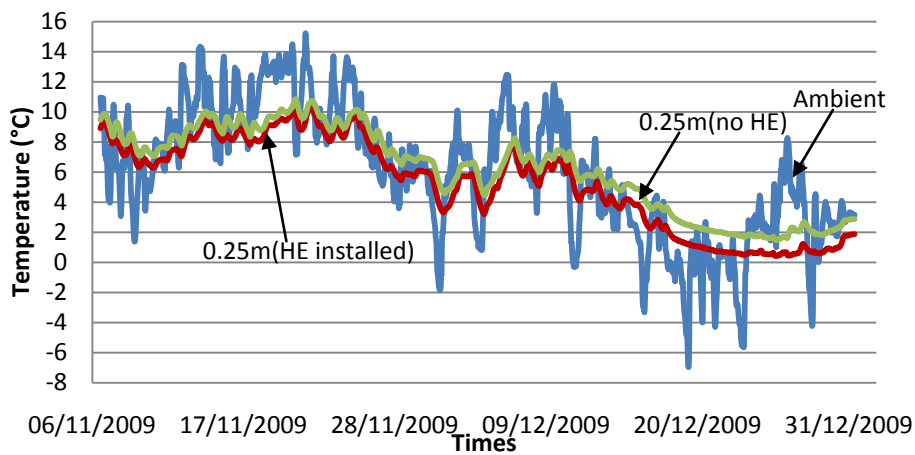

Figure 2 3D sketch of the sensor positions used to measured the slinky and the soil thermal performance



(a) At a depth of 0.02m below the ground surface



(b) At a depth of 0.25m below the ground surface

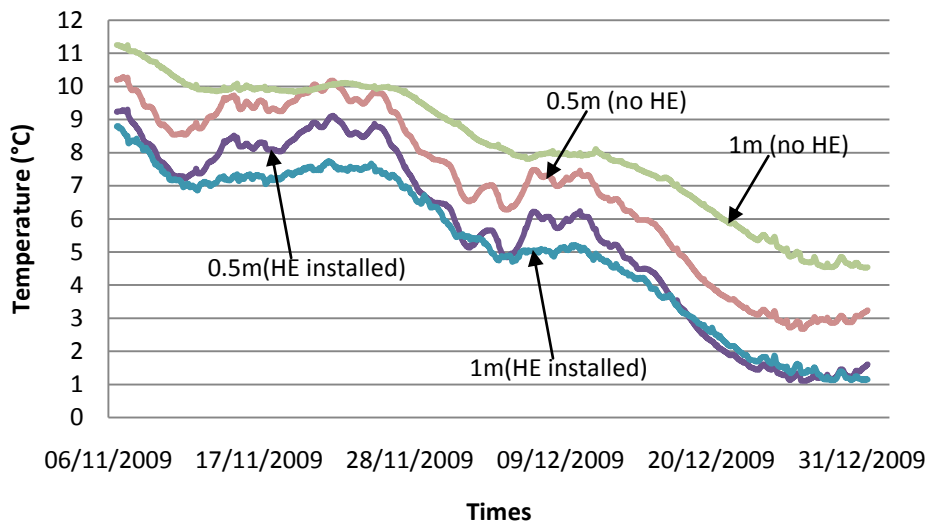

(c) At a depth of 0.5 and 1m below the ground surface

Figure 3 Measured ambient air and soil temperatures from 6th Nov 2009 to 31st Dec 2009

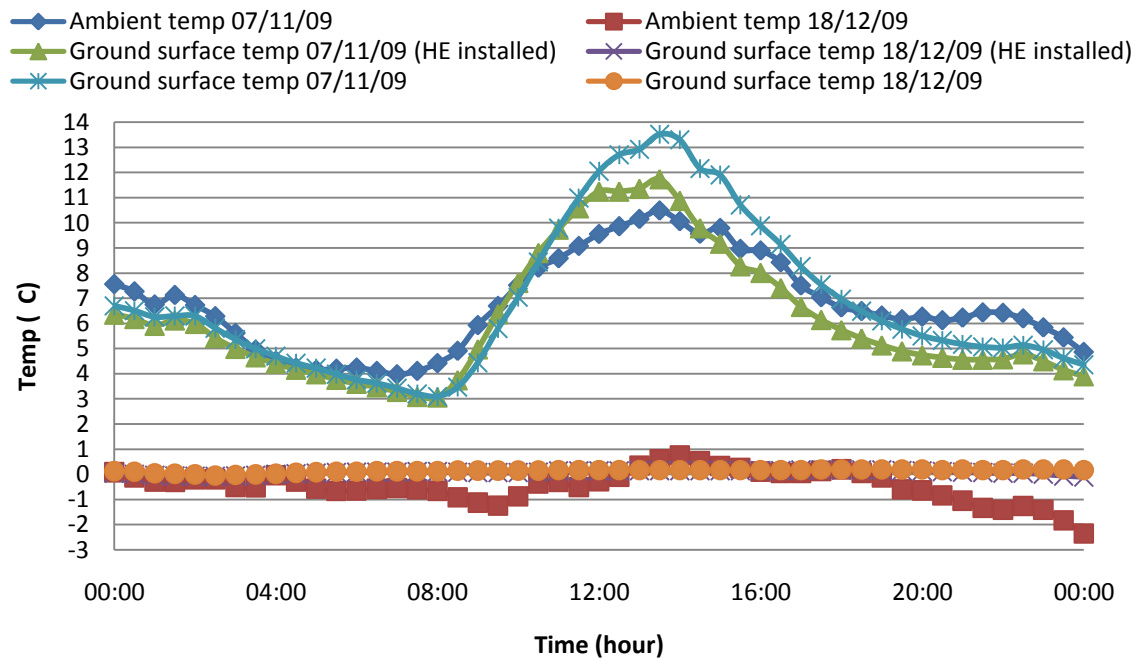
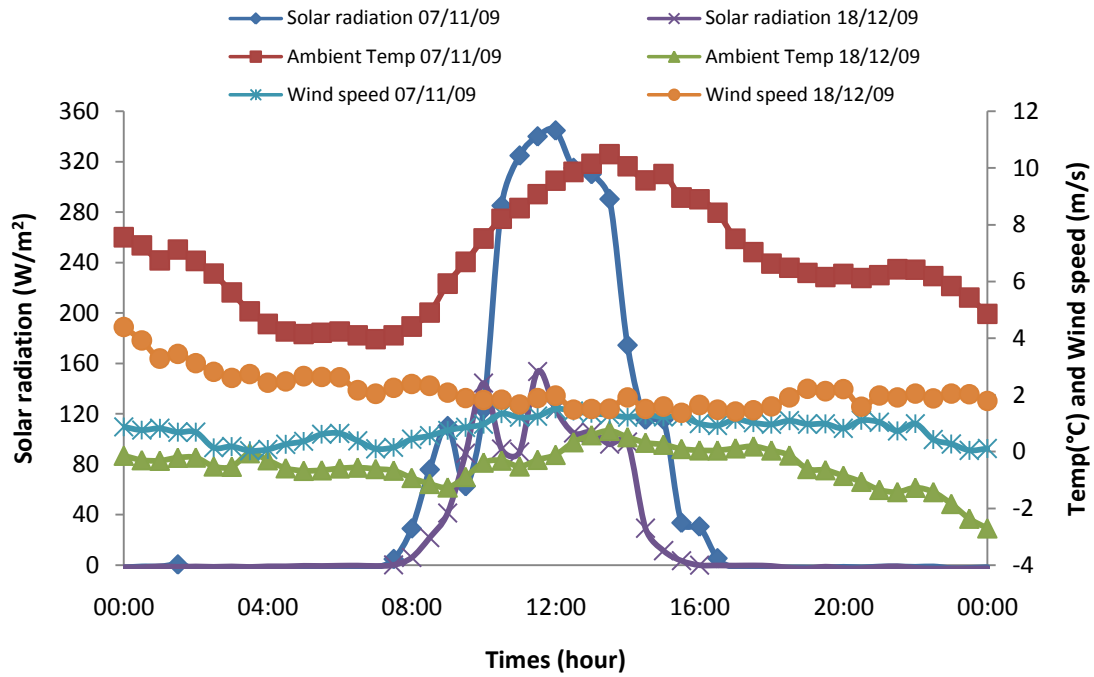
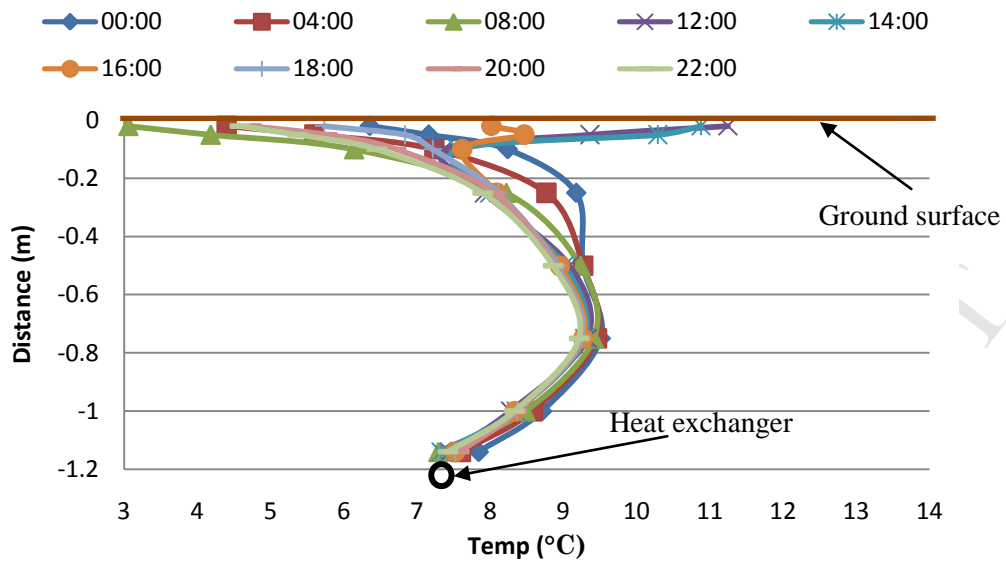
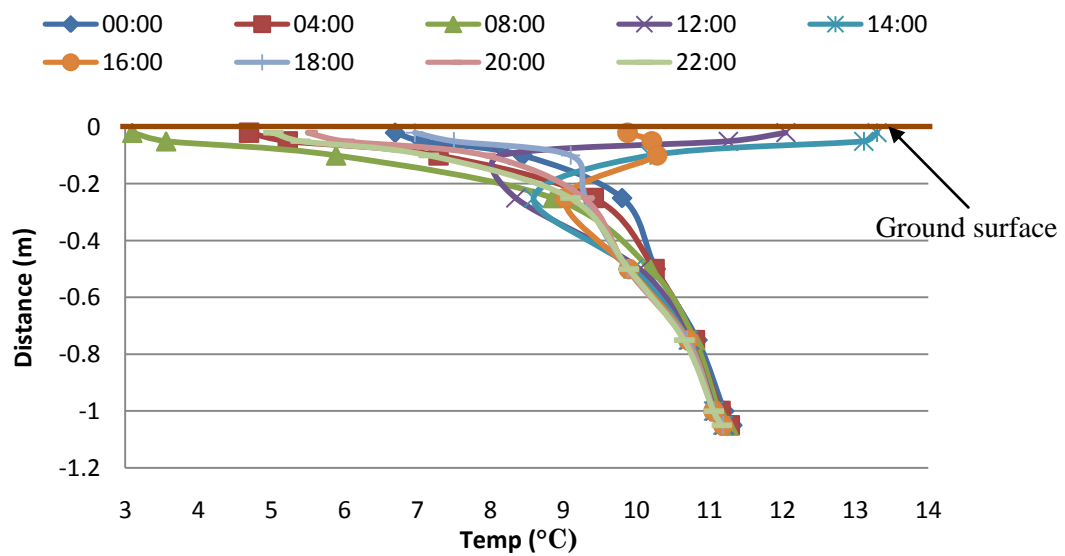

Figure 4 Measured ambient air temperature, ground surface temperature, solar radiation and wind speed on 7th Nov. and 28th Dec 2009



(a) Above the heat exchanger



(b) In the reference hole

Figure 5 Measured soil temperature variation on 7th Nov. 2009

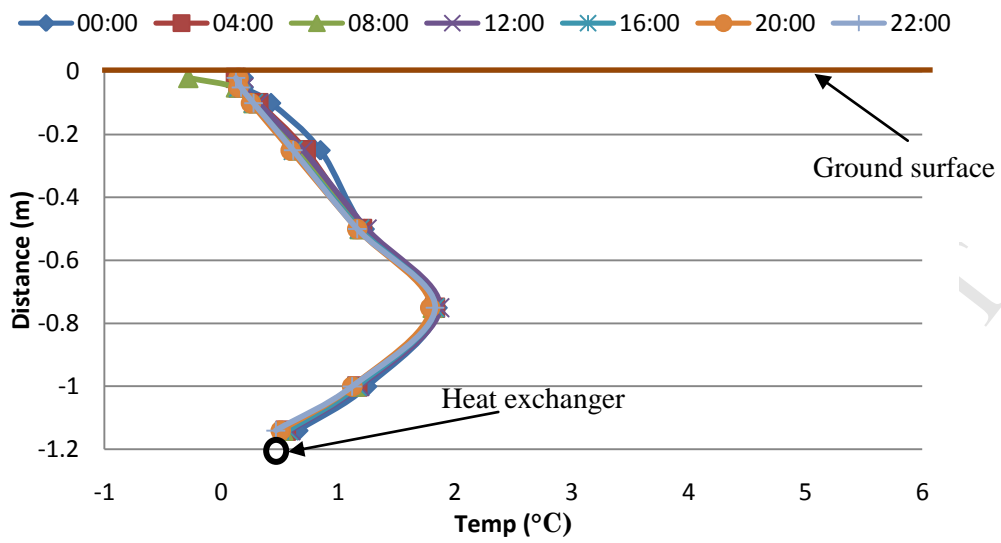

(a) Above the heat exchanger

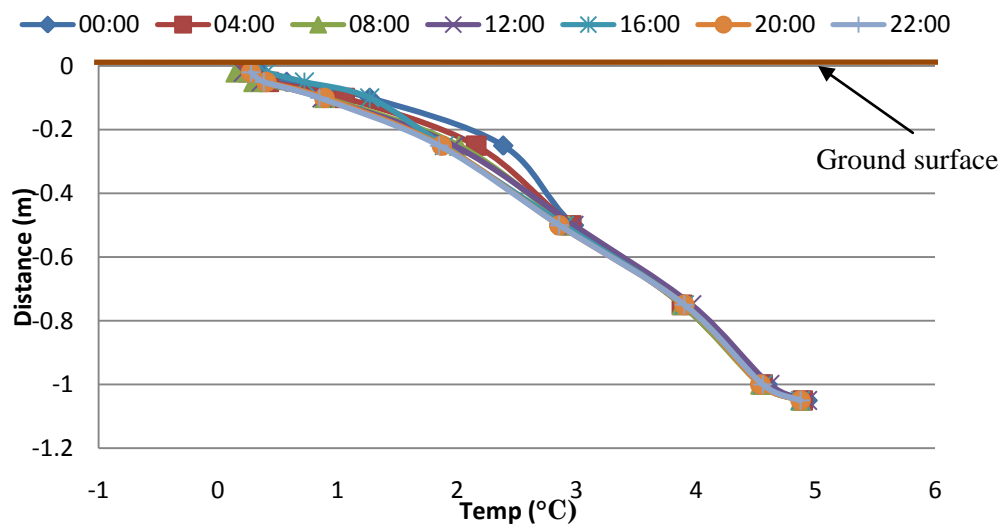

(b) In the reference hole

Figure 6 Measured soil temperature variation on 28th Dec. 2009

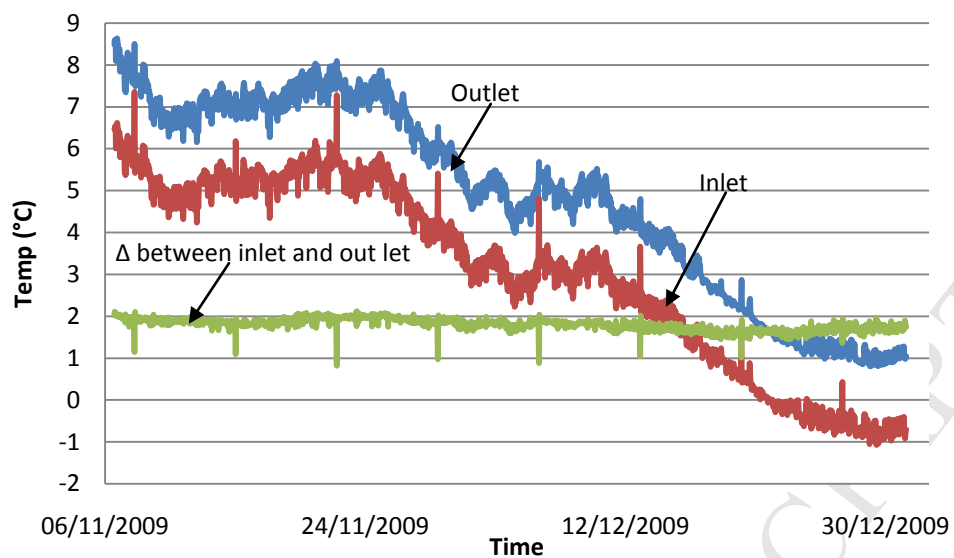

Figure 7 Measured variation of inlet and outlet temperatures of heat exchanger

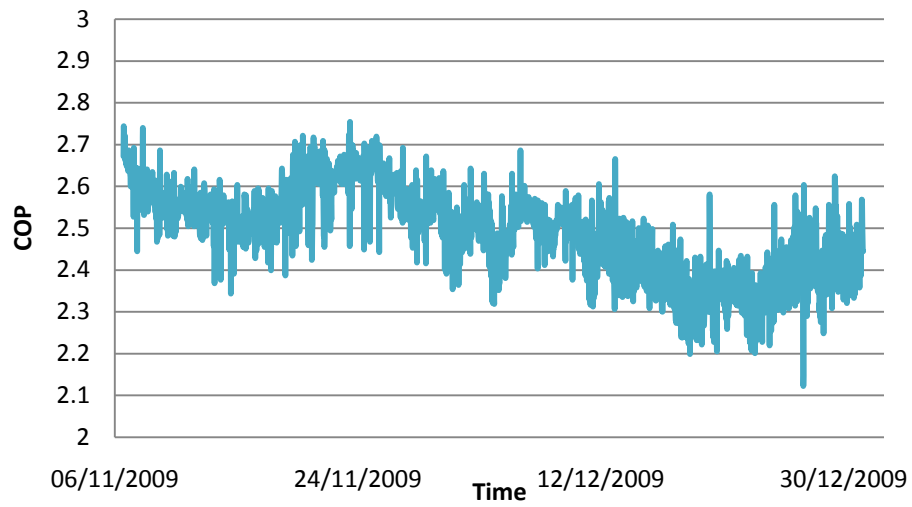

Figure 8 Measured variation of COP of the GSHP system

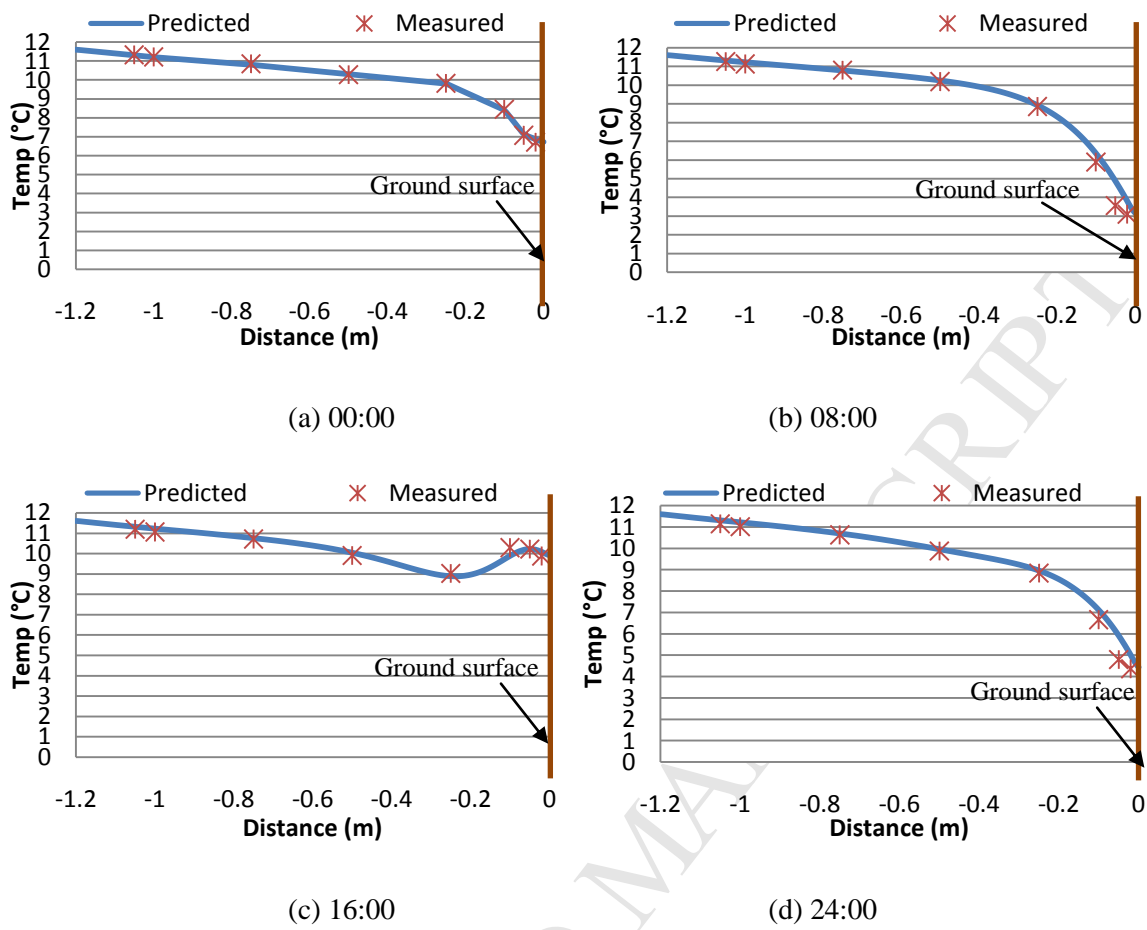

Figure 9 Predicted and measured soil temperatures at selected times on 07th Nov. 2009

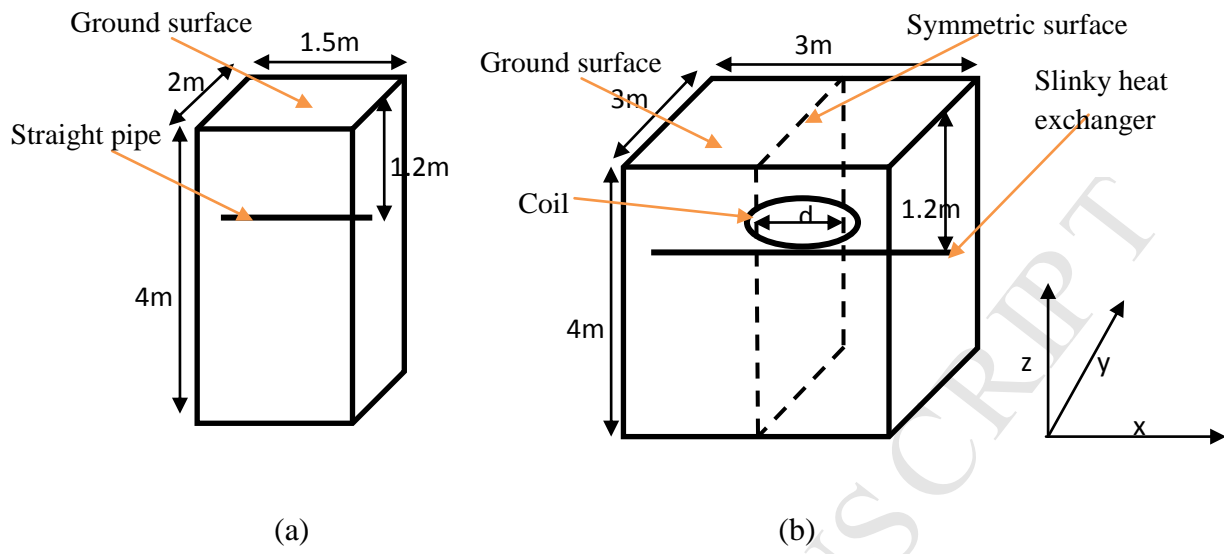

Figure 10 Sketch of a portion of horizontal coupled pipe (a) Straight pipe, (b) Slinky pipe

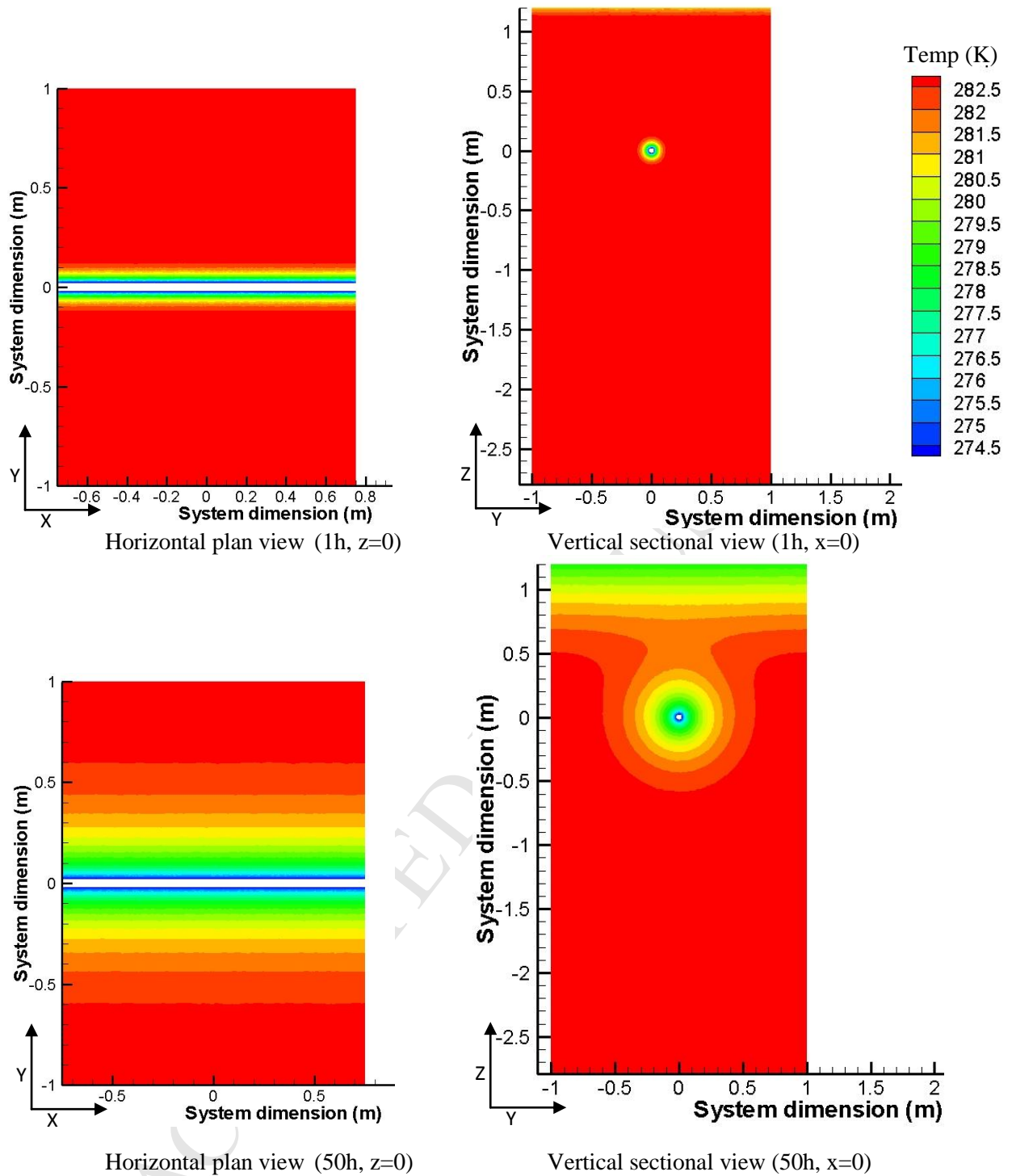
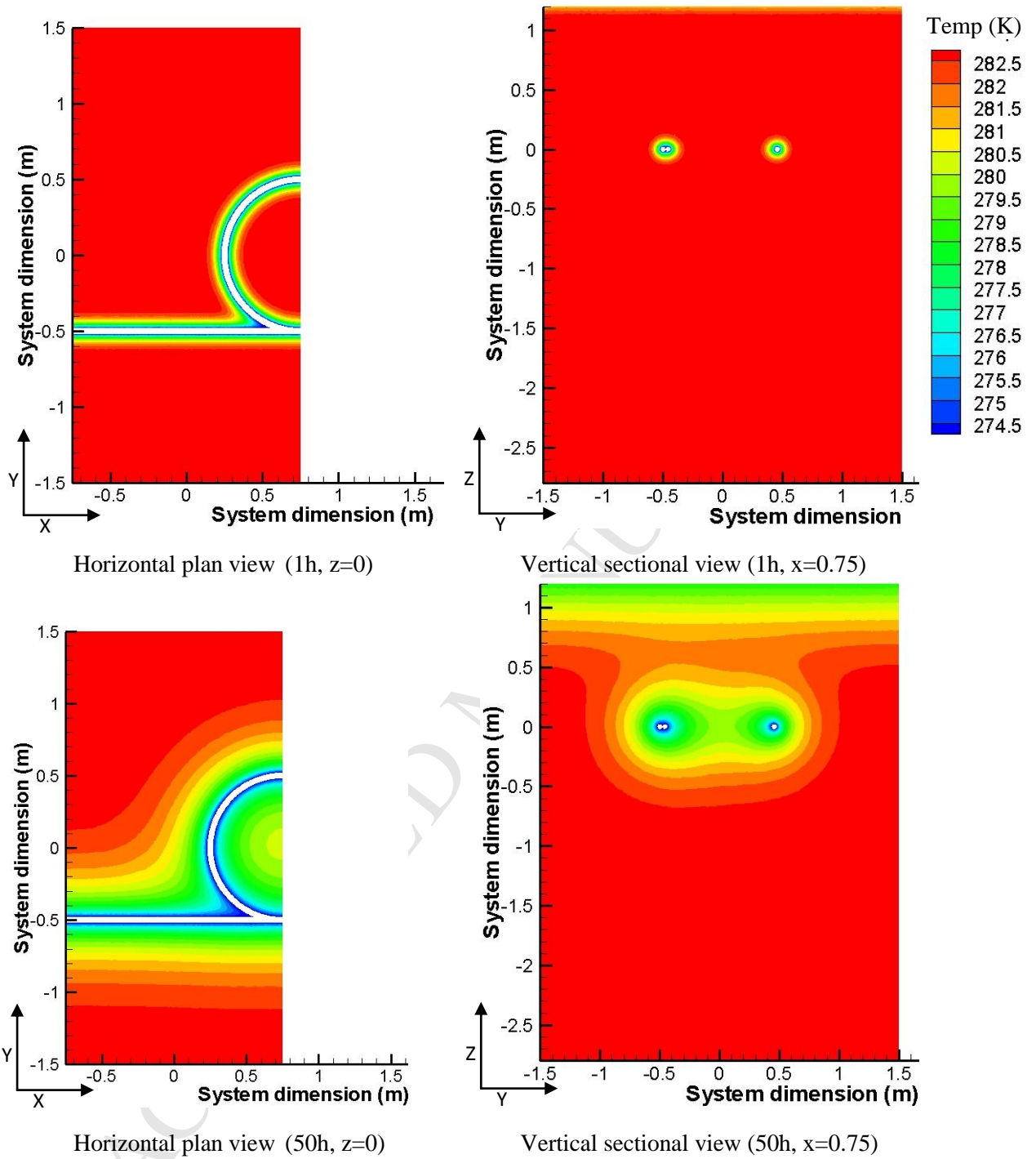

Figure 11 Isotherm generated from prediction for the straight heat exchanger at 1 and 50 hours



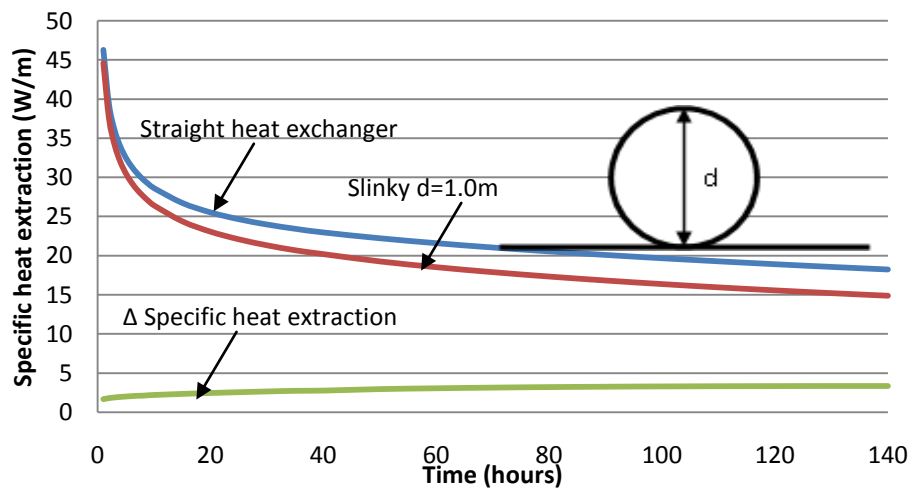

Figure 13 Predicted variation of specific heat extraction with time for the horizontal coupled straight and slinky heat exchangers

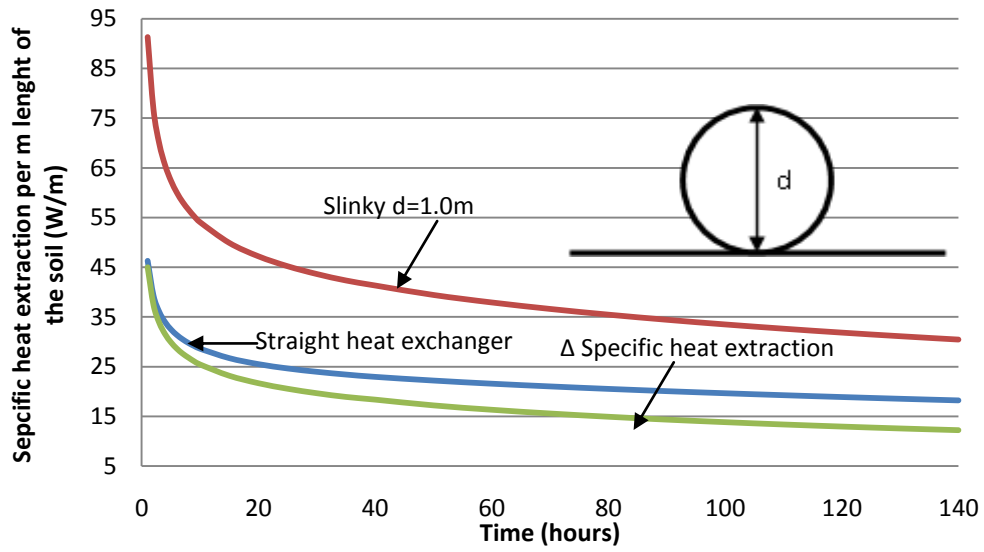

Figure 14 Predicted variation of the heat extraction per meter length of soil by straight and slinky heat exchanger with time

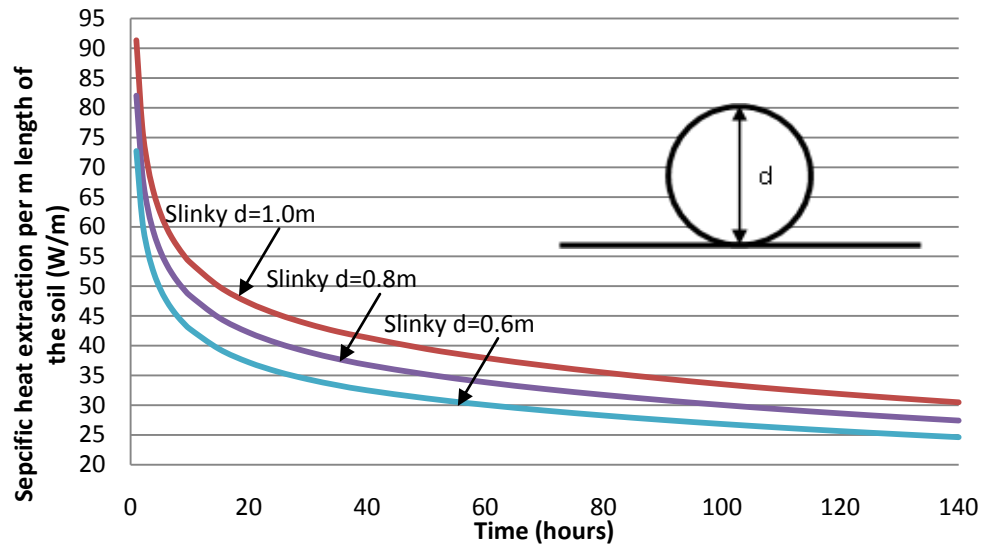

Figure 15 Predicted variation of the heat extraction per meter length of soil for slinky heat exchanger at different coil diameter

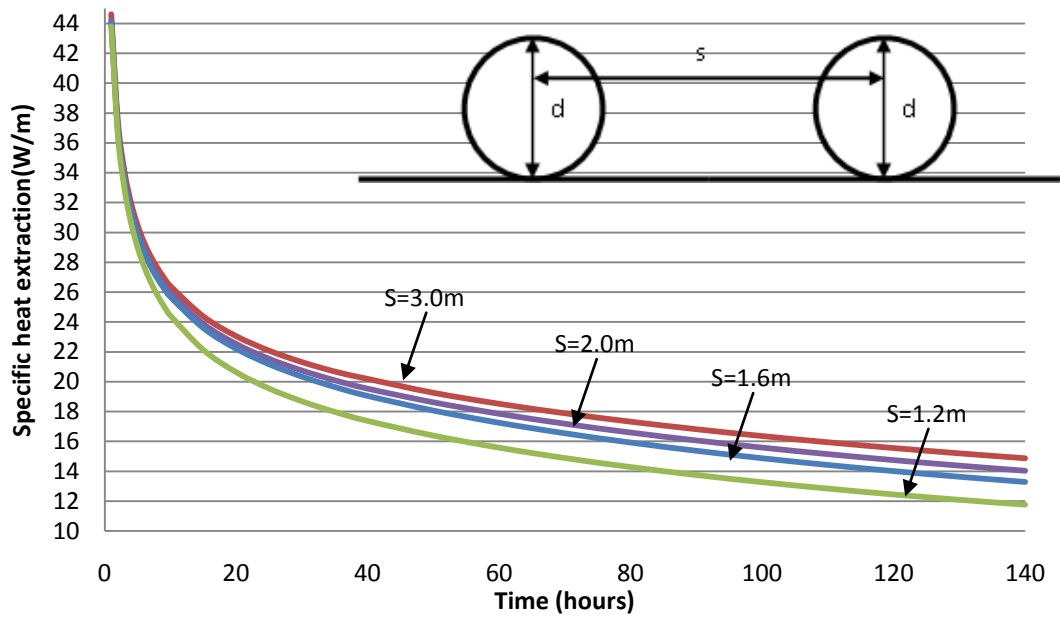

Figure 16 Predicted variation of specific heat extraction with time for slinky heat exchangers at different coil interval distances

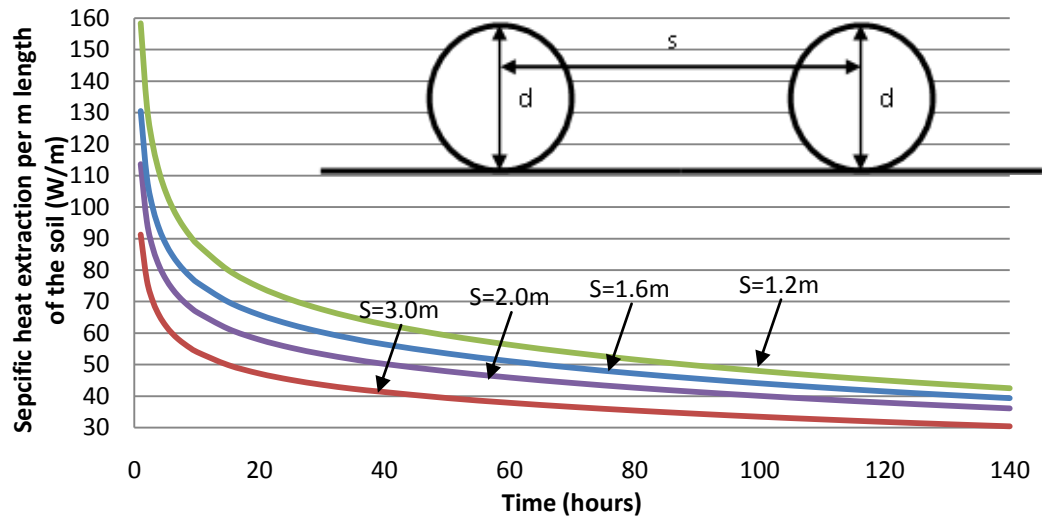

Figure 17 Predicted variation of the heat extraction per meter length of soil for slinky heat exchanger at different coil interval distances