



HAL
open science

A New Indirect Rotor Position Sensing with Resonant Method for Switched Reluctance Motor

Philippe Laurent, Mohamed Gabsi, Bernard Multon, Non Renseigné

► **To cite this version:**

Philippe Laurent, Mohamed Gabsi, Bernard Multon, Non Renseigné. A New Indirect Rotor Position Sensing with Resonant Method for Switched Reluctance Motor. PCIM Conference 1993, Jun 1993, NÜRNBERG, Germany. pp.324-331. hal-00674003

HAL Id: hal-00674003

<https://hal.science/hal-00674003>

Submitted on 24 Feb 2012

HAL is a multi-disciplinary open access archive for the deposit and dissemination of scientific research documents, whether they are published or not. The documents may come from teaching and research institutions in France or abroad, or from public or private research centers.

L'archive ouverte pluridisciplinaire **HAL**, est destinée au dépôt et à la diffusion de documents scientifiques de niveau recherche, publiés ou non, émanant des établissements d'enseignement et de recherche français ou étrangers, des laboratoires publics ou privés.

A NEW INDIRECT ROTOR POSITION SENSING WITH RESONANT METHOD FOR SWITCHED RELUCTANCE MOTOR

P. LAURENT, M. GABSI, B. MULTON

L.E.S.I.R URA CNRS D1375

ENS Cachan 61, Avenue du Pdt Wilson 94235 CACHAN CEDEX FRANCE

ABSTRACT

Discrete position sensors are undesirable in our automotive application. We are looking for a sensitive, simple, robust and low cost technique of indirect rotor position sensing method for a doubly salient motor.

This paper describes an original method based on the principle of inductance measurement in the unenergized phase.

A series resonant circuit $R L(\theta) C$ is used. $L(\theta)$ is the phase inductance varying with the rotor position. The capacitor value is determined by $L_o \cdot C \cdot \omega_{carrier} = 1$ (L_o is the minimum phase inductance).

The resonant circuit is supplied by a high frequency sinusoidal current generator. A synchronous demodulation technique, based on extracting of the maximal amplitude, gives us a voltage signal. This component is a direct measure of the angle linked to the phase inductance.

The advantages of this method are the simplicity, the low cost and the robustness. But the major one is the fact that it amplifies the phenomenon of inductance variation thereby enhancing the accuracy in the measurement of the position angles.

1-INTRODUCTION

The SRM torque is developed by controlling the magneto motive force in accordance with the reluctance variation. The energizing of phase windings must be synchronized with the rotor position. So it requires an angular position sensor.

Physical position sensors are undesirable in our automotive application because of hard environment, assembly problem and cost requirement. We are looking for sensitive, simple, robust and low cost technique of indirect rotor position sensing for a doubly salient motor.

Several authors have described indirect methods of detecting rotor position. These methods and their main disadvantage are :

- Detection of rotor position by monitoring of current waveforms [1] : Difficulties are due to the influence of motor speed, ohmic and electromagnetic losses, switching noise and converter voltage ripples.

- Generating of negative torque by injecting a diagnostic pulse in the unenergized phase [8] and limited resolution with speed increasing.
- Sophisticated method based on a state observer. A fast powerful processor is needed to do real time computation [6]
- Methods based on measuring of the mutually induced voltages [4]. This method requires significantly interphase coupling variation versus the rotor position. The second disadvantage is the magnetic saturation influence.
- Methods based on modulation techniques: the phase, amplitude, or frequency modulations [2],[3]. Usually, a sinusoidal current is applied to the phase coil and we note the phase and amplitude variations of the corresponding voltage due to the varying inductance. In this paper we will show how to increase the accuracy of these methods by a resonant application. This method is based on the comparison of the demodulated voltage amplitude

with a reference voltage corresponding to the unaligned position. Most authors identify the electrical parameters of the stator winding with a R-L serial model. The problem lies in the fact that these parameters are very dependant of amplitude and frequency test signal. They seem to be very different from the phase parameters measured in power feeding conditions.

2-PARAMETER IDENTIFICATION METHOD

In this part, we will show the influence of the amplitude and frequency test signal upon the inductive and resistive parameter variation. A first identification is provided by means of alternating current source at 50 Hz, 3A rms. and a second one with our high frequency carrier (30kHz 20 mA rms). The result of this identification is indicated on figure 1. The two model parameter are computing thanks to a KAPP triangle method.

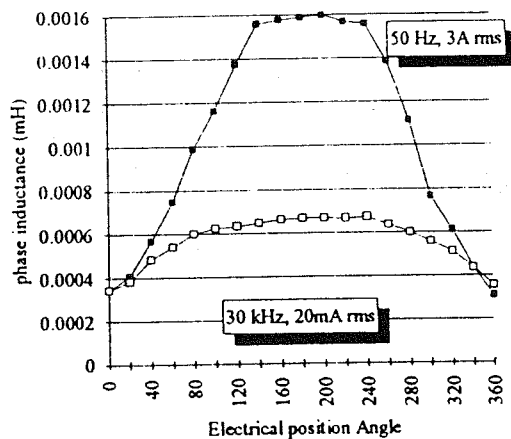

figure 1 : influence of frequency and amplitude level upon the serial inductive parameter.

We see on this figure that the variation of the inductive parameter decreases in high frequency and low level current measurement conditions. The reason of inductance decreasing at high frequency and low level current is probably the diminution of magnetic material permeability. So this problem is less important at aligned position. The resistive parameter of our R-L model is also dependant of these measurement conditions. This is shown in figure 2.

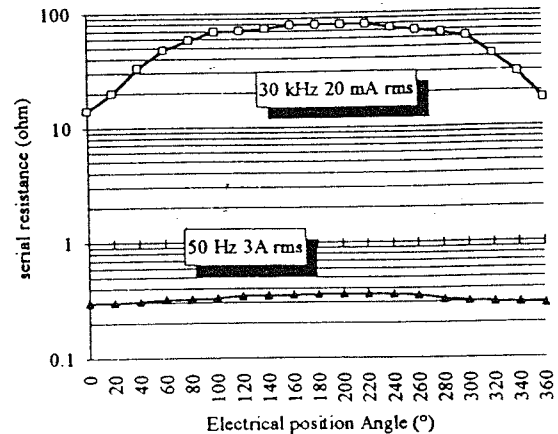

figure 2 : influence of amplitude level and frequency upon the serial resistive parameter.

Here we can see that the resistive parameter will increases with the frequency identification signal. This corresponding variation is shown in figure 3 for the two main positions of rotor: the unaligned position (rotor angle=0°) the aligned position (rotor angle=180°)

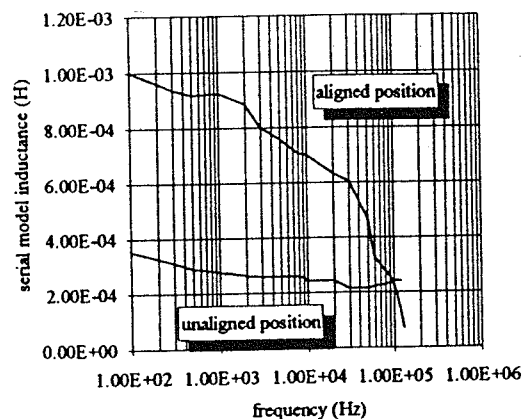

figure 3 : influence of frequency upon the serial inductive parameter :condition 20mA rms.

We can conclude that the choice of the carrier frequency will influence the magnitude of the demodulated voltage. The variation of the inductive parameter between aligned and unaligned positions decreases in high frequency. Besides, the frequency value of the carrier determines the position measurement resolution. So a sufficient frequency value is required in accordance to maximum speed..

If Ω describe the mechanical rotor speed (rpm) and N_r number of the rotor poles ($N_r=4$ in our application) the electrical frequency is F_e :

$$F_e = \frac{\Omega \cdot N_r}{60} \quad (\text{ex: } 200\text{Hz at } 3000 \text{ rpm})$$

$$\omega_e = 2 \cdot \pi \cdot F_e \text{ electrical pulsation}$$

In case of a q phase machine, the duration of each scanning window is T_{scan} (s):

$$T_{\text{scan}} = \frac{1}{q \cdot F_e} \quad (\text{ex: } 1.66 \text{ ms for } 3 \text{ phases and } 3000 \text{ rpm})$$

Then, each period of the high frequency injected carrier provides one point of position measurement so the global resolution N_p (number of point per supply window) is:

$$N_p = F_{\text{carrier}} \cdot T_{\text{scan}} = \frac{F_{\text{carrier}} \cdot 60}{q \cdot \Omega \cdot N_r}$$

So the resolution of the measure will linearly increase with the carrier frequency. There is a contradiction between the position resolution and the maximum demodulated voltage variation regardless aligned and unaligned rotor position. In figure 4, we show the relative variation of the inductive parameter between the two main positions of rotor versus frequency modulation.

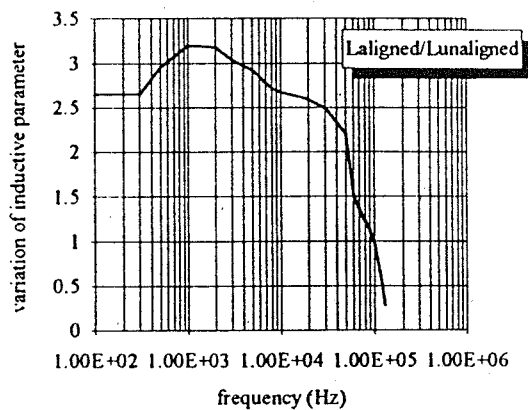

figure 4: relative variation of the inductive parameter between aligned and unaligned position versus carrier frequency (condition: 20 mA rms.)

Then we have to choose a compromise between carrier sensitivity and the dynamic position resolution (especially in high speed). We have chosen a 30 kHz carrier signal. The corresponding inductive parameter variation is about 2,3 (figure

4) and the minimum resolution is 50 points per scanning window at the highest speed (3000 rpm). This gives us a numerical position resolution of 2.4 electrical degrees per point at this highest speed.

The main disadvantage of this method is the low variation of the measuring signal with the rotor position. In order to increase this variation ($L_{\text{aligned}}/L_{\text{unaligned}}=2,3$ at 30 kHz) we propose to virtually increase this variation by the local adjunction of a negative reactive term in the unaligned position. This can be realised by using a RLC resonant circuit. This gives us a measure signal which varies significantly with the rotor position and thereby enhances the accuracy resolution in the measurement of the position angles.

3-INDIRECT RESONANT ROTOR POSITION SENSING PRINCIPLE

A series resonant circuit $RL(\theta)C$ is used [5].

$L(\theta)$ is the phase inductance value varying with the rotor position.

The resonant capacitor value is determined to obtain: $L_o \cdot C \cdot \omega_{\text{carrier}}^2 = 1$

L_o : the minimum inductance (unaligned position); $\omega_{\text{carrier}} = 2 \cdot \pi \cdot F_{\text{carrier}}$

By measuring the voltage U_{lc} (figure 5), we can detect particular position (the unaligned one for our application). The influence of speed effects is reduced because of the serial model resistor containing magnetic losses (iron and copper). The magnetic loss effect is higher than the ohmic coil and the speed equivalent ones.

The magnetizing equation is described as follow:

$$U_{lc} = (R_{dc} + R_{\text{magnet}}) \cdot i + i \cdot \omega_e \cdot \frac{dL}{d\theta} + L(\theta) \cdot \frac{di}{dt} + \frac{1}{C} \int i \cdot dt$$

i designate the carrier current, R_{dc} the coil resistor and θ the electrical angle;

$$\text{we put: } R_{\text{eq}} = R_{dc} + R_{\text{magnet}} + \omega_e \cdot \frac{dL}{d\theta}$$

R_{magnet} represent the sum of electromagnetic losses.

In this equation, the speed influence term is designed by :

$$\omega_e \cdot \frac{dL}{d\theta}$$

ω_c design the electrical pulsation. If we adopt a trapezoidal model for the parameter inductance :

$$\frac{dL}{d\theta} \approx \frac{\Delta L}{\Delta\theta} = \frac{L_{\text{aligned}} - L_{\text{unaligned}}}{\frac{2 \cdot \pi}{3}}$$

The $\omega_c \cdot \frac{dL}{d\theta}$ term can be compared with a serial resistor parameter. In the worst case of the application ($\Omega=3000$ rpm) this parameter value is 0.2 Ohm. So we can reasonably missed it in regard to the minimum model resistor value (14 Ohm: figure 2).

The resonant circuit is supplied with high frequency sinusoidal current generator.

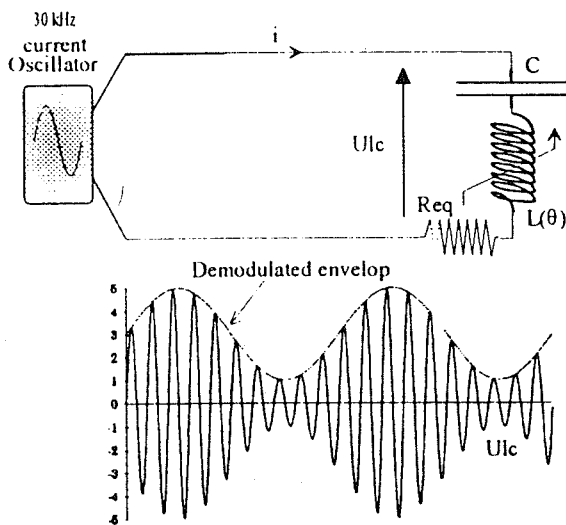

Figure 5: Basic scheme of the measure method

Udemodulated is obtained by a synchronous demodulation technique based on extracting of the U1c maximal amplitude. This component is a direct measure of the angle linked to phase inductance. The minimum of Udemodulated corresponds to the unaligned position ($L_o \cdot C \cdot \omega_{\text{carrier}}^2 = 1$).

With this R-L classic method:

The impedance of serial circuit is determined by:

$$Z(s) = \text{Req}(\theta) + L(\theta) \cdot s$$

where s is the laplace operator.

At aligned position:

$$|Z| = Z_{\text{max}} = \sqrt{R_{\text{max}}^2 + (L_{\text{max}} \cdot \omega_{\text{carrier}})^2}$$

At unaligned position:

$$|Z| = Z_o = \sqrt{R_o^2 + (L_o \cdot \omega_{\text{carrier}})^2}$$

So the maximum relative variation of the impedance is :

$$\frac{Z_{\text{max}}}{Z_o} = \sqrt{\frac{R_{\text{max}}^2 + (L_{\text{max}} \cdot \omega_{\text{carrier}})^2}{R_o^2 + (L_o \cdot \omega_{\text{carrier}})^2}} \approx 2.2 \text{ (cf figure 6)}$$

With R-L-C method:

The impedance of resonant circuit is determined by:

$$Z(s) = \frac{1}{C_s} + L(\theta) \cdot s + \text{Req}(\theta) = \frac{1 + L(\theta) \cdot C \cdot s^2}{C_s} + \text{Req}(\theta)$$

At resonant frequency \Leftrightarrow unaligned position:

$$(L(\theta)=L_o \text{ and } L_o \cdot C \cdot \omega_{\text{carrier}}^2 = 1): Z_o=R_o$$

At aligned position

$$(L(\theta)=L_{\text{max}}=L_o+\Delta L)$$

$$Z_{\text{max}} = \sqrt{R_{\text{max}}^2 + (\Delta L \cdot \omega_{\text{carrier}})^2}$$

So the relative variation of the impedance is:

$$\frac{Z_{\text{max}}}{Z_o} \approx \sqrt{\frac{R_{\text{max}}^2 + (\Delta L \cdot \omega_{\text{carrier}})^2}{R_o^2}} \approx 7.2 \text{ (cf figure 6)}$$

This RL(theta)C method amplifies the inductance variations and improves the measurement resolution. In figure 6, we present the $\frac{|Z|}{Z_o}$ theoretical variation in case of resonant method and (R,L) classic method [2] without resonance.

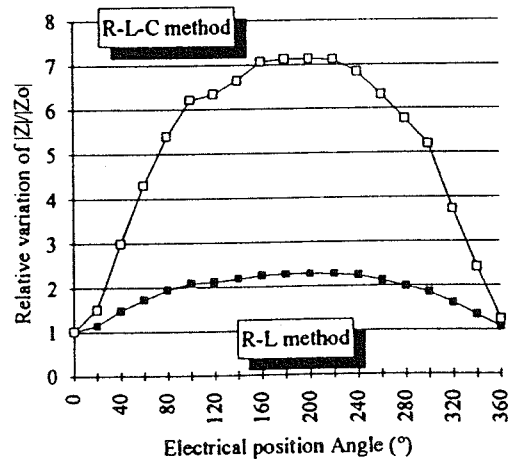

Figure 6: Theoretical $|Z|/Z_o$ variation for a R-L and R-L-C method.

4- EXPERIMENTAL RESULTS

We can also compare the two corresponding modulated carrier voltage for each method. This is shown in figure 7 for the R-L method and figure 8 for the RLC one.

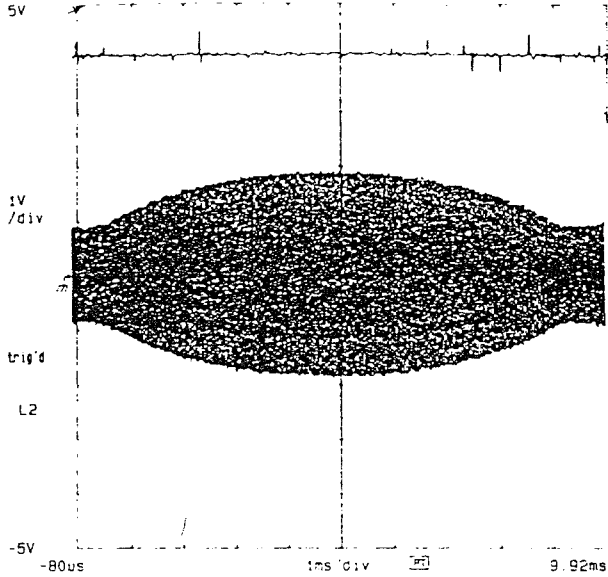

figure 7: example of modulated carrier voltage for a R-L method (carrier=20kHz, 20 nA rms.)

The maximum relative variation is about 2. This is not sensitive enough for a correct determination of the rotor position (especially at the unaligned position).

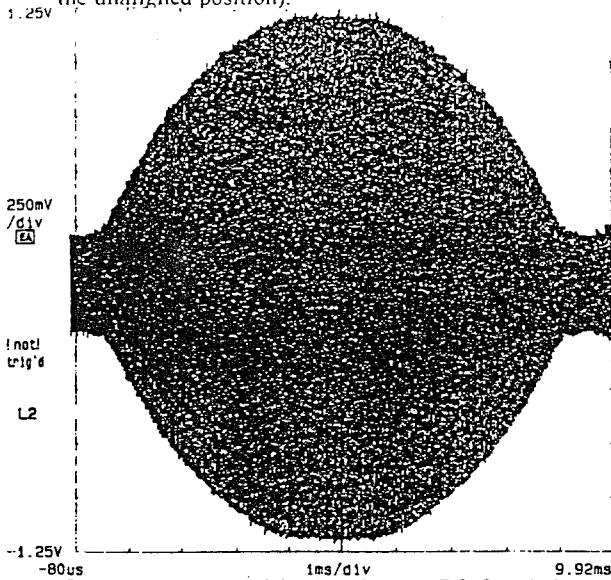

figure 8: example of modulated carrier for a R-L-C method (same carrier conditions)

The maximum relative variation is about 6.5. It becomes sensitive enough especially at the unaligned position. So the accuracy is locally increased at the unaligned position thanks to the resonant circuit.

Figure 9 presents experimental results: Udemo corresponds to the phase number 2 and the drive signal window corresponding to the phase 1.

DSA 601A DIGITIZING SIGNAL ANALYZER
date: 24-APR-92 time: 14:14:25

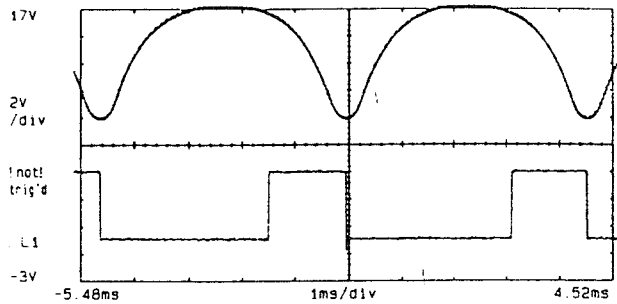

Figure 9 Shape of real demodulated voltage corresponding to the phase number 2 and the drive switching signal of the phase number 1.

This application was tested with a 3 phases SRM (0.1N.m, 3000 rpm) with bifilar windings.

Without feeding of the SRM (rotation is provided by a DC motor), the indirect position signal is reliable as shown in figure 9.

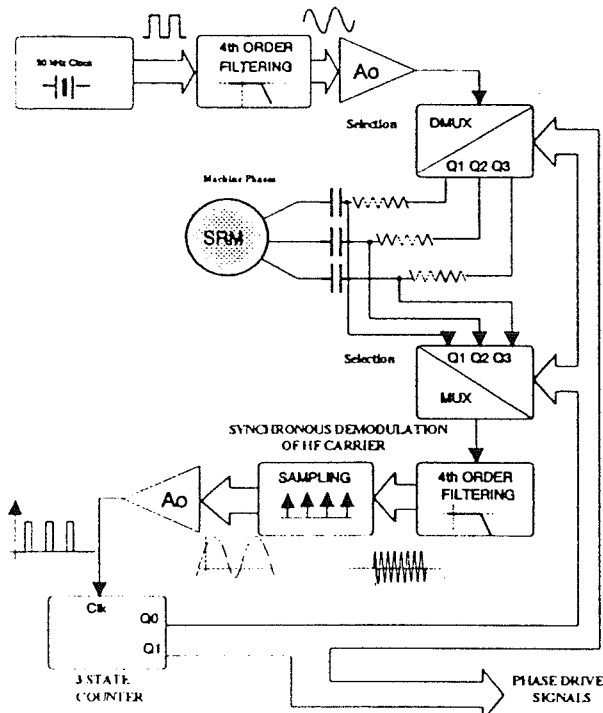

Figure 10: Block diagram of position control

5-ELECTRICAL PERTURBATIONS

When the phases are supplied in pulse width modulation mode or with self switching control [12], converter switching noise appears in the demodulated voltage and the signal becomes polluted. So we have used a method that consists in locking the sampling circuit (synchronous demodulation section figure 10) at each switching instant.

The demodulated signal is also locked during the switch commutation and then there is no more errors transmitted to the position comparator (Ao in figure 10).

Figure 11 and 12 show demodulated signal before and after locking of the sampling with a self switching power converter.

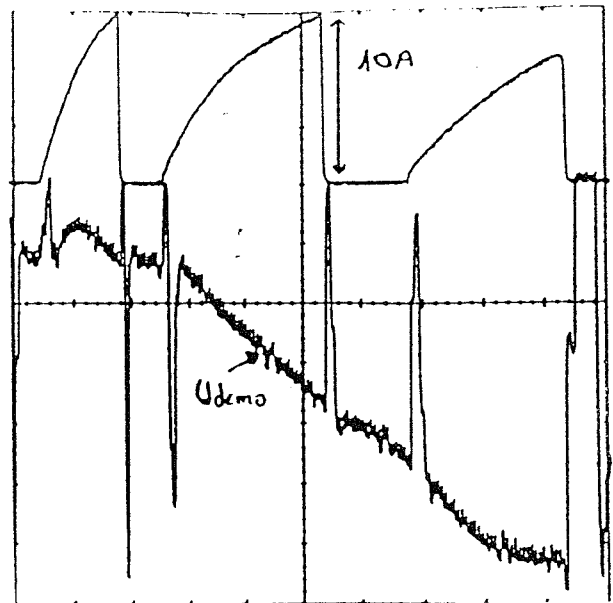

figure 11: demodulated signal before locking of the sampling circuit and shape of the current in the magnetizing coil.

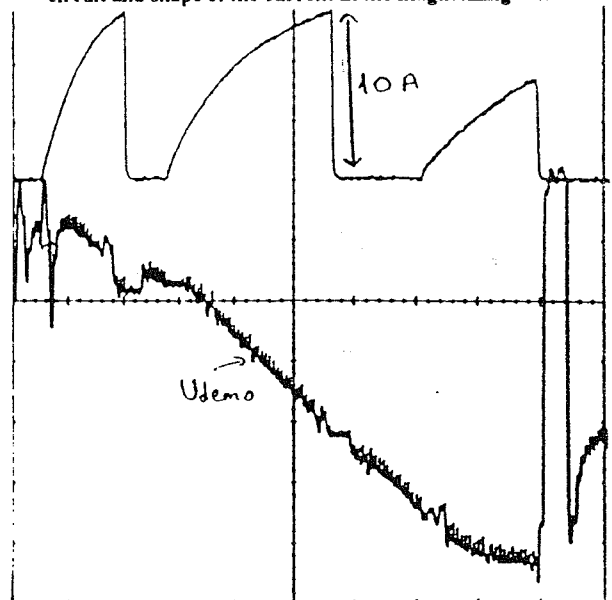

Figure 12: demodulated signal after locking of the sampling circuit and shape of the current in the magnetizing coil

We can see that this locking method allow a good insensitivity to the switching noise.

6-CONCLUSION

The main disadvantage of a carrier injection and demodulation method is the low variation of the measuring signal with the rotor position.

This phenomenon is more important with high frequency and low level excitation carrier signal.[10]. In this paper, we suggested a new method to improve accuracy. This method is based on resonance of phase motor with a serial capacitor. If high speed is required, carrier frequency has to be increased, however, coil impedance becomes capacitive. So it is not ever possible to exploit inductive variation of our model. We can envisage to use equivalent resistor variation (R_{magnet} mainly) versus the position measurement (figure 2).

REFERENCES

[1] P.P. ACARNLEY, R.J. HILL, C.W. HOOPER

"Detection of Rotor Position in Stepping and Switched Motors by Monitoring of Current Waveforms", IEEE IE-32, N°3, august 1985, pp.215-222.

[2] M. EHSANI, I. HUSAIN, A.B. KULKARNI

"Elimination of Discrete Position Sensor and Current Sensor in Switched Reluctance Motor Drives" IEEE Trans.I.A., Vol.28, N°1, Jan./Feb.1992, pp.128-135.

[3] M. EHSANI, S. MAHAJAN, K.R. RAMANI, HUSAIN

"New modulation encoding techniques for indirect rotor position sensing in switched reluctance motors" IEEE IAS Conf., october 1992, Vol.1, pp.430-438.

[4] M. EHSANI, I. HUSAIN

"Rotor position sensing in switched reluctance motor drives by measuring mutually induced voltage" IEEE IAS Conf., Houston, october 1992, pp.422-429.

[5] P. LAURENT, B. MULTON, M. GABSI,

"Procédé pour autopiloter sans capteur direct de position un moteur à réluctance variable et dispositif pour sa mise en oeuvre"
Brevet Français n° 92 13235, 4 novembre 1992. Sté déposant VALEO.

[6] A. LUMSDAINE, J. H. LANG

"State observers for variable - reluctance motors"
IEEE Trans. IE, Vol.37, N°2, april 90, pp.133-142.

[7] B. MULTON, M. GABSI

"Influence de l'entrefer sur les performances et le dimensionnement d'un moteur à réluctance variable à double saillance et de son onduleur"
7ème colloque internat. sur les moteurs pas à pas, Nancy 1-3 juillet 1992, pp.134-150.

[8] N.H. MVUNGI, J.M. STEPHENSON

"Accurate Sensorless Rotor Position Detection in an S.R. Motor".
E.P.E. FIRENZE 1991, pp.1/390-393.

[9] S.K. PANDA, G.A.J. AMARATUNGA

"Comparison of two Techniques for Closed-Loop Drive of V.R. Step Motors without Direct Rotor Position Sensing". IEEE Trans. on I.E., Vol.38, N°2, april 1991, pp.95-101.

[10] B. MULTON, M. GEOFFROY, P.F. DESESQUELLES

"Variable reluctance rotating shaft sensor for DC brushless vernier reluctance motor"
1st congress Japanese-French of MECHATRONICS, Besançon, oct. 1992, 6 p.

[11] W.D. HARRIS, J.H. LANG

"A simple motion estimator for variable reluctance motors"
IEEE trans.I.A, Vol.28, N°2, Mar./Apr. 1990 pp.237-243.

[12] P. LAURENT, B. MULTON, M. GABSI

"Comparison of electromagnetic perturbations between self-switching and PWM mode for current control of a switched reluctance motor"
PCIM-93 conferences.