



HAL
open science

Current Feeding of Switched Reluctance Motor. Optimization of the Current Waveform to Minimize the Torque Ripple

Jean-Yves Le Chenadec, Bernard Multon, Sami Hassine

► **To cite this version:**

Jean-Yves Le Chenadec, Bernard Multon, Sami Hassine. Current Feeding of Switched Reluctance Motor. Optimization of the Current Waveform to Minimize the Torque Ripple. IMACS TC1'93, Jul 1993, MONTREAL, Canada. pp.267-272. hal-00673932

HAL Id: hal-00673932

<https://hal.science/hal-00673932>

Submitted on 24 Feb 2012

HAL is a multi-disciplinary open access archive for the deposit and dissemination of scientific research documents, whether they are published or not. The documents may come from teaching and research institutions in France or abroad, or from public or private research centers.

L'archive ouverte pluridisciplinaire **HAL**, est destinée au dépôt et à la diffusion de documents scientifiques de niveau recherche, publiés ou non, émanant des établissements d'enseignement et de recherche français ou étrangers, des laboratoires publics ou privés.

CURRENT FEEDING OF SWITCHED RELUCTANCE MOTOR. OPTIMIZATION OF THE CURRENT WAVE FORM TO MINIMIZE THE TORQUE RIPPLE.

LE CHENADEC J.Y., MULTON B., HASSINE S.
LESiR (Laboratoire d'Electricité, Signaux et Robotique) URA CNRS D1375
Ecole Normale Supérieure de CACHAN
61 Av du Pt WILSON
94235 CACHAN CEDEX FRANCE

1. Abstract

The torque ripple remains one of the main problem linked to the use of switched reluctance motor. In order to use these drives in low speed application, we have imagined a current control, with optimized waveforms allowing torque ripple minimization. We have take account motor parameters and converter voltage limitations. We applied this control method to a 4kW drive.

2. Introduction

If we know the principle of switched reluctance motor since one hundred and fifty years, their development kept limited until the beginning of the 70's, despite the great advantages presented by that kind of machine. These advantages are:

- * low cost of industrial production,
- * simplicity of converter,
- * high torque at low speed,
- * Robustness

Unfortunately, this kind of motor introduces two main disadvantages:

- * An acoustic noise relatively important,
- * A pulsating instantaneous torque.

Whole works realised on square voltage supply has shown that if the ratio silicium power (VA converter) / mechanical power could be relatively interesting (or at last comparable to ratios obtained with others kind of motors[6]). It is very difficult to have simultaneously a good ratio silicium power/mechanical power and a low peak to peak ripple torque (less than 10%) with this kind of supply.

So, we decided to search for feeding mode in order to reduce the ripple torque, mostly in the case of doubly salient structure (Fig[1]). For that, our objective was to obtain trapezoidal single-phase torque waveform.

This waveform is characterised by the angles A1,A2,A3 described at Fig [2], the angle 0 is the reference and correspond to the unaligned position.

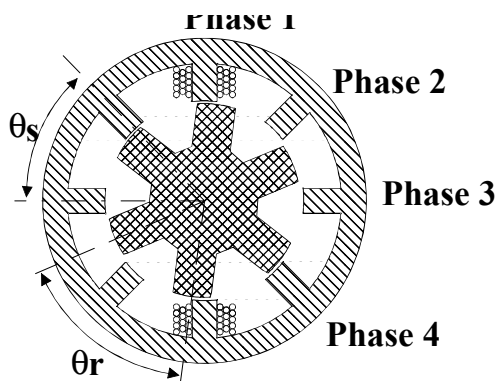

Fig[1]
Four phase doubly salient Structure.

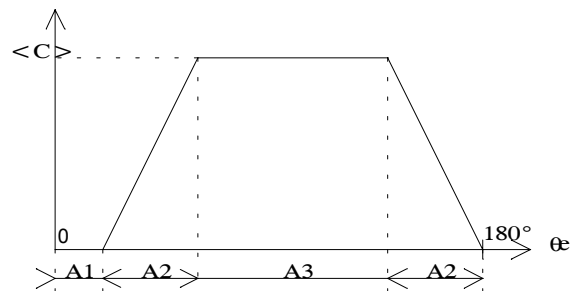

Fig [2]
Definition of the torque reference

To have a good juxtaposition of single-phase torque waveforms for all phases, we have to check:

$$A2+A3 = \frac{360^\circ}{q} \text{ and } A1+A2 < 180 - \frac{360^\circ}{q}$$

where q is the phase number.

Once these conditions reached, we are able to define the torque reference with only A1 and A2 values.

3. Modelling.

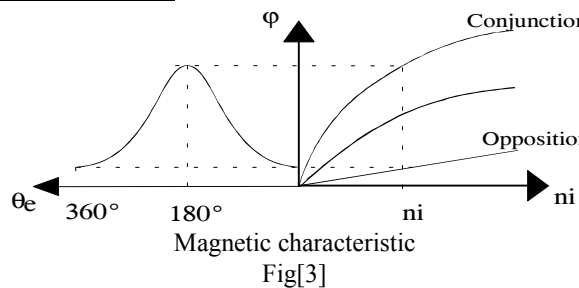

The radically non linear feature of this kind of structure (magnetic saturation, permeance waveform not sinusoidal), leads us to use an energetic modelling.

If we do not pay attention to copper losses, the energetic result of the system expressed itself in the relation: $dW_e = dW_{em} + dW_m$, where W_e is electric energy, W_{em} the electromagnetic one stored in the machine, W_m the mechanic one. So we can write the following equations:

$$c = -\frac{\partial W_{em}}{\partial \theta_m} \text{ et } \varphi = -\frac{\partial W_{em}}{\partial (ni)}$$

These equations allow, in the case of current supply, to calculate flux and torque, from knowing of energetic state of the machine.

Energetic model

The calculation of the magnetic energy is directly linked to the knowing of the electromagnetic characteristic of the machine [fig 4]. To reduce the number of errors due to a rough model, we have chosen to measure the particularly characteristic of our motor (OULTON 4kW@3000rpm). So we could deduce the

characteristic Torque/Position/Current [fig5]: We can also directly measure this characteristic array.

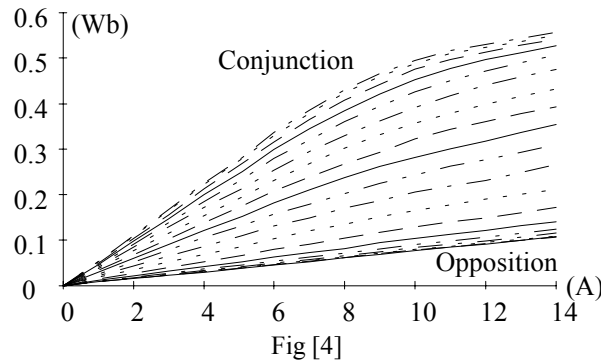

$\Phi(I, \theta_e)$ characteristic array for the OULTON motor

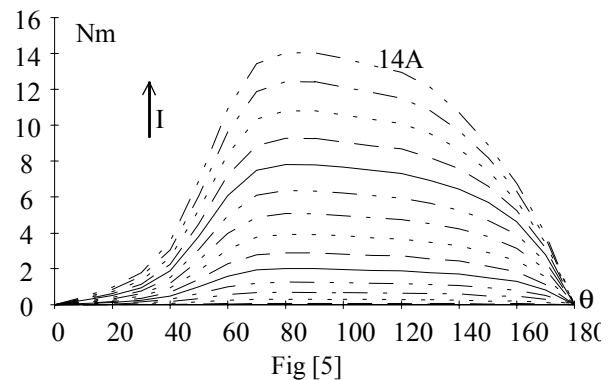

$T(I, \theta_e)$ characteristic array for the OULTON motor.

4. Optimization of current waveform for our motor.

Thanks the characteristics $\Phi(I, \theta_e)$ and $T(I, \theta_e)$, it is possible to calculate the current waveform to obtain a trapezoidal single-phase torque waveform (Fig[6]). Then we can calculate the flux variation in the motor, so the voltage waveform corresponding (Fig[7]). The maximum voltage could be particularly high, specially for high speed (high $\frac{d\phi}{dt}$). But in practice, the voltage value is limited by the supply source. It results a current distortion (Fig[6]) leading to a distortion of the single-phase torque and so a ripple of the instantaneous torque.

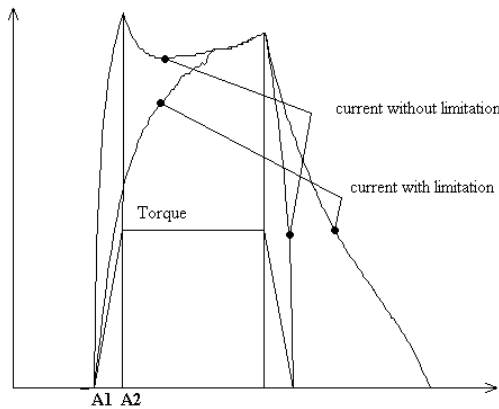

Fig[6]

Computed current waveforms with and without voltage limitation

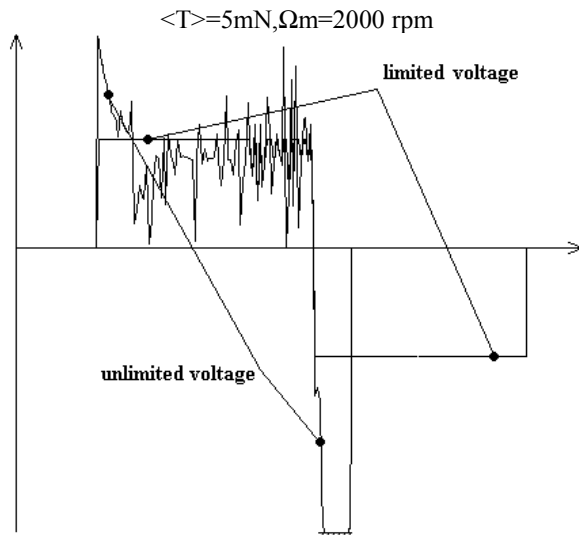

Fig[7]

Computed voltage waveform with and without voltage saturation

$\langle T \rangle = 5\text{mN}, \Omega_m = 2000\text{ rpm}$

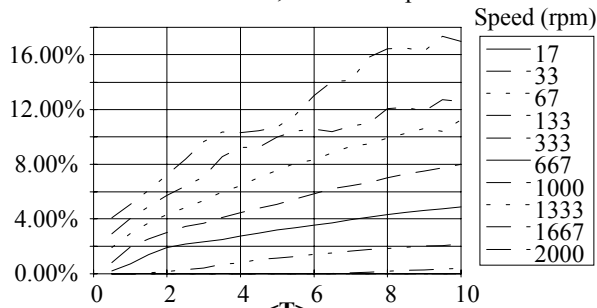

Fig [8]

Optimisation of the peak peak torque ripple

So we get two types of running: one when speed is weak enough (maximum value of the voltage is lower than U_{max}), another when the speed is such that voltage limitation is reached. In this last case, ripple torque appears. This phenomena leads two different optimizations: an optimization of copper losses if we don't reach saturation voltage, a minimisation of torque ripple if we reach saturation voltage. This phenomena explains the discontinuities noticed on the optimum angles of control.

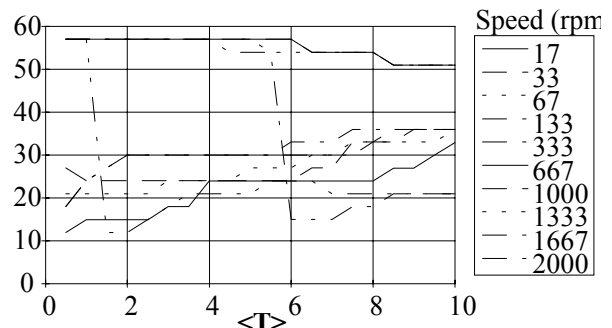

Fig [9]

Optimum angle A1

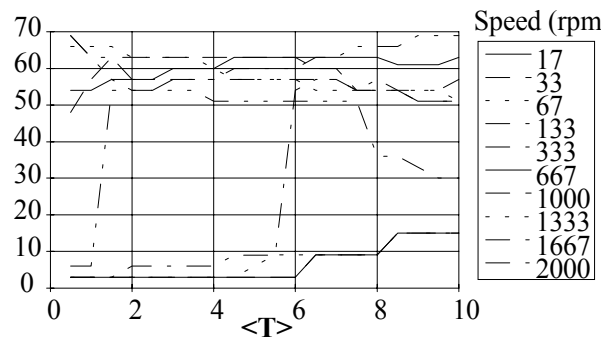
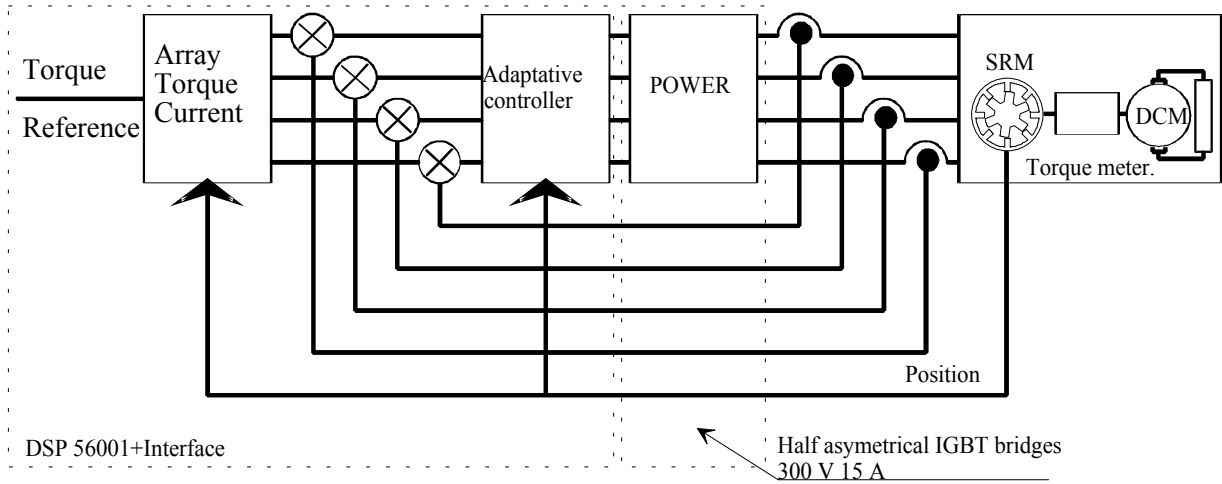

Fig [10]

Optimum angle A2

5. Experimental results

In order to validate our control model, we realised a test bench made up of the switched reluctance motor coupled to a DC motor and a torquemeter. The switched reluctance motor is supplied by four half asymmetrical IGBT bridges (fig[11]).



Fig[11]
Test bench

The current loop correction coefficients are modified in regard to the electrical position (the electrical time constant depends on the electrical position), all the real-time computation are made with a digital signal processor (DSP56001 MOTOROLA).

At low speed, we notice good correlation between reference current and drive current.

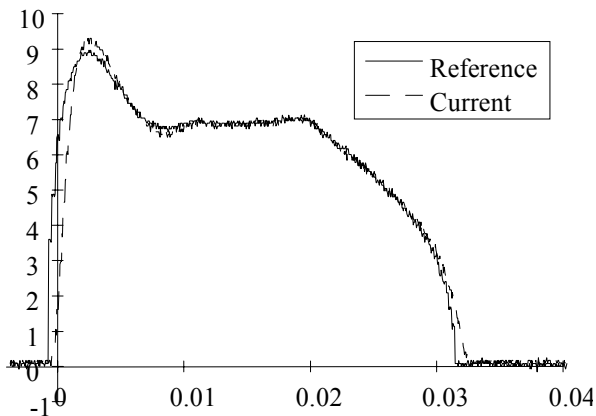

Fig [12]
C=6m.N, $\Omega=90\text{tr}/\text{min}$

If the speed increase, trailing errors and S.R.M. e.m.f lead to a current waveform distortion.

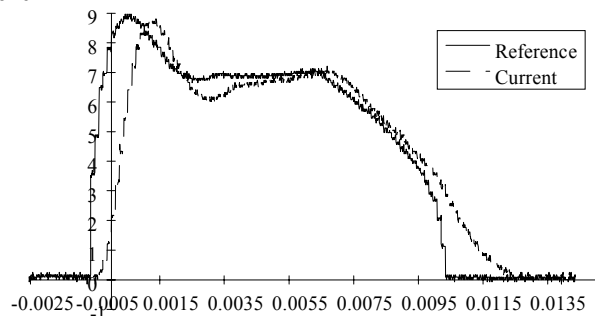
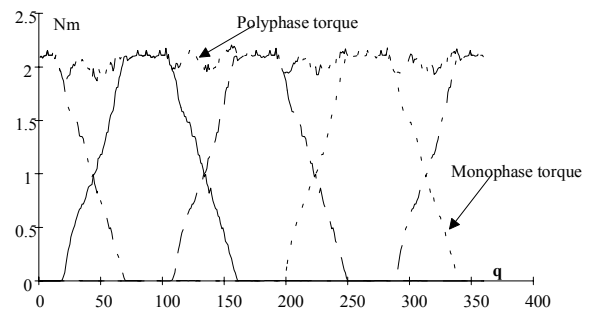
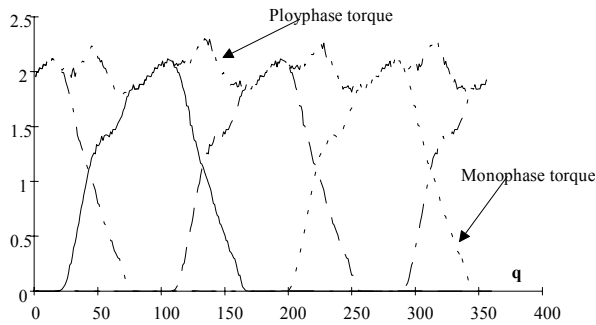

Fig [13]
C=6m.N, $\Omega=350\text{tr}/\text{min}$

It is possible to rebuilt monophasic and polyphasic torque waveform:



Fig[14]
Polyphasic torque waveform, C=2m.N,
 $\Omega=80\text{tr}/\text{min}$



Fig[15]
Polyphase torque waveform, C=2m.N,
 $\Omega=300\text{tr/min}$

So, it is possible to measure curves giving ripple ratio versus speed and torque.

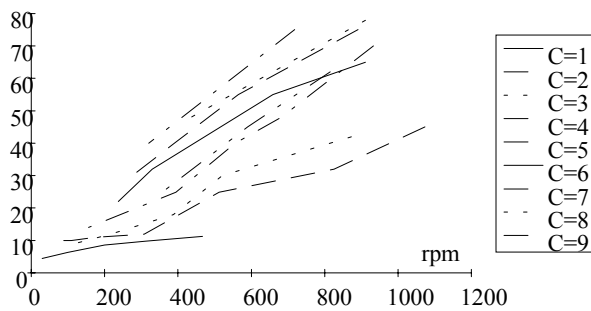

Fig[16]
Ripple torque (% of average torque) versus speed
(0-1200 rpm)

We notice that for speeds above 200 rpm, the peak to peak torque ripple ratio exceeds 15%, value which is far to be good. For lower speed values, the ripple ratio oscillates between 5 and 10%, values which are acceptable. Moreover, we should notice on figure 14 and 15, that torque ripple frequency is quite high.

Remark: The machine is four-phased, so the torque ripple first harmonic is in fact the fourth of monophase torque. That is why we will take interest in fourth harmonics only.

Instantaneous torque spectral analysis.

To have a good idea of eventual torque ripple consequences on a mechanic system, we studied the spectrum frequency of the ripple torque. High speed ripple are naturally filtered by the mechanic system, and only harmonics frequency equal to eventual mechanic resonance frequency should be dangerous.

We present Fourier transforms for C=1m.N and C=4m.N:

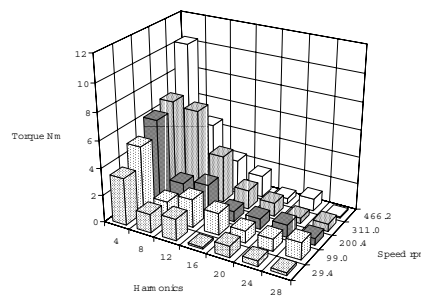

Fig[17]
Fourier transform of instantaneous torque, C=1m.N,
 $\Omega \in [30, 465]\text{rpm}$

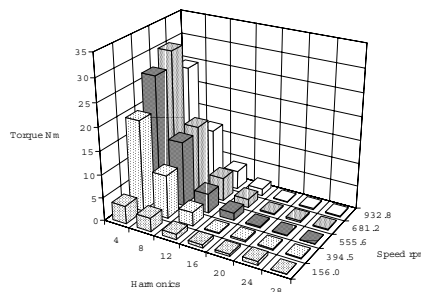

Fig[18]
Fourier transform of instantaneous torque, C=4m.N,
 $\Omega \in [150, 930]\text{rpm}$

So, it is possible to draw the torque ripple ratio evolution of 4th, 8th, 12th harmonics of the polyphase torque versus speed. (For torque value between 1 and 9 m.N):

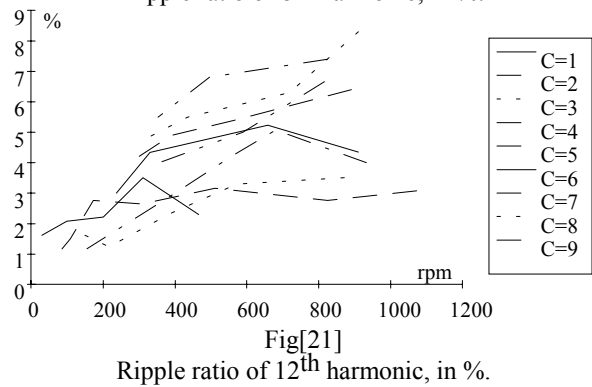
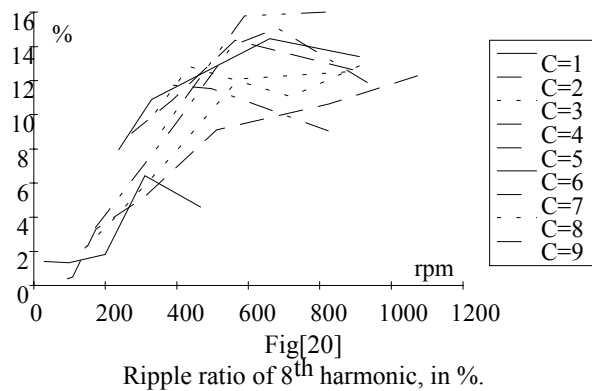
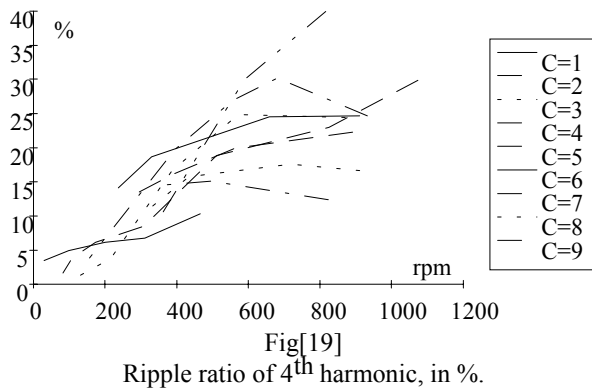

We notice that for low speed (<150 rpm), all harmonics of the ripple torque are lower 5%, which are acceptable values.

6. Conclusion

For low speed (<150 rpm), we obtain good values for the torque ripple. For greater speed, a current control is quickly transformed in a voltage control, because of power supply limits. The control mode we

have described is no longer usable, but it is possible to obtain torque ratio about 10%, with voltage control.[1].

We have notice 'classical control mode' limitations, if we want obtain no torque ripple for higher speeds. It is impossible to regulate complex current waveform with a quite non-linear drive. If we want better performance, it appears judicious to use more efficient control mode. For example, better result should be obtained by introducing an open loop induced voltage compensation. Nowadays, works on non-linear control mode of such machines are lead, and we hope that they will permit to reach the theoretical energetic limits (of the inverter and machine).

References

- (1) HASSINE, "Optimisation des paramètres de commande en tension des machines à réluctance variable autopilotées en régime permanent." Thèse, PARIS XI (1992)
- (2) CORDA, MASIC, BALAKAR, SELJUBAC, "Effect of the form of magnetic circuits on torque pulsations of switched reluctance motor", ICEM 90, Vol 1 ,pp 88-93
- (3) ROCHE, EGAN, MURPHY, "Intelligent 8096-multimode control of a variable reluctance motor drive", EPE 87, pp 917-922
- (4) WALLACE, TAYLOR, "Three-phase switched reluctance motors design to reduce torque ripple.", ICEM 90, Vol3, pp 783-787
- (5) WALLACE, TAYLOR, "Low-torque-ripple switched reluctance motors for direct-drive robotics.", IEEE transactions on robotics and automation, Vol 7, N°6, December 1991.
- (6) MULTON, GLAIZE, "Size power ratio optimization for the converters of switched reluctance motors". IMACS'TCI 90, Nancy.