



HAL
open science

Technoeconomic analysis of a methanol plant Based on gasification of biomass and Electrolysis of water

Lasse R. Clausen, Niels Houbak, Brian Elmegaard

► **To cite this version:**

Lasse R. Clausen, Niels Houbak, Brian Elmegaard. Technoeconomic analysis of a methanol plant Based on gasification of biomass and Electrolysis of water. *Energy*, 2010, 35 (5), pp.2338. 10.1016/j.energy.2010.02.034 . hal-00673669

HAL Id: hal-00673669

<https://hal.science/hal-00673669v1>

Submitted on 24 Feb 2012

HAL is a multi-disciplinary open access archive for the deposit and dissemination of scientific research documents, whether they are published or not. The documents may come from teaching and research institutions in France or abroad, or from public or private research centers.

L'archive ouverte pluridisciplinaire **HAL**, est destinée au dépôt et à la diffusion de documents scientifiques de niveau recherche, publiés ou non, émanant des établissements d'enseignement et de recherche français ou étrangers, des laboratoires publics ou privés.

TECHNOECONOMIC ANALYSIS OF A METHANOL PLANT BASED ON GASIFICATION OF BIOMASS AND ELECTROLYSIS OF WATER

Lasse R. Clausen^{a, *}, Niels Houbak^b, Brian Elmegaard^a

^a Section of Thermal Energy Systems, Department of Mechanical Engineering, The Technical University of Denmark (DTU), Nils Koppels Allé Bld. 403, DK-2800 Kgs. Lyngby, Denmark

^b DONG Energy A/S, A.C. Meyers Vænge 9, DK-2450 Copenhagen, Denmark

Received: xx

Abstract

Methanol production process configurations based on renewable energy sources have been designed. The processes were analyzed in the thermodynamic process simulation tool DNA. The syngas used for the catalytic methanol production was produced by gasification of biomass, electrolysis of water, CO₂ from post-combustion capture and autothermal reforming of natural gas or biogas. Underground gas storage of hydrogen and oxygen was used in connection with the electrolysis to enable the electrolyser to follow the variations in the power produced by renewables. Six plant configurations, each with a different syngas production method, were compared. The plants achieve methanol exergy efficiencies of 59-72%, the best from a configuration incorporating autothermal reforming of biogas and electrolysis of water for syngas production. The different processes in the plants are highly heat integrated, and the low-temperature waste heat is used for district heat production. This results in high total energy efficiencies (~90%) for the plants. The

* Corresponding author. Fax: +45 45884325, email: lrc@mek.dtu.dk

specific methanol costs for the six plants are in the range 11.8-25.3 €/GJ_{exergy}. The lowest cost is obtained by a plant using electrolysis of water, gasification of biomass and autothermal reforming of natural gas for syngas production.

1. Introduction

The production of alternative fuels for the transportation sector has the potential of being integrated with other production processes in order to reduce cost and increase the energy and exergy efficiency of the production. The Danish power company Elsam created the REtrol vision, which integrates the production of ethanol and methanol with heat and power production [1] and is the inspiration for this work. The plant modeled in this paper does, however, only produce methanol and district heating.

The modeled methanol plant uses biomass, natural gas and electricity for syngas production as suggested by the REtrol vision. These inputs are supplemented by biogas in order to be able to produce methanol solely based on renewable sources. The biomass input is gasified in a fluid bed gasifier. The natural gas and biogas input are reformed in an autothermal reformer. The electricity input is used to generate hydrogen (for the syngas) and oxygen (for the gasification and autothermal reforming) by water electrolysis. The use of electricity for the syngas production could be interesting if a significant part of the electricity produced for the grid is from intermittent, renewable sources, such as wind power. The electrolyser in the methanol plant could operate when surplus electricity is available in the grid and thereby help to stabilize the grid as well as utilize low cost electricity. The operation of the electrolyser could even be detached from the methanol plant by

introducing underground gas storages for hydrogen and oxygen², thereby enabling the rest of the methanol plant to run continuously. This configuration is investigated in the paper.

In the paper, six different plant configurations are investigated:

1. Plant E+B+NG is a reference plant based on the RETrol vision where biomass, electricity and natural gas are used for the syngas production.
2. Plant E+B only uses biomass and electricity to avoid the use of a fossil fuel. All the carbon in the biomass is utilized for methanol production.
3. Plant E+B+CCS is like the previous plant but utilizes all the oxygen from the electrolyser for gasification and uses CO₂ capture to create a syngas with a low concentration of CO₂, which is more suited for methanol production.
4. Plant E+NG is also a reference plant. This plant uses natural gas and electricity for the syngas production because natural gas is the most commonly used feedstock for methanol production.
5. Plant E+BG is like the previous plant but uses biogas instead of natural gas in order to produce methanol based on renewable sources.
6. Plant E+CO₂ only uses electricity and CO₂ for the syngas production. This plant could be used to stabilize the electricity grid as mentioned above.

The objective of this study was to compare the six plant configurations based on economy, thermal efficiencies and the extent of renewables used for the methanol production. The production costs of the methanol produced from the six plants are compared to relevant fuels.

For the economic evaluation of the modeled methanol plants, Denmark is used as a case of a modern, national energy system. This is because:

1. The RETrol vision is developed for the Danish energy system.

² Underground storage of hydrogen is used today [2], underground storage of oxygen has not been demonstrated yet but is referred to as an option in some studies (e.g. [3]).

2. Electricity from wind turbines accounts for 20% of the electricity production (in 2007) [4], and this figure is predicted to increase. Thus, the Danish system is an interesting case, because renewable sources account for a significant share of the electricity production.
3. There are high taxes on petrol [5], which means that methanol from renewable sources that is untaxed could be competitive.
4. District heating is used to a great extent in Denmark [4] (the byproduct from the modeled methanol plant is district heating).

The use of hydrogen from electrolysis together with gasification of biomass to produce a biofuel has also been investigated in [6,7,8,9]. In [8], the biofuel is synthetic natural gas (SNG). In [6,7,9], the biofuel is methanol. The plant investigated in [6] resembles plant E+B in this paper, and the plants investigated in [7,9] resemble plants E+B and E+B+CCS in this paper. However, neither the use of electrolysis together with autothermal reforming of a hydrocarbon feed for syngas production nor the use of gas storage for hydrogen and oxygen in connection with a methanol plant has been investigated. Combining gasification and autothermal reforming to avoid production of excess oxygen from the electrolysis is also a new concept generated from the RETrol vision. The production of methanol from biomass is, on the other hand, a well investigated field (e.g. [10,11]).

1.1 The RETrol vision

The RETrol³ vision (VEnzin-visionen in Danish) is a vision proposed by the Danish power company Elsam (now DONG Energy) and involves the integration of the heat and power production with production of fuel for the transportation sector [1]. In Denmark, heat and power production are

³ The word RETrol is a mix of the phrase “Renewable Energy” and the word “petrol”.

highly integrated – about 50% of the power is produced in cogeneration [4]. This integration of heat and power production saves fuel for the plants compared to production of heat and power separately, which is both an economical advantage and benefits the environment. By integrating transportation fuel production with the combined heat and power (CHP) plants, the plants increase the number of products from two (heat and power) to three (heat, power and transportation fuel), which would provide advantages in terms of being able to emphasize which product to produce, based on the demand from the market. Depending on what kind and how many different transportation fuels the plant would produce – e.g., methanol, dimethyl ether (DME) or ethanol - the integration opportunities are different. However compared to stand-alone plants, the plants should be able to receive economical and environmental advantages (due to efficiency increases).

In the REtrol vision, a methanol and ethanol plant is integrated with a CHP plant. Besides the exchange of heat at different temperatures, some of the integration opportunities lie between the ethanol and methanol production. A 2nd generation ethanol plant⁴ would produce a solid lignin residue that can be gasified in the methanol plant and used for methanol synthesis together with CO₂ and H₂, which are also byproducts from a 2nd generation ethanol production. If the ethanol plant includes a biogas plant, the biogas could also be used for methanol synthesis by reforming the biogas.

REtrol is thought to consist of petrol with a small percentage (5 – 10%) of ethanol and/or methanol. In the case of ethanol, the input to the production would be biomass (e.g., straw) and the conversion process would be biological. In the case of methanol, the input to the production would be biomass, electricity or natural gas. The biomass would be gasified to produce a syngas that could be catalytically converted to methanol. Electricity from renewable sources would be used in an

⁴ Production of ethanol from cellulosic material by fermentation (and other biological processes).

electrolyser to produce hydrogen for the syngas. Natural gas is, however, not a renewable energy source and could be replaced by biogas.

2. Design of the methanol plant model

The methanol plant model was designed with strong inspiration from the REtrol vision.

This means that the plant feedstocks are based on renewable energy sources and that the plant is flexible in the choice of feedstock: biomass, electricity, natural gas and biogas.

The plant was also designed with the goal of high energy/exergy efficiency, and the methanol efficiency is especially crucial.

The design and analysis of the methanol plant model was done with the thermal system simulation tool DNA⁵ [12,13]. The model of the methanol plant was developed for steady-state operation. The modeled methanol plant was used to investigate six different plant configurations, which are presented in section 3.

The designed methanol plant is different from a commercial methanol plant based on autothermal reforming of natural gas because of the added electrolyser and gasifier. In the modeled methanol plant, the syngas can be produced by three components: the electrolyser, the gasifier and the autothermal reformer (Fig. 1). The product gases from the three components are mixed together to form a syngas. Addition of CO₂ (from, e.g., carbon capture from a power plant or ethanol production) is possible in order to adjust the carbon/hydrogen ratio. The optimal carbon/hydrogen ratio depends on input concentrations of CO and CO₂. An optimal relation between CO, CO₂ and

⁵ Exergy calculations were also done by DNA using the method described in [14].

H₂ in the syngas can be extracted by the chemical reactions producing methanol given in Eqns. 1 and 2.

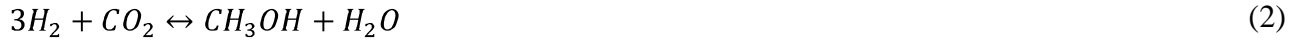

It can be seen that production of methanol from CO requires two moles of hydrogen for every mole of CO, but if methanol is produced by CO₂, three moles of hydrogen are required for every mole of CO₂. In Eq. 3, the Module M [15] is defined based on mole-fractions of CO, CO₂ and H₂ in the syngas. It can be seen that an M-value of 2 is optimal for methanol synthesis.

$$M = \frac{y_{H_2} - y_{CO_2}}{y_{CO} + y_{CO_2}} \quad (3)$$

The electrolyser and the gasifier supplement each other with regard to producing a syngas suited for methanol production. This is because the gasification gas is too carbon rich (M=0.9). By supplementing the gasification gas with hydrogen from the electrolyser, a syngas well suited for methanol synthesis is produced. Besides the production of hydrogen, the electrolyser also produces oxygen, which is used in the gasifier or the autothermal reformer.

Electrolysis of water and underground gas storage of hydrogen and oxygen

Alkaline electrolysis of water is used to generate hydrogen and oxygen. The electrolyser is modeled based on data for a large-scale, commercially available electrolyser of 2 MWe (485 Nm³-H₂/h). The electrolyser is operated at 90°C and atmospheric pressure and has an electricity consumption of 4.3 kWh/Nm³-H₂, which corresponds to an efficiency of 70% (LHV) [16]. Higher efficiencies are achieved with PEM or SOEC electrolysers, but these types of electrolysers are still under

development and it may take many years before they can compete economically with alkaline electrolyzers on a large scale (>50 MWe) [17].

In order to produce hydrogen and oxygen when electricity from renewables is available (or when the electricity price is low), underground gas storage of hydrogen and oxygen is assumed to be used. Other types of gas storage (e.g., compressed cylinders or metal hydrides) are not economical at the size needed⁶.

In the report that is the basis of this paper [18], the feasibility of using underground gas storage of hydrogen and oxygen in connection with a plant that utilizes hydrogen and oxygen (e.g., a methanol plant) was investigated. The calculations were based on historic electricity prices from western Denmark (from 2000 to 2006) where the installed capacity of wind turbines is about 20% of the total installed capacity. The cost for electrolyzers and underground gas storage used in the study are the same as used in this paper. It was shown that with today's electricity prices in western Denmark, electricity cost could be reduced by 5-18%, and total costs could be reduced by up to 12%⁷ by using gas storage to exploit daily variations in the electricity price. A gas storage size corresponding to about five days of operation and an electrolyser capacity corresponding to about twice the capacity needed if gas storages were not used were the most economical. These sizes of the electrolysis plant and underground gas storage are thus used in this paper. It should be noted that if the electrolysis plant operates at a partial load (e.g. if the gas storages are filled), higher conversion efficiencies are achieved: at about 300-377 Nm³-H₂/h (62-78% load), the electricity consumption drops to 4.1 kWh/Nm³-H₂ (73% efficiency) [16]. This means that at the electricity price used in this paper (40 €/MWh), about the same economics for the electrolyser plant are achieved if operating at 4.3 kWh/Nm³-H₂ (100% load) as when operating at 4.1 kWh/Nm³-H₂ (62-78% load) at a larger

⁶ In [2], it is stated that if the storage requirement exceeds 1,300 kg of hydrogen, underground gas storage should be considered. The amount of gas storage needed is 0.1-0.9 million kg of hydrogen.

⁷ These figures refer to calculations done where the model only had knowledge of historic electricity prices. If the model is used to optimize production for a given year and the model knows all the electricity prices for that year at the start of the calculations, even greater reductions in cost can be achieved.

electrolysis plant. The extra capital needed for the larger electrolysis plant is saved by lower electricity costs.

Gasification of biomass

The feedstock for the biomass gasifier is wood. Before being fed to the gasifier, the wood is dried in a steam dryer. The gasifier is modeled as a modified Low-Tar BIG gasifier, which is a two-stage fluidized bed gasifier at atmospheric pressure with very low tar content in the gasification product gas [19]. The gas exiting the gasifier is at 800°C with a composition given by an assumption of chemical equilibrium⁸ at this temperature. The gas is cooled to 60°C before the gas cleaning by preheating oxygen, superheating steam and heating district heating water. The superheated steam is used for steam injection in the gasifier and for steam drying of biomass.

Autothermal reforming of natural gas or biogas

Natural gas or biogas is after a desulfurization process, reformed in an autothermal reformer (ATR) to a reformat gas consisting of H₂, CO, CO₂ and H₂O. The heat needed for the reforming is created by partially oxidizing the fuel with oxygen. The composition of the reformat gas is calculated by assuming chemical equilibrium at the exit where the temperature is 950 °C and the pressure is 10 bar. The steam/fuel mass-ratio is set to give an adequately low methane content in the reformat gas (0.5-0.6 mole-%). In the case of natural gas, this ratio is set to 1, and for biogas it is set to 0.2. This corresponds to a steam/carbon mole-ratio of 0.89 for natural gas and 0.29 for biogas (the ratio is 0.44 if the carbon in the CO₂ in the biogas is disregarded). Because the reforming in the case of biogas is mostly done with the CO₂ present in the biogas, a CO₂-reforming catalyst is most likely needed in order to avoid problems with coke formation. The CO₂ reforming catalysts are under

⁸ Typically, the methane content will be higher than what is given by chemical equilibrium at this temperature and pressure [20]. A catalyst could be added at the exit to convert the methane.

development [21]. The oxygen consumption of the ATR is calculated by simulation, and the O/C mole-ratio is 0.94 in the natural gas case and 0.63 in the biogas case (the ratio is 0.97 if the carbon in the CO₂ in the biogas is disregarded). The gas exiting the reformer is cooled by preheating oxygen and natural gas/biogas and by generating steam for the reformer.

Gas cleaning

Gas cleaning of the gasification gas consists of removal of particles, sulfur components and in some cases CO₂. Particle removal is done by a cyclone and/or a filter. Sulfur removal is either done by a zinc oxide filter (as with natural gas) with COS hydrolysis upstream to convert COS to H₂S or by a scrubber. CO₂ removal is done by an amine scrubber^{9,10}.

Methanol synthesis

The syngas is compressed to 144 bar by intercooled compressors before entering the synthesis reactor. The reactor operates at 235°C, and the composition of the outlet gas is calculated by assuming chemical equilibrium. The gas from the methanol reactor is cooled, and condensation of methanol and water occurs. 95% of the unconverted gas is recirculated to the synthesis reactor, and the remaining 5% is purged. The chemical reactions producing methanol from CO, CO₂ and H₂ are given in Eqns. 1 and 2. Since a mixture of CO and CO₂ is used to produce methanol, the module M given in Eq. 3 is used to characterize how well a gas is suited for methanol synthesis. The hydrogen content of the unconverted syngas is set to 30 mole% instead of setting the module M. This is done to reduce the loss of hydrogen in the 5% of unconverted syngas that is purged. The hydrogen from

⁹ The heat requirement for CO₂-capture with an amine solvent is not accounted for. From [22], this is 2.7-3.2 MJ/kg-CO₂-captured. Plant 3 is the only plant that uses CO₂-capture, and the amount of CO₂ captured is 4.6 kg/s. This gives about 14 MJ/s of heat needed. For comparison, the amount of heat generated when cooling the gas from the gasifier is 27 MJ/s.

¹⁰ 100% CO₂ removal is assumed. For a real CO₂ capture process with an amine solvent, the amount of CO₂ captured is 85-90% [22].

the electrolyser is the most expensive syngas component; therefore the hydrogen content in the syngas is the lowest possible without significantly affecting the methanol production. To achieve 30 mole% of hydrogen in the unconverted syngas, the module for the syngas is 1.3-1.8 in the simulations, depending on the CO/CO₂ ratio in the syngas. M=1.3 when only CO₂ is in the syngas, and M=1.8 when only CO is in the syngas.

Distillation

The heat generated by the synthesis process is used for the distillation. It is assumed that only water and methanol is in the feed for the distillation column. The column is pressurized to 3.5 bar, which corresponds to a temperature of 100°C in the condenser.

Heat integration

The configuration of the methanol plant is designed to give high total energy efficiency. This is achieved by utilizing the waste heat generated in different areas of the plant: waste heat from the electrolyser, from the condenser of the distillation column and from condensing the steam produced in the steam dryer is used for district heating (Fig. 2). Waste heat from the compressor intercooling is used for district heating and steam drying of biomass.

In Table 1, all the parameters used in the simulation model are shown.

For details about the modeling of the methanol plant, see the report in [18].

3. Methanol plant configurations

The model of the methanol plant has five sources for production of syngas for methanol synthesis. These are: gas from gasification of biomass, reformat gas from autothermal reforming of natural gas or biogas, hydrogen from water electrolysis and CO₂ from an ethanol plant or from carbon capture from a power plant. On top of this, CO₂ capture can be used to reduce the carbon content of the gasification gas. In order to determine which combination of these sources produces the most efficient or cost-effective methanol plant, six plant configurations are investigated (Fig. 3). All six plant configurations utilize electrolysis because oxygen from the electrolysis plant is needed for gasification and autothermal reforming.

Plant E+B+NG

The syngas consists of hydrogen from electrolysis of water, gasification gas generated from biomass and reformat gas generated from natural gas. The oxygen generated in the electrolysis is used for the gasification of biomass and the autothermal reforming of natural gas.

Plant E+B

The syngas consists of hydrogen from electrolysis of water and gasification gas generated from biomass. The oxygen generated in the electrolysis is used for the gasification of biomass. The oxygen not used for the gasification is vented or used outside the plant.

Plant E+B+CCS

This plant is similar to plant E+B but with CO₂ capture to reduce the carbon content in the gasification gas. The size of the electrolysis plant is reduced compared to plant E+B. All the oxygen produced is used for gasification. The CO₂ captured can be used for commercial purposes, stored underground or vented since the CO₂ is produced from biomass. If the CO₂ is stored, it could be

used for methanol production together with hydrogen from the electrolysis at times when the electricity is cheap.

Plant E+NG+CO₂

The syngas consists of hydrogen from electrolysis of water, reformat gas generated from natural gas and CO₂ from post-combustion capture at a power plant. The oxygen generated in the electrolysis is used for the autothermal reforming of natural gas.

This plant configuration is modeled because it is based on natural gas, which is the most commonly used resource in commercial methanol plants [23].

Plant E+BG

This plant is similar to plant E+NG but biogas is used instead of natural gas, and since CO₂ is present in the biogas, CO₂ does not have to be added to the syngas.

Plant E+CO₂

The syngas consists of hydrogen from electrolysis of water and CO₂ from post-combustion capture at a power plant. The oxygen generated in the electrolysis is vented or used outside the plant.

Since the plants described above have several sources for the production of syngas, the ratio(s) between the different sources has to be set. For plants E+B, E+BG and E+CO₂ that use two sources for syngas production, the ratio between the two sources is determined by the hydrogen content specified for the unconverted syngas. In the case of plant 2, this means that 0.6 kg/s of hydrogen from the electrolyser and 17.8 kg/s of biomass to the gasifier will produce an unconverted syngas with an H₂ content of 30 mole%. For plants E+B+NG and E+NG+CO₂ that use three sources for

syngas production, the ratios between the three sources are determined by the hydrogen content specified for the unconverted syngas and the requirement that all of the oxygen from the electrolysis is used for gasification or autothermal reforming. Plant E+B+CCS only uses two sources for syngas production, but since CO₂ capture is also used, the amount of CO₂ captured and the size of the electrolyser are fitted so that there is no excess oxygen from the electrolyser while still achieving the specified hydrogen content in the unconverted syngas.

4. Results

4.1 Process simulation results

The model of the methanol plant was used to simulate the six plant configurations. All six plants were fixed to produce a methanol output of 10.3 kg/s (205 MW_{LHV})¹¹. In Table 2 and Table 3, detailed material balances are presented for the plants. These tables show the differences between the plants in syngas composition and flows. From Table 3, it can be seen that the CO₂/CO ratio of the syngas affects the flows in the methanol synthesis loop. The higher the CO₂/CO ratio, the higher the amount of unconverted syngas that will be recirculated because the conversion rate per pass is lower for CO₂ than for CO. This ultimately leads to a greater loss of unconverted syngas.

The main difference between the six plant configurations is the kind of energy inputs used for the syngas production. The different energy inputs are electricity, biomass, natural gas and biogas. In Table 4, the distribution between these inputs is shown. It can be seen from this table that the electricity consumption for electrolysis for plant E+B+CCS is considerably lower than for plant E+B. This is because of the use of carbon capture in plant E+B+CCS that reduces the need for

¹¹ The output corresponds to one plant being able to cover the addition of methanol to petrol used for Danish road transport so that 7% [1] of the energy content in the mixture would be methanol. Petrol used for Danish road transport in 2004: 84.6 PJ [24].

hydrogen from the electrolysis. Table 4 also shows the amount of input energy to the plants that comes from renewable energy sources. If the electricity is regarded as a renewable energy source, all of the plants that do not use natural gas only use energy from renewable sources. If electricity is not regarded as a renewable energy source, plant E+B+CCS is the plant where most of the input energy is from renewable sources (75%).

In addition to producing methanol, the plants also produce heat for district heating. Table 5 shows the amount of methanol and district heating produced together with important plant efficiencies. It can be seen that plant E+BG has the highest methanol exergy efficiency of 72%, and the other plants (except E+CO₂) have only slightly lower methanol exergy efficiencies (68-71%). Total energy efficiencies for all the plants except E+CO₂ are around 90%. The efficiencies for plant E+CO₂ are lower compared to the efficiencies of the other plants: the methanol exergy efficiency is 59%, and the total energy efficiency is 86%. The reason why plant E+CO₂ has lower methanol efficiencies is mainly due to the 70% efficiency of the electrolyser, which is lower than the 93% cold gas efficiency of the gasifier and the 95-96% efficiency of the autothermal reformer.

4.2 Cost estimation

In order to estimate the investment of the methanol plants investigated, the investment of some major plant areas was estimated and shown in Table 6. We found that the gasification part is much more expensive than the other syngas-producing parts, namely the electrolysis and the autothermal reforming parts. The investment costs for the six plant configurations are 175- 310 M€.

In Fig. 4, the cost distribution between electricity, biomass, capital cost, etc. can be seen for all six plant configurations (the prices assumed for electricity, biomass, etc. can be seen in Table 7). The largest cost areas for plants E+BG and E+CO₂ are biogas and electricity, respectively; for the other

plants, the capital cost is the largest cost area. It is also clear by comparing costs for plants E+B and E+B+CCS that 20 M€/year (43-23) is saved in electricity costs for the electrolyser by using CO₂ capture with a cost of 9 M€/year¹² (4 M€/year for CO₂ capture and 5 M€/year for increased biomass use).

The total costs shown in Fig. 4 are to be covered by the produced methanol and district heating (Fig. 5). The specific income of district heating is estimated to be 7 €/GJ. The cost not covered by the district heating is placed on the produced methanol.

In Table 8, the specific methanol costs for all six plant configurations are compared to other fuels. It is clear from this table that the production cost is lowest for plants E+B+NG and E+B+CCS and that plant E+CO₂ has the highest production cost by far – more than twice as high as plants E+B+NG and E+B+CCS. This difference is mainly due to the difference in the electricity consumption. Actually, 23% (plant E+B+CCS) to 65% (plant E+CO₂) of the total costs for the six plant configurations are for electricity. In Fig. 6, the relation between the electricity price and the methanol production cost is shown. We see that all plants except E+CO₂ have similar production costs. The figure indicates that the average electricity price has to be below 20 €/MWh before plant E+B produces cheaper methanol than plant E+B+CCS. Above 20 €/MWh, it is more cost-effective to remove carbon from the gas from the gasifier and thereby reduce the need for expensive hydrogen from the electrolyser. Below 20 €/MWh, it is more cost-effective to keep all the carbon in the gas from the gasifier and use the required amount of hydrogen from the electrolyser. The figure also shows that the average electricity price has to be as low as 3-8 €/MWh before plant E+CO₂ can compete with the other five plants. However, if regulation of the electricity grid is needed on a large scale (hundreds of MWe), e.g., if 50% of the electricity production is from wind turbines, as suggested for Denmark [25], plant E+CO₂ seems to be the only possible option out of the six plants

¹² Disregarding the potential income for the unused oxygen from the electrolyser in plant E+B.

and would produce better thermal efficiencies by producing methanol from the stored hydrogen than a plant generating electricity from the stored hydrogen by fuel cells.

From Table 8, it can also be seen that the methanol production cost for plants E+B+NG and E+B+CCS (11.8 and 12.4 €/GJex) can compete with the production cost of 2nd generation ethanol (12.0 €/GJex) but not with the current commercial methanol price (7.1 €/GJex).

Table 9 presents a summary of some of the main characteristics of the six plant configurations. We find that plants E+B+NG and E+B+CCS would be most appropriate for the current Danish energy system and that plant E+CO₂ will have a high potential in the future system with a high penetration of wind power. This conclusion may apply to other systems as well, but different shares of energy sources may have an influence.

5. Conclusion

In connection with Elsam's RETrol vision six methanol plants were designed to obtain optimal energy and exergy efficiencies while maintaining reasonable economics.

The design of the plants was based on the use of sustainable energy sources for the methanol production. All six plants used electricity from renewables to produce hydrogen for syngas production and oxygen for either gasification of biomass or autothermal reforming of a hydrocarbon gas. Underground gas storage of hydrogen and oxygen was used to ensure the constant production of methanol while the operation of the electrolyser followed the daily variations in the electricity price induced by the fluctuating production by renewables. The modeling showed methanol exergy efficiencies of 68-72% for five of the six plants. Only plant E+CO₂ that uses electricity as the only exergy source has a significantly lower methanol exergy efficiency of 59%. By heat integrating the

different plant processes and using the waste heat from the methanol plant for district heating, the total energy efficiency reached more than 90% for all plants except E+CO₂.

The estimated methanol costs were 11.8-14.6 €/GJ_{ex} for all plants except E+CO₂ (25.3 €/GJ_{ex}). The methanol costs achieved for some of the plant configurations can compete with the production cost of 2nd generation ethanol (12.0 €/GJ_{ex}) but not with the current commercial methanol price (7.1 €/GJ_{ex}).

It was also shown that the electricity price has a significant effect on the production cost since 23-65% of the total costs for the six plant configurations are due to electricity consumption.

Of the six plant configurations, plants E+B+NG and E+B+CCS are the most appropriate for the current energy system. Plant E+CO₂ may be competitive in the future system.

References

[1] DONG Energy A/S. Renewable energy within the transport sector (The REtrol/VEnzin vision).

www.elsamvpp.com/page.dsp?area=1422, accessed at 2/17/2010.

[2] Amos WA. Costs of Storing and Transporting Hydrogen, report. Golden, Co: National Renewable

Energy Laboratory, 1998. http://www.hydrogen.energy.gov/analysis_repository/project.cfm/PID=114, accessed at 2/17/2010.

[3] Forsberg CW. Economics of meeting peak electricity demand using hydrogen and oxygen from base-load nuclear or off-peak electricity. Nuclear technology 2009; 166(1): 18-26.

[4] The Danish Energy Authority. Energy Statistics 2007.

<http://www.ens.dk/en-US/Info/publications/Sider/Forside.aspx>, accessed at 2/17/2010.

[5] The Danish Energy Authority. Energy taxes (Energiavgiftsatserne)

<http://www.ens.dk/da->

[DK/Info/TalOgKort/Statistik_og_noegletal/Energipriser_og Afgifter/Energiavgifter/Sider/Forside.aspx](http://www.ens.dk/da-DK/Info/TalOgKort/Statistik_og_noegletal/Energipriser_og Afgifter/Energiavgifter/Sider/Forside.aspx)

(in danish), accessed at 2/17/2010.

[6] Mignard D, Pritchard C. On the use of electrolytic hydrogen from variable renewable energies for the enhanced conversion of biomass to fuels. *chemical engineering research and design* 2008; 86(5):473–487.

[7] Specht M, Bandi A, Baumgart F, Muray CM, Gretz J. Synthesis of methanol from biomass/CO₂ resources. In: Riemer P, Elliasson B, Wokaun A, editor. *Greenhouse Gas Control Technologies*, Interlaken, Switzerland. Oxford: Elsevier, 1999, p. 723–727.

[8] Gassner M, Maréchal F. Thermo-economic optimisation of the integration of electrolysis in synthetic natural gas production from wood. *Energy* 2008;33(2):189-198.

[9] Ouellette N, Rogner HH, Scott DS. Hydrogen from remote excess hydroelectricity. Part II: Hydrogen peroxide or biomethanol. *Int. J. Hydrogen Energy* 1995;20(11):873-880

[10] Sues A, Juraščík M, Ptasinski K. Exergetic evaluation of 5 biowastes-to-biofuels routes via gasification. *Energy*, in press, available online 2009.

[11] Hamelinck CN, Faaij APC. Future prospects for production of methanol and hydrogen from biomass, report NWS-E-2001-49. Utrecht, The Netherlands: Utrecht University, Copernicus Institute, 2001.

http://www.mtholyoke.edu/courses/tmillet/course/geog_304B/e2001-49.pdf, accessed at 1/27/2010.

[12] Elmegaard B, Houbak N. DNA – A General Energy System Simulation Tool, in: J. Amundsen et al., editors. *SIMS 2005*, 46th Conference on Simulation and Modeling, Trondheim, Norway. Tapir Academic Press, 2005. p. 43-52.

- [13] Homepage of the thermodynamic simulation tool DNA. <http://orbit.dtu.dk/query?record=231251>. Technical University of Denmark (DTU). Accessed at 2/17/2010.
- [14] Bejan A, Tsatsaronis G, Moran M. Thermal design & optimization. John Wiley and Sons Inc., 1996.
- [15] Steynberg A, Dry M. Fischer-Tropsch technology. Elsevier, 2004. page 315.
- [16] Danish Energy Authority, Elkraft System and Eltra. Technology data for electricity and heat generating plants. 2005. ISBN: 87-7844-502-7 (web edition: 87-7844-503-5).
www.energinet.dk/NR/rdonlyres/4F6480DC-207B-41CF-8E54-BF0BA82926D7/0/Teknologikatalog050311.pdf,
accessed at 2/17/2010.
- [17] Kruse B, Grinna S, Buch C. Hydrogen - Status and Possibilities, report no. 6. The Bellona foundation, 2002.
http://bellona.org/filearchive/fil_Hydrogen_6-2002.pdf, accessed at 2/17/2010.
- [18] Clausen LR. Design and modeling of a methanol plant for the REtrol vision (Design og modellering af metanolanlæg til VEnzin-visionen), report. Kgs. Lyngby, Denmark: Technical University of Denmark (DTU), 2007 (in danish). <http://orbit.dtu.dk/getResource?recordId=256657&objectId=1&versionId=1>, accessed at 2/17/2010.
- [19] Andersen L, Elmegaard B, Qvale B, Henriksen U, Bentzen JD, Hummelshøj R. Modelling the Low-Tar BIG gasification concept. In: The 16th International Conference on Efficiency, Cost, Optimization, Simulation, and Environmental Impact of Energy Systems (ECOS), Technical University of Denmark (DTU), Denmark. 2003. p. 1073-1079.
- [20] Ahrenfeldt J, Henriksen U, Jensen TK, Gøbel B, Wiese L, Kather A, Egsgaard H. Validation of a Continuous Combined Heat and Power (CHP) Operation of a Two-Stage Biomass Gasifier. Energy & Fuels 2006;20(6):2672-2680.
- [21] Gaoa J, Houa Z, Liub X, Zengc Y, Luob M, Zhenga X. Methane autothermal reforming with CO₂ and O₂ to synthesis gas at the boundary between Ni and ZrO₂. Int. J. Hydrogen Energy 2009;34(9):3734-3742

- [22] IPCC. IPCC Special Report on Carbon Dioxide Capture and Storage. 2005
http://www.ipcc.ch/publications_and_data/publications_and_data_reports_carbon_dioxide.htm, accessed at 2/17/2010.
- [23] The Methanol Institute (MI). Methanol production.
<http://www.methanol.org/contentIndex.cfm?section=methanol&topic=factSheets&title=Methpr>, accessed at 2/17/2010.
- [24] The Danish Energy Authority. Energy Statistics: Construct your own tables and graphs.
http://www.ens.dk/en-US/Info/FactsAndFigures/Energy_statistics_and_indicators/Annual%20Statistics/Construct%20your%20own%20tables%20and%20graphs/Sider/Forside.aspx, accessed at 2/17/2010.
- [25] Xu Z, Gordon M, Lind M, Østergaard J. Towards a Danish Power System with 50% Wind - Smart Grids Activities in Denmark. In: IEEE Power & Energy Society General Meeting. 2009. p. 1-8.
<http://orbit.dtu.dk/getResource?recordId=251984&objectId=1&versionId=1>, accessed at 2/17/2010.
- [26] Hydrogen Technologies (a subsidiary of StatoilHydro). Water electrolyzers. www.electrolysers.com/, accessed at 2/17/2010.
- [27] Enerdry. Steam dryer economics. 2003. <http://www.enerdry.com/index.php?id=489>, accessed at 2/17/2010.
- [28] Choren Industries GmbH. Power and heat from biomass.
http://www.choren.com/dl.php?file=Electricity_and_heat_from_biomass_6.pdf , accessed at 2/17/2010.
- [29] Fleisch TH, Sills RA, Briscoe MD. Emergence of the Gas-to-Liquids Industry: a Review of Global GTL Developments. Journal of Natural Gas Chemistry 2002;11:1-14.
- [30] DONG Energy A/S. Energy Together: Scenario 1 – The free market (det frie marked). 2004. Electricity price:

http://www.energyserver.net/ET1/Default%20inkl%20CO2/_html/Default%20Scenario%201.htm#Elpriser, accessed at 1/31/2007.

Natural gas price:

<http://www.energyserver.net/ET1/Default%20inkl%20CO2/Default%20Scenario%201.xls>, accessed at 1/31/2007.

(in Danish)

[31] Danish District Heating Association (Dansk Fjernvarme). District heating prices in Denmark for 2008 (fjernvarmeprisen i Danmark 2008).

<http://www.danskfjernvarme.dk/Forside/StatistikOgDriftsdata/~media/Medlemmer/Cirkul%C3%A6rer/2008/Notat%202008%20varmeprisen%202596%2008.ashx> (in Danish), accessed at 2/17/2010

Site in English: <http://www.danskfjernvarme.dk/In%20English.aspx>, accessed at 2/17/2010

[32] Methanex (worlds largest methanol producer). Commercial methanol price in Europe. Valid July 1- September 30, 2009. www.methanex.com/products/methanolprice.html, accessed at 2/17/2010

[33] Biogasol. Cost of 2nd generation ethanol. www.biogasol.dk, accessed at 2/17/2010

[34] Kreutz TG, Larson ED, Liu G, Williams RH. Fischer-Tropsch Fuels from Coal and Biomass, report. Princeton, New Jersey: Princeton Environmental Institute, Princeton University, 2008. <http://www.princeton.edu/pei/energy/publications>, accessed at 2/17/2010

Figure list:

Fig. 1. Simplified flow sheet for the methanol plant model used to generate the six plant configurations.

Fig. 2. Heat integration in the methanol plant model.

Fig. 3. Flow sheets showing the differences between the six plant configurations.

Fig. 4. Production cost distribution for the six plant configuration

Fig. 5. Annual production costs of methanol and district heating.

Fig. 6. Methanol cost as a function of the electricity price.

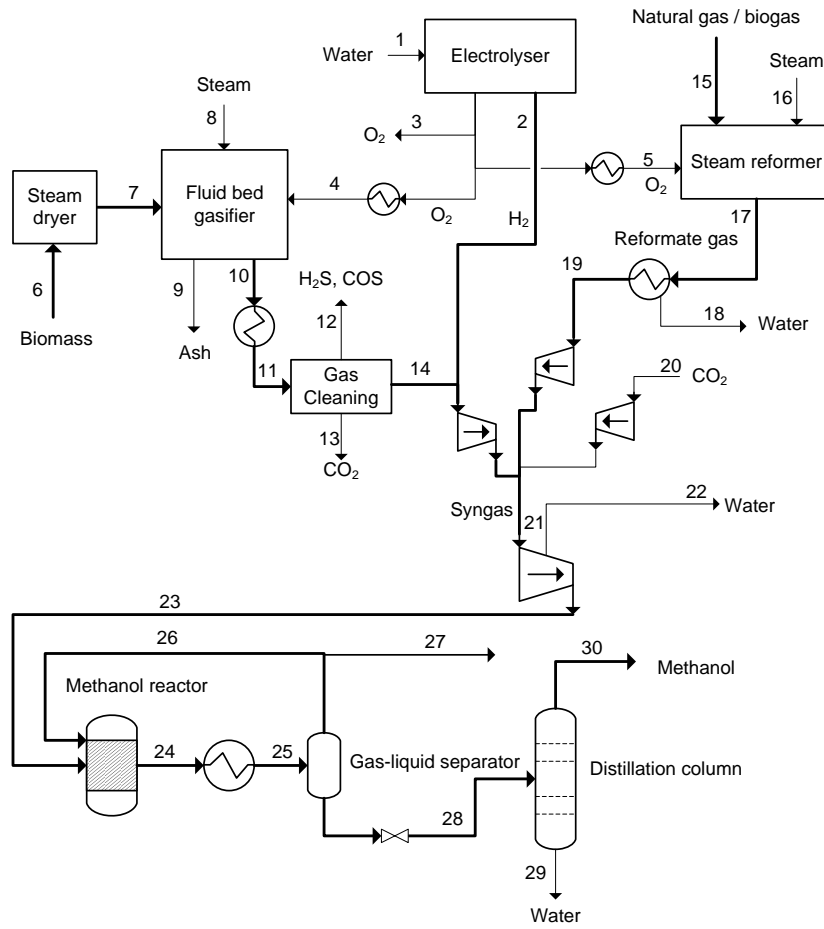

Fig. 1. Simplified flow sheet for the methanol plant model used to generate the six plant configurations.

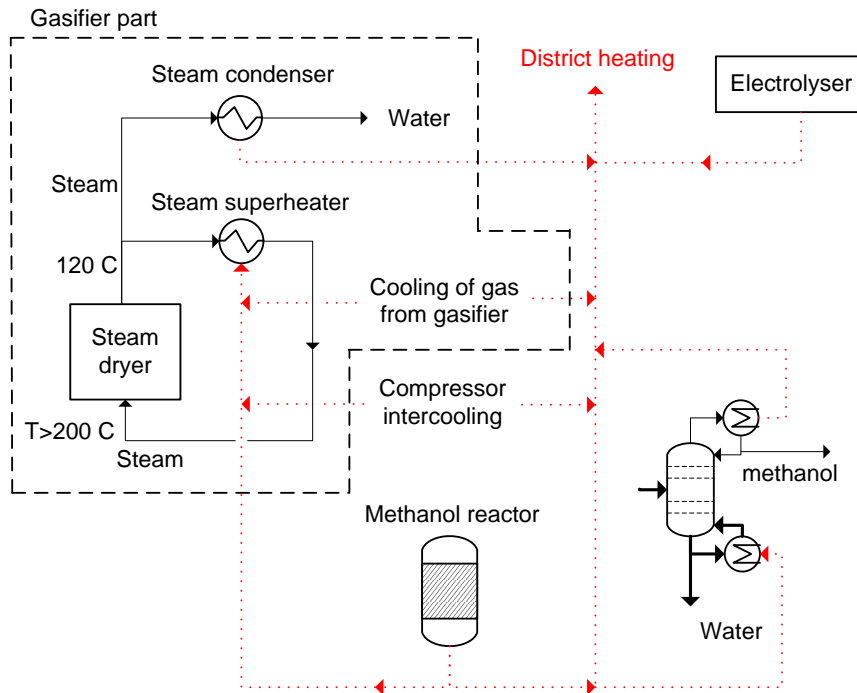

Fig. 2. Heat integration in the methanol plant model.

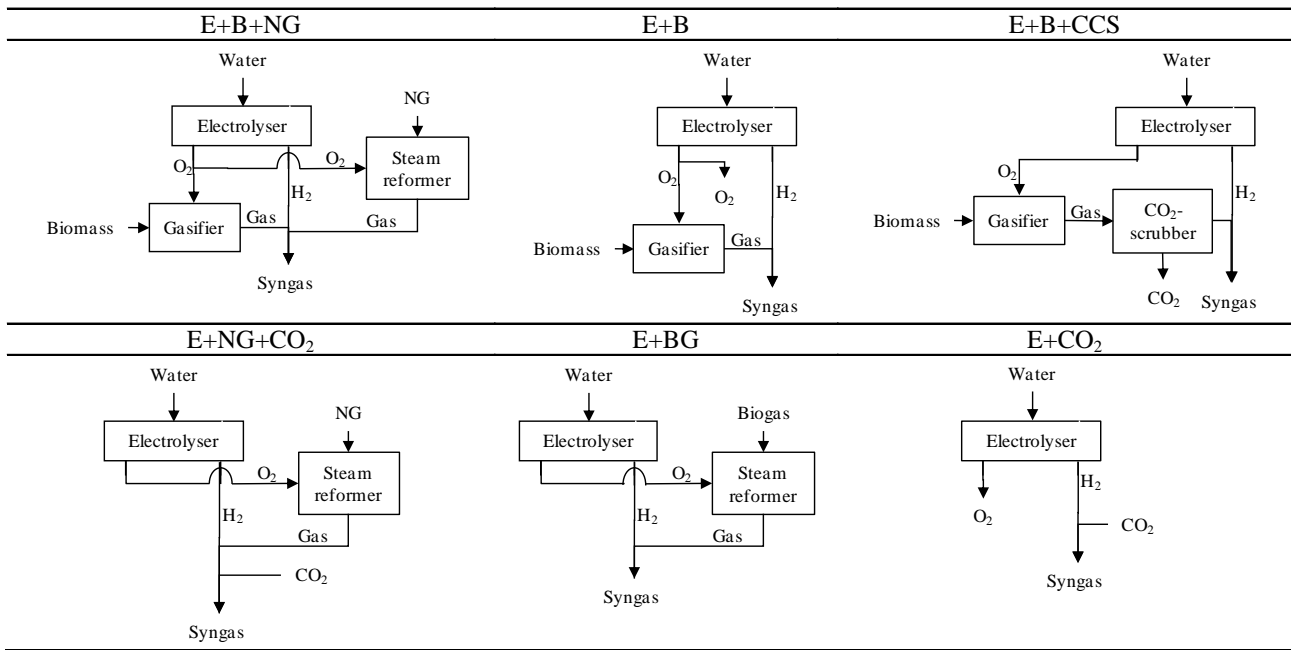

Fig. 3. Flow sheets showing the differences between the six plant configurations.

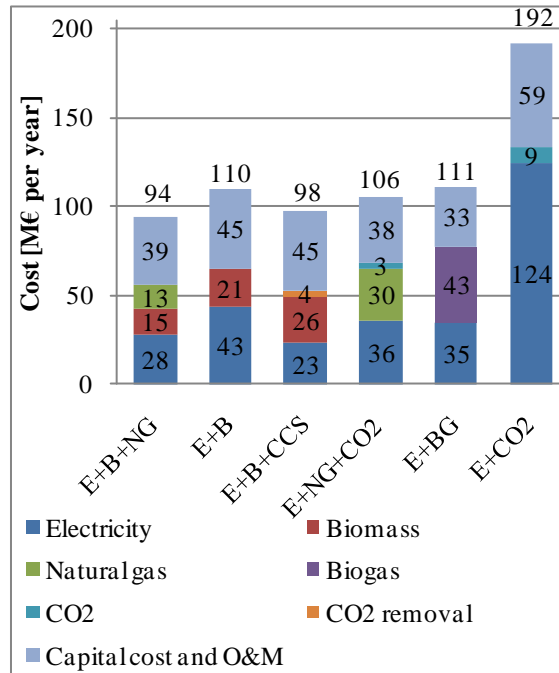

Fig. 4. Production cost distribution for the six plant configuration

8000 operation hours per year are assumed. The costs are calculated based on the information given in Table 4 (consumption data, Table 2 for the consumption of CO₂ and for the amount of CO₂ captured), Table 7 (prices) and the following. The specific cost of CO₂ capture is assumed to be 30 €/ton-CO₂ [16]. The capital cost per year is calculated as 15% of the total investment [34], and 4% of the total investment is used for O&M per year [34].

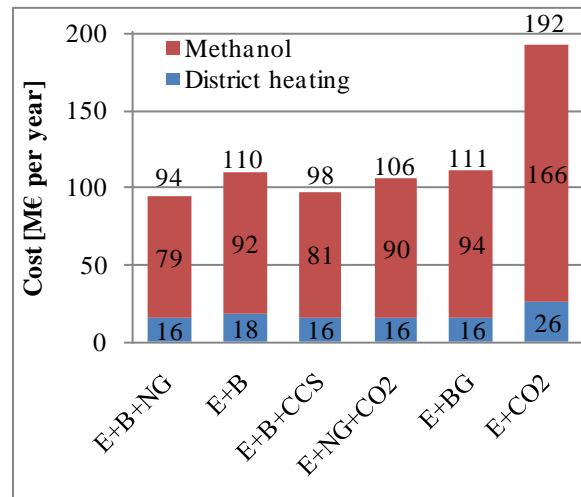

Fig. 5. Annual production costs of methanol and district heating.

The total cost seen at the end of each bar matches the total cost seen in Fig. 4.

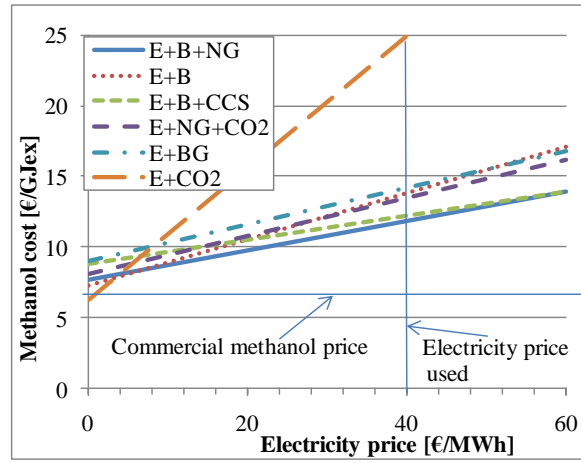

Fig. 6. Methanol cost as a function of the electricity price.

Table 1

Parameters used for the plant simulations.

| | |
|--|---|
| Electrolyser | |
| Efficiency | 70% |
| Temperature | 90°C |
| Steam dryer | |
| Feedstock (Wood) | 3.05% H, 18.86% O, 25.03% C, 0.005% S, 0.30% N, 0.205% Ar, 2.55% ash, 50% H ₂ O. 9.64 MJ/kg |
| Outlet water content | 5% (mass) |
| Steam exit | 120°C |
| Gasifier | |
| Carbon conversion | 100% |
| Steam/fuel mass-ratio | 0.2 ^a |
| Gas exit | 800°C |
| Gas cooling | |
| Exit temperature | 60°C |
| Autothermal reformer | |
| Feedstock (Natural gas) | 91.12% CH ₄ , 0.31% N ₂ , 0.56% CO ₂ , 5.03% C ₂ H ₆ , 1.84% C ₃ H ₈ , 0.47% C ₄ H ₁₀ , 0.23% C ₅ H ₁₂ , 0.44% of 8 higher hydrocarbons. 48.5 MJ/kg |
| Feedstock (Biogas) | 65% CH ₄ , 35% CO ₂ . 20.2 MJ/kg |
| Pressure | 10 bar |
| Exit temperature | 950°C |
| Steam/fuel mass-ratio | 1 (natural gas) 0.2 (biogas) ^a |
| Methanol synthesis | |
| Pressure | 144 bar |
| Temperature | 235°C |
| Recirculation percentage of unconverted syngas | 95% |
| H ₂ content in purged syngas | 30 mol% |
| Distillation | |
| pressure | 3.5 bar |
| Compressors | |
| Isentropic efficiency | 90% |
| Mechanical efficiency | 98% |
| Electrical efficiency | 95% |
| Heat exchangers | |
| Minimum ΔT at pinch point ^b | 10°C |
| or Maximum effectiveness ^b | 90% |

^a Except for one case (plant E+B+CCS, see Table 2).^b The minimum temperature difference at pinch point is used for all heat exchangers unless it violates the maximum heat exchanger effectiveness.

Table 2

Mass flow, pressure and temperature for all nodes shown on Fig. 1 for all six plant configurations.

| | Plant E+B+NG | | | Plant E+B | | | Plant E+B+CCS | | | Plant E+NG+CO ₂ | | |
|-----------------|--------------|------------|-----------|-------------|------------|-----------|----------------|------------|-----------|----------------------------|------------|-----------|
| | M (kg/s) | P (bar) | T (°C) | M (kg/s) | P (bar) | T (°C) | M (kg/s) | P (bar) | T (°C) | M (kg/s) | P (bar) | T (°C) |
| 1 | 3.4 | 1 | 15 | 5.8 | 1 | 15 | 2.4 | 1 | 15 | 4.5 | 1 | 15 |
| 2 | 0.4 | 1 | 90 | 0.6 | 1 | 90 | 0.3 | 1 | 90 | 0.5 | 1 | 90 |
| 3 | 0 | - | - | 3.4 | 1 | 90 | 0 | - | - | 0 | - | - |
| 4 | 1.2 | 1 | 790 | 1.7 | 1 | 790 | 2.1 | 1 | 790 | 0 | - | - |
| 5 | 1.8 | 10 | 850 | 0 | - | - | 0 | - | - | 4.0 | 1 | 850 |
| 6 | 12.6 | 1 | 15 | 17.8 | 1 | 15 | 22.2 | 1 | 15 | 0 | - | - |
| 7 | 6.6 | 1 | 120 | 9.4 | 1 | 120 | 11.7 | 1 | 120 | 0 | - | - |
| 8 | 1.3 | 1 | 730 | 1.9 | 1 | 730 | 5 ^c | 1 | 730 | 0 | - | - |
| 9 | 0.3 | 1 | 800 | 0.5 | 1 | 800 | 0.6 | 1 | 800 | 0 | - | - |
| 10 | 8.9 | 1 | 800 | 12.5 | 1 | 800 | 18.2 | 1 | 800 | 0 | - | - |
| 11 | 8.9 | 1 | 60 | 12.5 | 1 | 60 | 18.2 | 1 | 60 | 0 | - | - |
| 12 | ~0 | 1 | - | ~0 | 1 | - | ~0 | 1 | - | 0 | - | - |
| 13 | 0 | 1 | - | 0 | - | - | 4.6 | - | - | 0 | - | - |
| 14 | 8.9 | 1 | 60 | 12.5 | 1 | 60 | 13.6 | 1 | 60 | 0 | - | - |
| 15 | 1.9 | 10 | 667 | 0 | - | - | 0 | - | - | 4.3 | 10 | 667 |
| 16 | 1.9 | 10 | 850 | 0 | - | - | 0 | - | - | 4.3 | 10 | 850 |
| 17 | 5.6 | 10 | 950 | 0 | - | - | 0 | - | - | 12.7 | 10 | 950 |
| 18 | 0.3 | 10 | 108 | 0 | - | - | 0 | - | - | 0.8 | 10 | 108 |
| 19 | 5.2 | 10 | 154 | 0 | - | - | 0 | - | - | 11.8 | 10 | 154 |
| 20 | 0 | - | - | 0 | - | - | 0 | - | - | 6.7 | 1 | 15 |
| 21 | 14.4 | 20 | 130 | 13.2 | 19 | 130 | 13.9 | 20 | 130 | 19.0 | 20 | 130 |
| 22 | 0.6 | 62 | 136 | 0 | - | - | 1.6 | - | - | 1.0 | 59 | 141 |
| 23 | 13.9 | 144 | 253 | 13.2 | 144 | 251 | 12.4 | 144 | 248 | 18.0 | 144 | 260 |
| 24 | 59.3 | 139 | 235 | 51.9 | 139 | 235 | 42.2 | 139 | 235 | 96.3 | 139 | 235 |
| 25 ^a | 51.6 | 139 | 60 | 44.0 | 139 | 60 | 33.6 | 139 | 60 | 88.4 | 139 | 60 |
| 26 ^b | 45.4 | 144 | 225 | 38.7 | 144 | 225 | 29.8 | 144 | 225 | 78.3 | 144 | 225 |
| 27 | 2.4 | 139 | 60 | 2.0 | 139 | 60 | 1.6 | 139 | 60 | 4.1 | 139 | 60 |
| 28 ^a | 11.5 | 3.5 | 101 | 11.1 | 3.5 | 101 | 10.8 | 3.5 | 101 | 13.9 | 3.5 | 104 |
| 29 | 1.2 | 3.5 | 64 | 0.8 | 3.5 | 64 | 0.5 | 3.5 | 64 | 3.6 | 3.5 | 64 |
| 30 | 10.3 | 3.5 | 100 | 10.3 | 3.5 | 100 | 10.3 | 3.5 | 100 | 10.3 | 3.5 | 100 |

Table 2 (continued)

| | Plant E+BG | | | Plant E+CO ₂ | | |
|----|-------------|------------|-----------|-------------------------|------------|-----------|
| | M (kg/s) | P (bar) | T (°C) | M (kg/s) | P (bar) | T (°C) |
| 1 | 4.6 | 1 | 15 | 18.6 | 1 | 15 |
| 2 | 0.5 | 1 | 90 | 2.1 | 1 | 90 |
| 3 | 0.1 | 1 | 90 | 16.5 | 1 | 90 |
| 4 | 0 | - | - | 0 | - | - |
| 5 | 3.9 | 1 | 850 | 0 | - | - |
| 6 | 0 | - | - | 0 | - | - |
| 7 | 0 | - | - | 0 | - | - |
| 8 | 0 | - | - | 0 | - | - |
| 9 | 0 | - | - | 0 | - | - |
| 10 | 0 | - | - | 0 | - | - |
| 11 | 0 | - | - | 0 | - | - |
| 12 | 0 | - | - | 0 | - | - |
| 13 | 0 | - | - | 0 | - | - |
| 14 | 0 | - | - | 0 | - | - |
| 15 | 10.1 | 10 | 891 | 0 | - | - |

| | | | | | | |
|-----------------|------|-----|-----|-------|-----|-----|
| 16 | 2.0 | 10 | 850 | 0 | - | - |
| 17 | 16.1 | 10 | 950 | 0 | - | - |
| 18 | 0.7 | 10 | 107 | 0 | - | - |
| 19 | 15.4 | 10 | 151 | 0 | - | - |
| 20 | 0 | - | - | 19.6 | 1 | 15 |
| 21 | 15.9 | 21 | 130 | 21.7 | 15 | 130 |
| 22 | 1.1 | 63 | 141 | 0 | - | - |
| 23 | 14.8 | 144 | 255 | 21.7 | 144 | 261 |
| 24 | 68.5 | 139 | 235 | 124.5 | 139 | 235 |
| 25 ^a | 61 | 139 | 60 | 114.8 | 139 | 60 |
| 26 ^b | 53.7 | 144 | 225 | 102.8 | 144 | 225 |
| 27 | 2.8 | 139 | 60 | 5.4 | 139 | 60 |
| 28 ^a | 12.0 | 3.5 | 102 | 16.3 | 3.5 | 107 |
| 29 | 1.7 | 3.5 | 64 | 6.0 | 3.5 | 64 |
| 30 | 10.3 | 3.5 | 100 | 10.3 | 3.5 | 100 |

Table 3

Gas composition for specific nodes in Fig. 1 for all six plant configurations (in mole%).

| | Plant E+B+NG | | | | | Plant E+B | | | | Plant E+B+CCS | | | |
|--------------------|--------------|------|------|------|------|-----------|------|------|------|---------------|------|------|------|
| | 10 | 17 | 23 | 24 | 27 | 10 | 23 | 24 | 27 | 10 | 23 | 24 | 27 |
| H ₂ | 46.0 | 57.7 | 60.6 | 24.4 | 30.0 | 46.0 | 61.9 | 23.9 | 30.0 | 45.6 | 60.7 | 22.8 | 30.0 |
| CO | 42.7 | 22.5 | 29.2 | 3.3 | 4.0 | 42.7 | 30.1 | 3.9 | 4.9 | 32.2 | 34.0 | 5.2 | 6.9 |
| CO ₂ | 5.2 | 5.1 | 4.5 | 46.4 | 57.1 | 5.2 | 3.7 | 44.1 | 55.4 | 9.4 | 0.0 | 40.3 | 53.1 |
| H ₂ O | 5.2 | 14.2 | 5.1 | 2.9 | 0.0 | 5.2 | 3.7 | 2.3 | 0.0 | 12.3 | 4.8 | 1.5 | 0.0 |
| CH ₄ | 0.5 | 0.6 | 0.4 | 4.8 | 5.9 | 0.5 | 0.3 | 4.1 | 5.2 | 0.2 | 0.2 | 2.3 | 3.0 |
| N ₂ | 0.3 | 0 | 0.1 | 1.3 | 1.6 | 0.3 | 0.2 | 2.1 | 2.7 | 0.2 | 0.2 | 3.3 | 4.3 |
| Ar | 0.1 | 0 | 0.1 | 0.6 | 0.8 | 0.1 | 0.1 | 1.0 | 1.3 | 0.1 | 0.1 | 1.6 | 2.1 |
| CH ₃ OH | 0 | 0 | 0 | 16.3 | 0.6 | 0 | 0 | 18.6 | 0.6 | 0 | 0 | 22.9 | 0.6 |
| kmol/s | 0.55 | 0.45 | 1.12 | 2.05 | 0.08 | 0.77 | 1.09 | 1.79 | 0.07 | 1.11 | 1.06 | 1.45 | 0.06 |
| M | 0.9 | 1.9 | 1.7 | - | -0.4 | 0.9 | 1.7 | - | -0.4 | 0.9 | 1.8 | - | -0.4 |

| | Plant E+NG+CO ₂ | | | | Plant E+BG | | | | Plant E+CO ₂ | | |
|--------------------|----------------------------|------|------|------|------------|------|------|------|-------------------------|------|------|
| | 17 | 23 | 24 | 27 | 17 | 23 | 24 | 27 | 23 | 24 | 27 |
| H ₂ | 57.7 | 61.6 | 25.3 | 30.0 | 46.1 | 60.4 | 24.7 | 30.0 | 69.8 | 25.3 | 30.0 |
| CO | 22.5 | 16.5 | 1.9 | 2.3 | 31.9 | 26.6 | 2.8 | 3.4 | 0 | 1.5 | 1.8 |
| CO ₂ | 5.1 | 15.3 | 53.4 | 63.4 | 8.2 | 6.8 | 50.6 | 61.5 | 30.2 | 57.0 | 67.7 |
| H ₂ O | 14.2 | 6.2 | 6.0 | 0.1 | 13.4 | 5.8 | 3.8 | 0.0 | 0 | 8.0 | 0.1 |
| CH ₄ | 0.6 | 0.4 | 3.2 | 3.8 | 0.5 | 0.4 | 3.7 | 4.5 | 0 | 0 | 0 |
| N ₂ | 0 | 0 | 0 | 0 | 0 | 0 | 0 | 0 | 0 | 0 | 0 |
| Ar | 0 | 0 | 0 | 0 | 0 | 0 | 0 | 0 | 0 | 0 | 0 |
| CH ₃ OH | 0 | 0 | 10.3 | 0.5 | 0 | 0 | 14.4 | 0.5 | 0 | 8.2 | 0.4 |
| kmol/s | 1.03 | 1.31 | 3.27 | 0.14 | 1.01 | 1.16 | 2.33 | 0.09 | 1.48 | 4.14 | 0.17 |
| M | 1.9 | 1.5 | - | -0.5 | 0.9 | 1.6 | - | -0.5 | 1.3 | - | -0.5 |

Table 4

Energy and exergy inputs for all six plant configurations.

| | E+B+NG | E+B | E+B+CCS | E+NG+CO ₂ | E+BG | E+CO ₂ |
|---|--------|-----|---------|----------------------|-----------------|-------------------|
| Electricity | | | | | | |
| for electrolyser (MW) | 64 | 111 | 46 | 87 | 88 | 357 |
| for compressors (MW) | 23 | 24 | 25 | 23 | 19 ^b | 33 |
| Total (MW) | 87 | 135 | 71 | 110 | 107 | 390 |
| Biomass | | | | | | |
| Energy (MW _{LHV}) | 121 | 172 | 214 | - | - | - |
| Exergy (MW) ^a | 145 | 205 | 256 | - | - | - |
| Natural gas | | | | | | |
| Energy (MW _{LHV}) | 92 | - | - | 210 | - | - |
| Exergy (MW) ^a | 96 | - | - | 219 | - | - |
| Biogas | | | | | | |
| Energy (MW _{LHV}) | - | - | - | - | 204 | - |
| Exergy (MW) ^a | - | - | - | - | 216 | - |
| Total energy input (MW _{LHV}) | 300 | 307 | 285 | 320 | 311 | 390 |
| Total exergy input (MW) | 328 | 340 | 327 | 329 | 323 | 390 |
| Renewables used, incl. electricity (%) | 69 | 100 | 100 | 34 | 100 | 100 |
| Renewables used, excl. electricity (%) | 40 | 56 | 75 | 0 | 66 | 0 |

^a Calculated by the simulation tool DNA as done in [14].^b The electricity consumption of the compressors is lower because the biogas is assumed to be pressurized to 10 bar outside the plant (like the natural gas). The electricity consumption for compression of biogas from 1 to 10 bar is about 6 MW.

Table 5

Energy and exergy outputs from all six plant configurations.

| | E+B+NG | E+B | E+B+CCS | E+NG+CO ₂ | E+BG | E+CO ₂ |
|--|-----------------|-----------------|------------------|----------------------|------|-------------------|
| Methanol | | | | | | |
| Energy (MW _{LHV}) | 205 | 205 | 205 | 205 | 205 | 205 |
| Exergy (MW) ^a | 231 | 231 | 231 | 231 | 231 | 231 |
| Energy efficiency (%) | 68 ^c | 67 ^c | 72 ^c | 64 | 66 | 53 |
| Exergy efficiency (%) | 70 | 68 | 71 | 70 | 72 | 59 |
| District heating | | | | | | |
| Energy (MW) | 80 | 90 | 80 | 82 | 79 | 129 |
| Exergy (MW) ^b | 11 | 13 | 12 | 12 | 12 | 18 |
| <hr/> | | | | | | |
| Total energy output (MW _{LHV}) | 285 | 295 | 285 | 287 | 284 | 334 |
| Total energy efficiency (%) | 95 ^c | 96 ^c | 100 ^c | 90 | 91 | 86 |
| Total exergy efficiency (%) | 74 | 72 | 74 | 74 | 75 | 64 |
| <hr/> | | | | | | |
| Unconverted syngas | | | | | | |
| Energy (MW _{LHV}) | 11 | 9 | 7 | 15 | 12 | 14 |
| Exergy (MW) | 13 | 11 | 8 | 19 | 14 | 18 |

^a Calculated by the simulation tool DNA as done in [14].^b Calculated by using the exergy difference between a stream at 90°C and a stream at 50°C (both at 1 bar). Reference is at 20°C and 1 bar.^c The higher energy efficiencies seen for the plants using gasification are because the biomass input energy (LHV) used in the calculation is for the wet biomass entering the dryer. If instead the biomass input energy (LHV) was calculated based on the dried biomass entering the gasifier, the efficiencies (both methanol efficiencies and total efficiencies) would have been at the same level as plants E+NG+CO₂ and E+BG.

Table 6

Investment estimates for the different plant areas.

| Plant area | Reference size | Cost (M€) | Specific cost | Source |
|--------------------------------------|---------------------------|-----------|--------------------------------------|------------|
| Electrolysis | 1 MWe | 0.2 | 0.2 M€ / MWe | [16], [26] |
| Underground gas storage ^a | 28,000 MWh-H ₂ | 2.7 | 96 €/MWh-H ₂ | [16], [2] |
| Steam drying | 50 t/h of evap. water | 7.5 | 0.54 M€ / (kg/s) _{evap.} | [27] |
| Gasification incl. cleaning | 30 MW _{th} | 13.6 | 0.45 M€ / MW _{th} | [28] |
| Autothermal reforming ^c | 1882 MW _{th} | 267 | 0.14 M€ / MW _{th} | [29] |
| Methanol synthesis ^c | 17 kmol/s syngas feed | 267 | 16 M€ / (kmol/s) | [29] |
| Distillation ^c | 85 kg/s (feed) | 267 | 3.1 M€ / (kg/s) | [29] |

^a It is assumed that the same cost can be used for oxygen storage. The capacity for one cavern is: 28,000 MWh of hydrogen (840,000 kg of hydrogen). The cost are very dependent on the type of underground gas storage (e.g., if the cavern has to be mined or not).

^c The costs for the three plant areas: autothermal reforming, methanol synthesis and distillation are calculated from a total plant investment for commercial GTL plants given in [29]. It is assumed that each of the three plant areas accounts for 1/3 of the total plant investment. The model for the methanol plant is used to determine the relationship between the methanol production (50,000 barrels/day) and the three parameters stated in the “reference size” column for the three plant areas.

Table 7

Prices for the inputs used in the six plant configurations.

| | Price | Source |
|-----------------|------------|--------|
| Electricity | 11.1 €/GJ | [30] |
| Biomass | 4.3 €/GJ | [16] |
| Natural gas | 4.9 €/GJ | [30] |
| Biogas | 7.3 €/GJ | [16] |
| CO ₂ | 15.0 €/ton | [16] |

Table 8

Fuel prices for a number of relevant fuels for comparison of the production cost of methanol for the six plant configurations.

| Fuel | Price/Cost | |
|---|------------|-----------------------|
| | (€/L) | (€/GJ _{ex}) |
| Methanol | | |
| E+B+NG | 0.20 | 11.8 |
| E+B | 0.25 | 14.0 |
| E+B+CCS | 0.21 | 12.4 |
| E+NG+CO ₂ | 0.23 | 13.2 |
| E+BG | 0.25 | 14.6 |
| E+CO ₂ | 0.44 | 25.3 |
| Commercial methanol ^a | 0.13 | 7.1 |
| Gasoline ^b | 0.35 | 10.0 |
| Crude oil ^c | 0.29 | 7.7 |
| Ethanol ^d (2 nd generation) | 0.28 | 12.0 |

^a Price at €159/ton [32]. HHV= 17.7 MJ/l, density = 0.79 kg/l.

^b Danish price excl. VAT and taxes, HHV= 35 MJ/l.

^c Assumed price at \$60/bbl (1 bbl = 159 l), HHV= 37,8 MJ/l.

^d Production cost of 2nd generation ethanol = \$1.36/gal [33]. HHV= 23.4 MJ/l

Table 9

Advantages and disadvantages of the six plant configurations.

| | E+B+NG | E+B | E+B+CCS |
|----------------|--|--|---|
| Advantages: | <ul style="list-style-type: none"> No excess oxygen from electrolyser Low cost | <ul style="list-style-type: none"> Total utilization of the carbon in the biomass | <ul style="list-style-type: none"> No excess oxygen from electrolyser Low cost Possibly a negative CO₂-emission if captured CO₂ is stored. |
| Disadvantages: | <ul style="list-style-type: none"> Fossil fuel input | | |
| | E+NG+CO ₂ | E+BG | E+CO ₂ |
| Advantages: | <ul style="list-style-type: none"> No excess oxygen from electrolyser | <ul style="list-style-type: none"> No excess oxygen from electrolyser | <ul style="list-style-type: none"> High regulating ability for the electricity grid |
| Disadvantages: | <ul style="list-style-type: none"> Fossil fuel input | | <ul style="list-style-type: none"> High cost Relatively low methanol efficiencies |