



HAL
open science

Mathematical Analysis of parallel convective exchangers

Julien Bouyssier, Charles Pierre, Franck Plouraboué

► **To cite this version:**

Julien Bouyssier, Charles Pierre, Franck Plouraboué. Mathematical Analysis of parallel convective exchangers. 2012. hal-00667657v1

HAL Id: hal-00667657

<https://hal.science/hal-00667657v1>

Preprint submitted on 8 Feb 2012 (v1), last revised 26 Feb 2013 (v2)

HAL is a multi-disciplinary open access archive for the deposit and dissemination of scientific research documents, whether they are published or not. The documents may come from teaching and research institutions in France or abroad, or from public or private research centers.

L'archive ouverte pluridisciplinaire **HAL**, est destinée au dépôt et à la diffusion de documents scientifiques de niveau recherche, publiés ou non, émanant des établissements d'enseignement et de recherche français ou étrangers, des laboratoires publics ou privés.

MATHEMATICAL ANALYSIS OF PARALLEL CONVECTIVE EXCHANGERS

JULIEN BOUYSSIER, CHARLES PIERRE, AND FRANCK. PLOURABOUÉ

ABSTRACT. We propose a mathematical analysis of parallel convective exchangers for any general but longitudinally invariant domains. We analyse general Dirichlet or Neumann prescribed boundary conditions at the outer solid domain. Our study provides general mathematical expressions for the solution of convection/diffusion problems. Explicit form of generalised solutions along longitudinal coordinate are found from convoluting elementary base exponential Graetz mode with the applied sources at the boundary. In the case of adiabatic zero flux counter-current configuration we find a new longitudinally linearly varying solution associated with the zeroth eigenmode which can be considered as the fully developed asymptotic behaviour for heat-exchangers. We also provide general expression for the infinite asymptotic behaviour of the solutions which depends on simple parameters such as total convective flux, outer domain perimeter and the applied boundary conditions. Practical considerations associated with the numerical precision of the truncated mode decomposition is also analysed in various configurations for illustrating the versatility of the proposed formalism. Numerical quantities of interest are carefully investigated, such as fluid/solid internal and external fluxes.

1. INTRODUCTION

1.1. Applicative context. Heat exchangers are omnipresent in many industrial processes where heat is to be recovered or, on the contrary, disposed, from one fluid onto another. Applications might be associated with heating or cooling systems, but can also involve other processes such as pasteurisation, crystallisation, distillation, concentration or separation of some substances [12, 5, 6]. Similarly mass exchangers are also important either in natural biological organs such as kidney and/or biotechnological applications such as devices for continuous extra corporeal blood purification associated with hemo-dialysis, hemo-filtration or extracorporeal oxygenation.

For both mass or heat exchangers, the exchange takes place from coupled convection/diffusion processes without any direct contact between the input and the output fluids, for obvious contamination purposes. Many industrial examples of such devices are possible to find such as radiators, condensers, evaporators, air pre-heaters, cooling towers as well as extra corporeal membrane oxygenation and blood micro-filters [1]. Also found in exchangers as a generic, although not systematic, common feature, is parallel flow design configuration. This is the class of exchangers that we are going to consider in this paper, with the hypothesis that there is no longitudinal variation of the fluid-velocity along the exchanger axis.

Date: February, 2012.

Key words and phrases. Heat and mass transfer, convection diffusion, variational formulation, Graetz mode decomposition, mixed formulation, convective exchangers.

From the complexity of most of the chosen designs, as well as the operating conditions, various specific boundary conditions are considered to be applied at the fluid surface inside such devices. This is for example found in the heat pipes literature with axi-symmetric configurations [15, 9, 16, 7, 17, 18], for which a number of different boundary conditions can possibly be considered at the outer fluid surface. One finds, for example, uniform profile (uniform Dirichlet) in transverse and longitudinal directions, uniform profile along longitudinal direction only, radiative boundary conditions, uniform flux (uniform Neumann), or exponentially varying profile along longitudinal direction. It is interesting to mention that the latter permits to take into account a part of the convection/diffusion coupling between the fluid and the solid, as described by fully developed Graetz modes which are indeed exponentially decaying solutions [3, 8].

Hence, each operating conditions thus necessitates a case-specific theoretical treatment without any generally theoretical framework which could describe the complete coupling between convection arising inside the fluid coupled with the diffusion inside the solid.

The purpose of this contribution is to provide such theoretical framework for any general set of prescribed temperature profile or applied flux around the exterior solid boundary of the exchanger. This work is an extension of two previous contributions which have permitted to generalise standard Graetz eigenmodes decomposition to any, possibly complicated, configuration in the transverse direction, whilst longitudinally invariant. One considerable advantage of the developed formalism is to provide a two-dimensional formulation of a fully tri-dimensional problem. In [10] longitudinally infinite exchangers are considered with homogeneous Dirichlet boundary conditions. In a second contribution, the extension of two-dimensional formulation to finite configurations [2] has also been considered, again for the homogeneous Dirichlet boundary condition at the outer solid surface.

In this paper, we generalise previous approaches for the very general case of any applied Dirichlet or Neumann boundary condition. Of particular interest is the Neumann case for which, two distinct class of problems emerges from its mathematical properties: the case where the total flux Q of the convective fluid is non-zero (such as encountered in convective heat pipes for example) and the one for which the total flux is exactly zero (such as encountered in counter-current exchangers).

1.2. Physical problem and state of the art. This paper considers stationary convection diffusion in a *tube*, i.e. on a domain $\Omega \times I$ with $\Omega \subset \mathbb{R}^2$ a smooth bounded domain and $I \subset \mathbb{R}$ an interval (possibly unbounded). A point $M \in \Omega \times I$ has for coordinates $M = (x, z)$ with $x = (x_1, x_2) \in \Omega$ and $z \in I$. The tube section Ω is divided into a fluid and a solid part of arbitrary geometries.

Inside the tube a moving fluid convects a passive tracer, whilst it diffuses inside the immobile solid part. Two physical assumptions are made. Firstly the fluid velocity \mathbf{v} in the tube is independent of z and directed along the z -direction: $\mathbf{v}(x, z) = v(x)\mathbf{e}_z$. Moreover we adopt the natural convention that $v = 0$ in the solid part of the domain Ω . Secondly the thermal conductivity k is assumed to be isotropic and independent of z : $k = k(x) \in \mathbb{R}$ (anisotropic conductivity however could be considered with the condition that \mathbf{e}_z is one principal direction of the conductivity tensor).

In this setting, the stationary convection-diffusion equation for the temperature T on $\Omega \times I$ reads:

$$(1) \quad \operatorname{div}(k\nabla T) + k\partial_z^2 T = v\partial_z T,$$

where $\operatorname{div} = \operatorname{div}_x$ and $\nabla = \nabla_x$.

The velocity v and the conductivity k satisfy mandatorily the two following properties:

$$(2) \quad v \in L^\infty(\Omega), \quad k \in L^\infty(\Omega) \text{ and } 0 < k_m \leq k(x) \leq k_M, \quad x \in \Omega,$$

no additional regularity assumptions on v and k are needed.

Problem (1) has been reformulated in [10], as briefly stated below. On the Hilbert space

$$(3) \quad \mathcal{H} = L^2(\Omega) \times [L^2(\Omega)]^2$$

we consider the unbounded operator \bar{A}

$$(4) \quad \begin{aligned} \bar{A}: D(\bar{A}) \subset \mathcal{H} &\mapsto \mathcal{H}, \quad D(\bar{A}) = H^1(\Omega) \times H_{\operatorname{div}}(\Omega) \\ \forall (s, \mathbf{q}) \in D(\bar{A}), \quad \bar{A}(s, \mathbf{q}) &= (k^{-1}vs - k^{-1}\operatorname{div} \mathbf{q}, k\nabla s). \end{aligned}$$

In matricial notation, the operator \bar{A} displays the form: $\bar{A} = \begin{bmatrix} k^{-1}v & -k^{-1}\operatorname{div} \\ k\nabla & 0 \end{bmatrix}$

Lemma 1.1. *Let $z \in I \mapsto \psi(z) = (T(z), \mathbf{q}(z)) \in \mathcal{H}$ be a differentiable function so that*

$$\forall z \in I, \quad \psi(z) \in D(\bar{A}) \quad \text{and} \quad \frac{d}{dz}\psi(z) = \bar{A}\psi(z),$$

then T is a solution of (1) and $k\nabla T = \partial_z \mathbf{q}$.

Here $z \mapsto T(z)$ is once differentiable in L^2 -norm, so $\partial_z^2 T$ only has a weak (distribution) sense and T is a solution to (1) in the same weak sense.

A strong solution to (1) is recovered if additionally $z \mapsto \mathbf{q}(z)$ is differentiable in $H_{\operatorname{div}}(\Omega)$.

Lemma 1.1 is the starting point in [10, 2] to derive solutions to (1) using the spectral properties of \bar{A} .

In all the sequel Q will denote the total flow flux across Ω :

$$Q = \int_{\Omega} v(x) dx.$$

The case where no net flux arises, i.e. $Q = 0$ is singular for the Neumann case. This case is singular because of the existence of a non trivial element in the kernel of \bar{A} denoted Ψ_0 :

$$(5) \quad \Psi_0 = (1, k\nabla u_0), \quad \operatorname{div}(k\nabla u_0) = v \quad \text{and} \quad k\nabla u_0 \cdot \mathbf{n} = 0 \quad \text{on} \quad \partial\Omega.$$

When $Q = 0$, $u_0 \in H^1(\Omega)$ is well defined (up to a constant) since the compatibility condition $\int_{\Omega} \operatorname{div}(k\nabla u_0) dx = \int_{\partial\Omega} k\nabla u_0 \cdot \mathbf{n} dl = 0 = \int_{\Omega} v dx$. This induces the existence of a special solution T_0 satisfying zero flux condition on $\partial\Omega$,

$$T_0(x, z) = C_1(u_0(x) + z) + C_2,$$

with $C_1, C_2 \in \mathbb{R}$.

1.3. Summary of the paper. This paper is organised in two main parts. In the first part, we present theoretical results and derive analytical solutions to problem (1). The second part provides numerical illustration of the obtained results of the first part whilst the efficiency of the analytical solutions here derived to describe heat exchanges in tubes.

In the first theoretical part we start in section 2 with a spectral analysis of the operator \bar{A} in (4) either considering a Dirichlet or Neumann type boundary condition on $\partial\Omega$. We provide an extension of the results in [10] dedicated to the Dirichlet case. This extension in particular shows that in the Neumann case the physics of the problem depends on the value of the total flux $Q = \int_{\Omega} v dx$. The case $Q = 0$ is quite singular and moreover of great interest in our applicative context: it corresponds to counter-current configuration heat exchanger devices. In all cases our main result in theorem 2.3 states that \bar{A} is diagonal over a (complete) orthogonal basis. The spectrum moreover is made of a double infinite sequence of eigenvalues going both to $+\infty$ and $-\infty$, each sequence corresponding either to the upstream ($z < 0$) or downstream ($z > 0$) region description.

Using these results we derive the solutions to problem (1) for non-homogeneous boundary conditions of Dirichlet and Neumann type. These solutions are studied both for an infinite ($\Omega \times \mathbb{R}$) or semi infinite ($\Omega \times \mathbb{R}^+$) domains in sections 3 and 4 respectively. These solutions are obtained as separate variable series: the variation in the transverse (i.e. Ω) direction is given by the operator \bar{A} eigenfunctions and the longitudinal variation is explicitly given by a simple integral transformation involving both the boundary data (treated as a source term) and the eigenvalues.

Numerical results are given in the last section 5. The analytical solutions in the two previous sections can be approximated by truncating their series expansion and by approximating the eigenvalues and eigenfunctions. This approximation is performed with two-dimensional finite element setting as presented in section 5.1. A first axy-symmetric test case is presented in section 5.2 whose purpose is to validate the method. Finally the method is developed to describe the fluid/solid heat exchange for two more complex configurations: a periodic set of parallel pipes and a counter current heat exchanger.

2. SPECTRAL ANALYSIS

We consider the Hilbert space \mathcal{H} in (3) and the operator \bar{A} in (4). The Hilbert space \mathcal{H} is equipped with the scalar product: $\forall \Psi_i = (f_i, \mathbf{p}_i) \in \mathcal{H}, i = 1, 2$,

$$(\Psi_1 | \Psi_2)_{\mathcal{H}} = \int_{\Omega} f_1 f_2 k(x) dx + \int_{\Omega} \mathbf{p}_1 \cdot \mathbf{p}_2 k^{-1}(x) dx,$$

that is equivalent with the canonical scalar product on \mathcal{H} (i.e. taking $k=1$) thanks to property (2) on k .

With this definition the operator \bar{A} satisfies: $\forall \Psi_i = (s_i, \mathbf{q}_i) \in D(\bar{A}), i = 1, 2$,

$$(6) \quad (\bar{A}\Psi_1 | \Psi_2)_{\mathcal{H}} = (\Psi_1 | \bar{A}\Psi_2)_{\mathcal{H}} + \int_{\partial\Omega} s_1 \mathbf{q}_2 \cdot \mathbf{n} dl - \int_{\partial\Omega} s_2 \mathbf{q}_1 \cdot \mathbf{n} dl,$$

with \mathbf{n} the unit normal on $\partial\Omega$ pointing outwards Ω .

Definition 2.1. We respectively introduce two restrictions A_D and A_N of the operator \bar{A} relatively to a homogeneous Dirichlet (D) or homogeneous Neumann (N)

boundary condition with domains $D(A_D)$ and $D(A_N)$:

$$D(A_D) = H_0^1(\Omega) \times H_{\text{div}}(\Omega), \quad D(A_N) = H^1(\Omega) \times H_{\text{div}}^0(\Omega),$$

with

$$H_{\text{div}}^0(\Omega) = \{\mathbf{q} \in H_{\text{div}}(\Omega), \quad \mathbf{q} \cdot \mathbf{n} = 0 \text{ on } \partial\Omega\}.$$

The operators A_D and A_N clearly have dense domains in \mathcal{H} . Using the property (6) they also are symmetric:

$$\forall \Psi_1, \Psi_2 \in D(A) : (A\Psi_1 | \Psi_2)_{\mathcal{H}} = (\Psi_1 | A\Psi_2)_{\mathcal{H}},$$

either with $A = A_D$ or $A = A_N$.

Theorem 2.1. *The two operators A_D and A_N in definition 2.1 are self adjoint.*

With theorem 2.1 We have:

$$\mathcal{H} = \text{Ker}(A_D) \oplus \text{Ran}(A_D) = \text{Ker}(A_N) \oplus \text{Ran}(A_N),$$

we now characterise these spaces.

Corollary 2.2. *In the Dirichlet case,*

$$\begin{aligned} \text{Ker}(A_D) &= \{(0, \mathbf{q}), \quad \mathbf{q} \in H_{\text{div}}(\Omega) \text{ and } \text{div } \mathbf{q} = 0\}, \\ \text{Ran}(A_D) &= \{(f, k\nabla s), \quad f \in L^2(\Omega), \quad s \in H_0^1(\Omega)\}. \end{aligned}$$

In the Neumann case let us consider,

$$\begin{aligned} K_N &= \{(0, \mathbf{q}), \quad \mathbf{q} \in H_{\text{div}}^0(\Omega) \text{ and } \text{div } \mathbf{q} = 0\}, \\ R_N &= \{(f, k\nabla s), \quad f \in L^2(\Omega), \quad s \in H^1(\Omega)\}. \end{aligned}$$

if $Q \neq 0$: $\text{Ker}(A_N) = K_N$ and $\text{Ran}(A_N) = R_N$,

if $Q = 0$: let us consider Ψ_0 defined in (5),

$$\text{Ker}(A_N) = K_N \oplus \text{Span}(\Psi_0), \quad R_N = \text{Ran}(A_N) \oplus \text{Span}(\Psi_0).$$

We then always have $\mathcal{H} = K_N \oplus R_N$.

In addition to these *symmetry* properties, the spectrum of the operators A_D and A_N can be fully characterised. Let us denote

$$\text{Sp}^*(A) := \text{Sp}(A) - \{0\},$$

the spectrum of the operator A without the singleton $\{0\}$. Either for $A = A_D$ or $A = A_N$, $\text{Sp}^*(A)$ displays the same double sequence structure $\text{Sp}^*(A) = (\lambda_n)_{n \in \mathbb{Z}^*}$ with:

$$(7) \quad -\infty \xleftarrow{n \rightarrow +\infty} \lambda_n \leq \dots \leq \lambda_1 < 0 < \lambda_{-1} \leq \dots \leq \lambda_{-n} \xrightarrow{n \rightarrow +\infty} +\infty.$$

Negative values of $\lambda \in \text{Sp}^*(A)$ will be referred to as downstream modes whereas positive values will be referred to as upstream modes.

Theorem 2.3. *The two operators $A_D^{-1} : \text{Ran}(A_D) \mapsto \mathcal{H}$ and $A_N^{-1} : \text{Ran}(A_N) \mapsto \mathcal{H}$ are compact.*

We have $\text{Sp}^(A_D) = (\lambda_n^D)_{n \in \mathbb{Z}^*}$ and $\text{Sp}^*(A_N) = (\lambda_n^N)_{n \in \mathbb{Z}^*}$, these two sequences satisfy (7).*

Elements of $\text{Sp}^(A_D)$ and of $\text{Sp}^*(A_N)$ are eigenvalues of finite order, the associated eigenvectors $(\Psi_n^D)_{n \in \mathbb{Z}^*}$ and $(\Psi_n^N)_{n \in \mathbb{Z}^*}$ form a Hilbert basis (with orthogonal vectors of norm 1) of $\text{Ran}(A_D)$ and $\text{Ran}(A_N)$ respectively.*

We will denote $\Psi_n^D = (T_n^D, \mathbf{q}_n^D)$ and $\Psi_n^N = (T_n^N, \mathbf{q}_n^N)$, with $\mathbf{q}_n^{D,N} = k\nabla T_n^{D,N} / \lambda_n^{D,N}$.

An important consequence is that, A denoting either A_D or A_N ,

$$(8) \quad \psi \in \text{Ran}(A) \quad \text{iff} \quad \sum_{n \in \mathbb{Z}^*} |(\psi | \Psi_n)_{\mathcal{H}}|^2 < +\infty,$$

$$(9) \quad \psi \in D(A) \cap \text{Ran}(A) \quad \text{iff} \quad \|\psi\|_{D(A)}^2 := \sum_{n \in \mathbb{Z}^*} |\lambda_n (\psi | \Psi_n)_{\mathcal{H}}|^2 < +\infty,$$

and $\|\psi\|_{D(A)}$ is a norm equivalent to the $H^1(\Omega) \times H_{\text{div}}(\Omega)$ norm.

Proof of theorem 2.1. The Dirichlet case has already been proved in [10]. The proof in the Neumann case follows the same arguments and is detailed here.

We have $A_N = A_0 + V$ with $A_0 : (s, \mathbf{q}) \in D(A_N) \mapsto (-k^{-1} \text{div } \mathbf{q}, k \nabla s)$ and $V : (f, \mathbf{p}) \mapsto (k^{-1} v f, 0)$. Both A_N and A_0 are symmetric with domain $D(A_N)$ that is dense in \mathcal{H} and V is bounded on \mathcal{H} . Using the Kato-Rellich theorem (see e.g. [14] p. 163), the self-adjointness of A_0 implies the self-adjointness of A_N . To prove the self-adjointness of A_0 , let us show that $A_0 + i$ has range \mathcal{H} (see e.g. [13]).

Let $(f, \mathbf{p}) \in \mathcal{H}$, using the Lax Milgram theorem there exists a unique $\mathbf{q} \in H_{\text{div}}^0(\Omega)$ so that for all $\chi \in H_{\text{div}}^0(\Omega)$:

$$(10) \quad \int_{\Omega} (\mathbf{q} \cdot \chi + \text{div } \mathbf{q} \text{ div } \chi) k^{-1} dx = \int_{\Omega} (-i \mathbf{p} \cdot \chi k^{-1} - f \text{ div } \chi) dx.$$

More precisely the bilinear form on the left is clearly coercive on $H_{\text{div}}^0(\Omega)$ thanks to property (2) and the linear form on the right is continuous on $H_{\text{div}}^0(\Omega)$. We now consider the function s so that $is - k^{-1} \text{div } \mathbf{q} = f$, let us prove that $\Psi = (s, \mathbf{q}) \in D(A_N)$. With $\text{div } \mathbf{q} = k(is - f)$ we get in (10):

$$\forall \chi \in H_{\text{div}}^0(\Omega), \quad - \int_{\Omega} s \text{ div } \chi dx = \int_{\Omega} k^{-1} (\mathbf{p} - i \mathbf{q}) \cdot \chi dx,$$

so that in distribution sense $\nabla s = k^{-1} (\mathbf{p} - i \mathbf{q}) \in [L^2(\Omega)]^2$. It follows that $s \in H^1(\Omega)$ and $\Psi \in D(A_N)$. In addition we have $is - k^{-1} \text{div } \mathbf{q} = f$ and $k \nabla s + i \mathbf{q} = \mathbf{p}$ which means $(f, \mathbf{p}) = A_0 \Psi + i \Psi$ and so $\text{Ran}(A_0 + i) = \mathcal{H}$. \square

Proof of corollary 2.2. We prove the Neumann case only. If $\Psi = (s, \mathbf{q}) \in D(A_N)$ satisfies $A_N \Psi = 0$ then $k \nabla s = 0$ and therefore s is a constant. Now we have $sv - \text{div}(q) = 0$ with $s \in \mathbb{R}$.

In case $Q \neq 0$, by integrating $sv - \text{div}(q) = 0$ over Ω and using the divergence formula we get $s \int_{\Omega} v dx = sQ = 0$ and so $s = 0$. It follows that $\text{div } \mathbf{q} = 0$, as a result $\text{Ker}(A_N) = K_N$ in this case.

In case $Q = 0$, s can be a non zero constant and in this case $\Psi = s \Psi_0 + (0, \mathbf{q})$ with Ψ_0 defined in (5) and with $\text{div } \mathbf{q} = \mathbf{0}$. Thus $\text{Ker}(A_N) = K_N \oplus \text{Span}(\Psi_0)$ in this case.

It remains to prove that $K_N \oplus R_N = \mathcal{H}$. In case $Q \neq 0$ this is simply consequence of the self adjointness of A_N . But since by definition neither K_N nor R_N depends on the velocity v this is true independently on Q and thus also holds in the case $Q = 0$. \square

Proof of theorem 2.3. The compactness has already been proved in the Dirichlet case with additional regularity assumptions on k in [10]. We here give the proof for $k \in L^\infty(\Omega)$ and for the Neumann case only, the proof in the Dirichlet case is similar and a bit simpler.

We consider $(f_n, \mathbf{p}_n) \in \text{Ran}(A_N)$ a bounded sequence in L^2 -norm. We consider $(s_n, \mathbf{q}_n) \in D(A_N) \cap \text{Ran}(A_N)$ so that $\bar{A}(s_n, \mathbf{q}_n) = (f_n, \mathbf{p}_n)$, one has to prove that the sequence (s_n, \mathbf{q}_n) is compact in L^2 -norm.

Let us first prove that (s_n) is compact in $L^2(\Omega)$

We firstly have that $k\nabla s_n = \mathbf{p}_n$ and thus $\|\nabla s_n\|_{L^2}$ is bounded. The Poincaré Wirtinger inequality then ensures that $\|s_n - c_n\|_{L^2}$ is bounded with $c_n = \int_{\Omega} s_n dx$ the mean value of s_n . If we prove that (c_n) is bounded, we obtain that $\|s_n\|_{L^2}$ is also bounded and then that (s_n) is bounded in $H^1(\Omega)$. This proves that s_n is compact in $L^2(\Omega)$ using the Rellich-Kondrachov compactness theorem (compact embedding of $H^1(\Omega)$ into $L^2(\Omega)$ for bounded domains with smooth boundary).

If $Q \neq 0$, we have $vs_n - \text{div}(\mathbf{q}_n) = kf_n$ and integrating over Ω we get that

$$\int_{\Omega} v(s_n - c_n)dx + c_n \int_{\Omega} vdx - \int_{\Omega} \text{div}(\mathbf{q}_n)dx = \int_{\Omega} v(s_n - c_n)dx + c_n Q = \int_{\Omega} kf_n dx,$$

because \mathbf{q}_n satisfies a zero flux condition on $\partial\Omega$. Since f_n and $s_n - c_n$ are bounded in L^2 -norm, we get that c_n is bounded.

If $Q = 0$, with corollary 2.2 we have the additional constraint here that $((s_n, \mathbf{q}_n)|_{\Psi_0})_{\mathcal{H}} = 0 = \int_{\Omega} ks_n dx + \int_{\Omega} \mathbf{q}_n \cdot \nabla u_0 dx$. With $vs_n - \text{div}(\mathbf{q}_n) = kf_n$ we have $\int_{\Omega} \mathbf{q}_n \cdot \nabla u_0 dx = \int_{\Omega} (kf_n - vs_n)u_0 dx$. The orthogonality constraint then gives,

$$\int_{\Omega} s_n(k - vu_0)dx + \int_{\Omega} ku_0 f_n dx = 0,$$

so that,

$$c_n \int_{\Omega} (k - vu_0)dx = \int_{\Omega} (s_n - c_n)(vu_0 - k)dx - \int_{\Omega} ku_0 f_n dx.$$

The right hand side is bounded and moreover (with $\text{div}(k\nabla u_0) = v$) the pre-factor $\int_{\Omega} (k - vu_0)dx = \int_{\Omega} k(1 + \nabla u_0 \cdot \nabla u_0)dx$ is non zero. It follows that (c_n) is bounded.

Let us now prove that \mathbf{q}_n is compact in $[L^2(\Omega)]^2$.

With corollary 2.2 we firstly have that $\mathbf{q}_n = k\nabla u_n$ with $u_n \in H^1(\Omega)$. We can moreover impose that $\int_{\Omega} u_n dx = 0$. We have that $\|k\nabla u_n\|_{L^2}$ is bounded and with the Poincaré-Wirtinger inequality it follows that u_n is bounded in $H^1(\Omega)$ thus compact in $L^2(\Omega)$. We also have that $g_n := \text{div}(k\nabla u_n) = vs_n - kf_n$ is bounded in $L^2(\Omega)$.

Up to one sub-sequence extraction, we then can assume that:

$$\begin{aligned} s_n &\longrightarrow s \text{ strongly in } L^2(\Omega), & u_n &\longrightarrow u \text{ strongly in } L^2(\Omega), \\ \mathbf{q}_n &\longrightarrow \mathbf{q} \text{ weakly in } [L^2(\Omega)]^2, & g_n &\longrightarrow g \text{ weakly in } L^2(\Omega). \end{aligned}$$

We have to prove that indeed $\mathbf{q}_n \longrightarrow \mathbf{q}$ strongly in $[L^2(\Omega)]^2$.

Let us first prove that $u \in H^1(\Omega)$ with $k\nabla u = \mathbf{q}$ and that $\mathbf{q} \in H_{\text{div}}^0(\Omega)$ with $\text{div} \mathbf{q} = g$.

For all test function $\chi \in [C_c^\infty(\Omega)]^2$,

$$\begin{aligned} \int_{\Omega} k^{-1} \mathbf{q} \cdot \chi dx &= \lim_n \int_{\Omega} k^{-1} \mathbf{q}_n \cdot \chi dx = \lim_n \int_{\Omega} \nabla u_n \cdot \chi dx = - \lim_n \int_{\Omega} u_n \text{div} \chi dx \\ &= - \int_{\Omega} u \text{div} \chi dx, \end{aligned}$$

in the distribution sense, this means $\nabla u = k^{-1} \mathbf{q} \in L^2(\Omega)$ i.e. $u \in H^1(\Omega)$ and $k\nabla u = \mathbf{q}$.

Now for all $\varphi \in H^1(\Omega)$, since $\mathbf{q}_n \in H_{\text{div}}^0(\Omega)$, we have

$$\int_{\Omega} \varphi g dx = \lim_n \int_{\Omega} \varphi g_n dx = \lim_n \int_{\Omega} \varphi \operatorname{div} \mathbf{q}_n dx = - \lim_n \int_{\Omega} \nabla \varphi \cdot \mathbf{q}_n dx = - \int_{\Omega} \nabla \varphi \cdot \mathbf{q} dx.$$

This first ensures that $\operatorname{div} \mathbf{q} = g \in L^2(\Omega)$ in the sense of distributions (because $C_c^\infty(\Omega) \subset H^1(\Omega)$) so that $\mathbf{q} \in H_{\text{div}}(\Omega)$. Now that we have $\mathbf{q} \in H_{\text{div}}(\Omega)$, using the Green formula we moreover have for all $\varphi \in H^1(\Omega)$:

$$\int_{\Omega} \varphi g dx = - \int_{\Omega} \nabla \varphi \cdot \mathbf{q} dx = \int_{\Omega} \varphi \operatorname{div} \mathbf{q} dx - \int_{\partial\Omega} \varphi \mathbf{q} \cdot \mathbf{n} dl = \int_{\Omega} \varphi g dx - \int_{\partial\Omega} \varphi \mathbf{q} \cdot \mathbf{n} dl..$$

The boundary integral is always equal to zero and thus $\mathbf{q} \in H_{\text{div}}^0(\Omega)$.

Finally, we now can conclude than $\|\mathbf{q}_n - \mathbf{q}\|_{L^2} \rightarrow 0$:

$$\|\mathbf{q}_n - \mathbf{q}\|_{L^2}^2 = \int_{\Omega} k k^{-1} (\mathbf{q}_n - \mathbf{q}) \cdot (\mathbf{q}_n - \mathbf{q}) dx \leq k_M \int_{\Omega} k^{-1} (k \nabla u_n - k \nabla u) \cdot (\mathbf{q}_n - \mathbf{q}) dx,$$

using inequality (2). With the Green formula it follows that,

$$\begin{aligned} \|\mathbf{q}_n - \mathbf{q}\|_{L^2}^2 &\leq k_M \int_{\Omega} \nabla(u_n - u) \cdot (\mathbf{q}_n - \mathbf{q}) dx = -k_M \int_{\Omega} (u_n - u)(g_n - g) dx \\ &\leq k_M \|u_n - u\|_{L^2}^2 \|g_n - g\|_{L^2}^2, \end{aligned}$$

with the Cauchy-Schwartz inequality. We conclude to $\|\mathbf{q}_n - \mathbf{q}\|_{L^2} \rightarrow 0$ because $\|u_n - u\|_{L^2} \rightarrow 0$ and because $\|g_n - g\|_{L^2}$ is bounded.

We proved that $A_N^{-1} : \operatorname{Ran}(A_N) \rightarrow \operatorname{Ran}(A_N)$ is compact. It is moreover self adjoint by theorem 2.1 and injective by construction. By Hilbert Schmidt theorem there exists an orthogonal Hilbert basis of $\operatorname{Ran}(A_N)$ made of eigenvectors of A_N^{-1} , moreover 0 is the only limit point of the associated sequence of (non-zero) eigenvalues.

This proves the remaining part of theorem 2.3 excepted the particular structure (7) displayed by the eigenvalues. To prove this we have to show that the Rayleigh coefficients $(\psi, \overline{A}\psi)$ are bounded neither above nor below for $\psi \in D(A_N)$ and $\|\psi\|_{\mathcal{H}} = 1$, we already know that they are unbounded. We have with $\psi = (s, \mathbf{q})$,

$$(\psi, \overline{A}\psi) = \int_{\Omega} v s^2 dx + 2 \int_{\Omega} \mathbf{q} \cdot \nabla s dx.$$

The first term on the right is clearly bounded, then the second one is unbounded and moreover changes of sign when performing the transformation $(s, \mathbf{q}) \rightarrow (-s, \mathbf{q})$. This second term then is unbounded above and below. \square

3. SOLUTIONS ON INFINITE DOMAINS

We here consider the case of an infinite tube $\Omega \times \mathbb{R}$ (ie $I = \mathbb{R}$).

Being given a function $f : \mathbb{R} \mapsto \mathbb{R}$, we look for a solution T to (1) on $\Omega \times \mathbb{R}$ for the two following problems.

$$(11) \quad \textit{Dirichlet problem:} \quad T(x, z) = f(z) \quad \text{for } x \in \partial\Omega,$$

$$(12) \quad \textit{Neumann problem:} \quad k \nabla T(x, z) \cdot \mathbf{n} = f(z) \quad \text{for } x \in \partial\Omega.$$

We firstly draw the basic ideas to derive solutions to these two problems. Rigorous statements of the solutions are given in the following sub-sections, they follow the preliminary formal results given below.

With lemma 1.1, we search for a solution $\psi(z) = (T(z), \mathbf{q}(z))$ to $d\psi/dz = \bar{A}\psi$ under the form,

$$\psi(z) = \sum_{n \in \mathbb{Z}^*} d_n(z) \Psi_n^D \quad \text{or} \quad \psi(z) = \sum_{n \in \mathbb{Z}^*} d_n(z) \Psi_n^N,$$

for the Dirichlet or for the Neumann problems respectively.

Formally differentiating the sums we get,

$$\frac{d}{dz} \psi(z) = \sum_{n \in \mathbb{Z}^*} d'_n(z) \Psi_n^D \quad \text{or} \quad \frac{d}{dz} \psi(z) = \sum_{n \in \mathbb{Z}^*} d'_n(z) \Psi_n^N,$$

so that $d'_n = (\bar{A}\psi | \Psi_n^D)_{\mathcal{H}}$ or $d'_n = (\bar{A}\psi | \Psi_n^N)_{\mathcal{H}}$ respectively. Using (6) we obtain,

$$d'_n = \lambda_n^D d_n + \int_{\partial\Omega} T(z) \mathbf{q}_n^D \cdot \mathbf{n} dl \quad \text{or} \quad d'_n = \lambda_n^N d_n - \int_{\partial\Omega} \mathbf{q}(z) \cdot \mathbf{n} T_n^N dl.$$

For the Dirichlet problem $T(z) = f(z)$ on $\partial\Omega$. For the Neumann problem we have $k\nabla T = \partial_z \mathbf{q}$ so that $\mathbf{q}(z) \cdot \mathbf{n} = F(z)$ with F a primitive of f on $\partial\Omega$.

Let us introduce the coefficients α_n given either for the Dirichlet or for the Neumann problems by:

$$(13) \quad \alpha_n^D = -\frac{1}{\lambda_n^D} \int_{\partial\Omega} \mathbf{q}_n^D \cdot \mathbf{n} dl, \quad \alpha_n^N = \frac{1}{\lambda_n^N} \int_{\partial\Omega} T_n^N dl.$$

Finally the functions $d_n(z)$ satisfy either,

$$d'_n = \lambda_n^D d_n - \lambda_n^D \alpha_n^D f(z) \quad \text{or} \quad d'_n = \lambda_n^N d_n - \lambda_n^N \alpha_n^N F(z),$$

for the Dirichlet or for the Neumann problems respectively.

In the sequel the functions $d_n(z)$ are sought under the form,

$$d_n(z) = \alpha_n^D f(z) + \alpha_n^D c_n(z) \quad \text{or} \quad d_n(z) = \alpha_n^N F(z) + \alpha_n^N c_n(z),$$

thus with the functions $c_n(z)$ solutions of,

$$c'_n = \lambda_n^D c_n - f' \quad \text{or} \quad c'_n = \lambda_n^N c_n - f,$$

respectively for the Dirichlet or for the Neumann problems.

3.1. The coefficients α_n .

Lemma 3.1. *The coefficients α_n defined in (13) satisfy:*

$$(14) \quad \sum_{n \in \mathbb{Z}^*} \alpha_n^D \Psi_n^D = \varphi^D, \quad \sum_{n \in \mathbb{Z}^*} \alpha_n^N \Psi_n^N = \varphi^N,$$

with $\varphi^D \in \text{Ran}(A_D) \cap D(\bar{A})$ uniquely determined by,

$$(15) \quad \varphi^D = (1, k\nabla u^D), \quad u^D \in H_0^1(\Omega) \quad \text{and} \quad \bar{A}\varphi^D = 0,$$

and with $\varphi^N \in \text{Ran}(A_N) \cap D(\bar{A})$ uniquely defined by,

$$(16) \quad \varphi^N = (s^N, k\nabla u^N), \quad u^N \in H^1(\Omega), \quad k\nabla u^N \cdot \mathbf{n} = 1 \quad \text{on} \quad \partial\Omega$$

$$\text{and} \quad \bar{A}\varphi^N = \begin{cases} 0 & \text{if } Q \neq 0 \\ a\Psi_0 & \text{if } Q = 0, \quad a \in \mathbb{R} \end{cases},$$

for Ψ_0 defined in (5). In the particular case $Q = 0$, the constraint $\varphi^N \in \text{Ran}(A_N)$ implies that $(\varphi^N | \Psi_0)_{\mathcal{H}} = 0$.

The Bessel inequality (8) ensures that $\sum_{n \in \mathbb{Z}^*} |\alpha_n^D|^2 < +\infty$ and $\sum_{n \in \mathbb{Z}^*} |\alpha_n^N|^2 < +\infty$. Meanwhile, $\varphi^D \notin D(A_D)$ and $\varphi^N \notin D(A_N)$, we also have with relation (9) $\sum_{n \in \mathbb{Z}^*} |\lambda_n^D \alpha_n^D|^2 = +\infty$ and $\sum_{n \in \mathbb{Z}^*} |\lambda_n^N \alpha_n^N|^2 = +\infty$.

Remark 3.1. Let us precise the definition of the particular functions φ^D and φ^N .

- For the Dirichlet case $\varphi^D = (1, k\nabla u^D)$, the function u^D is determined by the equation $\operatorname{div}(k\nabla u^D) = v$ and $u^D = 0$ on the boundary $\partial\Omega$.
- For the Neumann case when $Q \neq 0$, $\varphi^N = (s^N, k\nabla u^N)$ and s^N is a constant, equal to P/Q with P the perimeter of Ω . The second component is defined by $Q \operatorname{div}(k\nabla u^N) = Pv$ and $k\nabla u^N \cdot \mathbf{n} = 1$ on $\partial\Omega$. This equation is well posed as long as $Q \neq 0$ and u^N is defined up to an additive constant. In the sequel we will fix this constant by imposing that:

$$(17) \quad Q \int_{\Omega} v u^N dx = p \int_{\Omega} k dx.$$

- For the Neumann case when $Q = 0$, let us consider the two constants $a, b \in \mathbb{R}$:

$$(18) \quad a \int_{\Omega} (v u_0 - k) dx = P, \quad P = \int_{\partial\Omega} dl$$

$$(19) \quad b \int_{\Omega} (v u_0 - k) dx = a \int_{\Omega} u_0 (2k - v u_0) dx + \int_{\partial\Omega} u_0 dl,$$

with P the perimeter of the domain Ω and u_0 defined in (5). In this case the function $\varphi^N = (s^N, k\nabla u^N)$ satisfies $s^N = a u_0 + b$.

The function u^N satisfies the elliptic equation $v(a u_0 + b) - \operatorname{div}(k\nabla u^N) = ak$ together with the boundary condition $k\nabla u^N \cdot \mathbf{n} = 1$ on $\partial\Omega$.

The justification of the well posedness of a, b and u^N is detailed in the following proof.

Proof. Let $u^D \in H_0^1(\Omega)$ be the unique solution to $\operatorname{div}(k\nabla u^D) = v$. Then $\varphi^D = (1, k\nabla u^D) \in D(\bar{A}) \cap \operatorname{Ran}(A_D)$ and satisfies $\bar{A}\varphi^D = 0$, this proves (15).

Now let $Q \neq 0$ and let $u^N \in H^1(\Omega)$ be a solution to $Q \operatorname{div}(k\nabla u^N) = Pv$ that satisfies $k\nabla u^N \cdot \mathbf{n} = 1$ on $\partial\Omega$ and where $P = \int_{\partial\Omega} dl$ is the perimeter of Ω . For $Q \neq 0$ such a solution is defined up to an additive constant since the compatibility condition $Q \int_{\Omega} \operatorname{div}(k\nabla u^N) dx = Q \int_{\partial\Omega} k\nabla u^N \cdot \mathbf{n} dl = Q \int_{\partial\Omega} dl = P \int_{\Omega} v dx$ is satisfied. We have $\varphi^N = (P/Q, k\nabla u^N) \in D(\bar{A}) \cap \operatorname{Ran}(A_N)$ and satisfies $\bar{A}\varphi^N = 0$, this proves (16) when $Q \neq 0$.

Let now $Q = 0$, we consider the two constants $a, b \in \mathbb{R}$ given in (18) (19). Note that a and b are well defined since $\int_{\Omega} (v u_0 - k) dx = \int_{\Omega} (\operatorname{div}(k\nabla u_0) u_0 - k) dx = - \int_{\Omega} (k\nabla u_0 \cdot \nabla u_0 + k) dx \neq 0$.

Let $u^N \in H^1(\Omega)$ satisfy $k\nabla u^N \cdot \mathbf{n} = 1$ on $\partial\Omega$ together with the equation ,

$$v(a u_0 + b) - \operatorname{div}(k\nabla u^N) = ak.$$

Since $Q = 0$ and $v = \operatorname{div}(k\nabla u_0)$, the compatibility condition for this equation reads independently on b :

$$\int_{\Omega} (a v u_0 + b v - \operatorname{div}(k\nabla u^N)) dx = a \int_{\Omega} v u_0 dx - P = a \int_{\Omega} k dx.$$

Thus for any value of b the solution $u^N \in H^1(\Omega)$ is well defined up to an additive constant. We define $\varphi^N = (a u_0 + b, k\nabla u^N) \in D(\bar{A})$, we have $\varphi^N \in R_N$ with corollary

2.2. We also want $\varphi^N \in \text{Ran}(A_N)$ and for this it suffices to impose $(\varphi^N | \Psi_0)_{\mathcal{H}} = 0$. This sets the value of b to (19):

$$\begin{aligned} (\varphi^N | \Psi_0)_{\mathcal{H}} &= \int_{\Omega} k(au_0 + b)dx + \int_{\Omega} k\nabla u^N \cdot \nabla u_0 dx \\ &= \int_{\Omega} k(au_0 + b)dx - \int_{\Omega} \text{div}(k\nabla u^N)u_0 dx + \int_{\partial\Omega} u_0 dl \\ &= \int_{\Omega} k(au_0 + b)dx + \int_{\Omega} (ka - (au_0 + b)v)u_0 dx + \int_{\partial\Omega} u_0 dl \\ &= b \int_{\Omega} (k - vu_0)dx + a \int_{\Omega} u_0(2k - vu_0)dx + \int_{\partial\Omega} u_0 dl = 0 \end{aligned}$$

Eventually we have:

$$\overline{A}\varphi^N = (k^{-1}(v(au_0 + b) - \text{div}(k\nabla u^N)), ak\nabla u_0) = (a, ak\nabla u_0) = a\Psi_0.$$

This proves (16) when $Q = 0$.

Since $\varphi^D \in \text{Ran}(A_D)$ and $\varphi^N \in \text{Ran}(A_N)$, to prove (14) it suffices to prove that $(\varphi^D | \Psi_n^D)_{\mathcal{H}} = \alpha_n^D$ and $(\varphi^N | \Psi_n^N)_{\mathcal{H}} = \alpha_n^N$. We prove this in the Neumann case only. Using property (6) we get,

$$\lambda_n^N (\varphi^N | \Psi_n^N)_{\mathcal{H}} = (\varphi^N | \overline{A}\Psi_n^N)_{\mathcal{H}} = (\overline{A}\varphi^N | \Psi_n^N)_{\mathcal{H}} + \int_{\partial\Omega} T_n^N k\nabla u^N \cdot \mathbf{n} dl.$$

We always have $(\overline{A}\varphi^N | \Psi_n^N)_{\mathcal{H}} = 0$ since either $\overline{A}\varphi^N = 0$ if $Q \neq 0$ or $\overline{A}\varphi^N = \Psi_0 \in \text{Ran}(A_N)^\perp$ if $Q = 0$. With $k\nabla u^N \cdot \mathbf{n} = 1$ on $\partial\Omega$ we obtain the result: $(\varphi^N | \Psi_n^N)_{\mathcal{H}} = \int_{\partial\Omega} T_n^N dl / \lambda_n^N = \alpha_n^N$. \square

3.2. The Dirichlet problem. We simply denote here $\lambda_n = \lambda_n^D$, $\Psi_n = \Psi_n^D$ and $\alpha_n = \alpha_n^D$. We introduce the functions $c_n(z)$ for $n \in \mathbb{Z}^*$,

$$(20) \quad c_n(z) = \int_z^{+\infty} f'(\xi)e^{\lambda_n(z-\xi)} d\xi \quad \text{if } n < 0, \quad c_n(z) = - \int_{-\infty}^z f'(\xi)e^{\lambda_n(z-\xi)} d\xi \quad \text{if } n > 0.$$

If we assume that f' is bounded, these functions are well defined (because $\lambda_n < 0$ for $n > 0$ and vice versa), they also are bounded, differentiable and verify $c'_n = \lambda_n c_n - f'$.

Proposition 3.2. *We assume that $f \in C^1(\mathbb{R})$ with f' bounded and we consider the mapping $z \in \mathbb{R} \mapsto \psi(z) = (T(z), \mathbf{q}(z)) \in \text{Ran}(A_D)$,*

$$(21) \quad \psi(z) = f(z)\varphi^D + \sum_{n \in \mathbb{Z}^*} \alpha_n c_n(z)\Psi_n,$$

We have,

$$(22) \quad \psi \in C^1(\mathbb{R}, \mathcal{H}) \cap C^0(\mathbb{R}, D(\overline{A})), \quad \frac{d}{dz}\psi = \overline{A}\psi \quad \text{on } \mathbb{R},$$

and T is the solution to the Dirichlet problem (1) (11).

The regularity estimate above simply means that $z \mapsto T(z)$ is C^1 in $L^2(\Omega)$ and continuous in $H^1(\Omega)$.

If we moreover assume that $f \in C^2(\mathbb{R})$ with f'' bounded we get the additional regularity,

$$(23) \quad \psi \in C^2(\mathbb{R}, \mathcal{H}) \cap C^1(\mathbb{R}, D(\overline{A})).$$

This means that $z \mapsto T(z)$ is C^2 in $L^2(\Omega)$, C^1 in $H^1(\Omega)$ and that $z \mapsto k\nabla T(z)$ is continuous in $H_{\text{div}}(\Omega)$. With this assumption T is a strong solution to equation (1), as stated in lemma, 1.1.

The definition of the temperature $T(z)$ associated to ψ in (21) can be precised thanks to remark 3.1. We have,

$$T(z, x) = f(z) + \sum_{n \in \mathbb{Z}^*} \alpha_n c_n(z) T_n(x).$$

Moreover far-field estimates on the temperature can be derived from this expression under suitable assumptions on f . Roughly speaking, if $f(z) \rightarrow f(+\infty)$ as $z \rightarrow +\infty$ then we also have $T(z) \rightarrow f(+\infty)$. If we instead have a linear growth of f at $+\infty$, then $T(z)$ verifies a similar asymptote. This is precised in the following corollary.

Corollary 3.3. *We assume $f \in C^1(\mathbb{R})$ with f' bounded.*

If $\int_0^{+\infty} |f'| dz < +\infty$, then f has a limit in $+\infty$ and:

$$T(z) \xrightarrow{z \rightarrow +\infty} f(+\infty) \quad \text{in } L^2(\Omega).$$

We moreover assume $f \in C^2(\mathbb{R})$ with f'' bounded.

If $\int_0^{+\infty} |f''| dz < +\infty$, then f' has a limit in $+\infty$ and:

$$\partial_z T(z) \xrightarrow{z \rightarrow +\infty} f'(+\infty), \quad T(z) \underset{z \rightarrow +\infty}{\sim} f(z) + f'(+\infty)u^D \quad \text{in } L^2(\Omega),$$

with u^D defined in remark 3.1: $\text{div}(k\nabla u^D) = v$ and $u^D \in H_0^1(\Omega)$.

The regularity assumption on f can be weakened. In particular jumps of f can be taken into account. We still can derive solutions when $f' = g + \delta$ with g continuous and bounded and δ a Dirac-type distribution. The functions $c_n(z)$ in (20) can be defined in this framework as well as the mapping ψ in (21). With such a boundary data ψ remains continuous in \mathcal{H} but is only differentiable outside the support of δ . These properties are detailed in the corollary 3.4

Similarly jumps on f' can be taken into account. Taking now $f'' = g + \delta$ as previously, then $T(z)$ remains C^2 in $L^2(\Omega)$, C^1 in $H^1(\Omega)$ and $k\nabla T(z)$ remains C^0 in $H_{\text{div}}(\Omega)$ outside the support of δ . These properties are detailed in the corollary 3.7.

Corollary 3.4. *Assume that $f(z) = \omega(z)$ with $\omega(z) = 1$ if $z < 0$ and $\omega(z) = 0$ otherwise, so that $f' = -\delta_0$. The computation of the functions $c_n(z)$ in (20) leads to the following definition of $\psi(z) = (T(z), \mathbf{q}(z))$:*

$$(24) \quad \psi(z) = \omega(z)\varphi^D - \omega(z) \sum_{n < 0} \alpha_n e^{\lambda_n z} \Psi_n + (1 - \omega(z)) \sum_{n > 0} \alpha_n e^{\lambda_n z} \Psi_n.$$

We have,

$$\psi \in C^0(\mathbb{R}, \mathcal{H}) \cap C^\infty(\mathbb{R}^*, D(\bar{A})) \quad \text{and} \quad \frac{d}{dz} \psi = \bar{A} \psi \quad \text{on } \mathbb{R}^*,$$

and T is the solution to the Dirichlet problem (1) (11) with $f = \omega$.

It has the following regularity: $z \mapsto T(z)$ is C^∞ on \mathbb{R}^ in $H^1(\Omega)$ and $z \mapsto k\nabla T(z)$ is C^∞ on \mathbb{R}^* in $H_{\text{div}}(\Omega)$. It then is a strong solution on \mathbb{R}^* .*

At the origin $z = 0$, T is continuous in $L^2(\Omega)$.

Proof of proposition 3.2. Let us first prove the regularity estimates for ψ in equation (21). The regularity for $z \mapsto f(z)\varphi^D$ is clear.

We then have to prove that $z \mapsto \sum_{n \in \mathbb{Z}^*} \alpha_n c_n(z) \Psi_n \in C^1(\mathbb{R}, \mathcal{H}) \cap C^0(\mathbb{R}, D(A_D))$. From (8) (9), it suffices to prove that the two series $\sum_{n \in \mathbb{Z}^*} |\lambda_n \alpha_n c_n(z)|^2$ and $\sum_{n \in \mathbb{Z}^*} |\alpha_n c'_n(z)|^2$ are uniformly converging. We already have from lemma 3.1 that $\sum_{n \in \mathbb{Z}^*} |\alpha_n|^2 < +\infty$. From the definition (20) we obtain the rough upper bound $|\lambda_n c_n(z)| \leq \|f'\|_{L^\infty}$, that also implies, $|c'_n| = |\lambda_n c_n - f'| \leq 2\|f'\|_{L^\infty}$. The uniform convergence follows from these two upper bounds.

The boundary condition (11) follows from $\psi(z) - f(z)\varphi^D = \sum_{n \in \mathbb{Z}^*} \alpha_n c_n(z) \Psi_n \in D(A_D) = H_0^1(\Omega) \times H_{\text{div}}(\Omega)$. This implies $\psi(z) - f(z)\varphi^D \in H_0^1(\Omega) \times H_{\text{div}}(\Omega)$ and therefore $T|_{\partial\Omega} = f(z)$ by definition (15) of φ^D .

Let us now prove that $d\psi/dz = \bar{A}\psi$. On one hand, since $\bar{A}\varphi^D = 0$ we have,

$$\bar{A}\psi = \bar{A}\left(\sum_{n \in \mathbb{Z}^*} \alpha_n c_n(z) \Psi_n\right) = \sum_{n \in \mathbb{Z}^*} \lambda_n \alpha_n c_n(z) \Psi_n,$$

because $\sum_{n \in \mathbb{Z}^*} \alpha_n c_n(z) \Psi_n \in D(A_D)$. On the other hand,

$$\begin{aligned} \frac{d}{dz}\psi &= f'(z)\varphi^D + \sum_{n \in \mathbb{Z}^*} \alpha_n c'_n(z) \Psi_n = f'(z)\varphi^D + \sum_{n \in \mathbb{Z}^*} \alpha_n (-f'(z) + \lambda_n c_n(z)) \Psi_n \\ &= f'(z)(\varphi^D - \sum_{n \in \mathbb{Z}^*} \alpha_n \Psi_n) + \bar{A}\psi. \end{aligned}$$

This gives $d\psi/dz = \bar{A}\psi$ with (14).

Now assume that $f \in C^2(\mathbb{R})$ with f'' bounded. By integrating by part in (25) we get for $n < 0$:

$$c_n(z) = \frac{1}{\lambda_n} f'(z) + \frac{1}{\lambda_n} \int_z^{+\infty} f''(\xi) e^{\lambda_n(z-\xi)} d\xi.$$

With $c'_n = \lambda_n c_n - f'$ we get,

$$c'_n(z) = \int_z^{+\infty} f''(\xi) e^{\lambda_n(z-\xi)} d\xi.$$

It follows that $|\lambda_n c'_n(z)| \leq \|f''\|_{L^\infty}$. Since $c''_n = \lambda_n c'_n - f''$ we also get the second upper bound $|c''_n(z)| \leq 2\|f''\|_{L^\infty}$.

We have the same upper bounds for $n > 0$, they imply that the two series $\sum_{n \in \mathbb{Z}^*} |\lambda_n \alpha_n c'_n(z)|^2$ and $\sum_{n \in \mathbb{Z}^*} |\alpha_n c''_n(z)|^2$ are uniformly converging. With (8) (9), this respectively ensures that $z \mapsto \sum_{n \in \mathbb{Z}^*} \alpha_n c_n(z) \Psi_n$ is C^1 in $D(\bar{A})$ and C^2 in \mathcal{H} . \square

Proof of corollary 3.3. We assume that $\int_0^{+\infty} |f'| dz < +\infty$. It implies that $\varepsilon(z) = \sup_{[z, +\infty)} |f'| \rightarrow 0$ as $z \rightarrow +\infty$.

Let us prove that the functions $(c_n(z))$ uniformly converges towards 0 as $z \rightarrow +\infty$.

With $\sum_{n \in \mathbb{Z}^*} |\alpha_n|^2 < +\infty$, this will ensure that,

$$\sum_{n \in \mathbb{Z}^*} \alpha_n c_n(z) \Psi_n \xrightarrow{z \rightarrow +\infty} 0 \text{ in } \mathcal{H},$$

which implies that $T(z) \rightarrow f(+\infty)$ in $L^2(\Omega)$.

First for $n < 0$ (and so $\lambda_n > 0$), we have:

$$|c_n(z)| \leq \int_z^{+\infty} |f'(\xi)| e^{-\lambda_n \xi} d\xi e^{\lambda_n z} \leq \varepsilon(z) \left[\frac{e^{-\lambda_n \xi}}{-\lambda_n} \right]_z^{+\infty} e^{\lambda_n z} = \varepsilon(z)/\lambda_n,$$

that implies uniform convergence to 0 for $n < 0$.

Now for $n > 0$ (and so $\lambda_n < 0$), we have for any $z_0 < z$:

$$|c_n(z)| \leq \int_{-\infty}^{z_0} |f'(\xi)| e^{-\lambda_n \xi} d\xi e^{\lambda_n z} + \int_{z_0}^z |f'(\xi)| e^{-\lambda_n \xi} d\xi e^{\lambda_n z}.$$

The second integral is easy to bound: since $-\lambda_n > 0$, we have $0 < e^{-\lambda_n \xi} < e^{-\lambda_n z}$ on $[z_0, z]$ and so:

$$\int_{z_0}^z |f'(\xi)| e^{-\lambda_n \xi} d\xi e^{\lambda_n z} \leq \int_{z_0}^z |f'(\xi)| d\xi \leq \int_{z_0}^{+\infty} |f'(\xi)| d\xi.$$

We now bound the first integral,

$$\int_{-\infty}^{z_0} |f'(\xi)| e^{-\lambda_n \xi} d\xi e^{\lambda_n z} \leq \|f'\|_{\infty} \left[\frac{e^{-\lambda_n \xi}}{-\lambda_n} \right]_{-\infty}^{z_0} e^{\lambda_n z} = \|f'\|_{\infty} \frac{e^{\lambda_n(z-z_0)}}{|\lambda_n|} \leq \|f'\|_{\infty} \frac{e^{\lambda_1(z-z_0)}}{|\lambda_1|},$$

using $\lambda_n < \lambda_1 < 0$ for $n > 0$ and $z - z_0 > 0$. For a given $\varepsilon > 0$, we can find z_0 so that $\int_{z_0}^{+\infty} |f'(\xi)| d\xi < \varepsilon$ and we can find $z_1 > z_0$ so that for all $z > z_1$ we have $\|f'\|_{\infty} e^{\lambda_1(z-z_0)}/|\lambda_1| < \varepsilon$. It follows that $|c_n(z)| < 2\varepsilon$ for all $z > z_1$ and all $n > 0$.

In case $f \in C^2(\mathbb{R})$ with f'' bounded, it has been proved in the proof for proposition 3.2 that,

$$c'_n(z) = \int_z^{+\infty} f''(\xi) e^{\lambda_n(z-\xi)} d\xi, \quad c'_n(z) = - \int_{-\infty}^z f''(\xi) e^{\lambda_n(z-\xi)} d\xi,$$

respectively for $n < 0$ and $n > 0$. Thus the same arguments as in the previous case prove that,

$$\sum_{n \in \mathbb{Z}^*} \alpha_n c'_n(z) \Psi_n \xrightarrow{z \rightarrow +\infty} 0 \text{ in } \mathcal{H},$$

so that $\partial_z T \rightarrow f'(+\infty)$ as $z \rightarrow +\infty$.

Now we have $c_n = c'_n/\lambda_n + f'/\lambda_n$:

$$\sum_{n \in \mathbb{Z}^*} \alpha_n c_n(z) \Psi_n = \sum_{n \in \mathbb{Z}^*} \alpha_n \frac{c'_n(z)}{\lambda_n} \Psi_n + f'(z) \sum_{n \in \mathbb{Z}^*} \frac{\alpha_n}{\lambda_n} \Psi_n.$$

The first sum converges to zero as $z \rightarrow +\infty$. The second one towards $f'(+\infty) A_D^{-1} \varphi^D$, with $A_D^{-1} \varphi^D = \sum_{n \in \mathbb{Z}^*} \alpha_n \Psi_n / \lambda_n$ by definition. We search for $(s, \mathbf{q}) \in D(A_D)$ satisfying $\bar{A}(s, \mathbf{q}) = \varphi^D$, it satisfies $s \in H_0^1(\Omega)$ and $k \nabla s = k \nabla u^D$ so that $s = u^D$. Finally we showed that $\sum_{n \in \mathbb{Z}^*} \alpha_n c_n(z) T_n \rightarrow f'(+\infty) u^D$ as $z \rightarrow +\infty$ which ends the proof. \square

Proof of corollary 3.4. The regularity of ψ in equation (24) follows from the observation that, since $\lambda_n \rightarrow +\infty$ as $n \rightarrow -\infty$ and since $\sum_{n \in \mathbb{Z}^*} |\alpha_n|^2 < +\infty$, then the series $\sum_{n < 0} |\lambda_n^k \alpha_n e^{\lambda_n z}|^2$ is uniformly converging for $z \in (-\infty, -\varepsilon)$ for all $\varepsilon > 0$ and all $k \in \mathbb{N}$. As a result with (9), $z \in (-\infty, 0) \mapsto \sum_{n < 0} \alpha_n e^{\lambda_n z} \Psi_n$ is infinitely differentiable in $D(A_D)$. The same result holds for $z \in (0, +\infty) \mapsto \sum_{n > 0} \alpha_n e^{\lambda_n z} \Psi_n$.

The continuity of ψ at the origin in \mathcal{H} -norm follows from (14).

The proof that $d\psi/dz = \bar{A}\psi$ on \mathbb{R}^* and that $T = w$ on $\partial\Omega$ is identical with the proof of proposition 3.2. \square

3.3. The Neumann problem for $Q \neq 0$. We simply denote here $\lambda_n = \lambda_n^N$, $\Psi_n = \Psi_n^N$ and $\alpha_n = \alpha_n^N$. The functions $c_n(z)$ for $n \in \mathbb{Z}^*$ are alternatively defined as,

$$(25) \quad c_n(z) = \int_z^{+\infty} f(\xi) e^{\lambda_n(z-\xi)} d\xi \quad \text{if } n < 0, \quad c_n(z) = - \int_{-\infty}^z f(\xi) e^{\lambda_n(z-\xi)} d\xi \quad \text{if } n > 0,$$

For f bounded they are well defined, bounded, differentiable and verify $c'_n = \lambda_n c_n - f$.

Proposition 3.5. *We assume that $f \in C^1(\mathbb{R})$ and that both f and f' are bounded. We introduce F a primitive of f .*

Let us consider the mapping $z \in \mathbb{R} \mapsto \psi(z) \in \text{Ran}(A_N)$,

$$(26) \quad \psi(z) = F(z)\varphi^N + \sum_{n \in \mathbb{Z}^*} \alpha_n c_n(z) \Psi_n,$$

we have

$$\psi \in C^2(\mathbb{R}, \mathcal{H}) \cap C^1(\mathbb{R}, D(\bar{A})) \quad \text{and} \quad \frac{d}{dz} \psi = \bar{A} \psi \quad \text{on } \mathbb{R},$$

and T is a strong solution to the Neumann problem (1) (12).

The regularity of the solution to the Neumann problem is increased by one degree comparatively to the Dirichlet case. This comes from the definition of the functions $(c_n(z))$ that are defined with respect to f (equation (25)) in the Neumann case whereas they are defined with the help of f' (equation (20)) for the Dirichlet problem.

Another interesting difference with the Dirichlet case is that the temperature now is defined up to an additive constant and we have an infinite set of solutions T . Precisely with remark 3.1, the temperature T can be written as:

$$(27) \quad T(z, x) = \frac{P}{Q} F(z) + \sum_{n \in \mathbb{Z}^*} \alpha_n c_n(z) T_n(x),$$

where F is defined up to an additive constant. This was expected since any constant C is solution to (1) with homogeneous Neumann boundary condition on $\mathbb{R} \times \partial\Omega$. We however have uniqueness for the gradient of T that describes the heat exchanges. To have a unique determination of the temperature, the constant in F has to be set. This means adding some normalisation condition on the temperature (indeed in the Dirichlet case this normalisation also is present but implicitly). Such a normalisation can be done considering the far field temperature with suitable condition on f (roughly $f \rightarrow 0$ at one end of the duct at least). This is precised in the following corollary

Corollary 3.6. *We assume as in proposition 3.5 that $f \in C^1(\mathbb{R})$ and that both f and f' are bounded.*

If $\int_0^{+\infty} |f| dz < +\infty$, then F has a limit in $+\infty$ and:

$$T(z) \xrightarrow{z \rightarrow +\infty} F(+\infty) \frac{P}{Q} \quad \text{in } \mathcal{H}.$$

The constant $F(+\infty)$ then can be fixed by a normalisation condition on T at $z = +\infty$.

If $\int_0^{+\infty} |f'| dz < +\infty$, then f has a limit in $+\infty$ and:

$$\partial_z T(z) \xrightarrow{z \rightarrow +\infty} f(+\infty) \frac{P}{Q}, \quad T(z) \underset{z \rightarrow +\infty}{\sim} F(z) + f(+\infty) u^N \quad \text{in } L^2(\Omega),$$

with u^N defined in remark 3.1: $Q \operatorname{div}(k \nabla u^N) = Pv$ and $k \nabla u^N \cdot \mathbf{n} = 1$ on $\partial\Omega$ with the normalisation condition (17).

Solutions can again be obtained with weaker regularity on the boundary data f : precisely with $f' = g + \delta$ with g continuous and bounded and with δ a Dirac-type distribution. The functions $c_n(z)$ in (25) can be defined in this framework as well as the function ψ in (26). With such a boundary data, ψ remains C^1 in \mathcal{H} on \mathbb{R} but is only C^2 in \mathcal{H} and C^1 in $D(\bar{A})$ outside the support of δ . These properties are detailed in the corollary 3.7. Transposed to the Dirichlet context this corresponds to the case $f'' = g + \delta$.

Corollary 3.7. *Assume that $f(z) = \omega(z)$ with $\omega(z) = 1$ if $z < 0$ and $\omega(z) = 0$ otherwise, so that $f' = -\delta_0$. The computation of the functions $c_n(z)$ in (25) in this case leads to the following definition of $\psi(z) = (T(z), \mathbf{q}(z))$:*

$$(28) \quad \psi(z) = \begin{cases} A_N^{-1} \varphi^N + z \varphi^N - \sum_{n < 0} \alpha_n e^{\lambda_n z} \Psi_n / \lambda_n & \text{if } z < 0 \\ \sum_{n > 0} \alpha_n e^{\lambda_n z} \Psi_n / \lambda_n & \text{if } z > 0 \end{cases},$$

where $A_N^{-1} \varphi^N = \sum_{n \in \mathbb{Z}^*} \alpha_n \Psi_n / \lambda_n$ is well defined since $\varphi^N \in \operatorname{Ran}(A_N)$.

We have,

$$\psi \in C^1(\mathbb{R}, \mathcal{H}) \cap C^0(\mathbb{R}, D(\bar{A})) \cap C^\infty(\mathbb{R}^*, D(\bar{A})),$$

and T is a solution to the Neumann problem (1) (12) with $f = \omega$.

It has the following regularity: $z \mapsto T(z)$ is C^∞ on \mathbb{R}^* in $H^1(\Omega)$ and $z \mapsto k \nabla T(z)$ is C^∞ on \mathbb{R}^* in H_{div} -norm. At the origin $z = 0$, T is C^1 in $L^2(\Omega)$ and $k \nabla T$ is continuous in $L^2(\Omega)$.

Proof of proposition 3.5. Let ψ be given by equation (26). Since $F'' = f' \in L^\infty(\mathbb{R})$, with proposition 3.2, relations (22) and (23) hold for ψ . It only remains to prove that T satisfies (12)

We have $\partial_z \psi = f(z) \varphi^N + \sum_{n \in \mathbb{Z}^*} \alpha_n c'_n(z) \Psi_n$. In the proof of proposition 3.2 we showed that $|\lambda_n c'_n(z)| \leq \|F''\|_{L^\infty}$, consequently $\sum_{n \in \mathbb{Z}^*} \alpha_n c'_n(z) \Psi_n \in D(A_N)$. It follows that on $\partial\Omega$ we have $\partial_z \mathbf{q} \cdot \mathbf{n} = f(z) k \nabla u^N \cdot \mathbf{n} = f(z)$ using (16). With $\partial_z \mathbf{q} = k \nabla T$ we obtain the desired boundary condition (12). \square

Proof of corollary 3.6. Replacing f by F in the proof of corollary 3.3 gives that:

- if $\int_0^{+\infty} |f| dz < +\infty$ then $\sum_{n \in \mathbb{Z}^*} \alpha_n c_n(z) \Psi_n \rightarrow 0$ as $z \rightarrow +\infty$,
- if $\int_0^{+\infty} |f'| dz < +\infty$ then $\sum_{n \in \mathbb{Z}^*} \alpha_n c'_n(z) \Psi_n \rightarrow 0$ and $\sum_{n \in \mathbb{Z}^*} \alpha_n c_n(z) \Psi_n \rightarrow f(+\infty) A_N^{-1} \varphi^N$ as $z \rightarrow +\infty$.

It remains to characterise $(s, \mathbf{q}) = A_N^{-1} \varphi^N$. We use the determination of φ^N in remark 3.1: $k \nabla s = k \nabla u^N$ so that $s = u^N + C$ with C a constant. We now have $v(u^N + C) - \operatorname{div}(\mathbf{q}) = kP/Q$. Integrating over Ω and since $\mathbf{q} \in H_{\operatorname{div}}^0(\Omega)$ we get:

$$Q \int_{\Omega} v(u^N + C) dx = P \int_{\Omega} k dx,$$

so that, with the chosen normalisation (17), $C = 0$. \square

Proof of corollary 3.7. Since $F' \in L^\infty \mathbb{R}$ we can apply the first part of proposition 3.2 so that (22) holds for ψ in equation (28). The regularity estimates on \mathbb{R}^* are identical to the ones in the Dirichlet case.

Let us examine the boundary condition.

$$\frac{d}{dz}\psi = \begin{cases} \varphi^N - \sum_{n<0} \alpha_n e^{\lambda_n z} \Psi_n & \text{if } z < 0 \\ \sum_{n>0} \alpha_n e^{\lambda_n z} \Psi_n & \text{if } z > 0 \end{cases}.$$

We clearly have $d\psi/dz - \omega(z)\varphi^N \in D(A_N)$ for $z \neq 0$. As a result on the boundary $\partial\Omega$, $k\nabla T \cdot \mathbf{n} = \partial_z \mathbf{q} \cdot \mathbf{n} = \omega(z)k\nabla u^N \cdot \mathbf{n} = \omega(z)$ with (16). \square

3.4. The Neumann problem for $Q = 0$. Let us adapt the previous results to the particular case $Q = 0$: notations are unchanged as for the Neumann problem with $Q \neq 0$.

We recall that the definition of $\varphi^N = (s^N, k\nabla u^N) = \sum_{n \in \mathbb{Z}^*} \alpha_n \Psi_n$ is singular in this case. As stated in lemma 3.1 and in remark 3.1, $s^N = au_0 + b$ with a and b two constants given in (18) (19) and u_0 defined in (5). We have $\varphi^N \in \text{Ran}(A_N)$, so that $(\varphi^N | \Psi_0)_{\mathcal{H}} = 0$, and $\bar{A}\varphi^N = a\Psi_0$. We also recall that $\Psi_0 = (1, k\nabla u_0)$ and the definition of $\text{Ran}(A_N)$ in corollary 2.2: $R_N = \text{Ran}(A_N) \oplus \text{Span}(\Psi_0)$.

Proposition 3.8. *The results of proposition 3.5 extends to the case $Q = 0$ with the alternative definition of $\psi : z \in \mathbb{R} \mapsto R_N$:*

$$\psi(z) = aG(z)\Psi_0 + F(z)\varphi^N + \sum_{n \in \mathbb{Z}^*} \alpha_n c_n(z)\Psi_n,$$

with $G : \mathbb{R} \mapsto \mathbb{R}$ satisfying $G' = F$.

The case $Q = 0$ presents singular characteristics that deserves attention. The temperature reads:

$$T(z) = aG(z) + F(z)(au_0 + b) + \sum_{n \in \mathbb{Z}^*} \alpha_n c_n(z)T_n.$$

When compared to (27) we see that the leading term as $z \rightarrow \pm\infty$ in the temperature are different: if $Q \neq 0$ it is $F(z)P/Q$ whereas when $Q = 0$ it is $aG(z)$. Assume for example that $f = 0$ in a neighbourhood of $+\infty$: in this case $T(z)$ will converge to some limit if $Q \neq 0$ whereas for $Q = 0$ it will present a linear growth. Similarly if $f = L \neq 0$ in a neighbourhood of $+\infty$: in this case $T(z)$ will present a linear growth if $Q \neq 0$ whereas for $Q = 0$ this growth will instead be parabolic. These two properties being consequences of corollary 3.6.

A second important difference is that the solution now is defined up to two constant, which was expected since any function of the form $C_1(z + u_0) + C_2$ is solution of the homogeneous Neumann problem. Thus two solutions of the problem may have different gradient and then correspond to different heat exchanges. To clarify this we rewrite the temperature as,

$$(29) \quad T(z) = C_1(z + u_0) + C_2 + aG(z) + F(z)(au_0 + b) + \sum_{n \in \mathbb{Z}^*} \alpha_n c_n(z)T_n,$$

$$\partial_z T(z) = C_1 + aF(z) + f(z)(au_0 + b) + \sum_{n \in \mathbb{Z}^*} \alpha_n c'_n(z)T_n.$$

imposing $F(0) = G(0) = 0$ and with C_1, C_2 two constants.

Assume that both $\int_0^{+\infty} |f|dz < +\infty$ and $\int_0^{+\infty} |f'|dz < +\infty$ (physically we could say

$f = 0$ at one end of the duct). Then similar far field estimates as in corollary 3.6 lead to,

$$\partial_z T(z) \xrightarrow{z \rightarrow +\infty} C_1 + a \int_0^{+\infty} f dz.$$

This is another important difference with the case $Q \neq 0$ where this limit would be fixed here, equal to $f(+\infty)P/Q$. In the case $Q \neq 0$ this limit is free. We can impose the heat flux at $+\infty$: such an additional condition determines C_1 . With this supplementary condition, we conserve an infinite set of solutions depending on C_2 : but two such solutions have equal gradients and now correspond to equal heat exchanges.

Proof of proposition 3.8. All the regularity estimates will still hold in this case: they only depend on the $c_n(z)$ whose definition remained unchanged. The boundary condition (12) will also be satisfied since $\Psi_0 = (1, k\nabla u_0)$ and u_0 satisfies a zero flux condition on $\partial\Omega$.

We then only have to prove that $\partial_z \psi = \bar{A}\psi$. On one hand, since $\bar{A}\varphi^N = a\Psi_0$ and $\bar{A}\Psi_0 = 0$ we have

$$\bar{A}\psi = aF(z)\Psi_0 + \sum_{n \in \mathbb{Z}^*} \lambda_n \alpha_n c_n(z) \Psi_n.$$

On the other hand,

$$\begin{aligned} \frac{d}{dz} \psi &= aF(z)\Psi_0 + f(z)\varphi^N + \sum_{n \in \mathbb{Z}^*} \alpha_n c'_n(z) \Psi_n \\ &= aF(z)\Psi_0 + f(z)\varphi^N + \sum_{n \in \mathbb{Z}^*} \alpha_n (-f(z) + \lambda_n c_n(z)) \Psi_n \\ &= f(z) \left(\varphi^N - \sum_{n \in \mathbb{Z}^*} \alpha_n \Psi_n \right) + \bar{A}\psi. \end{aligned}$$

This gives $d\psi/dz = \bar{A}\psi$ with (14). □

4. SOLUTIONS ON SEMI-INFINITE DOMAINS

We here consider the case $I = \mathbb{R}^+ = (0, +\infty)$.

Being given a function $f : \mathbb{R}^+ \mapsto \mathbb{R}$, we look for a solution T to (1) associated either with the Dirichlet problem (11) or with the Neumann problem (12) on $\partial\Omega \times \mathbb{R}^+$ and either with a Dirichlet or a Neumann entry condition at $z = 0$: for some $E \in L^2(\Omega)$,

$$(30) \quad \textit{Dirichlet entry condition:} \quad T(x, 0) = E(x) \quad \text{for } x \in \Omega,$$

$$(31) \quad \textit{Neumann entry condition:} \quad \partial_z T(x, 0) = E(x) \quad \text{for } x \in \Omega.$$

4.1. Preliminary result. To derive solutions on semi-infinite domains a supplementary result is needed, this result is the main topic of [2] by J. Fehrenbach et al. It could be resumed as follows:

- we already know that $(\Psi_n^D)_{n \in \mathbb{Z}^*} = (T_n^D, \mathbf{q}_n^D)_{n \in \mathbb{Z}^*}$ forms a Hilbert basis of $\text{Ran}(A_D)$,
- in addition, $(T_n^D)_{n > 0}$ forms a complete basis of $L^2(\Omega)$ (only the positive indexes n have been kept), it is however no longer an orthogonal basis.

More precisely we consider the coefficients $\kappa_{ij} = \int_{\Omega} k T_i^D T_j^D dx$ for $i, j \in \mathbb{Z}^*$ and consider the matrices $K = (\kappa_{ij})_{i,j>0}$, $K_n = (\kappa_{ij})_{1 \leq i,j \leq n}$. Let now $E \in L^2(\Omega)$ and consider the coefficients $v_i = \int_{\Omega} k E T_i^D dx$. We form the vectors $V = (v_i)_{i>0}$, $V_n = (v_i)_{1 \leq i \leq n}$.

Theorem 4.1 (J. Fehrenbach et al). *There exists a unique sequence $B = (\beta_i)_{i>0}$ so that*

$$E = \sum_{i>0} \beta_i T_i^D, \quad \sum_{n>0} |\beta_n|^2 < +\infty.$$

It is the unique solution to $KB = V$. Moreover for any $n > 0$, $K_n B_n = V_n$ has a unique solution. Denoting $B_n = (\beta_i^n)_{1 \leq i \leq n}$, we have that $\sum_{i=1}^n \beta_i^n T_i^D \rightarrow E$ in L^2 -norm (equivalently, $B_n \rightarrow B$ in $l^2(\mathbb{N}^)$ -norm).*

The second part of the theorem provides an algorithm to approximate E using a decomposition on the n -first downstream modes T_n^D . The first part is the ingredient needed to derive solutions on semi-infinite domains.

This result is here enunciated in the Dirichlet case, it has only been proven in this case. We will assume that it also holds in the Neumann case, in the particular case $Q = 0$, the supplementary eigenvector Ψ_0 , for which $T_0(x) = 1$, has to be taken into account

4.2. The Dirichlet problem. We again simply denote $\lambda_n = \lambda_n^D$, $\Psi_n = \Psi_n^D$ and $\alpha_n = \alpha_n^D$. Still for simplicity we assume here that $f \in C^2([0, +\infty))$ with both f' and f'' bounded.

The functions $c_n(z)$ now are defined for $n \in \mathbb{Z}^*$ by,

$$c_n(z) = \int_z^{+\infty} f'(\xi) e^{\lambda_n(z-\xi)} d\xi \quad \text{if } n < 0, \quad c_n(z) = - \int_0^z f'(\xi) e^{\lambda_n(z-\xi)} d\xi \quad \text{if } n > 0.$$

They are well defined, bounded, differentiable and satisfy $c'_n = \lambda_n c_n - f'$. These functions only differ from the ones in equation (20) when $n > 0$, in particular we have $c_n(0) = 0$ for $n > 0$.

Consider the mapping $z \in \mathbb{R}^+ \mapsto \psi(z) = (T(z), \mathbf{q}(z)) \in \text{Ran}(A_D)$,

$$(32) \quad \psi(z) = f(z) \varphi^D + \sum_{n \in \mathbb{Z}^*} \alpha_n c_n(z) \Psi_n + \sum_{n>0} \beta_n e^{\lambda_n z} \Psi_n,$$

for some sequence $(\beta_n)_{n>0}$ satisfying $\sum_{n>0} |\beta_n|^2 < +\infty$.

When comparing (32) with the solution on infinite domain (21) we point out that here the functions $c_n(z)$ have an alternative definition for $n > 0$. We also underline that the additional term $\sum_{n>0} \beta_n e^{\lambda_n z} \Psi_n \in \text{Ran}(A_D)$ is well defined since $\lambda_n < 0$ for $n > 0$.

Proposition 4.2. *We have $\psi \in C^2(\mathbb{R}^+, \mathcal{H}) \cap C^1(\mathbb{R}^+, D(\bar{A}))$, $\partial_a \psi = \bar{A} \psi$ and $T(z)$ is a solution to the Dirichlet problem (1) (11).*

Considering $(\beta_n)_{n>0}$ the unique sequence given by theorem 4.1 so that,

$$\sum_{n>0} \beta_n T_n = E - f(0) - \sum_{n<0} \alpha_n c_n(0) T_n,$$

then $T(z)$ moreover satisfies the Dirichlet entry condition (30).

Now considering $(\beta_n)_{n>0}$ the unique sequence given by lemma 4.1 so that,

$$\sum_{n>0} \lambda_n \beta_n T_n = E - \sum_{n<0} \lambda_n \alpha_n c_n(0) T_n,$$

then $T(z)$ now satisfies the Neumann entry condition (31).

At the origin $z = 0$, we have convergence of $T(z)$ or $\partial_z T(z)$ towards E in L^2 -norm.

As in the infinite domain case, we could weaken a bit the regularity assumptions on f , allowing in particular jumps of f or of f' . We will not address this question here, referring to section 3 instead.

Far field estimates can be derived exactly as in corollary 3.3 (because $z \rightarrow \sum_{n>0} \beta_n e^{\lambda_n z} \Psi_n$ goes to 0 as well as all its derivatives as $z \rightarrow +\infty$). We only recall these estimates:

- if $\int_0^{+\infty} |f'| dz < +\infty$, then $T(z) \rightarrow f(+\infty)$ as $z \rightarrow +\infty$ in $L^2(\Omega)$,
- if $\int_0^{+\infty} |f''| dz < +\infty$, then $\partial_z T(z) \rightarrow f'(+\infty)$ and $T(z) \underset{z \rightarrow +\infty}{\sim} f(z) + f'(+\infty)u^D$ as $z \rightarrow +\infty$ in $L^2(\Omega)$ (with u^D defined in remark 3.1).

Proof. Let us decompose $\psi(z) = \psi_1(z) + \psi_2(z)$ with,

$$\psi_1(z) = f(z)\varphi^D + \sum_{n \in \mathbb{Z}^*} \alpha_n c_n(z) \Psi_n, \quad \psi_2(z) = \sum_{n>0} \beta_n e^{\lambda_n z} \Psi_n.$$

The first term ψ_1 can be analysed exactly as in the proof of proposition 3.2: with $f \in C^2([0, +\infty))$ and with both f' and f'' bounded we have $\psi_1 \in C^2([0, +\infty), \mathcal{H}) \cap C^1([0, +\infty), D(\bar{A}))$. Moreover $\partial_z \psi_1 = \bar{A}\psi_1$, and denoting $\psi_1 = (T_1, \mathbf{q}_1)$ then $T_1 = f(z)$ on $\partial\Omega$.

The second term ψ_2 in turn also can be analysed exactly as in the proof of corollary 3.4 (since $\sum_{n>0} |\beta_n|^2 < +\infty$): $\psi_2 \in C^\infty((0, +\infty), D(\bar{A}))$ and $\partial_z \psi_1 = \bar{A}\psi_1$. We also have $\psi_2 = (T_2, \mathbf{q}_2) \in D(A_D)$ so that $T_2 = 0$ on $\partial\Omega$.

It only remains to prove the entry conditions.

For the Dirichlet entry condition, since $\sum_{n>0} |\beta_n|^2 < +\infty$, ψ_2 is continuous at $z \rightarrow 0$ and $\psi_2(0) = \sum_{n>0} \beta_n \Psi_n$. It clearly follows that $T(z) \rightarrow E$ as $z \rightarrow 0$ in $L^2(\Omega)$.

For the Neumann entry condition, we now have that $\sum_{n>0} |\lambda_n \beta_n|^2 < +\infty$ so that $\partial_z \psi_2$ is continuous at $z = 0$ in \mathcal{H} with $\partial_z \psi_2(0) = \sum_{n>0} \lambda_n \beta_n \Psi_n$. We already have the continuity of $\partial_z \psi_1$ on $[0, +\infty)$ and $\partial_z \psi_1 = \bar{A}\psi_1$ so that $\partial_z \psi_1(0) = \sum_{n<0} \lambda_n \alpha_n c_n(0) \Psi_n$. As a result $\partial_z \psi$ is continuous in \mathcal{H} at $z = 0$ and:

$$\partial_z T(0) = \partial_z T_1(0) + \partial_z T_2(0) = \sum_{n<0} \lambda_n \alpha_n c_n(0) T_n + \sum_{n>0} \lambda_n \beta_n T_n = E,$$

□

4.3. The Neumann problem for $Q \neq 0$. We simply denote $\lambda_n = \lambda_n^N$, $\Psi_n = \Psi_n^N$ and $\alpha_n = \alpha_n^N$. We assume that $f \in C^1([0, +\infty))$ with both f and f' bounded.

The functions $c_n(z)$ now are defined for $n \in \mathbb{Z}^*$ by,

$$c_n(z) = \int_z^{+\infty} f(\xi) e^{\lambda_n(z-\xi)} d\xi \quad \text{if } n < 0, \quad c_n(z) = - \int_0^z f(\xi) e^{\lambda_n(z-\xi)} d\xi \quad \text{if } n > 0.$$

They are well defined, bounded, differentiable and satisfy $c'_n = \lambda_n c_n - f$. These functions only differs from the ones in equation (25) when $n > 0$, in particular we have $c_n(0) = 0$ for $n > 0$.

We consider the mapping $z \in \mathbb{R}^+ \mapsto \psi(z) = (T(z), \mathbf{q}(z)) \in \text{Ran}(A_N)$,

$$(33) \quad \psi(z) = F(z)\varphi^N + \sum_{n \in \mathbb{Z}^*} \alpha_n c_n(z) \Psi_n + \sum_{n>0} \beta_n e^{\lambda_n z} \Psi_n,$$

for $F' = f$ and for some sequence $(\beta_n)_{n>0}$ satisfying $\sum_{n>0} |\beta_n|^2 < +\infty$.

This mapping can be analysed exactly as in the Dirichlet problem: $\psi \in C^2(\mathbb{R}, \mathcal{H}) \cap C^1(\mathbb{R}, D(\bar{A}))$ and $\partial_z \psi = \bar{A}\psi$. Moreover the temperature T is a solution to the Neumann problem (1) (12). With remark 3.1 the temperature can be written as:

$$T = \frac{P}{Q}F(z) + \sum_{n \in \mathbb{Z}^*} \alpha_n c_n(z) T_n + \sum_{n > 0} \beta_n e^{\lambda_n z} T_n,$$

so that at the entry $z = 0$ we have:

$$\begin{aligned} T(0) &= \frac{P}{Q}F(0) + \sum_{n < 0} \alpha_n c_n(0) T_n + \sum_{n > 0} \beta_n T_n \\ \partial_z T(0) &= \sum_{n < 0} \lambda_n \alpha_n c_n(0) T_n + \sum_{n > 0} \lambda_n \beta_n T_n. \end{aligned}$$

Proposition 4.3. *Considering $(\beta_n)_{n > 0}$ the unique sequence given by theorem 4.1 so that,*

$$\sum_{n > 0} \beta_n T_n = E - PF(0)/Q - \sum_{n < 0} \alpha_n c_n(0) T_n,$$

then $T(z)$ is solution of the Neumann problem (1) (12) with the Dirichlet entry condition (30).

Now considering $(\beta_n)_{n > 0}$ the unique sequence given by lemma 4.1 so that,

$$\sum_{n > 0} \lambda_n \beta_n T_n = E - \sum_{n < 0} \lambda_n \alpha_n c_n(0) T_n,$$

then $T(z)$ is solution of the Neumann problem (1) (12) with the Neumann entry condition (31).

As for the Neumann problem on infinite domain, F is only determined up to a constant so that we have infinitely many solutions.

- For a Neumann entry condition, two solutions T_1 and T_2 will only differ from an additive constant C : $T_1 - T_2 = C$ so that the temperature gradient is uniquely determined. It is not necessary here to determine this constant to characterise the heat exchanges. To characterise the temperature, a normalisation condition is needed. Such a condition can be imposed at the duct end $z = +\infty$ with suitable assumptions on f : these far-field estimates are presented below.
- For a Dirichlet entry condition, two solutions T_1 and T_2 do not differ from a constant. They precisely satisfy for some constant $C \in \mathbb{R}$,

$$T_1 - T_2 = C + \sum_{n > 0} \gamma_n e^{\lambda_n z} T_n, \quad \text{with} \quad \sum_{n > 0} \gamma_n T_n = -C.$$

We could say here that $T_1 - T_2$ *asymptotically* differ from a constant, and that $\nabla T_1 - \nabla T_2$ *asymptotically* is zero. In this case the heat exchanges are not fully determined if the constant $F(0)$ is not fixed. Again a normalisation condition is needed for this and as we did see, such a normalisation cannot be held at the entry $z = 0$. It has to be searched instead at the duct end $z = +\infty$, which is only possible for a suitable choice of f .

We have the far field estimates:

- if $\int_0^{+\infty} |f| dz < +\infty$, then $T(z) \rightarrow F(+\infty)P/Q$ as $z \rightarrow +\infty$. In this case the constant on F can be fixed by a normalisation condition on T at $+\infty$.

- if $\int_0^{+\infty} |f'| dz < +\infty$, then $\partial_z T(z) \rightarrow f(+\infty)P/Q$ and $T(z) \underset{z \rightarrow +\infty}{\sim} F(z)P/Q + f(+\infty)u^N$ as $z \rightarrow +\infty$ in $L^2(\Omega)$ (with u^N defined in remark 3.1). In this case no normalisation condition is available to fix F .

4.4. The Neumann problem for $Q = 0$. We introduce a primitive F of f and a primitive G of F . We consider the mapping $z \in \mathbb{R}^+ \mapsto \psi(z) = (T(z), \mathbf{q}(z)) \in R_N$,

$$\psi(z) = aG(z)\Psi_0 + F(z)\varphi^N + \sum_{n \in \mathbb{Z}^*} \alpha_n c_n(z)\Psi_n + \sum_{n > 0} \beta_n e^{\lambda_n z} \Psi_n,$$

with a defined in equation (18) and for some sequence $(\beta_n)_{n > 0}$ satisfying $\sum_{n > 0} |\beta_n|^2 < +\infty$.

With the same justifications as in previously, if $f \in C^1([0, +\infty))$ with both f and f' bounded then $\psi \in C^2(\mathbb{R}, \mathcal{H}) \cap C^1(\mathbb{R}, D(\bar{A}))$ and $\partial_z \psi = \bar{A}\psi$. Moreover the temperature T is a solution to the Neumann problem (1) (12).

As in equation (29), imposing $F(0) = G(0) = 0$, we have for C_1 and C_2 two constants,

$$(34) \quad T = C_1(z + u_0) + C_2 + aG(z) + F(z)(au_0 + b) + \sum_{n \in \mathbb{Z}^*} \alpha_n c_n(z)T_n + \sum_{n > 0} \beta_n e^{\lambda_n z} T_n,$$

and at the entry $z = 0$ we have:

$$\begin{aligned} T(0) &= C_1 u_0 + C_2 + \sum_{n < 0} \alpha_n c_n(0)T_n + \sum_{n > 0} \beta_n T_n \\ \partial_z T(0) &= C_1 + \sum_{n < 0} \lambda_n \alpha_n c_n(0)T_n + \sum_{n > 0} \lambda_n \beta_n T_n. \end{aligned}$$

Proposition 4.4. *In the $Q = 0$ context theorem 4.1 has a particular translation: denoting $T_0 = 1 \in L^2(\Omega)$ the constant function, then the $(T_n)_{n \geq 0}$ form a complete basis of $L^2(\Omega)$.*

Let $C_1 \in \mathbb{R}$ be fixed and consider $(\beta_n)_{n \geq 0}$ be the unique sequence so that:

$$E = C_1 u_0 + \sum_{n < 0} \alpha_n c_n(0)T_n + \beta_0 T_0 + \sum_{n > 0} \beta_n T_n,$$

then $T(z)$ in (34) with $C_2 := \beta_0$ is a solution to the Neumann problem (1) (12) with the Dirichlet entry condition (30).

Consider now $(\beta_n)_{n \geq 0}$ be the unique sequence so that:

$$E = \sum_{n < 0} \lambda_n \alpha_n c_n(0)T_n + \beta_0 T_0 + \sum_{n > 0} \lambda_n \beta_n T_n,$$

then $T(z)$ in (34) with $C_1 := \beta_0$ is a solution to the Neumann problem (1) (12) with the Neumann entry condition (31) (and for any value of C_2).

The structure of the solutions in the particular case $Q = 0$ is again quite singular. The general solution (34) depends on two constants C_1 and C_2 .

Considering a Neumann entry condition determines C_1 . Then all the solution to the problem only differ from a constant and the heat exchanges are fully determined.

Considering a Dirichlet entry condition is more delicate. The constant C_1 is free. The second constant C_2 is determined via the entry condition: it depends both on C_1 and on $T(z = 0)$. One has one solution for each choice of C_1 and two different solutions do not simply differ from an additive constant. Precisely (as detailed

in the infinite domain case) two solutions asymptotically differ from a constant as $z \rightarrow +\infty$. As a result two different solutions induce two different heat exchanges, though asymptotically their gradients are equal.

To fix the constant C_1 a flux condition at $z = +\infty$ can be imposed, as in the infinite domain case. If we assume that both $\int_0^{+\infty} |f| dz < +\infty$ and $\int_0^{+\infty} |f'| dz < +\infty$ (More simply we could say that $f = 0$ close to $+\infty$), then

$$\partial_z T(z) \xrightarrow{z \rightarrow +\infty} C_1 + a \int_0^{+\infty} f dz.$$

5. NUMERICAL RESULTS

Our original purpose is the description of the heat exchanges in heating pipes and heat exchangers. In the previous two sections we derived analytical solutions for the temperature and the heat flux on such devices. In this section we provide numerical illustrations and we analyse the efficiency for these analytical solutions to describe the heat exchanges between a fluid flowing in a tube and the surrounding solid. We consider a tube-like geometry $\Omega \times I$ either with $I = \mathbb{R}$ or $I = \mathbb{R}^+$. The fluid is assumed to flow in a circular duct and then adopt a Poiseuille profile for its velocity v : denoting Pe the Péclet number,

$$v(x) = 2Pe \left(1 - \frac{\|x - x_0\|^2}{R^2}\right),$$

with x_0 the centre of the circular duct, R its radius. The thermal diffusivity is always taken as homogeneous, $k(x) = 1$.

We will consider three test cases. The first one is an axi-symmetric configuration aimed to compare the numerical results obtained with analytical ones. The second one is a periodic configuration describing a collection of parallel circular ducts. The last test case is a counter current configuration where $Q = 0$.

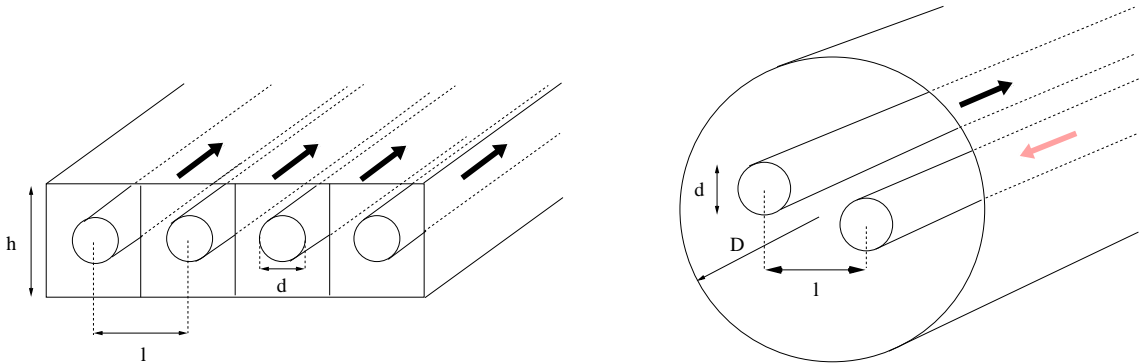

FIGURE 1. Geometrical configurations: the periodic test case is depicted on the left, the counter-current one on the right.

5.1. Implementation. For the hereby developed analytical solutions, their numerical approximation follows the same two steps. Firstly truncate the series for $-N \leq n \leq N$. Secondly approximate the N^{th} first eigenvalues λ_n and eigenfunctions Ψ_n . Once obtained these approximations, the coefficients α_n in (13) (only depending on the Ψ_n) and the functions $c_n(z)$ (that only depend on the λ_n and on the boundary data on $\partial\Omega \times I$) can in turn be approximated.

The numerical approximation of the λ_n and of the Ψ_n already has been studied in [2]. Let us recall its implementation.

In the Neumann case we have $\Psi_n \in R_N = \{(f, k\nabla s), f \in L^2(\Omega), s \in H^1(\Omega)\}$ (see corollary 2.2). In this case solving the eigenproblem is equivalent with: find $\Psi \in R_N \cap D(\bar{A})$ and $\lambda \in \mathbb{R}$ so that for all $\psi \in R_N$ we have:

$$(\bar{A}\Psi|\psi)_{\mathcal{H}} = \lambda (\Psi|\psi)_{\mathcal{H}}$$

Denoting the unknown $\Psi = (u, k\nabla s)$ and the test function $\psi = (\tilde{u}, k\nabla \tilde{s})$, this is also equivalent with finding $(u, s) \in H^1(\Omega) \times H^1(\Omega)$ and $\lambda \in \mathbb{R}$ so that for all $(\tilde{u}, \tilde{s}) \in H^1(\Omega) \times H^1(\Omega)$ we have:

$$S[(u, s), (\tilde{u}, \tilde{s})] = \lambda M[(u, s), (\tilde{u}, \tilde{s})]$$

with,

$$S[(u, s), (\tilde{u}, \tilde{s})] = \int_{\Omega} (vu\tilde{u} + k\nabla s \cdot \nabla \tilde{u} + k\nabla \tilde{s} \cdot \nabla u) dx,$$

$$M[(u, s), (\tilde{u}, \tilde{s})] = \int_{\Omega} (ku\tilde{u} + k\nabla s \cdot \nabla \tilde{s}) dx.$$

This problem is approximated considering a mesh of the domain Ω together with P^1 Lagrange finite element. The discrete problem reads,

$$S_h X = \lambda M_h X,$$

with S_h the (stiffness) matrix of the restriction of the bilinear form S to the $P^1 \times P^1$ Lagrange finite element discrete space, it is symmetric and positive (moreover definite if $Q \neq 0$) and with M_h the (mass) matrix of the restriction of the bilinear form M that is symmetric positive definite.

In practice the mesh as well as these two matrices are built using the finite element library *FreeFem++* [4], the resolution of the spectral problem $S_h X = \lambda M_h X$ uses the *arpack++* library¹.

5.2. Axi-symmetric configuration. We first consider an axi symmetric configuration: the domain Ω is the unit circle and the fluid part is a central circle with radius 1/2. For this geometry analytical definition of the eigenvalues and eigenfunctions are available following a technique introduced in [11]. These analytical solutions can be computed with an arbitrary small precision using a Maple code. On the other hand we presented in the previous section our strategy to approximate the λ_n and the Ψ_n on an arbitrary domain Ω using a mesh of Ω and a finite element solver. The aim of this test case is to evaluate the accuracy of this finite element solver. We compare the computed solutions with their analytical definition.

We set the boundary condition to the Neumann case. We first analyse the convergence of the computed eigenvalues: results are depicted on figure 2. A series of seven meshes has been considered with a mesh size h varying between 0.08 to 0.02. The relative error of the first downstream and upstream eigenvalues with respect to their exact values λ_1 and λ_{-1} has been computed on each of these meshes. We considered three values of the Péclet number: $Pe = 0.1$ (dominant diffusion), $Pe = 1$ and $Pe = 10$ (dominant convection). In all cases, the error goes to zero with an order two convergence with h .

¹Arpack software: <http://www.caam.rice.edu/software/ARPACK/>

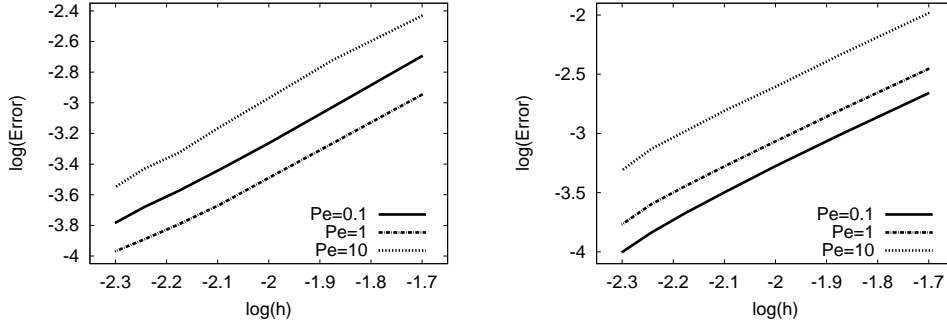

FIGURE 2. Eigenvalue convergence. The convergence of the first downstream (resp. upstream) computed eigenvalue towards its exact value λ_1 (resp. λ_{-1}) with respect to the mesh size h is here depicted on the left (resp. right) for three values of the Péclet number ($Pe = 0.1, 1$ and 10). The relative error is represented as a function of the mesh size h using a (decimal) Log/Log scale. Each plot displays the same linear behaviour with slope 2.

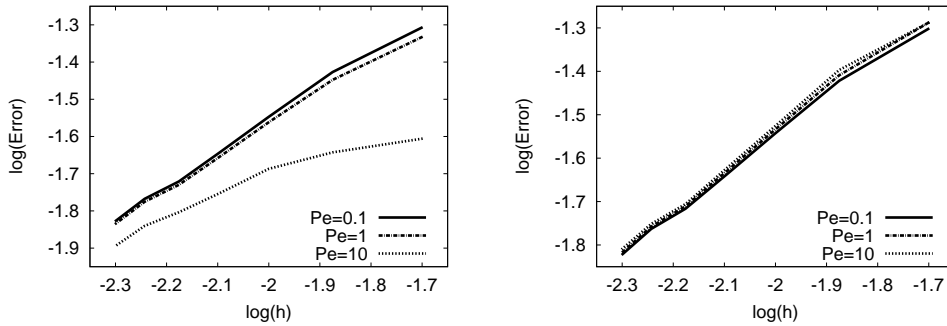

FIGURE 3. Convergence of the coefficients α_n . The convergence of the first downstream (resp. upstream) computed coefficients α_n towards its exact value α_1 (resp. α_{-1}) with respect to the mesh size is here depicted on the left (resp. right) for three values of the Péclet number ($Pe = 0.1, 1$ and 10). The relative error is represented as a function of the mesh size h using a (decimal) Log/Log scale.

With the same setting we analysed the convergence of the corresponding coefficients $\alpha_{\pm 1}$ that involve the boundary integral of $T_{\pm 1}$. The results are depicted on figure 3. The convergence for the α_n is of order 1 with the mesh size.

We now consider the two following configurations:

- the Neumann problem on infinite domain with a boundary data $f(z) = \omega(z)$ whose solution is given in corollary 3.7,
- the Neumann problem on semi-infinite domain with a zero flux condition on the outer wall $\partial\Omega \times \mathbb{R}^+$ and with a Neumann entry condition $\partial_z T(z=0) = 1$ in the fluid region and $\partial_z T(z=0) = 0$ in the solid one.

For these two configurations we evaluate the fluid-solid heat exchange in the $z > 0$ region. Denoting O the fluid region (the circle with centre 0 and radius $1/2$) it is

defined as:

$$\text{Flux}_{fluid/solid} := \int_0^{+\infty} \int_{\partial O} k \nabla T \cdot \mathbf{n} dl dz.$$

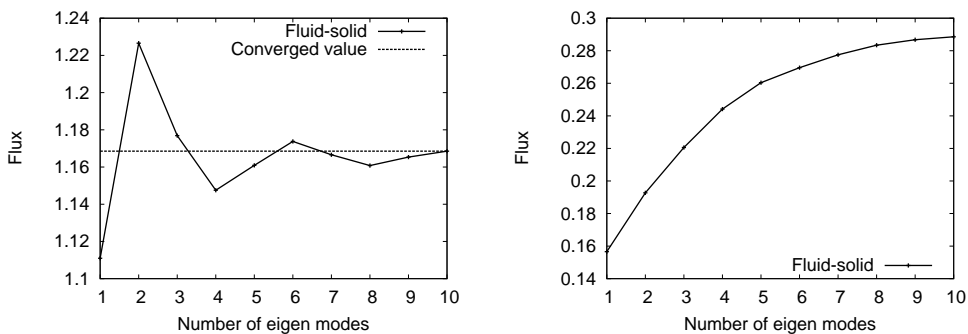

FIGURE 4. Evaluation of $\text{Flux}_{fluid/solid}$ according to the number of considered eigenmodes for the infinite domain configuration on the left and for the semi infinite one on the right, for both cases $Pe = 10$.

Mesh size	N. vertexes	N. modes	$\text{Flux}_{fluid/solid}$	Rel. error
0.083	557	3	1.313 1	13 %
0.042	2 083	3	1.208 8	4.1 %
0.021	8 694	4	1.162 4	0.07 %
0.011	32 411	6	1.180 3	1.6 %
0.005 2	133 454	9	1.165 0	0.23 %
0.003 5	295 250	11	1.166 0	0.38 %

TABLE 1. Convergence of the computed $\text{Flux}_{fluid/solid}$ with respect to the mesh size h . The number of vertexes of the mesh is reported in the second column. The third column corresponds to the number of considered modes. The computed flux and the associated relative error are reported in the last two columns.

We analyse the accuracy of the computation of $\text{Flux}_{fluid/solid}$ both with respect to the mesh size and to the number of considered eigenmodes N .

With the number of eigenmodes first. For both configurations the mesh is fixed to the finest one. The solutions for both configurations (equations (28) or (33) for the infinite and semi infinite configurations respectively) only involves the λ_n and the Ψ_n for $n > 0$. We consider the N -first modes only (i.e. $1 \leq n \leq N$) and approximate $\text{Flux}_{fluid/solid}$ using these N -modes. We then analyse the dependence of $\text{Flux}_{fluid/solid}$ with N : the results are depicted on figure 4. In both cases with quite a few modes we obtain an approximation of the flux of good accuracy: 1% (resp. 3%) of relative error with $N = 5$ (resp $N = 7$) for the infinite (resp semi infinite) configuration. The accuracy is higher for the infinite configuration, it is likely that this is due to the non-regularity of the entry condition for the semi infinite case.

We can develop a deeper insight on the fluid/solid computed flux convergence towards the exact flux in the infinite case where an accurate evaluation of the exact

flux can be obtained with the above mentioned analytical method: this exact value is evaluated to be 1.161 549 with a tolerance of $\pm 1.10^{-6}$, this value will be considered as a reference value. The comparison of the computed fluxes with this reference flux is presented in table 1. In this table are reported the mesh size together with the mesh number of vertexes. For each computation is also reported the significant number of computed eigenmodes: among the computed eigenvalues/eigenfunctions, most of them are associated to non axi-symmetric (i.e. periodic of type $f(r) \exp(ip\theta)$) and thus are not considered here. The flux computed with the significant modes is reported with its associated relative error. We again observe the convergence of the computed fluxes that oscillates around the limit flux. A quite small number of eigenmodes has to be taken into account to derive an approximation of good accuracy of the flux: to get a 1 % accurate approximation requires 5-6 modes, and to get a 5 % accurate approximation requires only 1-2 modes.

5.3. Periodic test case. We consider in this test case a periodic geometry depicted on figure 1. The geometry is infinite but periodic in the horizontal direction. It consists in a series of parallel circular ducts, in which a fluid is flowing, disposed inside a solid. The Péclet number for each duct is constant $Pe = 10$. The elementary domain is a square with one duct at its centre. Considering one elementary square, a Neumann boundary condition is considered on its top and bottom edges whereas periodic conditions on T and $\partial_x T$ are imposed on its left and right edges. In this case, the problem is no longer axi symmetric, as well as the eigenmodes.

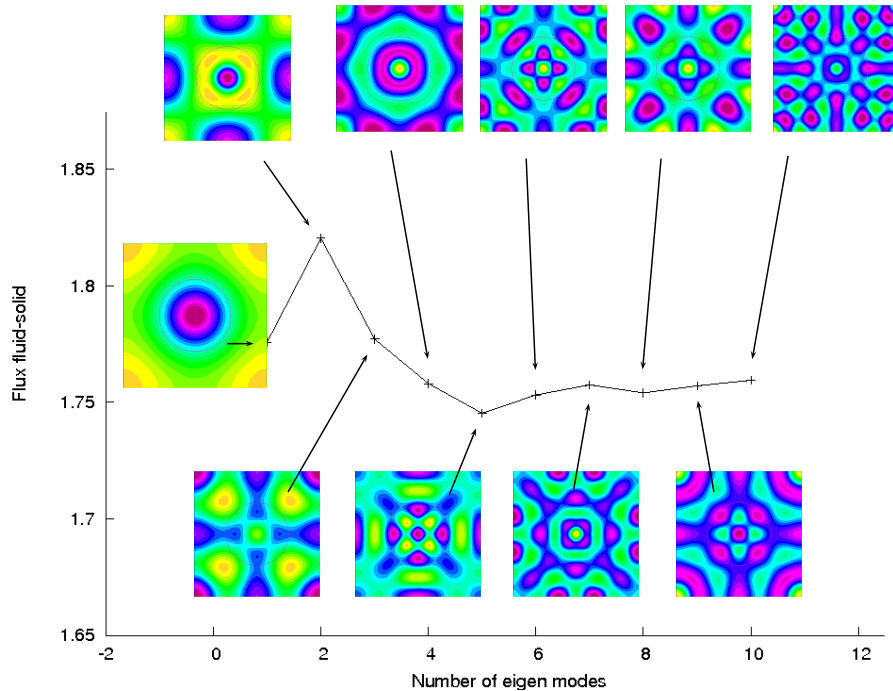

FIGURE 5. Flux Convergence for the periodic configuration depicted figure 1-left, with parameters $d = 1$, $h = 2$ and $l = 2$. Fluid-solid flux computed with the ten first eigenmodes and their visualisations

Here, we concentrate on a quantity of relevant interest towards applications: the exchange flux between the solid and the fluid compartments. Our focus will concern the modes contribution to the exchanges, and to what extent a mode truncation

could approximate the exchanger’s performance. It will also concern the numerical convergence associated with the finite element mesh refinement.

Figure 5 thus illustrates the contribution of the first ten most contributing modes to the exchange flux. One can note in this figure that the highest contribution, the lowest azimuthal apparent symmetry. The first contributing mode has a zeroth azimuthal symmetry, and increasing the mode contribution also increases the Fourier decomposition order of the azimuthal apparent symmetry. For the chosen convection dominated examined situation, $Pe = 10$, one can see that four modes are indeed enough to obtain an good estimate of the total flux within few percent precision. This is a very interesting observation, that convection dominated configuration provide an excellent performance for the proposed generalised mode decomposition, so that it is quite easy to get fast and accurate estimate of the exchange performance using the proposed formulation.

Mesh size	Number of vertexes	Flux fluid-solid	Convergence rate
1/20	1255	1.95895	–
1/40	4820	1.88159	–
1/80	18829	1.84777	2.29
1/160	74473	1.83051	1.96
1/320	298207	1.82017	1.67

TABLE 2. Periodic configuration. Flux convergence with respect to the mesh size h

In table 2 is reported the convergence of the fluid/solid heat flux with respect to the mesh size: the previous figure 5 corresponding to the finest mesh. The flux decreases towards its limit. The convergence rate is evaluated by computing the ratio $(\phi_{n-2} - \phi_{n-1})/(\phi_{n-1} - \phi_n)$ with ϕ_n the computed flux on the n^{th} mesh. The reported figure suggest an order one convergence of the flux with h . With such an assumption, the relative error on the flux induced by the discretisation may be of 1% for the finest mesh.

5.4. Counter current case. We finally consider the last configuration: the counter current one for which the total debit $Q = 0$: it is depicted on the right side of figure 1 and consists of two parallel circular ducts where a fluid is flowing in opposite directions. The two ducts are encapsulated inside a cylindrical solid. On figure 6 is displayed the evaluation of the fluid/solid exchange flux on both left and right pipe boundaries. We adopt an infinite configuration where the outer solid wall is heated for $z < 0$ and verifies a zero flux condition for $z > 0$ (as described in corollary 3.7). We concentrate on the heat flux on the two internal duct boundaries for $z > 0$. The roles of the two ducts is absolutely non symmetric. The fluid in the left tube flows towards the $z > 0$ region. This fluid is heated in the $z < 0$ region by heat diffusion process in the solid. It then brings heat by convection to the $z > 0$ region: then this tube can be considered as the input duct. On the contrary the fluid in the right tube flows towards the $z < 0$ region and it evacuates heat by convection from the $z > 0$ region: it can be considered as the output duct. This means that the exchange flux is different in the left and in the the right tubes as can be observed in the left and right side of figure 6. It is also interesting to mention that the convergence

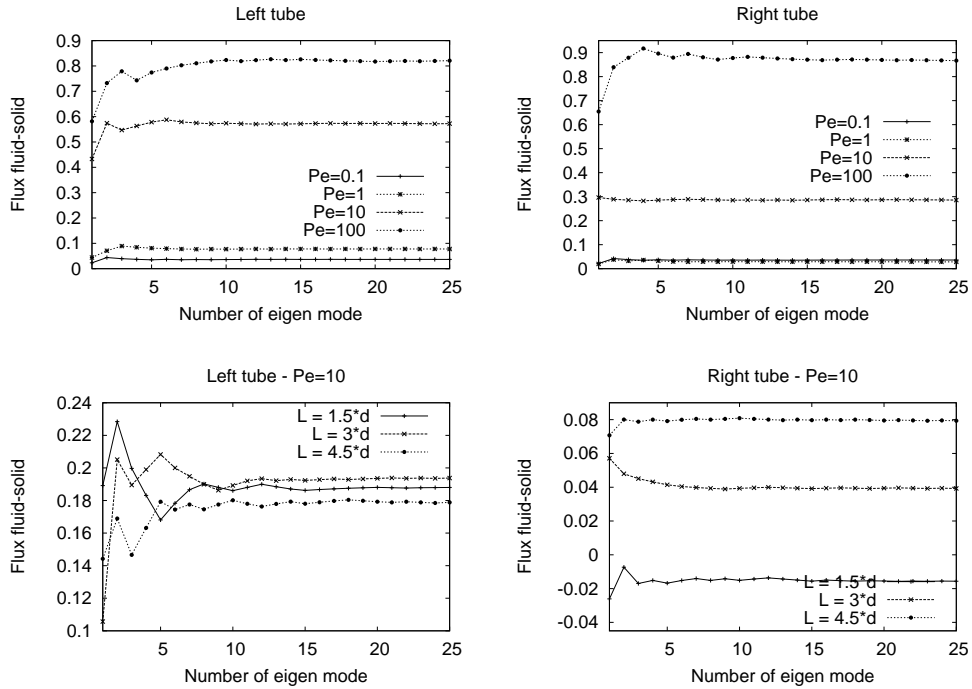

FIGURE 6. Counter current configuration. Fluid/solid heat exchange on the left and right duct boundaries. This flux is computed with an increasing number N of eigen modes, the dependence of the computed flux with N is here depicted for various values of the Péclet number (above), and for a varying distance L between the two pipes (below).

rate of the flux according to the number of considered eigenmodes is sensitive to the chosen geometrical parameters as well as to the Péclet number. Qualitatively the closer the tubes, the faster mode truncation converges to the exchange flux. On the other hand, increasing the Péclet number provides a slower mode convergence as observed on the upper part of figure 6. Nevertheless, an estimate of the exchange flux accurate within few percent is obtained in every configurations when aggregating the contribution of less than ten modes.

Another interesting observation is provided on figure 7 where one can observe the spatial structure of the most contributing modes to the exchange flux. As for figure 5, it can be observed that the spatial structure of the modes increases in complexity as their contribution to the exchange flux decreases. For example, the first mode is mostly of zeroth azimuthal order, the second and third modes are of first azimuthal order, the fourth to six modes are principally of azimuthal order three, etc... Nevertheless this observation is not a golden rule since the seventh mode has a azimuthal order one, with an horizontal symmetry as opposed to the second mode which also has a first azimuthal order but with a vertical symmetry. This observation indicates that the chosen configurations favours some symmetries for which the exchange is most favourable.

5.5. Conclusion. This work has permitted to extend the two-dimensional mapping of longitudinally invariant convection/diffusion problems to very general configurations with either prescribed field or fluxes at the outer boundary. In the case of

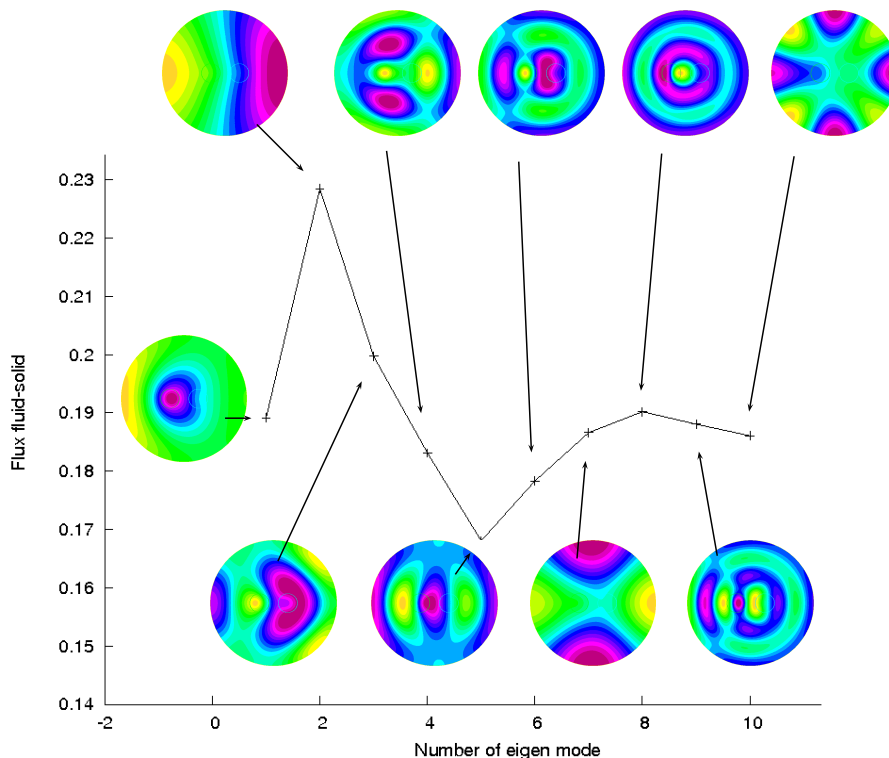

FIGURE 7. Flux convergence for the counter current configuration depicted figure 1-right, with parameters $Pe=10$, $D = 1$, $d = 0.3$ and $l = 0.45$. The Fluid-solid flux on the left tube boundary is computed for $z > 0$ with the ten first eigenmodes and their visualisations.

prescribed fluxes, it is necessary to distinguish the case of zero total convective flux (typically encountered in counter-current configurations) from the case of non-zero convective flux. In both cases, we found general analytical expression for the longitudinal variation of the solution, which depends on the applied boundary condition. Those considerations apply to convective exchangers and have been illustrated in some non-trivial configuration to illustrate the versatility and the numerical efficiency of the method for studying complex configurations. This analysis opens new perspective for a systematic and accurate study of convective exchangers and towards their optimisation.

Acknowledgments. The authors thank Jérôme Ferhenbach and Frédéric De Gournay for very fruitful discussions. They led us to a deeper understanding of the physics and of the mathematical properties of the problem, as well as to an efficient implementation to obtain the numerical results. The authors are indebted to Frédéric De Gournay for insinghful mathematical remarks concerning the extension of the compactness properties.

REFERENCES

- [1] Xing Chen, Da Fu Cui, Chang Chun Liu, and Hui Li. Microfluidic chip for blood cell separation and collection based on crossflow filtration. *Sensors and Actuators B: Chemical*, 2008.
- [2] J. Fehrenbach, F. De Gournay, C. Pierre, and F. Plouraboué. The Generalized Graetz problem in finite domains. *SIAM Appl. Math.*, Accepted manuscript, 2011.

- [3] L. Graetz. Über die Wärmeleitungsfähigkeit von Flüssigkeiten. *Annalen der Physik*, 261,(7):337–357, 1885.
- [4] F. Hecht, A. Le Hyaric, and O. Pironneau. <http://www.freefem.org/ff++/>.
- [5] C-D. Ho, H-M. Yeh, and W-Y. Yang. Improvement in performance on laminar counterflow concentric circular heat exchangers with external refluxes. *Int. J. Heat and Mass Transfer*, 45(17):3559–3569, 2002.
- [6] C.D. Ho, H.M. Yeh, and W.Y. Yang. Double-pass Flow Heat Transfer In A Circular Conduit By Inserting A Concentric Tube For Improved Performance. *Chem. Eng. Comm.*, 192(2):237–255, 2005.
- [7] S. P. Mahulikar and C. P. Tso. A new classification for thermal development of fluid flow in a circular tube under laminar forced convection. *Proc. R. Soc. Lond. A*, 458:669–682, 2002.
- [8] W. Nusselt. Die abhängigkeit der wärmeübergangszahl von der rohrlänge. *Z. Ver. Deut. Ing.*, 54:1154–1158, 1910.
- [9] E. Papoutsakis, D. Ramkrishna, and H-C. Lim. The extended Graetz problem with Dirichlet wall boundary conditions. *Appl. Sci. Res.*, 36:13–34, 1980.
- [10] C. Pierre and F. Plouraboué. Numerical analysis of a new mixed formulation for eigenvalue convection-diffusion problems. *SIAM J. Appl. Math.*, 70(3):658–676, 2009.
- [11] C. Pierre, F. Plouraboué, and M. Quintard. Convergence of the generalized volume averaging method on a convection-diffusion problem: a spectral perspective. *SIAM J. Appl. Math.*, 66(1):122–152, 2005.
- [12] Dušan P. Sekulić R. K. Shah. *Fundamentals of heat exchanger design*. John Wiley and Sons, Ne Jersey, 2003.
- [13] M. Reed and B. Simon. *Methods of modern mathematical physics. I. Functional Analysis*. Academic Press, New York, 1975.
- [14] M. Reed and B. Simon. *Methods of modern mathematical physics. II. Fourier analysis, self-adjointness*. Academic Press, New York, 1975.
- [15] R.K. Shah and A.L. London. *Laminar Flow Forced Convection in Ducts*. Academic Press Inc., New York, 1978.
- [16] A.S. Telles, E.M. Queiroz, and G.E. Filho. Solutions of the extended Graetz problem. *Int. J. Heat Mass Transfer*, 44(2):471–483, 2001.
- [17] B. Weigand and G. Gassner. The effect of wall conduction for the extended Graetz problem for laminar and turbulent channel flows. *Int. J. Heat Mass Transfer*, 50(5-6):1097–1105, 2007.
- [18] B. Weigand and F. Wrona. The extended Graetz problem with piecewise constant wall heat flux for laminar and turbulent flows inside concentric. *Heat and Mass Transfer*, 39(4):1432–1181, 2003.

(Julien Bouyssier)

UNIVERSITÉ DE TOULOUSE, INPT, UPS, IMFT (INSTITUT DE MÉCANIQUE DES FLUIDES DE TOULOUSE), ALLÉS CAMILLE SOULA, F-31400 TOULOUSE, FRANCE, AND CNRS, IMFT, F-31400 TOULOUSE, FRANCE.

E-mail address: jbouyssi@imft.fr

(Charles Pierre)

LABORATOIRE DE MATHÉMATIQUES ET APPLICATIONS
UNIVERSITÉ DE PAU ET DU PAYS DE L'ADOUR
AV. DE L'UNIVERSITÉ BP 1155
64013 PAU CEDEX - FRANCE

E-mail address: charles.pierre@univ-pau.fr

(Franck. Plouraboué)

UNIVERSITÉ DE TOULOUSE, INPT, UPS, IMFT (INSTITUT DE MÉCANIQUE DES FLUIDES DE TOULOUSE), ALLÉS CAMILLE SOULA, F-31400 TOULOUSE, FRANCE, AND CNRS, IMFT, F-31400 TOULOUSE, FRANCE.

E-mail address: fplourab@imft.fr