



HAL
open science

An Approach to Integrate Production-Transportation Planning and Scheduling in an Aluminium Supply Chain Network

Martin Steinrücke

► **To cite this version:**

Martin Steinrücke. An Approach to Integrate Production-Transportation Planning and Scheduling in an Aluminium Supply Chain Network. *International Journal of Production Research*, 2011, pp.1. 10.1080/00207543.2010.528461 . hal-00666670

HAL Id: hal-00666670

<https://hal.science/hal-00666670>

Submitted on 6 Feb 2012

HAL is a multi-disciplinary open access archive for the deposit and dissemination of scientific research documents, whether they are published or not. The documents may come from teaching and research institutions in France or abroad, or from public or private research centers.

L'archive ouverte pluridisciplinaire **HAL**, est destinée au dépôt et à la diffusion de documents scientifiques de niveau recherche, publiés ou non, émanant des établissements d'enseignement et de recherche français ou étrangers, des laboratoires publics ou privés.



**An Approach to Integrate Production-Transportation
Planning and Scheduling in an Aluminium Supply Chain
Network**

Journal:	<i>International Journal of Production Research</i>
Manuscript ID:	TPRS-2010-IJPR-0697.R1
Manuscript Type:	Original Manuscript
Date Submitted by the Author:	22-Aug-2010
Complete List of Authors:	Steinrücke, Martin; Ernst-Moritz-Arndt-Universität Greifswald, Department of Law and Economics
Keywords:	HEURISTICS, MIXED INTEGER LINEAR PROGRAMMING, LOGISTICS, MATERIAL FLOW, MATH PROGRAMMING, OPTIMIZATION, NETWORKS, QUANTITATIVE MODELS, SCHEDULING, SUPPLY CHAIN MANAGEMENT
Keywords (user):	

SCHOLARONE™
Manuscripts

An Approach to Integrate Production-Transportation Planning and Scheduling in an Aluminium Supply Chain Network

Martin Steinrücke¹

Department of Law and Economics, Ernst-Moritz-Arndt-Universität Greifswald, Friedrich-Loeffler-
Straße 70, 17489 Greifswald, Germany

Abstract

This paper is based on a real-life problem of a global aluminium supply chain network driven by an aluminium smelter. At each echelon of the aluminium supply chain network several members are involved which are scattered around the world. Producing aluminium begins with bauxite mining. Next, aluminium oxide is made from bauxite and finally aluminium is produced from aluminium oxide. A novel type of mixed-integer decision-making model, including a time-continuous representation of the planning period, is presented. The model enables coordination of production quantities and times of all supply chain members in order to minimise production and transportation costs of the whole supply chain minus bonus payments for early deliveries which are stipulated between the supply chain network and its customers. Material flows can take place with or without temporary storage of intermediate products at supplying and/or receiving sites. Furthermore, relax-and-fix heuristics are presented. A number of randomly generated scenarios are presented to demonstrate that the heuristics can find nearly optimal solutions along with drastically reduced computation times. The relax-and-fix heuristic enables iterative planning between centralised and decentralised decision-makers.

Keywords: supply chain network, distribution, scheduling, mixed-integer programming, relax-and-fix heuristic

¹ Corresponding author, Email: steinruecke@gmx.net

1. Introduction

Growing competition in world markets has led to a situation in which entire supply chain networks compete with one another. A supply chain network consists of definable supply chain echelons, whereas each supply chain echelon can comprise several production sites scattered around the world which perform the same or at least homogenous processes. Production sites within the entire network, as well as shipping companies between supply chain echelons, cooperate. Supply chain partners are legally and economically independent. Therefore, collaboration must be based on contracts. Furthermore, transportation costs depend significantly on the amount of material flows between geographically distant production sites. The competitiveness of a supply chain network depends mainly on its ability to coordinate production operations and material flows throughout the supply chain network. Thereby, specific requirements that arise from collaborations must be considered. These can include agreements on bonus payments. Frequently, final customers grant bonus payments for early deliveries before a stipulated delivery deadline. These can be formulated in different ways. For example, bonus payments can be measured according to whether an order quantity is supplied in full or partially before a stipulated delivery dead line. Next to this, other arrangements for bonus payments are also possible. This paper focuses an aluminium supply chain network. Aluminium is mainly in demand by the aerospace, automobile and packaging industries. There are more than 200 aluminium smelters worldwide which are subject to increasing competition. Low costs for production, shipping and adherence to delivery schedules by and to all sites in the supply chain network along with fulfilling commitments to customers are key. As a result, not only aluminium smelters but also global production and shipping networks compete with one another. Aluminium production involves global production and shipping. Shipping costs are mainly influenced by the amount of material flows between distant production sites. A competitive edge can only be guaranteed by integrating sites throughout the supply chain network in different countries. A major task within the aluminium supply chain network is the integrated coordination of time schedules for medium-term planning horizons. These encompass for example 6 to 12 months. Whereas production-transportation planning in supply chain networks is frequently addressed, the combined production-transportation planning and time-scheduling problem is usually neglected. This paper is organised as follows. Section 2 describes the assumed aluminium supply chain network. Additionally, legal and economical and technological conditions for the

collaboration between supply chain partners and customers are treated. In Section 3, a novel mixed-integer decision model to coordinate production quantities and times as well as material flows throughout a supply chain network is presented. In Section 4, relax-and-fix heuristics are presented that correspond to planning opposite to the direction of material flow (upstream planning). Section 5 presents a performance test of the relax-and-fix heuristics for a number of randomly generated scenarios. The standards of comparison are the optimum objective function values and the corresponding computation times. Finally, Section 6 includes conclusions and recommendations for further research.

2. The aluminium supply chain network

2.1 Production processes and supply chain network structure

There are two different ways to obtain aluminium. The first one is to make aluminium from bauxite. In this case the obtained aluminium is denoted “primary aluminium”. Intermediate products are these products that are won or produced in all echelons except for the last one. They are required for production of finished products. Here, bauxite and aluminium oxide represent intermediate products. The second way to obtain aluminium is by recycling aluminium scrap. Then, the obtained aluminium is denoted “secondary aluminium”. For a description of both sources of aluminium and a discussion of the secondary aluminium production see Ferretti *et al.* 2007. In this paper we focus on the production of primary aluminium as this is the original source of aluminium and the basis for the supply chain network. The aluminium supply chain network is characterized by three production processes (Figure 1). First, the raw material bauxite is mined, whereas mining can be conducted above and below the surface. But, in most cases it is mined above the surface. Then, aluminium oxide is won from bauxite. For this purpose a specific process is applied, termed Bayer Process. Finally, by applying the so-called Hall-Héroult Process aluminium is won from aluminium oxide. Here, we assume that one metric ton (= 1,000 kg) of aluminium oxide is won from two metric tons of bauxite and 1.875 metric tons of aluminium oxide are required to produce one metric ton of aluminium. A detailed description of the three production processes is attached in the Appendix. These are conducted at different sites which are scattered around the world. As a consequence, bauxite and aluminium oxide are mostly shipped overseas. This means intercontinental shipments for example between Africa and Europe. Next to overseas shipments there can also occur domestic shipments within a country or continent. For shipments to aluminium oxide refineries and aluminium

1
2 smelters large bulk carriers are used. In 2008, bauxite was mined globally in 29
3 countries and aluminium oxide was produced in 28 countries. Aluminium oxide was
4 shipped to more than 200 aluminium smelters in 46 countries and processed into
5 aluminium (Brown *et al.* 2010). The customer of the aluminium supply chain network is
6 an aluminium casting plant (final customer) which is supplied by truck.
7
8
9
10
11

12
13
14
15 **Figure 1**
16
17
18
19
20
21

22
23 In this paper we assume an aluminium supply chain network that consists of one
24 aluminium smelter, several aluminium oxide refineries and bauxite mines (Figure 2).
25 The aluminium smelter is located in Germany and receives aluminium oxide from
26 production sites in Ireland, Italy, Jamaica and Spain which, for their part, are supplied
27 by bauxite mines in Australia, Jamaica and West Africa. The aluminium smelter is the
28 initiator of all planning activities. He faces given final customer demand from an
29 aluminium casting plant. The production processes lead to a multi-echelon perspective
30 of the aluminium supply chain network in which sites producing the same output form a
31 definable group which we will call a supply chain stage (SC stage).
32
33
34
35
36
37
38
39
40

41
42 **Figure 2**
43
44
45
46
47
48
49
50

51 *2.2 Principles of collaboration*

52 The three-echelon collaboration among independent supply chain members (aluminium
53 smelter, aluminium oxide refineries, bauxite mines and one shipping company) is based
54 on agreements. Company information is confidential. So, data is assumed as follows.
55
56

57 (1) Stipulations between the aluminium smelter and the final customer:

58 The final customer's order quantity is 96,000 metric tons of aluminium. These 96,000
59 metric tons must be delivered within 6 months from the planning time point forward.
60 The final customer grants bonus payments for early deliveries. Bonus payments are

1
2 arranged as follows. For each day of early delivery before expiration of the 6 months a
3 five-figure bonus payment is granted. Hence, bonus payments are based on the
4 difference between the delivery deadline (6 months) and the actual delivery date. This
5 arrangement also applies to partial deliveries if these do not fall below a minimum
6 delivery quantity of 8,000 metric tons. In total maximally four partial shipments are
7 accepted which must sum up to 96,000 metric tons of aluminium. Here, bonus payments
8 of 50,000 US\$ per day of early delivery are assumed. The aluminium smelter
9 guarantees a local supply which means that the final customer fetches the products at
10 the aluminium smelter.
11
12
13
14
15
16
17

18
19
20 (2) Stipulations among the sites in the supply chain and the shipping company:
21

22 To produce 96,000 metric tons of aluminium, 180,000 metric tons of aluminium oxide
23 and 360,000 metric tons of bauxite are required. Distribution decisions must be made
24 among the sites including which sites are responsible for which amounts of bauxite and
25 aluminium oxide, i.e., how to split up the required amounts of bauxite and aluminium
26 oxide among the sites. Furthermore, the aluminium smelter must decide which amounts
27 of aluminium are to be produced on which of his four production lines. Then,
28 production decisions must be made. This includes which production quantities are
29 produced in which sites. A production quantity is defined as the amount of intermediate
30 products (bauxite and aluminium oxide) and final products (aluminium) each site
31 produces. A special case would be that one site within a SC stage produces the required
32 amount of an intermediate product in full in a single production quantity. For example,
33 this would be the case when a single mine must supply the whole 360,000 metric tons of
34 bauxite or a single aluminium oxide refinery would have to supply the whole 180,000
35 metric tons of aluminium oxide. Certainly, this is only a theoretical case. Therefore, the
36 entire SC stages, including their corresponding sites, have to supply the required
37 amounts of intermediate products. Additionally, the following data have to be taken into
38 account within the production decisions. Each production site claims a minimum
39 production quantity which is the lower bound for collaboration. Based on the sites'
40 individual situations production quantities can be produced in several smaller
41 production lots. However, sites emphasize that production processes are conducted as
42 closed-end as possible. For this reason they also claim that a production quantity is
43 produced in a maximum number of production lots. Furthermore, each production lot
44 must have a minimum size.
45
46
47
48
49
50
51
52
53
54
55
56
57
58
59
60

Tables 1 and 2

Clearly, minimum production lot sizes as well as the maximum number of production lots can have a restrictive impact. In the following the specific situation of the bauxite mine in Jamaica is briefly elucidated (Table 1). Decisions on production quantities must be made and are unknown prior to the model computation. If a production quantity is assigned between 25,000 and 39,999 metric tons, then this production quantity must be produced in one production lot. This results from the fact that producing in two production lots would violate the restriction of minimum production lot sizes. If a production quantity of 40,000 metric tons or more is assigned, then one or two production lots are feasible. For example, a production quantity of 60,000 metric tons could be produced in two production lots of 35,000 and 25,000 metric tons, but not in two lots in the amounts of 41,000 and 19,000 metric tons. Likewise, three production lots in the amount of 20,000 metric tons are feasible with respect to the minimum size of production lots, but infeasible due to the maximum number of production lots.

(3) Stipulations among the sites concerning time scheduling:

Sites stipulate in-time supply of one another which means that each site must be supplied at its production start at the latest. In consequence, in-time supply lead to material flows with or without temporary storage of intermediate products at supplying and/or receiving sites. Therefore, sites' production start times must be coordinated within the supply chain network. For this purpose production speeds as well as shipping times are required. Table 3 depicts the assumed sites' production speeds in metric tons per day. Every site in the supply chain network uses a single production line. Production lots must therefore be produced consecutively. In contrast, the production operations of the aluminium smelter can occur simultaneously on four independent, parallel production lines. Production speeds vary between the different sites. This is explained by the usage of different technologies and resources which differ in their capacities.

Tables 3 and 4

Panamax bulk carriers are used to ship bauxite overseas. These are universal bulk carriers whose loading capacity lies between 60,000 and 80,000 dead weight tons (dwt). Here, the loading capacity of used Panamax bulk carriers is 70,000 metric tons.² At least 10,000 metric tons of bauxite must be shipped in one single shipment. In contrast, bauxite at the Jamaica site is shipped by train to an aluminium oxide refinery 18 kilometres away. At the next shipping stage, the aluminium oxide is shipped to Rotterdam on Handymax bulk carriers (loading capacity: 40,000 to 60,000 dwt). It is then reloaded to so-called lighters (large, flat-bottom barges) and shipped on the Rhine and the Rhine-Herne Canal to the aluminium smelter's own unloading dock in the inland harbour (Weerts 2008). The shipping company has agreed to reserve 25,000 metric tons of transport volume on the Handymax bulk carriers. The minimum shipping quantity for each shipment is 5,000 metric tons. The shipping capacities of lighters are assumed to be unlimited. In Table 5 the assumed variable production costs and the shipping costs are compiled. Each site has different variable and fixed costs. For example, bauxite mining costs depend on the method of mining, i.e. above-ground or underground. Electricity costs for aluminium oxide production, which is rather energy intensive, depend on site-specific sources of energy. Shipping costs depend on distances, transportation modes and shipping times between the sites.

Table 5

The goal of the aluminium supply chain is to meet the required final customer's order quantity at minimum production and shipping costs minus bonus payments for early

² Dead weight tons (dwt) is the description of the loading capacity of cargo ships whereas freights are measured in metric tons. One metric ton equals to one dead weight ton (see Bilgen and Ozkarahan 2007, p. 557; Stopford 2009, p. 424).

deliveries. The decisions can be outlined as follows. 96,000 metric tons of aluminium are to be allocated to the aluminium smelter's four production lines. 180,000 metric tons of aluminium oxide and 360,000 metric tons of bauxite must be assigned to the corresponding sites depicted in Figure 2. Furthermore, each site must decide in which production lot each assigned production quantity is split up. Moreover, it must be determined which sites are supplied by which preceding sites and in what volume. In addition, production start and end times of all sites' production lots must be coordinated to ensure in-time supply within the supply chain network.

3. Modelling a supply chain network

3.1 Problem description and assumptions

3.1.1 Supply chain network characteristics

Let $I_S = \{1, 2, \dots, N\}$ be the set of SC stages to be coordinated and Γ_σ be the set of production sites at SC stage $\sigma \in I_S$ (Figure 3). Collaboration between independent production sites $i \in \Gamma_\sigma$, $\sigma \in I_S$, and logistic companies, responsible for transporting intermediate products between production sites $i \in \Gamma_\sigma$, $\sigma \in I_S$, and $j \in \Gamma_{\sigma+1}$, $\sigma+1 \in I_S$, can be regulated through contracts, participations or bargaining power (Chen *et al.* 2007). Overall harmony depends on developing win-win situations and accounting for the interests of individual contractual parties during the central decision-making process.

Figure 3

3.1.2 Exogenous conditions

Production and transportation activities within a supply chain network are initiated through final customer's order quantity B produced in SC stage N . Then, the production amounts of the preceding SC stages as well as the material flows between directly succeeding SC stages are given, based on input-output relations $a_{\sigma, \sigma+1}$ between the SC stages $\sigma \in I_S$ and $\sigma+1 \in I_S$. Further, the latest acceptable delivery date T is defined as well. Final customer's order quantity B can be released in several partial deliveries.

These may not be less than a minimum delivery quantity ℓ_i , $i \in \Gamma_N$, defined by the final customer. For each day of early delivery of every single partial shipment before T, bonus payment b is awarded.

3.1.3 Site-specific data and situations

Variable unit costs $c_i^{\text{pr, var}}$ of the production sites $i \in \Gamma_\sigma$, $\sigma \in I_S$, usually depend on site-specific conditions, such as labour or energy-intensive production. Furthermore, fixed costs $c_i^{\text{pr, fix}}$ for engaging a production site may arise. Also, site-specific production rates λ_i are assumed. The mostly legally independent production sites are insofar part of a supply chain network as their production capacities are available only under certain conditions. For example they can claim minimum production quantities x_i^{min} or maximum capacities x_i^{max} . Besides, it is possible to decide decentrally into which minimum production lot sizes ℓ_i the total production quantity of a site is divided. Let L_i be the set of production lots, then up to $|L_i|$ production lots are possible. Moreover, whether the production lots can be produced only consecutively or whether production operations can take place at the same time needs to be considered. Thus, let $\Gamma_\sigma^{\text{kon}}$, $\sigma \in I_S$, be the set of production sites in SC stage $\sigma \in I_S$ that need to manufacture production lots consecutively ($\Gamma_\sigma^{\text{kon}} \subseteq \Gamma_\sigma$).

3.1.4 Transportation parameters

Variable and/or fixed transportation costs may arise during transport between SC stages. Time charter means that shipping rates are calculated in US\$ per time unit. Taking into account transportation times τ_{ij} between production sites $i \in \Gamma_\sigma$, $\sigma \in I_S$, and $j \in \Gamma_{\sigma+1}$, $\sigma+1 \in I_S$, fixed transportation cost rates $c_{ij}^{\text{tr, fix}}$ result. In contrast, voyage charter is calculated in US\$ per metric ton of cargo (Stopford 2009, p. 176). This corresponds to variable transportation cost rates $c_{ij}^{\text{tr, var}}$. Minimum shipping quantities $q_{\sigma, \sigma+1}^{\text{min}}$ can be stipulated. Bulk carriers of different maximum load capacities $q_{\sigma, \sigma+1}^{\text{max}}$ are used in overseas shipping (Bilgen and Ozkarahan 2007).

3.1.5 Supply chain objectives and decisions

The entire supply chain network aims to minimise production and transportation costs less bonus payments for early deliveries. The following decisions are thus made for the multi-stage production-shipping and distribution-scheduling problem including in-time supplies of all production sites [MSPSDS-IS] (Figure 4).

Figure 4

- (1) As mentioned in Section 3.1.2, the production amounts at every SC stage are given for a final customer's order quantity B . Therefore, at each SC stage, the decision is made on how to divide production amounts among the sites. As a result, each site is allotted a production quantity $x_i, i \in \Gamma_\sigma, \sigma \in I_S$.
- (2) Each site's production quantity x_i is produced in one or more production lots. Hence, the decision to split up site production quantities into production lots has to be made. In the following text, p_{ik} is denoted as the k -th production lot, $k \in L_i$, at site $i \in \Gamma_\sigma, \sigma \in I_S$. Potentially, production lots are passed to several sites in the following stage.
- (3) The decision is made about into how many transportation lots of which size each production lot p_{ik} is divided into. It is assumed that each transportation lot is supplied to just one production lot of only one following site. Let q_{ijkm} be the quantity of intermediate products taken from the k -th production lot, $k \in L_i$, at site $i \in \Gamma_\sigma, \sigma \in I_S$, which is fed into the m -th production lot, $m \in L_j$, at site $j \in \Gamma_{\sigma+1}, \sigma+1 \in I_S$. The overall result specifies which of the potential material flows outlined in Figure 4 are carried out. The amount of material flow between the SC stages is given. In contrast, material flows between the directly succeeding sites must be decided. Therefore, the distinction must be made between given material flows to be transported between directly succeeding SC stages on the one hand (Figure 3) and potential material flows transported between sites in directly succeeding SC stages

on the other hand (Figures 4).

- (4) Production start and end times of all production lots, as well as transportation start and end times of all transportation lots, are coordinated to ensure in-time supplies of the required intermediate product amounts. Thus, both stock-free material flows and temporary storage between supplying and receiving sites are possible. Here, t_{ik} denotes the production start time of the k -th production lot, $k \in L_i$, at site $i \in \Gamma_\sigma$, $\sigma \in I_S$. Whether production lots need to be produced consecutively or time overlaps in production are possible is taken into consideration. For instance, production operations with time overlaps is the case if a company can produce on multiple independently operating lines.

3.2 The MSPSDS-IS planning model

Due to the structure of the problem, time-continuous modelling is preferred to a discretization of the planning period. Discrete modelling can be found for example in Almeder *et al.* 2009, Ouhimmou *et al.* 2008, Tang and Liu 2007 and van Hoesel *et al.* 2005. In addition to the data and continuous decision variables introduced in Section 3.1, the following binary variables are introduced:

- a_{ik} 1, if the k -th production lot, $k \in L_i$, at site $i \in \Gamma_\sigma$, $\sigma \in I_S$, is produced and 0 otherwise;
- b_{ijkm} 1, if intermediate products of the k -th production lot, $k \in L_i$, at site $i \in \Gamma_\sigma$, $\sigma \in I_S$, are fed into the m -th production lot, $m \in L_j$, at site $j \in \Gamma_{\sigma+1}$, $\sigma+1 \in I_S$, and 0 otherwise (remark: b_{ijkm} quantifies transportation lots);
- y_{ijkm} 1, if production of the k -th production lot, $k \in L_i$, at site $i \in \Gamma_\sigma$, $\sigma \in I_S$, is finished at production start of the m -th production lot, $m \in L_j$, at site $j \in \Gamma_{\sigma+1}$, $\sigma+1 \in I_S$, at the latest and 0 otherwise;
- ω_i 1, if site $i \in \Gamma_\sigma$, $\sigma \in I_S$, is engaged by the supply chain and 0 otherwise.

The multi-stage production-shipping and distribution-scheduling model including in-time supplies of all production sites [MSPSDS-IS] is formulated as follows:

$$\begin{aligned}
\min Z = & \underbrace{\sum_{\sigma \in I_s} \sum_{i \in \Gamma_\sigma} c_i^{\text{pr,var}} \cdot x_i + c_i^{\text{pr,fix}} \cdot \omega_i}_{\text{production costs}} \\
& + \underbrace{\sum_{\sigma=1}^{N-1} \sum_{i \in \Gamma_\sigma} \sum_{j \in \Gamma_{\sigma+1}} \sum_{k \in L_i} \sum_{m \in L_j} c_{ij}^{\text{tr,fix}} \cdot b_{ijkm} + c_{ij}^{\text{tr,var}} \cdot q_{ijkm}}_{\text{transportation costs}} \\
& - b \cdot \underbrace{\left(\sum_{i \in \Gamma_N} \sum_{k \in L_i} T - t_{ik} - \frac{p_{ik}}{\lambda_i} \right)}_{\text{bonus payments}} \quad (1)
\end{aligned}$$

s.t.

$$\sum_{i \in \Gamma_N} x_i = B \quad (2)$$

$$\sum_{i \in \Gamma_\sigma} x_i = a_{\sigma,\sigma+1} \cdot \left(\sum_{j \in \Gamma_{\sigma+1}} x_j \right), \quad \sigma=1, \dots, N-1 \quad (3)$$

$$x_i = \sum_{k \in L_i} p_{ik}, \quad i \in \Gamma_\sigma, \quad \sigma \in I_s \quad (4)$$

$$p_{ik} = \sum_{j \in \Gamma_{\sigma+1}} \sum_{m \in L_j} q_{ijkm}, \quad i \in \Gamma_\sigma, \quad k \in L_i, \quad \sigma=1, \dots, N-1 \quad (5)$$

$$a_{\sigma,\sigma+1} \cdot p_{jm} = \sum_{i \in \Gamma_\sigma} \sum_{k \in L_i} q_{ijkm}, \quad j \in \Gamma_{\sigma+1}, \quad m \in L_j, \quad \sigma=1, \dots, N-1 \quad (6)$$

$$x_i^{\min} \cdot \omega_i \leq x_i, \quad x_i \leq x_i^{\max} \cdot \omega_i, \quad i \in \Gamma_\sigma, \quad \sigma \in I_s \quad (7)$$

$$\ell_i \cdot a_{ik} \leq p_{ik}, \quad p_{ik} \leq x_i^{\max} \cdot a_{ik}, \quad i \in \Gamma_\sigma, \quad k \in L_i, \quad \sigma \in I_s \quad (8)$$

$$q_{\sigma,\sigma+1}^{\min} \cdot b_{ijkm} \leq q_{ijkm}, \quad q_{ijkm} \leq q_{\sigma,\sigma+1}^{\max} \cdot b_{ijkm},$$

$$(i, j) \in \Gamma_\sigma \times \Gamma_{\sigma+1}, \quad (k, m) \in L_i \times L_j, \quad \sigma=1, \dots, N-1 \quad (9)$$

$$t_{ik} + \frac{p_{ik}}{\lambda_i} + \tau_{ij} \cdot b_{ijkm} \leq t_{jm} + C \cdot (1 - y_{ijkm}), \quad t_{ik} + \frac{p_{ik}}{\lambda_i} > t_{jm} - C \cdot y_{ijkm},$$

$$(i, j) \in \Gamma_{\sigma} \times \Gamma_{\sigma+1}, (k, m) \in L_i \times L_j, \sigma=1, \dots, N-1 \quad (10)$$

$$b_{ijkm} \leq y_{ijkm}, (i, j) \in \Gamma_{\sigma} \times \Gamma_{\sigma+1}, (k, m) \in L_i \times L_j, \sigma=1, \dots, N-1 \quad (11)$$

$$t_{ik} + \frac{p_{ik}}{\lambda_i} \leq t_{i,k+1}, i \in \Gamma_{\sigma}^{\text{kon}}, k, k+1 \in L_i, \sigma \in I_S \quad (12)$$

$$t_{ik} + \frac{p_{ik}}{\lambda_i} \leq T, i \in \Gamma_N, k \in L_i \quad (13)$$

$$t_{ik} \leq T + C \cdot a_{ik}, t_{ik} \geq T - C \cdot a_{ik}, i \in \Gamma_N, k \in L_i \quad (14)$$

$$\omega_i \in \{0, 1\}, i \in \Gamma_{\sigma}, \sigma \in I_S \quad (15)$$

$$a_{ik} \in \{0, 1\}, i \in \Gamma_{\sigma}, k \in L_i, \sigma \in I_S \quad (16)$$

$$b_{ijkm} \in \{0, 1\}, (i, j) \in \Gamma_{\sigma} \times \Gamma_{\sigma+1}, (k, m) \in L_i \times L_j, \sigma=1, \dots, N-1 \quad (17)$$

$$y_{ijkm} \in \{0, 1\}, (i, j) \in \Gamma_{\sigma} \times \Gamma_{\sigma+1}, (k, m) \in L_i \times L_j, \sigma=1, \dots, N-1 \quad (18)$$

$$x_i \geq 0, i \in \Gamma_{\sigma}, \sigma \in I_S, p_{ik}, t_{ik} \geq 0, i \in \Gamma_{\sigma}, k \in L_i, \sigma \in I_S$$

$$q_{ijkm} \geq 0, (i, j) \in \Gamma_{\sigma} \times \Gamma_{\sigma+1}, (k, m) \in L_i \times L_j, \sigma=1, \dots, N-1 \quad (19)$$

1. Production and transportation distribution constraints

Constraint (2) ensures that final customer's order quantity B is produced in SC stage N and distributed to their sites. Constraints (3) ensure that through the input-output relations intermediate products required for the order quantity B are produced in the SC stages located upstream and then distributed to the sites. Constraints (4) model production distribution at the sites. Here, it is a matter of splitting up the production quantities at the sites into a maximum number of production lots. The production quantities can also be split up when there are fewer than the maximum number of production lots. Constraints (5) and (6) model the planning of transportation lots. Firstly, they ensure that production lots at the sites are passed on to the following SC stage by splitting them up into transportation lots. Secondly, they ensure that production lots of the receiving sites are supplied with the required intermediate products from the previous SC stage. Each transportation lot serves exactly one production lot at a

receiving site. However, each suppliers' production lot can serve more than one production lot at the next stage (Figure 4). Constraints (7) and (15) model the meaning of the corresponding 0/1-production variables. Only when site $i \in \Gamma_{\sigma}$, $\sigma \in I_S$, is in operation does the production quantity lie in the interval $[x_i^{\min}; x_i^{\max}]$, otherwise it is $x_i = 0$. If no minimum production quantity for site $i \in \Gamma_{\sigma}$, $\sigma \in I_S$ is stipulated, then the smallest calculable unit is used for x_i^{\min} . Constraints (8) and (16) or (9) and (17), respectively, model the meaning of the corresponding 0/1 production and 0/1 transportation variables. If minimum quantities of production or shipping lots are not contracted, then the smallest producible or transportable unit, respectively, is used.

2. Time constraints

Determining production and transportation lots subject to (2) – (9) and (15) – (17) while neglecting all other constraints is only in line with the objectives, when only production and transportation costs have to be considered. In this case, each scheduling exogenous to the model, which is executed supplementary to the endogenous distribution decisions [see Section 3.1.5, (1) – (3)] and which ensures in-time supply to all production sites, is in line with the objectives. This is based on production and transportation costs being invariant to time shifts in production and transportation lots. If, in addition, bonus payments for early delivery at the final customer need to be considered, then besides distribution decisions, production and transportation lot scheduling is also made endogenously to the model.

In this context, constraints (10) and (11) are of great importance. On the one hand, scheduling all production lots is coordinated so that all production sites receive intermediate products in time from the preceding SC stage. On the other hand, the constraints decouple the start times of production lots whenever there is no material flow between them. Only after the solution is known does it become obvious which production lots are supplied by which production lots in the preceding SC stage. Hence, restrictions for all possible combinations of production lot pairs, no matter where in directly succeeding SC stages, are thus modelled, resulting in the following cause and effect chain:

When there is no material flow between the k -th production lot at site $i \in \Gamma_{\sigma}$, $\sigma \in I_S$, and the m -th production lot at site $j \in \Gamma_{\sigma+1}$, $\sigma+1 \in I_S$, then $b_{ijkm} = 0$. Due to (11) and (18),

$y_{ijkm} \in \{0,1\}$ results. Thus, including a large enough number C , it is $t_{ik} + p_{ik} \cdot \lambda_i^{-1} \leq t_{jm}$
 or $t_{ik} + p_{ik} \cdot \lambda_i^{-1} > t_{jm}$ [see (10)]. This means that both production lots are scheduled
 independently of one another. If, however, a material flow does take place, then $b_{ijkm} =$
 1. From (11) and (18) $y_{ijkm} = 1$ follows and in connection with (10)
 $t_{ik} + p_{ik} \cdot \lambda_i^{-1} + \tau_{ij} \leq t_{jm}$ results. The production lots are therefore scheduled so that the
 intermediate products arrive by production start time at the latest. Hence, stock-free
 material flows as well as temporary storage of intermediate products can occur.
 Furthermore, material flows between time overlapping productions are avoided. In this
 case, it is $y_{ijkm} = 0$ [see (10)], so that from (11), $b_{ijkm} = 0$ follows.

Constraints (12) ensure that the k -th production lot is scheduled before the $(k+1)$ -th
 production lot. This applies only to sites that must produce consecutively. Constraints
 (13) ensure that the production runs in SC stage N are completed by T at the latest.
 Constraints (14) record bonus payments. The decision model allows production of the
 final customer's order quantity B in less than the maximum number of production lots.
 In this case, $p_{ik} = 0$ and $t_{ik} \geq 0$ for at least one $i \in \Gamma_N$ and at least one $k \in L_i$. Then,
 constraints (14) avoid recording bonus payments for "completion" of non-production
 before delivery deadline T . The reason is $a_{ik} = 0$ results from $p_{ik} = 0$ and vice versa
 [see (8)]. Consequently, $t_{ik} = T$ is valid [see (14)]. In (1), therefore, bonus payments are
 ignored. Furthermore, constraints (14), including a large enough number C , do not
 restrict scheduling of the k -th production lot, $k \in L_i$, $i \in \Gamma_N$, when there is production
 ($a_{ik} = 1$).

3.3 Computation and explanation of an optimal solution

The details of collaboration in the supply chain network depicted in Figure 2 are treated
 as confidential. For this reason the data from Section 2 is assumed (see also Section C.1
 of the supplementary material).³ The corresponding MSPSDS-IS model consists of 269
 binary and 171 continuous variables and 726 restrictions. For restrictions (10) and (14),
 $C=10,000$ is defined. After nearly 199 hours of computation, the optimal solution,
 including total costs amounting to 174,807,600 US\$, was found (see Figure 5).

³ Supplementary material can be requested from the author.

Constraints (2) to (6) effect distribution in the aluminium supply chain. At each SC stage, the intermediate products required to produce 96,000 metric tons of aluminium are divided among the production sites. Not all production sites must be involved here. For example, at SC stage 2, only the production sites in Jamaica and Ireland are utilised. The sites' production quantities are split up into production lots and these are then further divided into transportation lots. However, it is not necessary to use up the maximum number of production and transportation lots. For example, the Ireland site produces only one production lot and splits that up into only two transportation lots. Material flows are coordinated so that all production lots are transported in full and the required intermediate products are supplied from the preceding SC stage. Moreover, constraints (10) and (11) coordinate the scheduling of production and transportation so that intermediate production quantities reach succeeding sites at their production start times at the latest. Intermediate products may be temporarily stored at the supplying and/or receiving production sites. Stock-free material flows may also take place. This situation is illustrated in Figure 5. It also demonstrates that despite the temporary storage of a number of transportation lots, shifting the last two production lots in SC stage 3 backward in time is not possible, even though it is preferable due to the bonus payments. Such a move cannot be made since time-overlapped production in SC stages 1 and 2 is not permissible. Restrictions (10) and (11) also prevent material flows if in-time supplies are not possible. For example, the first production lot of the Jamaica site in SC stage 2 cannot receive bauxite extracted in West Africa. On the one hand, it is not feasible because transportation requires 13 days and on the other hand, there is a time overlap with respect to the second production lot in the West Africa site.

Figure 5

4. Relax-and-fix heuristics to coordinate a three-stage supply chain network

All computations were carried out using the LINGO Hyper 11.0 (LINDO 2008) software optimisation package on an Intel Xeon Two Quad Core W5580 PC with 6.4 GT/s and 24 GB 1333 MHz ECC RDIMM memory. The computation times of the decision model MSPSDS-IS documented in Tables 6 to 9 show that determining

1
2 optimal solutions for practical instances is not a viable procedure. Therefore, relax-and-
3 fix heuristics (RF heuristics) are developed in order to find best possible solutions
4 within an acceptable computation time.
5

6
7 RF heuristics are based on a successive relaxation and fixing of binary variables
8 (Dillenberger *et al.* 1994). They solve several submodels of an original decision model
9 and mostly they lead to shorter computation times due to fewer binary variables. For
10 some applications, see Ferreira *et al.* (2009). Within the present problem RF heuristics
11 can be described as follows (Figure 6). The set of binary variables of the decision model
12 MSPSDS-IS is partitioned into disjoint subsets Q_j , $j=1, \dots, P$, in an initialization step 0.
13
14 Subsequent iterations proceed as follows. In step 1, binary variables of a subset are
15 calculated and binary variables of $P-1$ subsets are relaxed. In every following step
16 already calculated binary values of previous steps are fixed and remaining binary
17 variables are assumed to be continuous except for the binary variables of the subset to
18 be calculated in the current step (relaxing and/or fixing). In each step binary variables of
19 exactly one subset are calculated.
20
21

22
23 In principle, all input data must be chosen in such a way so that the decision model
24 MSPSDS-IS (including all binary variables) is feasible. Otherwise, a meaningful
25 solution procedure cannot be applied. Hence, the submodel in step 1 which results from
26 relaxing binary constraints in the decision model MSPSDS-IS is generally feasible, too.
27
28 However, a submodel in a subsequent step can be infeasible because fixing binary
29 variables from computations in previous steps constrains the feasible solution space of
30 the decision model MSPSDS-IS. In this case, Escudero and Salmeron (2005) propose to
31 stop the solution procedure.
32
33

34
35
36
37
38
39
40
41
42
43
44
45
46
47
48
49
50
51
52
53
54
55
56
57
58
59
60

Figure 6

In case that in a step i , $2 \leq i \leq P$, of the basic solution procedure of the RF heuristic a feasible solution cannot be found, at least one extended step becomes necessary. In each extended step one or more fixings from steps i , $2 \leq i \leq P$, are retracted. These extended solution procedure is stopped when a feasible solution is found. Generally, a feasible solution is found at the latest when all fixings are retracted because this implies solving a feasible submodel of the MSPSDS-IS. This is based on the fact that the MSPSDS-IS

for its part is assumed to be feasible. In the present case, a feasible solution is found when a small number of fixings is retracted.

Initialization: There are a number of ways to group the binary variables (15) to (18) of the MSPSDS-IS into disjoint subsets. The following partitions are analysed:

(a) Subsuming binary variables according to directly succeeding SC stages.

$$S_1 := \{ \omega_i, i \in \Gamma_1; a_{ik}, i \in \Gamma_1, k \in L_i; b_{ijkm}, y_{ijkm}, (i, j) \in \Gamma_1 \times \Gamma_2, (k, m) \in L_i \times L_j \}$$

$$S_2 := \{ \omega_i, i \in \Gamma_2 \cup \Gamma_3; a_{ik}, i \in \Gamma_2 \cup \Gamma_3, k \in L_i; b_{ijkm}, y_{ijkm}, (i, j) \in \Gamma_2 \times \Gamma_3,$$

$$(k, m) \in L_i \times L_j \}$$

(b) Activity-oriented subsuming of production binary variables and shipping binary variables. Shipping binary variables are partitioned whether they relate to transportations between SC stages 1 and 2 or transportations between SC stages 2 and 3.

$$S_3 := \{ \omega_i, i \in \Gamma_1 \cup \Gamma_2 \cup \Gamma_3; a_{ik}, i \in \Gamma_1 \cup \Gamma_2 \cup \Gamma_3, k \in L_i \},$$

$$S_4 := \{ b_{ijkm}, y_{ijkm}, (i, j) \in \Gamma_1 \times \Gamma_2, (k, m) \in L_i \times L_j \}$$

$$S_5 := \{ b_{ijkm}, y_{ijkm}, (i, j) \in \Gamma_2 \times \Gamma_3, (k, m) \in L_i \times L_j \}$$

Relaxing and/or Fixing: Partitioning according to (a) or (b) leads to either two or six possible sequences for relaxing/fixing binary variables. The resulting heuristics are termed as follows:

(a) RF heuristic $S_i S_j$: $Q_1 := S_j, Q_2 := S_i$ ($i, j \in \{1, 2\}, i \neq j$)

(b) RF heuristic $S_i S_j S_k$: $Q_1 := S_k, Q_2 := S_j, Q_3 := S_i$ ($i, j, k \in \{3, 4, 5\}, i \neq j, j \neq k, i \neq k$)

RF heuristics determine binary variables in steps 1 to P and continuous variables in step P. The continuous variables (and the optimum objective function values) calculated in steps 1 to P-1 remain unconsidered in following steps. Therefore, by determining binary variables it is stepwise planned which sites within the SC stages produce which production lots and in which transportation lots these are transferred to which sites in succeeding SC stages. In step P, determining continuous variables implies allocation of production and shipping quantities as well as production start times within the supply chain network.

5. Scenario analysis

5.1 Preliminary considerations

Production and shipping distribution as well as scheduling are connected within the MSPSDS-IS. Thus, data sets 1 to 4 (see supplementary material) are chosen randomly. Likewise, bonus payments b are varied isolated in the closed interval $[0;100,000]$ in steps of 10,000 US\$ (Tables 6 to 9). Therewith it is considered that scheduling impacts the objective function values only in case of bonus payments for early deliveries. Moreover, it is guaranteed that the MSPSDS-IS is feasible for data sets 1 to 4.

The question arises whether planning opposite to the direction of the material flows (upstream planning) or planning in the same direction as the material flows (downstream planning) is implemented. For the scenario analysis only RF heuristics for upstream planning are considered. These consistently result in better solutions than RF heuristics for downstream planning. The following RF heuristics are therefore considered.

S_1S_2 heuristic:

Step 1: Relax binary constraints of the variables in S_1 . Solve the resulting submodel of the MSPSDS-IS.

Step 2: Fix binary variables in S_2 generated at step 1. Solve the resulting submodel of the MSPSDS-IS.

$S_3S_4S_5$ heuristic:

Step 1: Relax binary constraints of the variables in S_3 and S_4 . Solve the resulting submodel of the MSPSDS-IS.

Step 2: Fix binary variables in S_5 generated at step 1. Relax binary constraints of the variables in S_3 . Solve the resulting submodel of the MSPSDS-IS.

Step 3: Fix binary variables in S_4 and S_5 generated at step 1 and 2. Solve the resulting submodel of the MSPSDS-IS.

The basic solution procedure of the RF heuristic is stopped if no feasible solution is found in steps 2 or 3 (Figure 6). Then, fixing of some binary transportation variables is retracted in an extended step. Binary transportation variables determine the structure of

material flows within the supply chain network and therefore constrain the solution space more than other binary variables. If still no feasible solution is found, additionally fixings of binary time structure variables are retracted in a further extended step.

5.2 Computational results

Objective function values found by RF heuristics S_1S_2 and $S_3S_4S_5$ differed from the optima less than 1% in most cases or even matched the optimum objective function values (scenarios 22, 32, 33, 43 and 44). Only in scenarios 12 to 15 and 31, deviations of 3% or more occurred with the heuristic $S_3S_4S_5$. At the same time, computation times could be reduced by more than 95% in nearly all scenarios. Computation times ranged from a few seconds to 2.5 hours (S_1S_2 , no. 34).

Increases in bonus payments tend to result in longer computation times (Tables 6 to 9). Scheduling must ensure in-time supplies of receiving sites within the network. In addition, the impact of scheduling on the objective function values intensifies with increasing bonus payments. Therefore, in contrast to cases without bonus payments, both must be taken into account, in-time supplies *and* intensifying influence on the objective function values.

The basic solution procedure of RF heuristic S_1S_2 did not find feasible solutions for 2 of the 44 scenarios. Furthermore, the basic solution procedure of RF heuristic $S_3S_4S_5$ did not find feasible solutions for 22 of the 44 scenarios. However, solutions close to the optima could be found with high reductions in computation times by applying maximally two extended steps (e.g. $S_3S_4S_5$, Tables 8 and 9).

In conclusion, applying RF heuristics S_1S_2 und $S_3S_4S_5$ is recommended due to high reductions in computation times and only slight deviations from the optima at the same time.

Tables 6 to 9

6. Conclusion and recommendations for future research

The origin of this paper is a real-life case of an aluminium supply chain network comprising three SC stages. Each SC stage is formed by several production sites located worldwide. The material flows between SC stages are conducted by a global shipping company. The production capacities as well as transportation capacities and cost structures vary from site to site. Total costs to coordinate production operations and material flows within the supply chain network are minimised. Production costs, transportation costs and bonus payments for early deliveries to final customers have to be taken into account. All supply chain partners are legally and economically independent and attach conditions to the collaboration. For example, considering a six-month planning horizon, the shipping company requires schedules on a daily basis including details such as which bulk carriers are (un-)loaded at which site and which amount of bauxite and aluminium oxide. Moreover, in-time supplies of all sites must be ensured. Thus, material flows without temporary storage of intermediate products as well as material flows including temporary storage are possible. The arising production and shipping problem requires a combination of planning and scheduling on a daily basis for all production and shipping activities within the network despite a medium-term planning horizon. Therefore, a time-continuous planning approach is presented. Production lots have to be jointly scheduled only when a material flow exists between them. However, production lots without connecting material flows between them are scheduled separately from each other. Nevertheless, only (optimal) solutions found by the decision model reveal whether two production lots are connected through material flows. This results from the fact that there are multiple production sites at each SC stage and, thus, there are alternative, but not necessarily used material flow paths, throughout the supply chain network. Hence, prior to quantity planning and scheduling, information must be taken into account which is unknown until the computation of the model. The intricate task of planning production quantities and start times simultaneously was solved by firstly integrating binary transportation variables in the system of distribution constraints and binary time structure variables in the system of time constraints. Secondly, these variables were related to each other by less-than-or-equal-to relations. Optimal solutions could not be calculated within acceptable computation times. Relax-and-fix heuristics were therefore developed and tested for a number of randomly generated scenarios. Relax-and-fix heuristics achieved feasible solutions close to the optimum while drastically reducing computation times at the same time.

1
2 Similar problem structures as outlined here can also be found in other industrial sectors.
3
4 Therefore, the presented mixed-integer decision model and relax-and-fix heuristics can
5 also be customised for supply chain networks in other industrial sectors. This refers to
6 the fact that production quantities must be allotted to multiple sites in SC stages as well
7 as productions and material flows between sites must be scheduled jointly. Besides the
8 aluminium supply chain network, this specifically applies to supply chains in the steel
9 and automotive industries. Time-continuous modelling notably suits for planning and
10 scheduling in global supply chain networks with third-party logistics which is the case
11 in commodity supply chain networks. Then, intercontinental shipments must be
12 scheduled on a daily basis several time periods in advance. Supply of intermediate
13 products within supply chain networks is only guaranteed when global production
14 activities can be coordinated exactly involving third-party logistics.
15
16
17
18
19
20
21
22

23
24 The necessity for further research arises from industry specific adaptations of the
25 decision model MSPSDS-IS. For example, several transportation modes between SC
26 stages including different transportation costs and transportation times could be
27 incorporated. Furthermore, several customers with individual product demands occurring
28 at different points of time could be considered.
29
30
31
32
33
34

35 **Appendix.** Primary aluminium production.

36
37
38 The production of primary aluminium is conducted in three steps.
39
40

- 41 (1) Bauxite mining
- 42
- 43 (2) Manufacturing of aluminium oxide applying the Bayer Process
- 44
- 45
- 46 (3) Production of aluminium applying the Hall-Héroult Process
- 47
- 48
- 49

50 In the first step bauxite is mined. This can take place above and below the surface.
51 Therefore, the future mining area must be prepared. By using specific tractors existing
52 woods are cleared and then removed with bulldozers. Bauxite generally lies under
53 several meters of silt. Then, the bauxite seam is loosened with dynamite. Bauxite is a
54 reddish ore which is the main natural resource for the aluminium fabrication. It is mined
55 with excavators and loaded on dump trucks. These reload the bauxite on conveyors
56 which carry it to harbours. After drying it is shipped by bulk carriers to aluminium
57 oxide refineries. In the second step at the aluminium refineries the Bayer Process is
58
59
60

1
2 applied to win aluminium oxide from the bauxite ore. As depicted in Figure A.1 the
3 mined bauxite is crushed and milled into a granule. The granule is dissolved under high
4 pressure in a pressure tank which is termed autoclave. For dissolving a sodium
5 hydroxide solution is used. Then, in filtrate procedures insoluble residues, containing
6 impurities and waste, defined as “red mud” are extracted so that sodium aluminate
7 remains. The sodium aluminate is alkaline and must be neutralized with substances
8 containing acid before processing. Then, it runs through another chemical crystallization
9 procedure and turns into aluminium hydroxide. Finally, aluminium oxide is obtained at
10 high temperatures from a rotary kiln which is a big furnace.
11
12
13
14
15
16
17

18
19
20
21 **Figure A.1**
22
23
24
25
26
27
28

29 In the third step, aluminium is made from aluminium oxide in a chemical electrolysis
30 procedure known as the Hall-Héroult Process (Figure A.2). In the Hall-Héroult Process
31 the aluminium oxide is smelted in a tank. Negatively charged particles, called anions,
32 wander to the positively charged electrodes (anode). Reversed, positively charged
33 particles, called cations, wander to the negatively charged electrode (cathode). Thereby,
34 liquid aluminium is separated from the molten aluminium oxide. The liquid aluminium
35 sinks to the ground of the tank from where it is suctioned.
36
37
38
39
40
41
42

43
44
45 **Figure A.2**
46
47
48
49
50
51

52 A more detailed description of both processes can be found in Cardarelli 2008, pp. 166-
53 169. In total, one metric ton of aluminium oxide is obtained from two metric tons of
54 bauxite and approximately 1.9 metric tons of aluminium oxide is converted into one
55 metric ton of aluminium. However, input-output relations can vary depending on
56 processes and qualities of intermediate products (Haas 1990, p. 49).
57
58
59
60

References

Almeder, C., Preusser, M. and Hartl, R.F., 2009. Simulation and optimization of supply chains: alternative or complementary approaches? *OR Spectrum*, 31 (1), 95–119.

Bilgen, B. and Ozkarahan, I., 2007. A mixed-integer linear programming model for bulk grain blending and shipping. *Int. J. Prod. Econ*, 107 (2), 555–571.

Brown, T.J., Bide, T., Hannis, S.D., Idoine, N.E., Hetherington, L.E., Shaw, R.A., Walters, A.S., Lusty, P.A.J., Kendall, R., 2010. World mineral production 2004-08, Keyworth, Nottingham: British Geological Survey.

Cardarelli, F., 2008. Materials Handbook, 2nd ed., London: Springer.

Chen, H.-Y.S., Lin, C.-W. R. and Yih, Y., 2007. Production-distribution network design of a global supply chain alliance from the key player's perspective. *Int. J. Prod. Res*, 45 (2), 245–265.

Dillenberger, C., Escudero, L.F., Wollensak, A. and Zhang, W., 1994. On practical resource allocation for production planning and scheduling with period overlapping setups. *Euro. J. Op. Res.*, 75 (2), 275–286.

Escudero, L.F. and Salmeron, J., 2005. On a Fix-and-Relax Framework for a Class of Project Scheduling Problems. *Ann. Op. Res.*, 140 (1), 163–188.

Ferreira, D., Morabito, R. and Rangel, S., 2009. Solution approaches for the soft drink integrated production lot sizing and scheduling problem. *Euro. J. Op. Res.*, 196, 697–706.

Ferretti, I., Zanoni, S., Zavanella, L. and Diana, A., 2007. Greening the aluminium supply chain. *Int. J. Prod. Econ.*, 108 (1-2), 236–245.

Haas, U., 1990. Standortperspektiven stromintensiver Produktionen in der Bundesrepublik Deutschland, Göttingen: Vandenhoeck&Ruprecht.

LINDO, 2008. LINGO – the modeling language and optimizer. Chicago: LINDO Systems Inc.

1
2
3 Ouhimmou, M., D'Amours, S., Beauregard, R., Ait-Kadi, D. and Singh Chauhan, S.,
4 2008. Furniture supply chain tactical planning optimization using a time decomposition
5 approach. *Euro. J. Op. Res.*, 189 (3), 952–970.
6
7

8
9 Stopford, M., 2009. *Maritime Economics*. London and New York: Routledge.
10

11
12 Tang, L. and Liu, G., 2007. A mathematical programming model and solution for
13 scheduling production orders in Shanghai Baoshan Iron and Steel Complex. *Euro. J.*
14 *Op. Res.*, 182 (3), 1453–1468.
15
16

17
18 van Hoesel, S., Romeijn, H.E., Morales, D.R. and Wagelmans, A.P.M., 2005. Integrated
19 lot sizing in serial supply chains with production capacities. *Manage. Sci.*, 51 (11),
20 1706–1719.
21
22

23
24 Weerts W., 2008. Inland work platform. In: Winter H., Hennig, C., Gerhard M., eds.
25 *Fundamentals of financing transportation*, Frankfurt: Bankakademie-Verlag, 883–905.
26
27
28
29
30
31
32
33
34
35
36
37
38
39
40
41
42
43
44
45
46
47
48
49
50
51
52
53
54
55
56
57
58
59
60

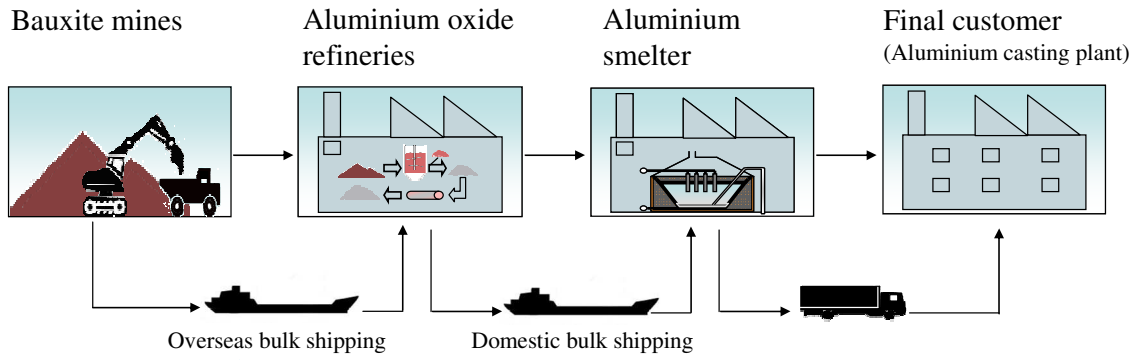

Figure 1. Production processes in the aluminium supply chain

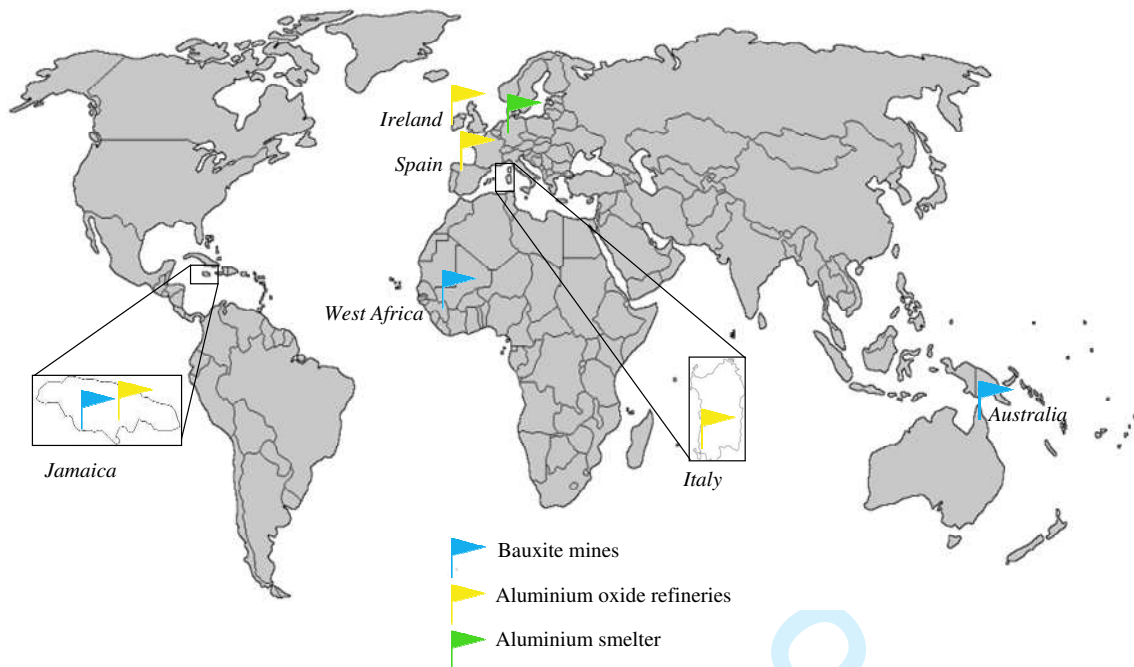

Figure 2. Sites of the aluminium supply chain network

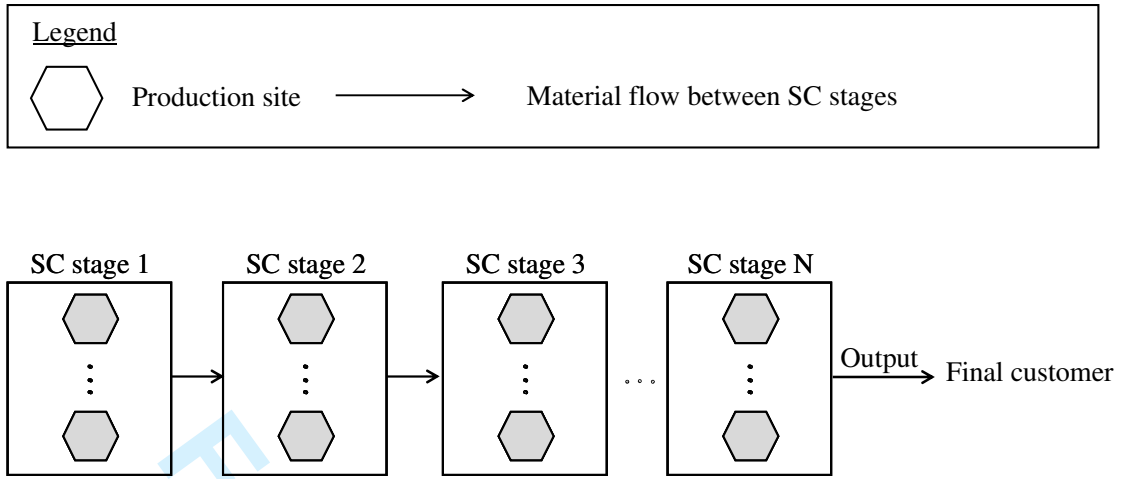

Figure 3. Macroperspective of a supply chain network

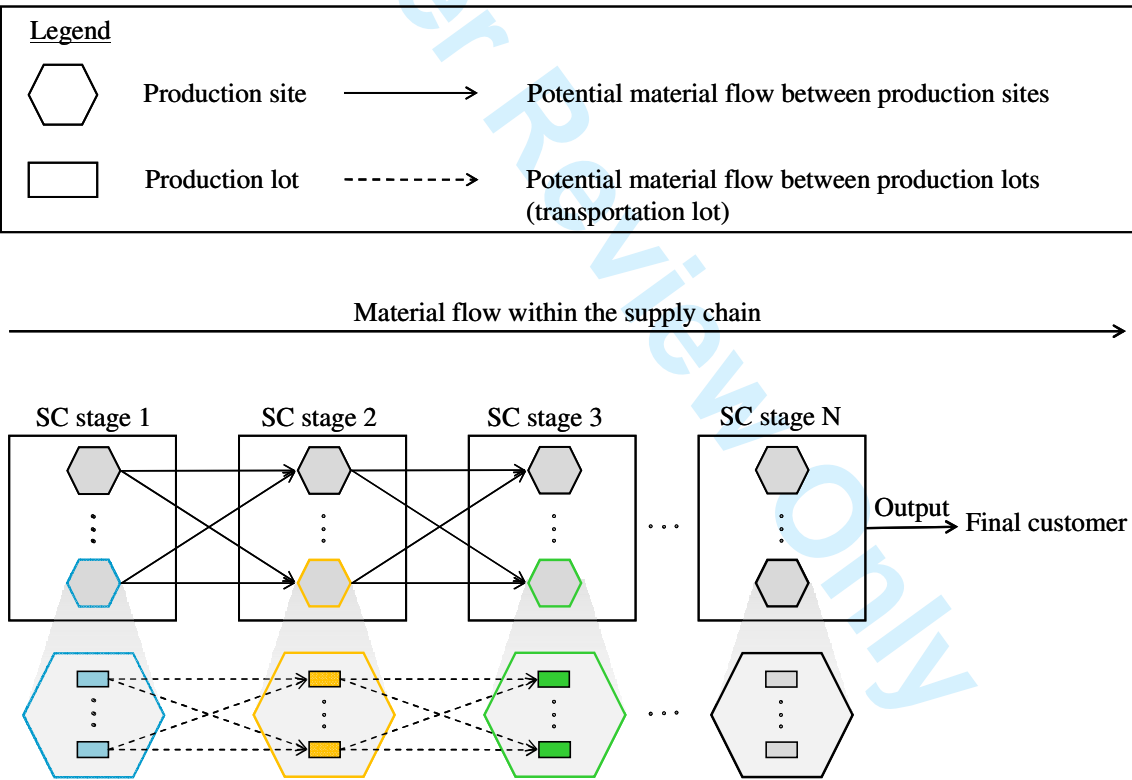

Figure 4. Microperspective and material flows in a supply chain network

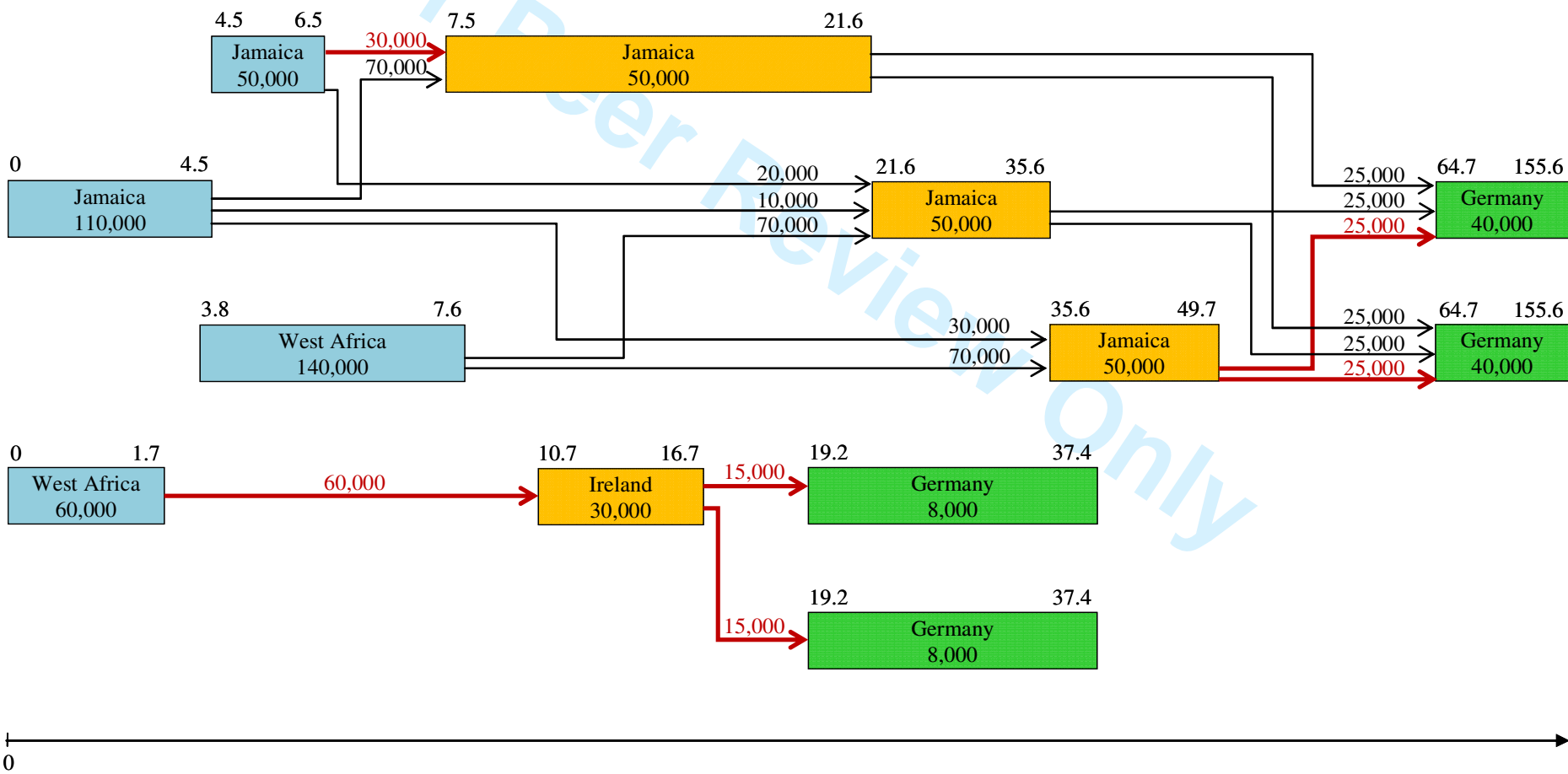
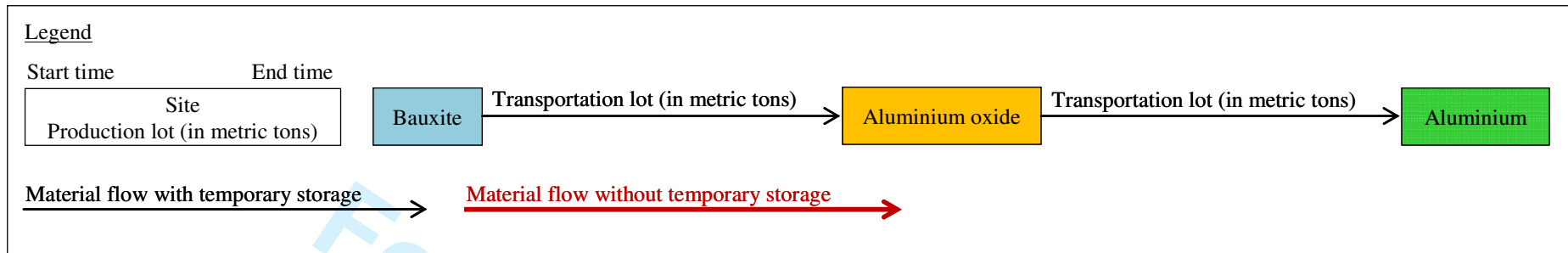

Figure 5. Production distribution and scheduling in the aluminium supply chain network

For Peer Review Only

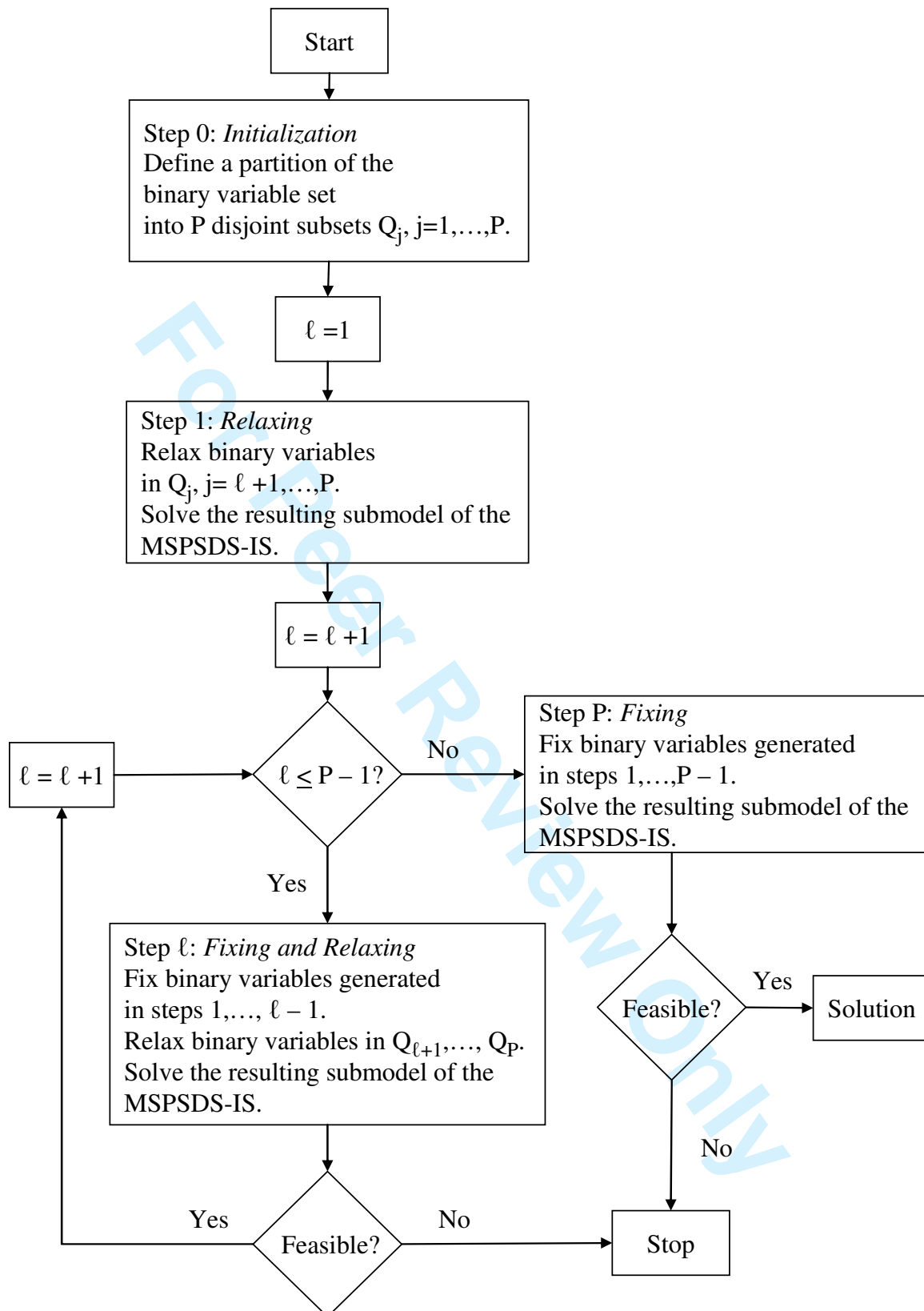

Figure 6. Basic solution procedure of RF heuristics

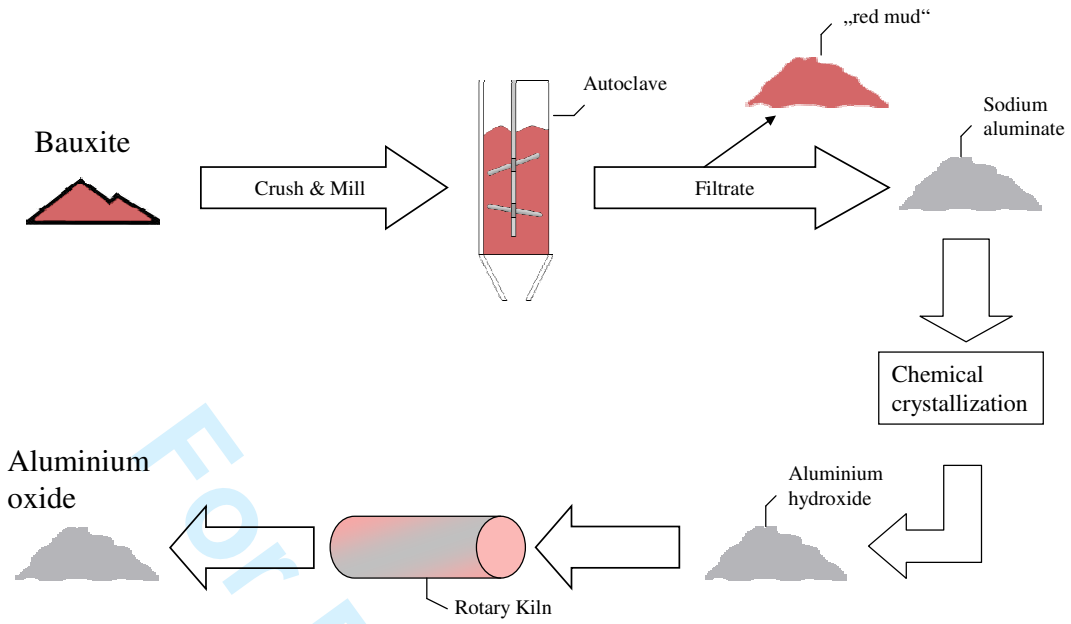

Figure A.1. Bayer Process

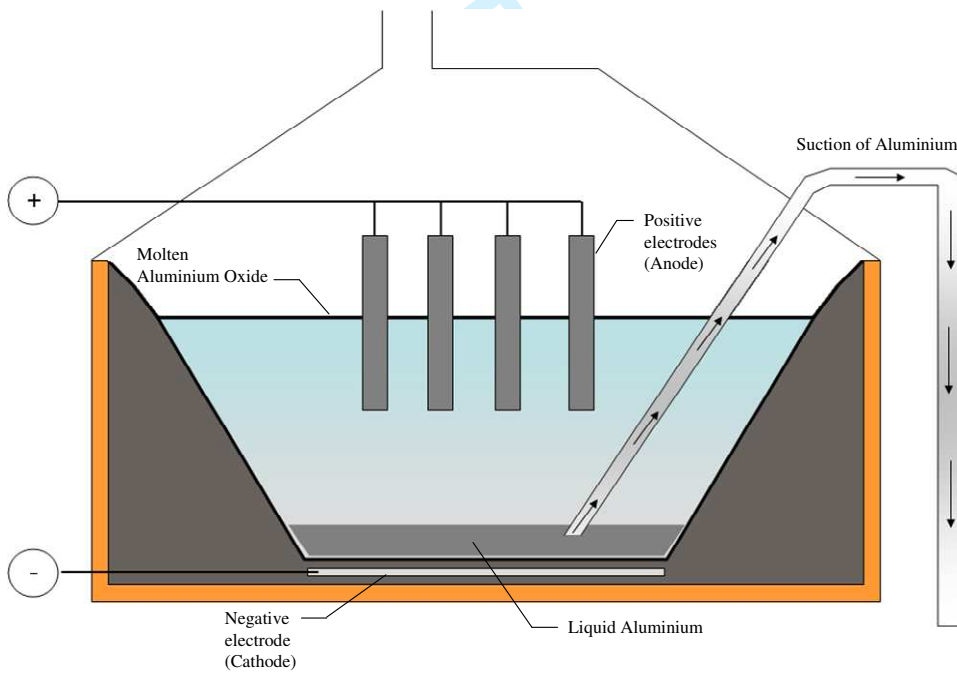

Figure A.2. Hall-Héroult Process

Table 1. Production data (bauxite mining)

	Australia	Jamaica	West Africa
Minimum production quantity (in metric tons)	60,000	25,000	35,000
Minimum size of production lots (in metric tons)	20,000	20,000	20,000
Maximum number of production lots	2	2	2

Table 2. Production data (aluminium oxide refining)

	Ireland	Italy	Jamaica	Spain
Minimum production quantity (in metric tons)	5,000	15,000	30,000	10,000
Minimum size of production lots (in metric tons)	5,000	5,000	5,000	5,000
Maximum number of production lots	3	3	3	3

Table 3. Production speeds (in metric tons / day)

Bauxite mining	Bauxite production
Australia	45,205
Jamaica	24,438
West Africa	36,055
Aluminium oxide refining	Aluminium oxide production
Ireland	4,932
Italy	2,740
Jamaica	3,562
Spain	4,027
Aluminium production	Aluminium production
Germany	440 metric tons / day (for each production line)

Table 4. Shipping times (in days)

From ... to ...	Ireland	Italy	Jamaica	Spain
Australia	31	32	37	28
Jamaica	13	18	1	15
West Africa	9	10	13	7
From ... to ...	Germany			
Ireland	2.5			
Italy	8			
Jamaica	15			
Spain	3			

Table 5. Variable production costs in US\$ / metric ton and shipment costs in US\$ / shipping (or US\$ / metric ton of bauxite [*])

Bauxite mining	Variable production costs (in US\$ / metric ton)	Shipping costs from...to...	Ireland	Italy	Jamaica	Spain
Australia	6.5	Australia	930,000	960,000	1,110,000	840,000
Jamaica	16.5	Jamaica	390,000	540,000	0.54[*]	450,000
West Africa	9.5	West Africa	270,000	300,000	390,000	210,000
Aluminium oxide refining	Variable production costs (in US\$ / metric ton)	Shipping costs from...to...	Germany			
Ireland	240	Ireland	52,700			
Italy	307	Italy	217,700			
Jamaica	176	Jamaica	427,700			
Spain	279	Spain	67,700			
Aluminium production	1,560 US\$ / metric ton (for each production line)					

Table 6. Computational results of data set 1

no.	bonus payments (US\$)	optimisation		RF heuristic S ₁ S ₂				RF heuristic S ₃ S ₄ S ₅			
		cost (US\$ millions)	computation time (hh:mm:ss)	cost (US\$ millions)	computation time (hh:mm:ss)	cost diff. (in %)	time diff. (in %)	cost (US\$ millions)	computation time (hh:mm:ss)	cost diff. (in %)	time diff. (in %)
1	100,000	155.6*	10:40:47	156.6	00:20:19	0.7	-96.8	157.3	00:13:50	1.1	-97.8
2	90,000	159.6*	23:05:30	160.5	00:25:22	0.6	-98.2	161.2	00:11:22	1.0	-99.2
3	80,000	163.5*	16:33:09	163.8	00:17:58	0.1	-98.2	163.9	00:12:07	0.2	-98.8
4	70,000	167.4*	108:13:31	167.6	00:09:54	0.1	-99.8	167.8	00:06:26	0.2	-99.9
5	60,000	171.2*	66:27:36	171.5	00:08:36	0.1	-99.8	171.3	00:03:00	< 0.1	-99.9
6	50,000	174.8*	28:58:23	174.9	00:03:22	0.1	-99.8	175.3	00:01:19	0.3	-99.9
7	40,000	178.2	56:06:27	178.3	00:01:39	0.1	< -99.9	178.8	00:00:51	0.3	< -99.9
8	30,000	181.6	34:02:24	181.7	00:01:48	0.1	-99.9	182.2	00:00:51	0.4	< -99.9
9	20,000	184.9	05:38:55	185.2	00:01:01	0.1	-99.7	185.2	00:00:34	0.1	-99.8
10	10,000	187.9	106:42:20	188.3	00:01:01	0.1	< -99.9	188.4	00:00:38	0.2	< -99.9
11	0	190.4	00:31:23	190.6	00:07:21	0.1	-76.6	190.6	00:05:00	0.1	-84.1

Table 7. Computational results of data set 2

no.	bonus payments (US\$)	optimisation		RF heuristic S ₁ S ₂				RF heuristic S ₃ S ₄ S ₅			
		cost (US\$ millions)	computation time (hh:mm:ss)	cost (US\$ millions)	computation time (hh:mm:ss)	cost diff. (in %)	time diff. (in %)	cost (US\$ millions)	computation time (hh:mm:ss)	cost diff. (in %)	time diff. (in %)
12	100,000	255.4	39:49:23	256.3	00:08:47	0.4	-99.6	264.6++	00:02:53	3.6	-99.9
13	90,000	258.7*	07:06:32	259.4	00:07:24	0.3	-98.3	268.3	00:01:39	3.7	-99.6
14	80,000	261.8	130:10:54	262.5	00:06:21	0.3	-99.9	269.9	00:03:28	3.1	< -99.9
15	70,000	265.0	35:10:06	265.7	00:07:11	0.3	-99.7	273.0	00:02:10	3.0	-99.9
16	60,000	268.1	99:11:01	268.8	00:06:56	0.3	-99.9	271.0	00:01:36	1.1	< -99.9
17	50,000	271.2	29:13:32	272.0	00:04:38	0.3	-99.7	272.4++	00:02:12	0.4	-99.9
18	40,000	274.3	33:20:41	275.1	00:05:55	0.3	-99.7	275.5	00:01:13	0.4	-99.9
19	30,000	277.4	83:17:55	278.3	00:04:47	0.3	-99.9	278.1	00:02:20	0.3	< -99.9
20	20,000	280.5	73:19:18	281.4	00:02:59	0.3	-99.9	280.8	00:01:36	0.1	< -99.9
21	10,000	283.2	32:40:30	283.6++	00:00:38	0.2	< -99.9	283.7	00:01:10	0.2	-99.9
22	0	283.7	00:16:36	283.7++	00:00:06	0	-99.4	284.8	00:02:02	0.4	-87.8

Table 8. Computational results of data set 3

no.	bonus payments (US\$)	optimisation		RF heuristic S ₁ S ₂				RF heuristic S ₃ S ₄ S ₅			
		cost (US\$ millions)	computation time (hh:mm:ss)	cost (US\$ millions)	computation time (hh:mm:ss)	cost diff. (in %)	time diff. (in %)	cost (US\$ millions)	computation time (hh:mm:ss)	cost diff. (in %)	time diff. (in %)
23	100,000	267.6	103:12:37	268.1	00:01:30	0.2	< -99.9	269.5++	00:00:55	0.7	< -99.9
24	90,000	270.7	44:45:37	271.2	00:01:04	0.2	< -99.9	272.7++	00:00:48	0.7	< -99.9
25	80,000	273.8	95:32:31	274.4	00:00:54	0.2	< -99.9	275.1++	00:00:44	0.5	< -99.9
26	70,000	277.0	92:56:15	277.4	00:00:56	0.2	< -99.9	279.1++	00:01:05	0.8	< -99.9
27	60,000	280.1	17:51:05	280.5	00:00:39	0.2	-99.9	281.0++	00:00:58	0.4	-99.9
28	50,000	283.2	19:19:36	283.4	00:00:30	0.1	< -99.9	283.8++	00:00:44	0.2	-99.9
29	40,000	286.1	05:14:01	286.2	00:00:18	< 0.1	-99.9	287.4++	00:00:51	0.4	-99.7
30	30,000	288.9	00:34:14	289.3	00:00:10	0.1	-99.5	289.2++	00:00:25	0.1	-98.8
31	20,000	291.6	00:14:02	291.6	00:00:07	< 0.1	-99.2	304.8++	00:00:18	4.5	-97.9
32	10,000	293.7	00:01:36	293.7	00:00:04	0	-95.8	293.7	00:00:04	0	-95.8
33	0	295.7	00:00:39	295.7	00:00:02	0	-94.9	295.7	00:00:02	0	-94.9

Table 9. Computational results of data set 4

no.	bonus payments (US\$)	optimisation		RF heuristic S ₁ S ₂				RF heuristic S ₃ S ₄ S ₅			
		cost (US\$ millions)	computation time (hh:mm:ss)	cost (US\$ millions)	computation time (hh:mm:ss)	cost diff. (in %)	time diff. (in %)	cost (US\$ millions)	computation time (hh:mm:ss)	cost diff. (in %)	time diff. (in %)
34	100,000	157.4*	62:12:42	159.3	02:32:08	1.2	-95.9	158.8++	00:17:39	0.9	-99.5
35	90,000	161.2*	73:47:30	161.6	01:43:04	0.2	-97.7	162.7++	00:17:31	0.9	-99.6
36	80,000	165.0*	26:36:38	165.4	01:26:20	0.2	-94.6	165.6++	00:18:30	0.4	-98.8
37	70,000	168.8*	85:09:06	169.2	00:38:19	0.2	-99.3	169.2++	00:11:28	0.2	-99.8
38	60,000	172.5*	111:25:38	173.0	00:36:22	0.3	-99.5	172.8++	00:09:16	0.1	-99.9
39	50,000	176.3*	23:27:05	176.6	00:22:38	0.2	-98.4	176.5++	00:07:47	0.1	-99.4
40	40,000	179.9*	51:51:57	180.1	00:08:39	0.1	-99.7	180.0++	00:02:21	0.1	-99.9
41	30,000	183.5	169:39:06	183.6	00:04:16	0.1	< -99.9	183.6++	00:01:11	< 0.1	< -99.9
42	20,000	186.6*	39:07:07	186.8	00:01:32	0.1	-99.9	187.0++	00:00:29	0.2	< -99.9
43	10,000	189.2	01:04:52	189.2	00:00:18	0	-99.5	189.3++	00:00:24	0.1	-99.4
44	0	191.2	00:00:03	191.3	00:00:09	0.1	200	191.2++	00:04:10	0	8233.3

++ Extended steps executed in addition to the basic solution procedure of the corresponding RF heuristic.

* An optimal solution could not be found after 170 hours of computation time. The computations were stopped and then restarted with the added constraint that the objective function value is smaller than or equal to the best objective function value found after 170 hours. The corresponding columns show only the computation times after restart until the optimal solution is found.